

Cross-Recess
Size #2

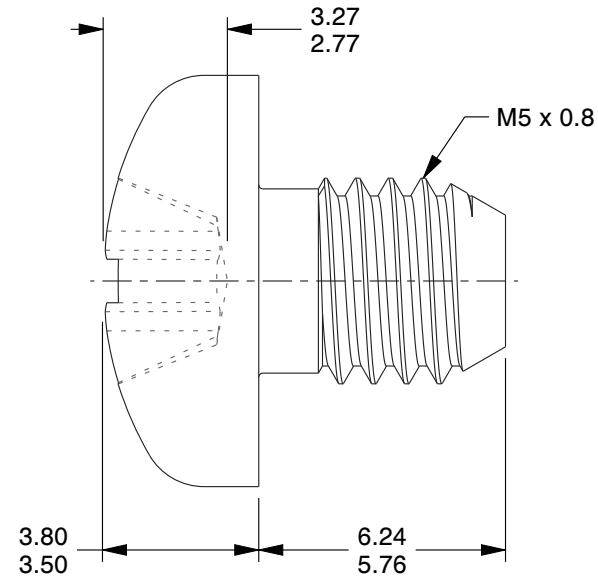

NOTES:

1. HEAD TYPE: Pan Head
2. MATERIAL: Property Class 4.8 Steel
3. FINISH: Zinc Plated
4. PACKAGE QTY: 100
5. TENSILE STRENGTH: 60,900
6. ROCKWELL HARDNESS: B71 to B99
7. STANDARD: Meets/Exceeds DIN 7985A

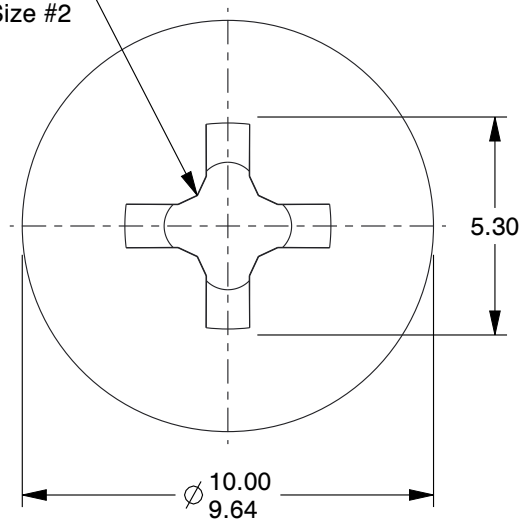

SCALE 1:1

COMPONENT	Machine Screw, Phillips
-----------	-------------------------



100 Grainger Parkway, Lake Forest, Illinois 60045-5201
1-(800) GRAINGER, 1-(800) 472-4643, (847) 535-1000
www.grainger.com

This file and any associated information and specifications are provided for reference and evaluation purposes only, and is subject to change without notice. Grainger makes no representations, warranties or guarantees as to the appropriateness, accuracy, completeness, or suitability for any purpose, of the file, information or specifications. You are solely responsible for the use of the file, information or specifications.

This drawing is the property of GRAINGER. It contains confidential, proprietary information that is GRAINGER property. Do not disclose to or duplicate for others except as authorized by GRAINGER.

SCALE 5.44

6GE82
Mach Screw, Pan, M5x0.80x6 L, PK100

UNIT
MM
SHEET
1 of 1