

Item	Hydraulic Gear Pump/Motor	Mounting	4F17 4 Bolt
Type	Birotational	Ports (Inlet)	7/8-14
Housing	Cast Iron	Ports (Outlet)	7/8-14
Rotation	Reversible	Shaft Extension (In.)	1/2 X 1 1/2 Keyed
Max. RPM	5000	Nominal GPM @ 1200 RPM	2.7

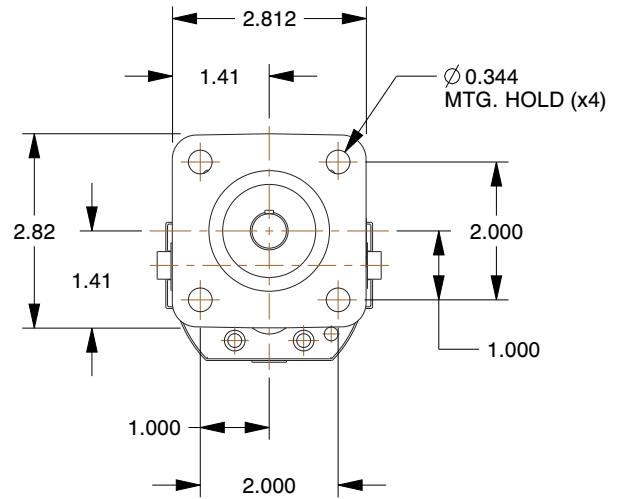
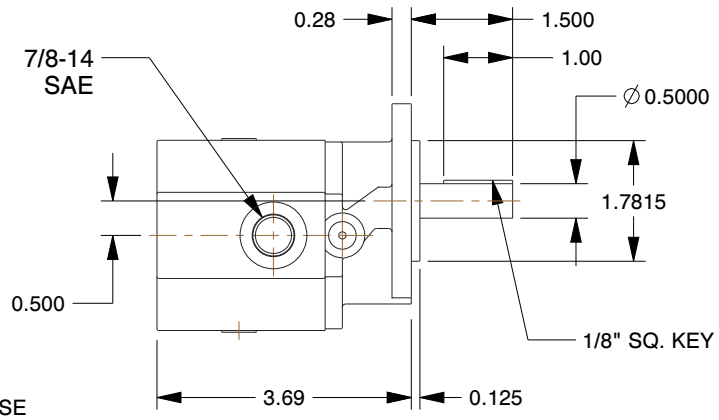
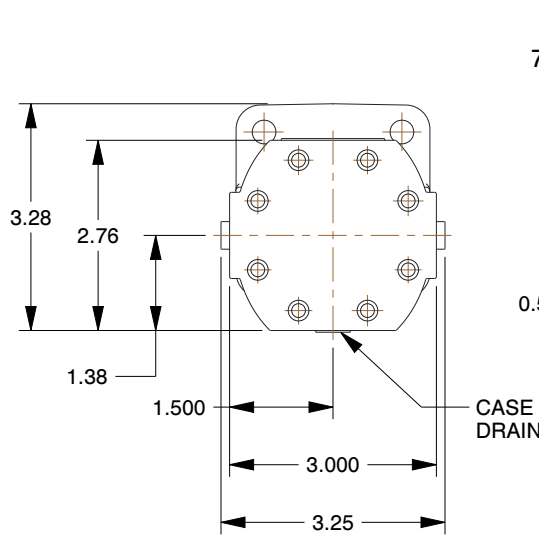

NOTES:

1. MAX. CONTINUOUS PSI: 2500
2. GPM @ 1800 RPM & 1000 PSI: 3.1
3. GPM @ 3600 RPM & 1000 PSI: 8.0
4. DISPLACEMENT (CU. IN./REV.): 0.517
5. MAX. INTERMITTENT PRESSURE (PSI): 2750
6. FEATURES: Viton Lip Seal and Reversing Check Valves to Avoid a Case Drain Port and Allow Bi-directional Usage

COMPONENT	Hydraulic Gear Pumps
-----------	----------------------



100 Grainger Parkway, Lake Forest, Illinois 60045-5201
 1-(800) GRAINGER, 1-(800) 472-4643, (847) 535-1000
 www.grainger.com

This file and any associated information and specifications are provided for reference and evaluation purposes only, and is subject to change without notice. Grainger makes no representations, warranties or guarantees as to the appropriateness, accuracy, completeness, or suitability for any purpose, of the file, information or specifications. You are solely responsible for the use of the file, information or specifications.

This drawing is the property of GRAINGER. It contains confidential, proprietary information that is GRAINGER property. Do not disclose to or duplicate for others except as authorized by GRAINGER.

SCALE 0.36

4F657
 Motor, Fluid, 3.1 GPM

UNIT	INCH
SHEET	1 of 1