

Series	Parker ST Series	Max. Pressure	1700 psi
Connection Type	FNPT	Coupler Finish	Plain
Coupler Body Size	3/4"	Bearing Material	Stainless Steel
Coupler Flow Rate	28.0 gpm	Locking Mechanism	Ball
Coupler Thread Size	3/4"-14	Coupler Body Material	Brass
Coupler Interchange Type	ST	Operating Temp. Range	-40° to 250°F

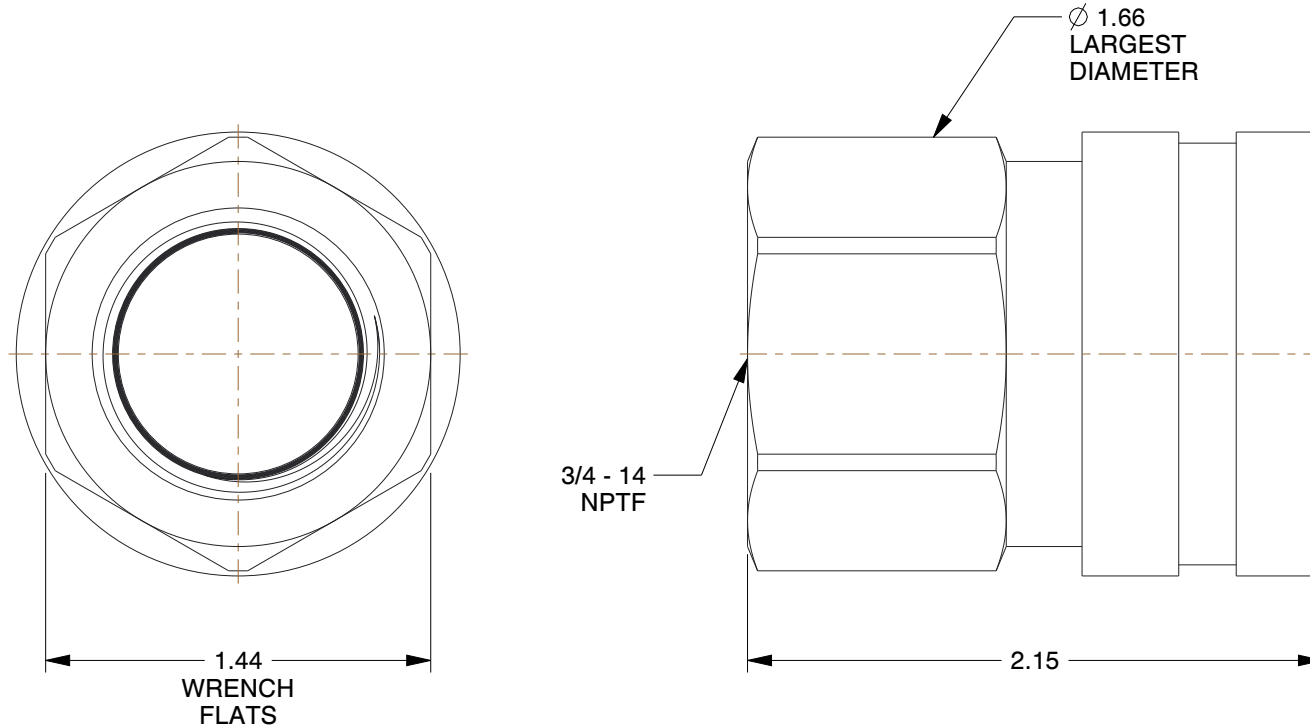

NOTES:

1. SEAL MATERIAL: Buna
2. INCLUDES: Sleeve Lock
2. ITEM: Hydraulic Coupler Body
3. FOR USE WITH: Parker ST Series
4. PARKER INTERCHANGE: BST-6
5. SLEEVE MATERIAL: 303 Stainless Steel
7. QUICK COUPLER TYPE: Hydraulic Coupler Body

COMPONENT	Hydraulic Quick Couplers
------------------	--------------------------



100 Grainger Parkway, Lake Forest, Illinois 60045-5201
 1-(800) GRAINGER, 1-(800) 472-4643, (847) 535-1000
 www.grainger.com

This file and any associated information and specifications are provided for reference and evaluation purposes only, and is subject to change without notice. Grainger makes no representations, warranties or guarantees as to the appropriateness, accuracy, completeness, or suitability for any purpose, of the file, information or specifications. You are solely responsible for the use of the file, information or specifications.

This drawing is the property of GRAINGER. It contains confidential, proprietary information that is GRAINGER property. Do not disclose to or duplicate for others except as authorized by GRAINGER.

SCALE 1.39

31A960	UNIT
	INCH
	SHEET
	1 of 1

Coupler Body,3/4-14,3/4 In. Body,Brass