



# 2100 Series

Flatbar Exit Devices



## rugged reliability

### introduction

It's no secret that the 2100 series flatbar exit device has a reputation as the right choice for meeting the rigors of demanding industry segments.

The quality and certified ANSI/BHMA A156.3 Grade 1 performance of the 2100 series are unmatched in the security industry. So it's no wonder that architects and specifiers request it for their toughest applications.

Patented mechanisms made of heavily electroplated high-grade steel and non-ferrous materials provide sturdy construction and superior protection against corrosion. High quality finishes of baked powder coatings resist rust and abrasion, with cosmetic and functional life extended to match that of the architectural finishes offered on the optional outside trim.

In an evolutionary move for the 2100 series devices, Yale also offers architectural-grade finishes. Architectural finishes add new dimensions of versatility to the 2100 series, making it a perfect fit for prominent entryways in office buildings, department stores, movie theaters and other venues that call for a blending of performance and style.

### ANSI/BHMA

Certified ANSI/BHMA A156.3, Grade 1.



### iso 9001

Designed and manufactured under a certified ISO 9001 quality system.

### fire listings

2100F series exit devices are UL-cUL Listed for use on fire doors having a rating up to and including 3-hours unless otherwise noted.

Note: Any retrofit or other field modification to a fire rated opening can potentially impact the fire rating of the opening, and Yale Locks & Hardware makes no representations or warranties concerning what such impact may be in any specific situation. When retrofitting any portion of an existing fire rated opening, or specifying and installing a new fire-rated opening, please consult with a code specialist or local code official (Authority Having Jurisdiction) to ensure compliance with all applicable codes and ratings.

### free wheeling lever trim

2100 exit device lever trims feature the unique Free



Wheeling Lever mechanism. This Free Wheeling trim features a clutch mechanism which allows the lever to float down 60° when operated in the locked condition, greatly improving vandal resistance.

### windstorm

Certified (refer to local codes). Specify suffix "WS" to 2100(F) devices.



### contents

- Introduction ..... 2
- Functions ..... 3
- Applications..... 4-5
- SquareBolt® and Rim..... 6-7
- Surface Vertical Rod ..... 8-9
- Concealed Vertical Rod ..... 10-11
- Trim Designs ..... 12
- Exit Device Trims..... 13-15
- Cylinders ..... 16-18
- Strikes..... 19
- Accessories..... 20-21
- Mullions ..... 22-23
- Stand-Alone Door Alarm ..... 24
- Facts and Figures ..... 25
- Ordering Information ..... 26
- Sample Specification ..... 27

### finishes

ANSI/BHMA Code	Finish Description
605	Bright Brass, Clear Coated
606	Satin Brass, Clear Coated
612	Satin Bronze, Clear Coated
613	Dark Oxidized Satin Bronze, Oil Rubbed <sup>1</sup>
630	Satin Stainless Steel 
689	Aluminum Painted
691	Light Bronze Painted
693	Black Painted
695	Dark Bronze Painted
722	Black Oxidized Bronze, Oil Rubbed <sup>2</sup>





















































<sup>1</sup> New May 1, 2010

<sup>2</sup> Formerly 613 prior to May 1, 2010



**Finish available with MicroShield® antimicrobial coating, additional finishes by special application. Consult factory for availability.**

## ansi functions

ANSI Function No.	Function Description	Trim Model Number	SquareBolt® (Type 1 or 28) 2150(F)	Rim (Type 1) 2100(F)	Surface Vertical Rod (Type 2) 2110(F) 2170(F90)	Concealed Vertical Rod (Type 7 & 8) 2120(F) 2160(F90)
01	Exit Only, No Trim/Exit Only, Blank Plate	620F 630F				
02	Pull to Open (Dummy Trim)	214F 448F <sup>1,2</sup> 449F <sup>1,2</sup> 588F <sup>1,2</sup> 589F <sup>1,2</sup> 624F 629F <sup>2</sup> 625F 634F <sup>2</sup> 628F <sup>1,2</sup>				
03	Key Retracts Latchbolts (NL)	121NL 213F 217F 441F <sup>2</sup> 581F <sup>2</sup> 621F 623F 632F <sup>2</sup> 631F 632F <sup>2</sup> 634F <sup>2</sup>				
05	Entrance by Thumbpiece (Key Locks/ Unlocks Thumbpiece)	633F				
06	Key Unlocks Thumbpiece (Key Removable When Locked)	633F <sup>1</sup>				
08	Entrance by Knob (Key Locks/Unlocks Knob)	622F				
08	Entrance by Lever (Key Locks/Unlocks Lever)	446F <sup>2</sup> 586F <sup>2</sup> 626F <sup>2</sup>				
09	Key Unlocks Knob (Key Removable When Locked)	622F <sup>1</sup>				
09	Key Unlocks Lever (Key Removable When Locked)	626F <sup>1,2</sup>				
11	Cylinder Controls Thumbturn	603F				
12	Key & Thumbturn (Key Removable When Locked)					
14	Knob Always Active (Passage)	624F				
14	Lever Always Active (Passage)	448F <sup>2</sup> 588F <sup>2</sup> 628F <sup>2</sup>				
15	Thumbpiece Always Active (Passage)	635F				

Sectional dummy trim (02) features levers that will turn, but will not operate the devices. For rigid lever use AU629F, or AU449F. Illustrations show typical function features, rather than pictorial renderings of the trims listed. Specific trim details are shown on pages 13-15.

<sup>1</sup> Trims require an easy field change to adapt them for the charted function. <sup>2</sup> ADA compliant trim. <sup>3</sup> Application not recommended

## applications

Single Door	UL Listing	Maximum Opening	Application
<b>SquareBolt®</b>			
2150	Panic	4' x *	Surface applied; single-point latching.
2150F	3 Hr.	4' x 8'	
<b>Rim</b>			
2100	Panic	4' x *	Surface applied; single-point latching.
2100F	3 Hr.	4' x 8'	
2100WS	Panic	3' x 7'	Surface applied; single-point latching. Used as components in swinging door windstorm-rated assemblies (refer to local codes).
2100FWS	3 Hr.	3' x 7'	
<b>Surface Vertical Rod</b>			
2110	Panic	4' x 10'	Surface applied; two-point latching.
2170	Panic	4' x 10'	
2170 x LBR	Panic	4' x 10'	Surface applied; one-point latching.
<b>Concealed Vertical Rod</b>			
2120	Panic	4' x 10'	Rods concealed in door; two-point latching
2160	Panic	4' x 10'	
2160 x LBR	Panic	4' x 10'	Rods concealed in door; one-point latching

\*UL does not set a door height limitation on panic applications.

Pair of Doors with Removable Mullion	UL Listing	Maximum Opening	Application
<b>SquareBolt® x SquareBolt®</b>			
2150 x 2150 x M200	Panic	8' x 10'	Two independent active doors with removable mullion.
2150F x 2150F x M200F	3 Hr.	8' x 8'	
<b>Rim x Rim</b>			
2100 x 2100 x M200	Panic	8' x 10'	Two independent active doors with removable mullion.
2100F x 2100F x M200F	3 Hr.	8' x 8'	

Pair of Doors with Keyed Removable Mullion	UL Listing	Maximum Opening	Application
<b>SquareBolt® x SquareBolt®</b>			
2150 x 2150 x KRM200	Panic	8' x 10'	Two independent active doors with removable mullion.
2150F x 2150F x KRM200F	3 Hr.	8' x 8'	
<b>Rim x Rim</b>			
2100 x 2100 x KRM200	Panic	8' x 10'	Two independent active doors with removable mullion.
2100F x 2100F x KRM200F	3 Hr.	8' x 8'	

## applications

Pair of Doors	UL Listing	Maximum Opening	Application	
<b>SquareBolt® x Surface Vertical Rod</b>				
2150 x 2110	Panic	8' x 10'	Two independent doors with two-point latching, swinging in the same direction.	
2150 x 2170	Panic	8' x 10'	Two independent doors with one- or two-point latching, swinging in the same direction.	
<b>Rim x Surface Vertical Rod</b>				
2100 x 2110	Panic	8' x 10'	Two independent doors with two-point latching, swinging in the same direction.	
2100 x 2170	Panic	8' x 10'	Two independent doors with one- or two-point latching, swinging in the same direction.	
<b>Surface Vertical Rod</b>				
2110 x 2110	Panic	8' x 10'	Two independent doors with two-point latching, swinging in the same direction.	
2110F x 2110F	3 Hr.	8' x 8'		
2170 x 2170	Panic	8' x 10'	Two independent doors with one- or two-point latching, swinging in the same direction.	
2170F90 x 2170F90	1-1/2 Hr.	8' x 10'		
2170F x 2170F	3 Hr.	8' x 8'		
<b>Surface Vertical Rod (Double Egress)</b>				
2110 x 2110	Panic	8' x 10'	Two independent doors with two-point latching, swinging in opposite directions. Overlapping astragal required for 3-hour openings.	
2110F x 2110F	3 Hr.	8' x 8'		
2170 x 2170	Panic	8' x 10'	Two independent doors with one- or two-point latching, swinging in opposite directions. Overlapping astragal not required.	
2170F90 x 2170F90	1-1/2 Hr.	8' x 10'		
2170F x 2170F	3 Hr.	8' x 8'		
<b>Concealed Vertical Rod</b>				
2120 x 2120	Panic	8' x 10'	Two independent metal doors with two-point latching, swinging in the same direction.	
2120F x 2120F	3 Hr.	8' x 8'		
2160 x 2160	Panic	8' x 10'	Two independent metal or wood doors with one- or two-point latching, swinging in the same direction.	
2160F90 x 2160F90	1-1/2 Hr.	8' x 10'		
2160F x 2160F	3 Hr.	8' x 8'		
<b>Concealed Vertical Rod (Double Egress)</b>				
2120 x 2120	Panic	8' x 10'	Two independent metal doors with two-point latching, swinging in opposite directions. Overlapping astragal required for 3-hour openings.	
2120F x 2120F	3 Hr.	8' x 8'		
2160 x 2160	Panic	8' x 10'	Two independent metal or wood doors with one- or two-point latching, swinging in opposite directions. Overlapping astragal not required.	
2160F90 x 2160F90	1-1/2 Hr.	8' x 10'		
2160F x 2160F	3 Hr.	8' x 8'		



# SquareBolt®

2150(F)

Just as easy to open as traditional latchbolts, the SquareBolt® exit device's unique construction offers innovative protection. Its patented *SquareBolt* (Pat. no. 5,605,362) design presents an improved physical barrier over standard rim latchbolts. The *SquareBolt* exit device locks into place and stays there. Credit cards, crowbars, door rattling and shaking are resisted, significantly reducing the threat of unauthorized entry.

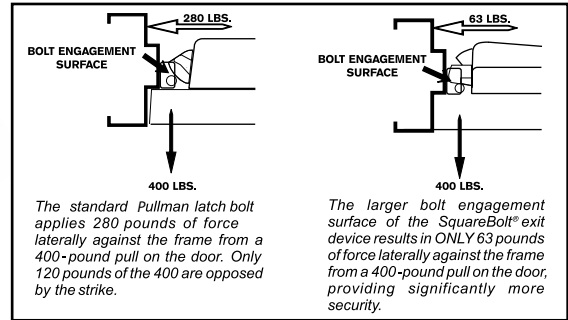

## certification/compliance

UL/cUL Listed: FVSR/FVSR7 - Panic hardware  
GXHX/GXHX7 - Fire exit hardware (F)  
(4' x 8' single, 8' x 8' pairs, 3 hr.)

ANSI/BHMA Certified: A156.3 Type 1 or 28, Grade 1 **BHMA CERTIFIED**  
U.S. Patent #: 5,605,362

## features

- Patented *SquareBolt* security deadbolt (Pat. no. 5,605,362) designed for maximum holding power
- Designed for wide stile doors
- Non-handed for easy installation
- Steel interlock "E" bracket maintains door-to-mullion relationship in fire-labeled devices
- Available certified as part of a hurricane resistant assembly (refer to local codes). Specify 2150(F)WS.  Hurricane

## applications

- Single swing doors
- Pairs of doors (mullion required)
- Metal, wood or composite door materials

## specifications

- Door Opening Width: -36 for 30" - 36" (76cm - 91cm) doors  
-42 for 36" - 42" (91cm - 107cm) doors  
-48 for 42" - 48" (107cm - 122cm) doors
- Door Thickness: 1-3/4" (44mm) standard. Optional door thicknesses available to 4-1/2"; specify door thickness when ordering.
- Minimum Stile Width: 4-1/2" (114mm)
  - Projection: 2-1/2" (64mm) active, 1-3/4" (44mm) depressed
  - Deadbolt: Patented 1" (25mm) slide projection bolt with full 3/4" (19mm) projection
  - Strike: 757F, 793 optional (double door application, panic only)
- Fasteners: Machine screws and wood door fasteners standard for panic hardware. Sex nuts and bolts supplied standard for fire exit hardware.
- Trims: 121NL cylinder only, 210F series utility trim, 440F series rose trim, 580F series rose trim with escutcheon plate, 620F series escutcheon trim, 630F series pull/thumbpiece trim. See pages 13-15.
- Dogging: Hex key dogging supplied standard on panic devices
- Finishes: 605, 606, 612, 613, 630, 689, 691, 693, 695, 722
- Options: Cylinder dogging, shim kit #223, sex nuts and bolts, MicroShield®
- Warranty: 3-year limited

## rim

### 2100(F)

The 2100(F) is a rim exit device to be used with single doors or pairs of doors constructed of metal, wood or composite materials. The 2100(F) can be paired with a wide variety of trims to meet many applications.



### certification/compliance

UL/cUL Listed: FVSR/FVSR7 - Panic hardware  
 GXHX/GXHX7 - Fire exit hardware (F)  
 (4' x 8' single, 8' x 8' pairs, 3 hr.)  
 ZHEM - Latching hardware  
 ZHLA - Windstorm rated assemblies

ANSI/BHMA Certified: A156.3 Type 1, Grade 1



### features

- Designed for wide stile doors
- Non-handed for easy installation
- Steel interlock "E" bracket maintains door-to-mullion relationship in fire-labeled devices
- Deadlocking pullman latchbolt positively engages roller strike
- Available certified hurricane resistant (refer to local codes). Specify 2100(F)WS  Hurricane

### applications

- Single swing doors
- Pairs of doors (mullion required)
- Metal, wood or composite door materials

### specifications

Door Opening Width:	-36 for 30" - 36" (76cm - 91cm) doors -42 for 36" - 42" (91cm - 107cm) doors -48 for 42" - 48" (107cm - 122cm) doors
Door Thickness:	1-3/4" (44mm) standard. Optional door thicknesses available to 4-1/2"; specify door thickness when ordering.
Minimum Stile Width:	4-1/2" (114mm)
Projection:	2-1/2" (64mm) active, 1-3/4" (44mm) depressed
Latchbolt:	3/4" (19mm) deadlocking stainless steel pullman-type
Strike:	757F, 793 optional (double door application, panic only)
Fasteners:	Machine screws and wood door fasteners standard for panic hardware. Sex nuts and bolts supplied standard for fire exit hardware.
Trims:	121NL cylinder only, 210F series utility trim, 440F series rose trim, 580F series rose trim with escutcheon plate, 620F series escutcheon trim, 630F series pull/thumbpiece trim. See pages 13-15.
Dogging:	Hex key dogging supplied standard on panic devices
Finishes:	605, 606, 612, 613, 630, 689, 691, 693, 695, 722
Options:	Cylinder dogging, shim kit #223, sex nuts and bolts, MicroShield®
Warranty:	3-year limited

## surface vertical rod

### 2110(F)

The 2110(F) is a surface vertical rod exit device to be used on metal, wood or composite pairs of doors up to 8' (fire) and 10' (panic) where two-point latching is desired.

### certification/compliance

UL/cUL Listed: FVSR/FVSR7 - Panic hardware  
GXHX/GXHX7 - Fire exit hardware (F)  
(8' x 8' pairs, 3 hr.)

ANSI/BHMA

Certified: A156.3 Type 2, Grade 1 

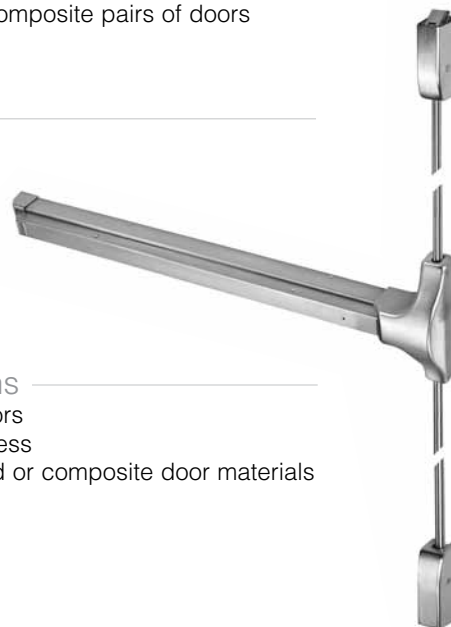

### features

- Designed for wide stile doors
- Handed, specify hand (field reversible)
- Positive action linkage on a deadlocking top pullman bolt
- Simultaneous direct pull bottom deadbolt
- When unlatched, device keeps both bolts retracted until door is shut

### applications

- Pairs of doors
- Double egress
- Metal, wood or composite door materials

### specifications

Door Opening Width:	-36 for 30" - 36" (76cm - 91cm) doors -42 for 36" - 42" (91cm - 107cm) doors -48 for 42" - 48" (107cm - 122cm) doors
Door Opening Height:	Standard door height 7' (213cm), with the device centerline at 39-15/16" (101cm) from floor. Optional heights up to 8' (fire) and 10' (panic) available by using rod extensions. For fire rated openings over 8', see 2170F SVR.
Door Thickness:	1-3/4" (44mm) standard. Optional door thicknesses available to 4-1/2"; specify door thickness when ordering.
Minimum Stile Width:	4-1/2" (114mm)
Projection:	2-1/2" (64mm) active, 1-3/4" (44mm) depressed
Latchbolt:	Top: 3/4" (19mm) throw, pullman-type with automatic deadlatching. Bottom: 5/8" (16mm) throw deadbolt, held retracted during door swing.
Vertical Rods:	1/2" (13mm) O.D. tubular brass, bronze or stainless steel with rod guides
Strike:	Top: Roller type 791. Bottom: Flush mounted 790. 794 floor strike optional (threshold openings).
Fasteners:	Machine screws and wood door fasteners standard for panic hardware. Sex nuts and bolts supplied standard for fire exit hardware.
Trims:	210F series utility trim, 440F series rose trim, 580F series rose trim with escutcheon plate, 620F series escutcheon trim, 630F series pull/thumbpiece trim. See pages 13-15.
Dogging:	Hex key dogging supplied standard on panic devices
Finishes:	605, 606, 612, 613, 630, 689, 691, 693, 695, 722
Options:	Cylinder dogging, shim kit #224, sex nuts and bolts, bottom pullman latch (panic only), MicroShield®
Warranty:	3-year limited



## surface vertical rod

### 2170(F)

The 2170(F) is a surface vertical rod exit device to be used on wide stile and flush doors up to 10' where one or two-point latching is desired. A Less Bottom Rod (LBR) option is available.

### certification/compliance

UL/cUL Listed: FVSR/FVSR7 - Panic hardware  
GXHX/GXHX7 - Fire exit hardware (F) (8' x 10' pairs, 1-1/2 hr.) (8' x 8' pairs, 3 hr.)

ANSI/BHMA

Certified: Certified A156.3 Type 2, Grade 1 

### features

- Designed for wide stile and flush doors
- Mechanisms made of heavily electroplated high-grade steel and non-ferrous materials provide sturdy construction and superior protection against corrosion
- Interlocking top strike and latch mounting plate for added stability
- Handed, specify hand (field reversible)
- Available less bottom rod (LBR option)

### applications

- Pairs of doors
- Double egress
- Metal, wood, or composite door materials

### specifications

Door Opening Width:	-36 for 30" - 36" (76cm - 91cm) doors -42 for 36" - 42" (91cm - 107cm) doors -48 for 42" - 48" (107cm - 122cm) doors
Door Opening Height:	Standard door height 7' (213cm), with the device centerline at 39-15/16" (101cm) from floor. Optional heights specify suffix -8, -9, -10.
Door Thickness:	1-3/4" (44mm) standard. Optional door thicknesses available to 4-1/2"; specify door thickness when ordering.
Minimum Stile Width:	4-1/2" (114mm)
Projection:	2-1/2" (64mm) active, 1-3/4" (44mm) depressed
Latchbolt:	Top: 3/4" (19mm) throw, pullman-type with automatic deadlatching. Bottom: 5/8" (16mm) throw deadbolt, held retracted during door swing.
Vertical Rods:	1/2" (13mm) O.D. tubular brass, bronze or stainless steel with rod guides
Strike:	Top: 726. Bottom: Flush-mounted 790. 794 floor strike optional (threshold openings).
Fasteners:	Machine screws and wood door fasteners standard for panic hardware. Sex nuts and bolts supplied standard for fire exit hardware.
Trims:	210F series utility trim, 440F series rose trim, 580F series rose trim with escutcheon plate, 620F series escutcheon trim, 630F series pull/thumbpiece trim. See pages 13-15.
Dogging:	Hex key dogging supplied standard on panic devices
Finishes:	605, 606, 612, 613, 630, 689, 691, 693, 695, 722
Options:	Cylinder dogging, shim kit #223, sex nuts and bolts, bottom pullman latch (panic only), less bottom rod (LBR), -8, -9, -10 opening height, rod extensions, MicroShield®
Warranty:	3-year limited

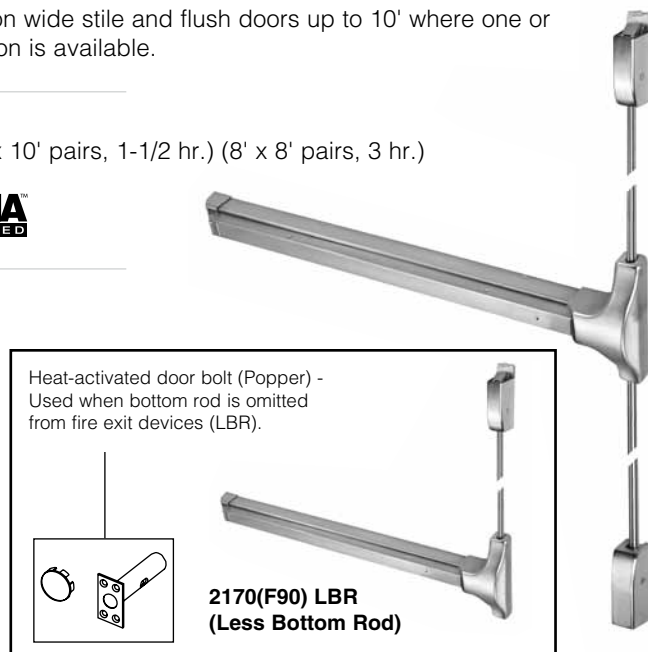

## concealed vertical rod

### 2120(F)

The 2120(F) is a concealed vertical rod exit device to be used on metal doors only up to 8' (fire) and 10' (panic) where two-point latching is desired.

### certification/compliance

UL/cUL Listed: FVSR/FVSR7 - Panic hardware  
 GXHX/GXHX7 - Fire exit hardware (F)  
 (8' x 8' pairs, 3 hr.)

ANSI/BHMA

Certified: A156.3 Grade 1, Type 8, Grade 1

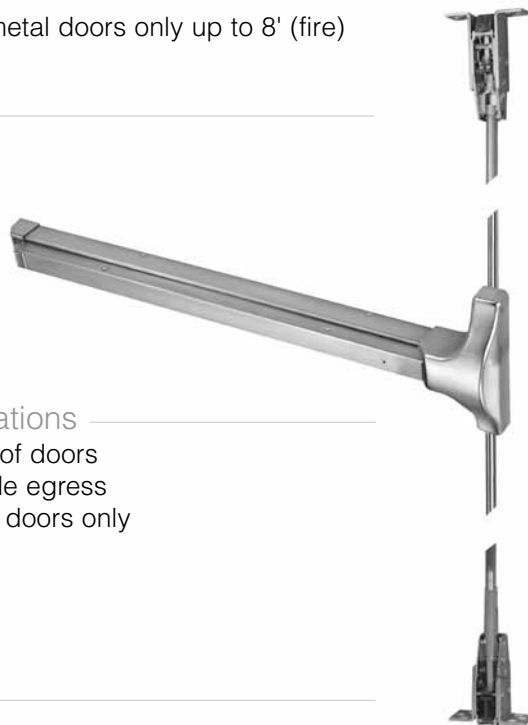

### features

- Designed for wide stile doors
- Handed, specify hand (field reversible)
- Positive action linkage on a deadlocking top pullman bolt
- Simultaneous direct pull bottom deadbolt
- When unlatched, device keeps both bolts retracted until door is shut

### applications

- Pairs of doors
- Double egress
- Metal doors only

### specifications

Door Opening Width:	-36 for 30" - 36" (76cm - 91cm) doors -42 for 36" - 42" (91cm - 107cm) doors -48 for 42" - 48" (107cm - 122cm) doors
Door Opening Height:	Standard door height adjustable to 8' (244cm), with the device centerline at 39-15/16" (101cm) from floor. Optional heights up to 10' (panic) available by using rod extensions. For fire rated openings over 8', see 2160F CVR.
Door Thickness:	1-3/4" (44mm) standard. 2" and 2-1/4" (51mm and 57mm) optional; specify when ordering.
Minimum Stile Width:	4-1/2" (114mm)
Projection:	2-1/2" (64mm) active, 1-3/4" (44mm) depressed
Latchbolt:	Top: 3/4" (19mm) throw, pullman-type with automatic deadlatching Bottom: 5/8" (16mm) throw deadbolt, held retracted during door swing
Vertical Rods:	1/2" (13mm) O.D. telescoping tubular rods
Strike:	Top: Roller type 791. Bottom: Flush mounted 790. 794 floor strike optional (threshold openings).
Fasteners:	Machine screws standard for panic hardware. Sex nuts and bolts supplied standard for fire exit hardware.
Trims:	210F series utility trim, 440F series rose trim, 580F series rose trim with escutcheon plate, 620F series escutcheon trim, 630F series pull/thumbpiece trim. See pages 13-15.
Dogging:	Hex key dogging supplied standard on panic devices
Finishes:	605, 606, 612, 613, 630, 689, 691, 693, 695, 722
Options:	Cylinder dogging, shim kit #223, sex nuts and bolts, bottom pullman latch (panic only), MicroShield®
Warranty:	3-year limited

## concealed vertical rod

### 2160(F)

The 2160(F) is a concealed vertical rod exit device to be used on wood and metal doors up to 10' where one or two-point latching is desired. A Less Bottom Rod (LBR) option is available.

### certification/compliance

UL/cUL Listed: FVSR/FVSR7 - Panic hardware

GXHX/GXHX7 – Fire exit hardware (F) (8' x 10' pairs, 1-1/2 hr.) (8' x 8' pairs, 3 hr.)

ANSI/BHMA

Certified: Certified A156.3 Type 7 and 8, Grade 1



### features

- Designed for wide stile and flush doors
- Mechanisms made of heavily electroplated high-grade steel and non-ferrous materials provide sturdy construction and superior protection against corrosion
- Handed, specify hand (field reversible)
- Available less bottom rod (LBR option)

### applications

- Pairs of doors
- Double egress
- Metal, wood, or composite door materials

### specifications

Door Opening Width: -36 for 30" - 36" (76cm - 91cm) doors  
 -42 for 36" - 42" (91cm - 107cm) doors  
 -48 for 42" - 48" (107cm - 122cm) doors

Door Opening Height: Standard door height adjustable to 8' (244cm), with the device centerline at 39-15/16" (101cm) from floor. Optional heights specify suffix -9, -10.

Door Thickness: 1-3/4" (44mm) standard. 2" and 2-1/4" (51mm and 57mm) optional; specify when ordering.

Minimum Stile Width: 4-1/2" (114mm)

Projection: 2-1/2" (64mm) active, 1-3/4" (44mm) depressed

Latchbolt: Top: 3/4" (19mm) throw, pullman-type with automatic deadlatching  
 Bottom: 5/8" (16mm) throw deadbolt, held retracted during door swing

Vertical Rods: 1/2" (13mm) O.D. telescoping tubular rods

Strike: Top: Mortised 761.

Bottom: Flush-mounted 790. 794 floor strike optional (threshold openings).

Fasteners: Machine screws and wood door fasteners standard for panic hardware. Sex nuts and bolts supplied standard for fire exit hardware.

Trims: 210F series utility trim, 440F series rose trim, 580F series rose trim with escutcheon plate, 620F series escutcheon trim, 630F series pull/thumbpiece trim. See pages 13-15.

Dogging: Hex key dogging supplied standard on panic devices

Finishes: 605, 606, 612, 613, 630, 689, 691, 693, 695, 722









Options: Cylinder dogging, shim kit #223, sex nuts and bolts, bottom pullman latch (panic only), less bottom rod (LBR), -9, -10 opening height, rod extensions, MicroShield®

Warranty: 3-year limited



## trim designs for escutcheons

























## standard

<b>Arcadia AR</b>   Projection: 3-1/4" (82mm)	<b>Augusta AU</b>   Projection: 2-5/8" (61mm)	<b>Carmel CR</b>   Projection: 3-1/8" (79mm)	<b>Jefferson JN</b>   Projection: 2-9/16" (65mm)
<b>Monroe MO</b>   Projection: 3" (76mm)	<b>Pacific Beach PB</b>   Projection: 3-5/16" (84mm)	<b>Pinehurst PN</b>   Projection: 3-1/16" (78mm)	<b>Virginia VI</b>   Projection: 3-1/8" (79mm)
<b>Hampton HA</b>   Projection: 3-3/8" (86mm)	<b>Copenhagen CO</b>  Projection: 3-1/2" (90mm)	<b>Litchfield LF</b>  Projection: 2-7/8" (73mm)	

Note: Projection dimensions are provided using the 620F series escutcheon plates.

## Reflections®



	TB	UB	TC	UC					
<b>Hudson</b> Projection									
	TE	TI							
<b>Danube</b> Projection									
	TG	TO	TJ	TK					
<b>Seine</b> Projection									
	TM	TN	TP	TR	TS	TQ			
<b>Thames</b> Projection									
	TT	TU	TV	TW	UW	TX	UX	TU	TZ
<b>Victoria</b> Projection									

Note: Projection dimensions are provided using the 620F series escutcheon plates.

## exit device trims

### 620F series wide escutcheon trim

- Certified ANSI/BHMA A156.3, Grade 1.
- Trim through-bolts to exit device for strength.
- Beveled sides improve attack resistance.
- Solid forged escutcheon and Free-Wheeling trim resists vandalism and abuse.
- Flush cylinder in 6-pin applications for additional security.
- 1-3/4" (44mm) door standard. For doors through 2-1/4" (57mm) or shim-mounted devices, specify on order.
- Dimensions: 3" x 10-1/4" x 13/16" (76mm x 260mm x 19mm).
- Cylinders not included. See page 16 for cylinder options.
- Available with AR, AU, CR, JN, MO, PB, PN, VI, HA lever designs and CO, LF knob designs. See page 12.
  - Finishes: 605, 606, 612, 613, 626, 630, 689, 691, 693, 695, 722
- Available with Reflections® lever designs. See page 12.
  - Finishes: 605, 606, 612, 613, 626, 630, 722
- Trim ordering example: AU626F x 626 x RHR.
- 5-year limited warranty.

Application	Cylinder	Classroom/ Storeroom Cylinder Controls Thumbturn	Exit Only Blank Plate	Nightlatch Access by Key	Classroom/ Storeroom Cylinder Controls Knob	Nightlatch Cylinder by Knob	Passage Active Knob	Dummy Trim Rigid Knob	Classroom Cylinder Controls Lever	Storeroom Cylinder Controls Lever	Nightlatch Cylinder by Lever	Passage	Dummy Trim Free-Wheeling	Dummy Rigid Lever
2100(F) 2150(F) 2110(F) 2120(F) 2160(F) 2170(F)	Rim	603F <sup>1</sup>	620F	621F <sup>2</sup>	622F <sup>1</sup>	623F <sup>2</sup>	624F	625F	626F	626F <sup>1</sup>	627F <sup>2</sup>	628F	628F <sup>1</sup>	629F
ANSI		11/12	01	03	08/09	03	14	02	08	09	03	14	02	02

<sup>1</sup> 09, 12 and Free Wheeling 02 achieved with single trim modification at installation.  
<sup>2</sup> Not recommended for use with vertical rod exit devices.  
 For 626 & 630 finishes the escutcheon is plated to simulate stainless steel.  
 Optional door thickness available up to 4-1/2", specify on order.

### 630F series wide pull/thumbpiece trim

- Certified ANSI/BHMA A156.3, Grade 1.
- Trim through-bolts to exit device for strength.
- Beveled sides improve attack resistance.
- Solid forged escutcheon resists vandalism and abuse.
- Flush cylinder in 6-pin applications for additional security.
- 1-3/4" (44mm) door standard. For doors through 2-1/4" (57mm) or shim-mounted devices, specify on order.
- Plate Dimensions: 2-3/4" x 15-1/2" x 5/8" (70mm x 394mm x 16mm).
- Pull Dimensions: 6-7/16" (164mm) on centers x 2-1/8" (54mm) projection.
- Cylinders not included. See page 16 for cylinder options.
- Finishes: 605, 606, 612, 613, 626, 630, 689, 691, 693, 695, 722
- Trim ordering example: 630F x 630
- 5-year limited warranty.

Applications	Cylinder	Exit Only Blank Plate	Nightlatch Access by Key	Nightlatch Cylinder by Pull	Classroom Cylinder Controls T-Piece	Storeroom Cylinder Controls T-Piece	Dummy Trim Pull Plate	Passage Active T-Piece
2100(F) 2150(F) 2110(F) 2120(F) 2160(F) 2170(F)	Rim	630F	631F <sup>2</sup>	632F <sup>2</sup>	633F	633F <sup>1</sup>	634F	635F
ANSI		01	03	03	05	06	02	15

<sup>1</sup> 06 achieved with single trim modification at installation.  
<sup>2</sup> Not recommended for use with vertical rod exit devices.  
 For 626 & 630 finishes the escutcheon is plated to simulate stainless steel.  
 Optional door thickness available up to 4-1/2", specify on order.

## exit device trims

### 440F series rose trim

- Certified ANSI/BHMA A156.3, Grade 1.
- 440F rose trim for stock doors (161 Prep).
- Free-Wheeling trim resists vandalism and abuse.
- 1-3/4" (44mm) door standard. For doors through 2-1/4" (57mm) or shim-mounted devices, specify on order.
- AU, PB and MO trim designs. See below.
- Cylinders included, accepts 6-pin cylindrical type cylinders. If 7-pin cylinders are required, reference 540F trim from 7000 series catalog. See page 17 for cylinder options.
- Finishes: 605, 606, 612, 613, 625, 626, 693, 722

- "B" trim prefix - Lever trim accepting all small format interchangeable cores. 6- or 7-pin. (Example: B-AU446F)
- "M" trim prefix - Lever trim accepting Medeco® (32 series) and ASSA® large format interchangeable cores. Available in AU lever only. 6-pin only. (Example: M-AU446F)
- "S" trim prefix - Lever trim accepting Schlage® standard cylinders. 6-pin only. (Example: S-AU446F)
- "SI" trim prefix - Lever trim accepting Schlage® large format interchangeable cores. Available in AU and PB levers only. 6-pin only. (Example: SI-AU446F)
- 2-year limited warranty.

	 AU	 MO	 PB		
	<b>Applications</b> 2100(F), 2150(F), 2110(F), 2120(F), 2160(F), 2170(F) ANSI	<b>Nightlatch Access by Key</b> 441F 03	<b>Classroom Cylinder Controls Lever</b> 446F 08	<b>Dummy Trim Free Wheeling Lever</b> 448F 02	<b>Passage Lever</b> 448F 14

### 580F series rose trim with escutcheon plate

- 580F rose trim with escutcheon plate for stock doors (161 Prep).
- Free-Wheeling trim resists vandalism and abuse.
- 1-3/4" (44mm) door standard. For doors thru 2-1/4" (57mm) or shim-mounted devices, specify on order.
- AU, PB and MO trim designs. See below.
- Plate Dimensions: 4" (102mm) x 8" (204mm) x 1/8" (3mm)
- Cylinders included, accepts cylindrical type cylinders. See page 17.
- Finishes - lever and rose only: 605, 606, 612, 613, 626, 689, 722.
- Finishes - escutcheon only: 689.

- "B" trim prefix - Lever trim accepting all small format interchangeable cores. 6- or 7-pin (Example: B-AU586F)
- "M" trim prefix - Lever trim accepting Medeco® (32 series) and ASSA® large format interchangeable cores. Available in AU lever only. 6-pin only. (Example: M-AU586F)
- "S" trim prefix - Lever trim accepting Schlage® standard cylinders. 6-pin only. (Example: S-AU586F)
- "SI" trim prefix - Lever trim accepting Schlage® large format interchangeable cores. 6-pin only. (Example: SI-AU586F)
- 3-year limited warranty.

	 AU	 MO	 PB		
	<b>Applications</b> 2100(F), 2150(F), 2110(F), 2120(F), 2160(F), 2170(F) ANSI	<b>Nightlatch Access by Key</b> 581F 03	<b>Classroom Cylinder Controls Lever</b> 586F 08	<b>Dummy Trim Free Wheeling Lever</b> 588F 02	<b>Passage Lever</b> 588F 14



## exit device trims

### 210F series trim

- 1-3/4" (44mm) door standard. For doors through 2-1/4" (54mm) or shim-mounted devices, specify on order.
- Cylinders not included. For rim cylinder options, see page 16.
- Plate Dimensions: 3-1/2" x 3-3/4" x 3/32" (89mm x 95mm x 3mm)
- Finger Pull Dimensions: 3-1/2" x 6-3/4" x 1/8" (89mm x 171mm x 3mm)
- Finishes: 689, 691, 695

				
Application	Cylinder	Nightlatch Access by Key	Dummy Trim Pull Plate	Nightlatch Cylinder by Pull
2100(F), 2150(F)	Rim	213F	214F	217F
ANSI		03	02	03

**Not recommended for surface or concealed vertical rod devices.**

### 121NL cylinder only

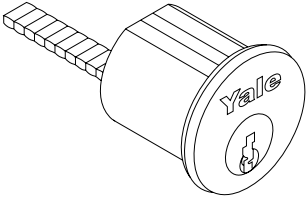
	
Function Description	Nightlatch Access by Key
Model No.	121NL
ANSI	03

- Application: 2100(F) and 2150(F) rim and SquareBolt® exit devices. Not recommended for surface or concealed vertical rod devices.
- Must specify rim cylinder when ordering. See page 16 for cylinder options.
- Cylinder collar 1765.250 furnished standard for 1-3/4" thick doors.
- For 1109, 5109, K300, K640, A640 and 2109 cylinders:
  - Screw part number 34-2311-8738-048
  - Backplate part number 34-0010-1015-059
- For 1193, 5193 and K840 cylinders:
  - Screw part number 10-1193-1018-048
  - Backplate part number 34-0010-1015-059

## cylinders

### rim

The following chart details rim cylinders for use with 620F, 630F, 210F, 121NL trims and outside of SDA16 door alarm:

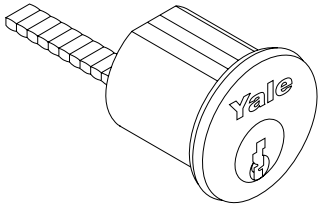
				Collar Requirements*					
				620F	630F	210F	121NL	SDA16 Outside	
Model #	Description	Pins	Length						
1109	Standard Fixed Core	6	1-1/4"	No Collar	No Collar	1765.250	1765.250	1765.250	
1109	Standard Fixed Core	7	1-7/16"	KP4	KP4				
1709	CMK	6	1-15/16"	1765.250	1765.250	1765.500			
1709	CMK	7	1-5/8"		1765.406				
1193	LFIC Complete	6	1-7/16"		1765.250	1765.469			
1193	LFIC Complete	7	1-5/8"	1765.344	1765.406	1765.656			
5109	Security Fixed Core	6	1-9/16"	No Collar	1765.250	1765.250			
5109	Security Fixed Core	7	1-7/16"		No Collar	No Collar			No Collar
U5109	High Security Fixed Core	6	1"			No Collar			No Collar
U5109	High Security Fixed Core	7	1"						
5193	Security LFIC Complete	6	1-7/16"	1765.250	1765.250	1765.469	1765.250	1765.250	
5193	Security LFIC Complete	7	1-5/8"	1765.344	1765.406	1765.656			
K300	Yale® KeyMark® Standard Fixed Core	6	1-1/8"	KP4	1765.250	1765.406			
K300	Yale KeyMark Standard Fixed Core	7							
K840/ K880	Yale KeyMark LFIC Complete / Housing Only	6	1-7/16"	1765.406	1765.500	1765.719			
K840/ K880	Yale KeyMark LFIC Complete / Housing Only	7	1-5/8"	1765.563	1765.719	1765.937			
K640/ K680	Yale KeyMark SFIC Complete / Housing Only	6	1-1/4"	KP4	1765.250	1765.406			
K640/ K680	Yale KeyMark SFIC Complete / Housing Only	6 or 7	1-3/8"	1765.187	1765.406	1765.563			
A640/ K680	Best® Keyway SFIC Complete / Housing Only	6	1-1/4"	KP4	1765.250	1765.406			
A640/ K680	Best® Keyway SFIC Complete / Housing Only	6 or 7	1-3/8"	1765.187	1765.406	1765.563			
2109	Schlage® "C" Keyway Fixed Core Available 0-bitted or keyed random.	6	1-1/8"	No Collar	No Collar	1765.250			

\*Based on 1-3/4" door thickness. Collar length required must be specified for cylinders and/or housings ordered separately.

LFIC = Large Format Interchangeable Core

SFIC = Small Format Interchangeable Core





## cylinders

### component

The following chart details component cylinders for use with 440F and 580F series trim.

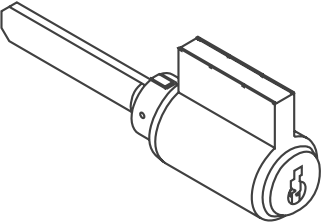
	Model #	Description	Pins
	1802	Standard Lever Fixed Core	6
	1802A*	Standard Lever Fixed Core	7
	5802	Security Lever Fixed Core	6
	5802A*	Security Lever Fixed Core	7
	1210	LFIC Only	6
	1220*	LFIC Only	7
	5210	Security LFIC Only	6
	5220*	Security LFIC Only	7
	K402*	Yale® KeyMark® Lever Fixed Core	6 or 7
	K800*	Yale KeyMark LFIC Only	6 or 7
	K600	Yale KeyMark SFIC Only	6 or 7
	A600	Best® Keyway SFIC Only	6 or 7
	2802	Schlage® "C" Keyway Fixed Core. Available 0-bitted or keyed random.	6
	3804 <sup>1</sup>	Corbin Russwin "L4", Corbin "60", Russwin "D1", Sargent® "LA" or Schlage® "E" Keyway Fixed Core. Specify keyway. Available keyed random	6

\*7-pin not available for 440F series trim. If 7-pin required, refer to 540F series located in 7000 series exit device catalog.



<sup>1</sup>440 series trim requires the 108S kit. These cylinders are not ANSI/BHMA certified.

### mortise

Please see page 18 for the detailed charts of mortise cylinders.

### cylinder collars

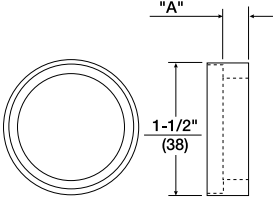
If required, cylinder collar size must be specified.

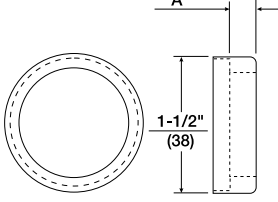
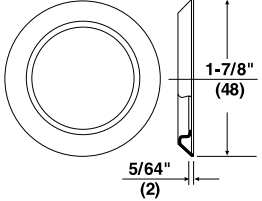
			
<p><b>1765 Recessed Cylinder Collar</b>  <b>"A" Dimension:</b> Thicknesses from 1/16" (2mm) to 1-15/32" (37mm) as required.  <b>Material:</b> Brass, Bronze</p>	<p><b>KP3 Wave Washer</b>                      (Furnished standard with 1765 collar for Yale® KeyMark® cylinders and 630F series trim).</p>	<p><b>599 Recessed Cylinder Collar with Radius "A" Dimension:</b>                      Thicknesses from 1/16" (2mm) to 1-15/32" (37mm) as required.  <b>Material:</b> Brass, Bronze</p>	<p><b>KP4 Flush Mount Cylinder Collar</b>  <b>Material:</b> Brass, Bronze</p>



## cylinders

### mortise

The following chart details mortise cylinders for use with cylinder dogging, 2116 alarms, inside of SDA16 and KRM200 mullions:

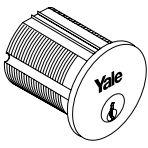
				Cylinder Dogging		2116 Alarm*		SDA16 Inside		KRM200						
				Cam	Collar	Cam	Collar	Cam	Collar	Cam	Collar					
Model #	Description	Pins	Length	Cam	Collar	Cam	Collar	Cam	Collar	Cam	Collar					
2153	Standard Fixed Core	6	1-1/8"	1161E	599.544	2160	No Collar	2160	No Collar	2160	1765.312					
2153	Standard Fixed Core	7	1-1/4"		599.700						1765.500					
2196	LFIC Complete	6	1-1/2"		599.925		1765.250		KP4		1765.750					
2197	LFIC Complete	7	1-11/16"		599.1.04		1765.500		1765.250		1765.844					
5153	Security Fixed Core	6	1-1/8"		599.544		No Collar		2160		No Collar	2160	1765.312			
5153	Security Fixed Core	7	1-1/4"		599.700								1765.500			
U5153	High Security Fixed Core	6	1-1/8"		Special		NA		KC1		No Collar	KC1	KC1	NA		
U5153	High Security Fixed Core	7	1-1/4"				NA							NA	NA	NA
5196	Security LFIC Complete	6	1-1/2"				599.925							1765.250	KP4	1765.750
5197	Security LFIC Complete	7	1-11/16"				599.1.04							1765.500	1765.250	1765.844
K100	Yale® KeyMark® Standard Fixed Core	6 or 7	1-1/8"	599.544		KC1	No Collar	KC1		KC1				1765.312		
K820/ K860	Yale KeyMark LFIC Complete / Housing Only	6	1-1/2"	599.925										1765.250	KP4	1765.750
K820/ K860	Yale KeyMark LFIC Complete / Housing Only	7	1-11/16"	599.1.04	1765.500				1765.250		1765.000					
K620/ K660	Yale KeyMark SFIC Complete / Housing Only	6	1-1/4"	599.700	No Collar				2160		2160	2160	1765.500			
K620/ K660	Yale KeyMark SFIC Complete / Housing Only	6 or 7	1-3/8"	599.850									1765.250	1765.563		
A620/ K660	Best® Keyway SFIC Complete / Housing Only	6	1-1/4"	599.700									No Collar	2160	2160	1765.500
A620/ K660	Best® Keyway SFIC Complete / Housing Only	6 or 7	1-3/8"	599.850												1765.563
2553	Schlage® "C" Keyway Fixed Core. Available 0-bitted or keyed random.	6	1-1/8"	1161E	599.544				2160		2160	2160	1765.312			

Based on 1-3/4" door thickness. Collar length required must be specified for cylinders and/or housings ordered separately.

LFIC = Large Format Interchangeable Core. SFIC = Small Format Interchangeable Core

NA = Application Not Available

\*2116 door alarm kit discontinued September 1, 2012.

### cams

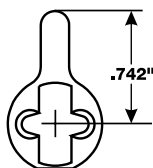

2160

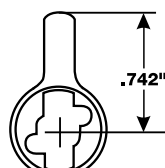

KC1

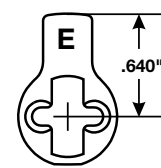

1161E

## strikes

### rim devices

<p><b>757F</b> Standard strike for 2100(F) and 2150(F) devices. Supplied with #10-24 x 3/4" machine screws, two shims (each 1/16" thick), and one locking plate.</p>	<p><b>257FWS</b> Standard strike for 2100(F)WS devices. Supplied with 2 each #10-24 x 1-1/4" and 2 each #10-24 x 3/4" machine screws.</p>	<p><b>757FWS</b> Standard strike for 2150(F)WS. Supplied with 2 each #10-24 x 1-1/4" and 2 each #10-24 x 3/4" machine screws, two shims (each 1/16" thick), one locking plate and one interlocking bracket (not shown) with 4 each #10-24 x 3/4" machine screws.</p>	<p><b>793</b> Optional strike for double door applications without a mullion. Supplied with #10-24 x 3/4" machine screws, two shims (each 1/16" thick), and one locking plate. Panic only.</p>

### vertical rod devices - top strikes

<p><b>791</b> Standard top strike for 2110(F) and 2120(F) series devices. Supplied with #10-24 x 3/4" machine screws, two shims (each 1/16" thick), and one locking plate.</p>	<p><b>726</b> Standard top strike for 2170(F) series devices. Supplied with #12-24 x 11/16" machine screws and #12 x 1-1/4" sheet metal screws, and one shim (1/16" thick).</p>	<p><b>761</b> Standard top strike for 2160(F) series devices. Supplied with #10-32 x 3/8" machine screws and #10 x 1" sheet metal screws.</p>	<p><b>797</b> Optional bracket for mounting 791 top strike in flush transom opening. Supplied with 1/4-20 machine screws; SN-134 sex nuts, optional.</p>

### vertical rod devices - bottom strikes

<p><b>790</b> Standard bottom strike for 2110(F), 2120(F), 2160(F) and 2170(F) series devices. Press in place.</p>	<p><b>794</b> Optional bottom strike for fire openings using saddle thresholds or for flush floor mount. Must use for fire openings with 1/2" thresholds. Supplied with #10-24 x 1/2" machine screws and floor anchors.</p>	<p><b>702</b> Optional bottom strike for bottom pullman latch option. Supplied with #8 x 8/32" combination screws.</p>



## accessories/options

### shim kits

Shim kits are available for devices on doors with interfering molding. Each shim kit contains:

- 2 sets of 1/8" shims (shim up to 1/4")
- Longer fasteners
- Longer tailpiece for the trim
- Installation instructions
- 693 (Black) finish

**223** - Shim kit for 2100(F) rim, 2150(F) SquareBolt® and 2120(F) and 2160(F) series\* concealed vertical rod exit devices

**224** - Shim kit for 2110(F) and 2170(F) series surface vertical rod exit devices.

**\*Special concealed vertical rod components needed for openings requiring more than (2) shim kits. Details on application.**

### cylinder dogging

Cylinder dogging is available as an option on panic-rated devices only. It requires the use of a mortise cylinder. To order, the fourth digit of the device model number is changed from a "0" to a "5". Cylinder type must be specified, not available less cylinder. See page 18 for cylinder, cam and collar requirements. A retrofit dogging kit to convert hex key dogging to cylinder dogging is not available for the 2100 series exit devcies.



### extension rods

2110 surface vertical rod devices are supplied standard for 7' (2.13m) standard. Rods may be field cut or used with extension rods for other heights. To order, specify:

Model Number	Length
2010-2	2" (51mm)
2010-6	6" (153mm)
2010-12	12" (305mm)
2010-24*	24" (610mm)

**\*Used for 10' door applications with 2170(F90)**

### bottom pullman latch

Optional bottom Pullman latch available for panic-listed vertical rod exit devices. To order with devices, specify "BPL." 702 bottom strike required, see page 19.

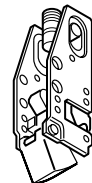

### specialty fasteners

#### Sex Nuts:

Required for wood, composite or unreinforced metal doors. To order specify:

- **SN-104** – pack of (4) 10-24 sex nuts for all fire rim exits
- **SN-134** – pack of (4) 1/4-20 sex nuts for all devices

#### Wood Door Fasteners:

For solid core wood doors, permitted if pilot holes are used to install screws. Consult the factory for availability.

Torx® Security Screws available for factory product orders.

## accessories/options

### long tailpiece kit

Long tailpiece kit for use with escutcheon series trim, up to 4-1/2" thick doors. Specify part number to order.

Door Thickness	Trim Type	Part Number
2" - 2-1/2"	620F and 630F Series Trim	81-9500-1665-000
2-1/2" - 3-1/2"	620F and 630F Series Trim	81-9500-1635-000
3-1/2" - 4-1/2"	620F and 630F Series Trim	81-9500-1636-000

### wide style cover

2100 series devices are available with an optional wide style cover. To order with device, specify option: "WIDE".

To order cover separately, specify part number:

60-2000-1241 x Finish = for use with 2100(F)

60-2150-1244 x Finish = for use with 2150(F)

60-2110-1243 x Finish = for use with 2110(F) & 2170(F)

60-2000-1240 x Finish = for use with 2120(F) & 2160(F)



### plastic installation template

Provided as a standard with all 2100 series exit device, the plastic installation template facilitates door markings over traditional paper templates. This provides a more accurate door prep which reduces installation mistakes and overall installation time. Template dimensions: 8-1/4" x 3-1/4" (210mm x 83mm). To order separately, specify part number: 60-7000-9100-999.

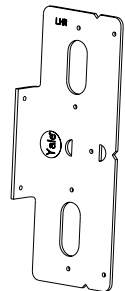

### Schlage® cam assembly

This cam and housing assembly includes a cam engineered to accept Schlage® rim cylinders. No modifications are required to existing 500 and 600 series exit device trims thus maintaining the trim's classroom and storeroom functions. To order, specify part number: 60-7000-0815.



### Von Duprin® tailpiece

This tailpiece is available for the Yale® 1109 rim cylinder to operate the night latch function for Von Duprin® exit devices. To order, specify part number: 34-1145-1005-048



## mullions

### M200(F) removable mullion

M200(F) steel mullions are for use with 2100(F) series exit devices. Mullions may be field cut to fit opening. Red primer finish.

- M200 panic rated.  
Tubular steel, 2" x 3" (51mm x 76mm). Specify 7', 8', or 10'.
- M200F 3 hour fire rated.  
Tubular steel, 2" x 3" (51mm x 76mm). Specify 7' or 8'.

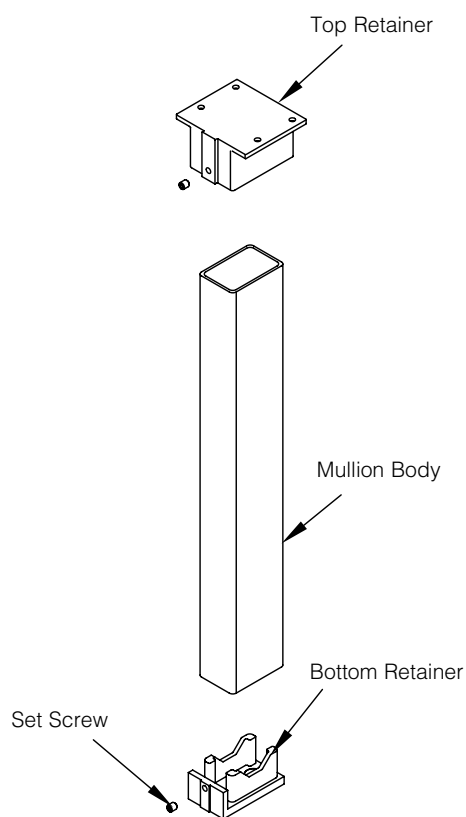

### M200(F) options

- **M203 Spacer Block**  
Recommended for double rabbeted frames where the stop face width is less than the mounting hole spacing or for applications with 5-3/4" (146mm) or less door frames.

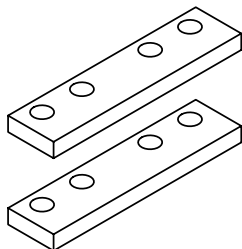

- **M204 Angle Bracket**  
Recommended for any header configuration with less than 3" (76mm) of mounting surface.

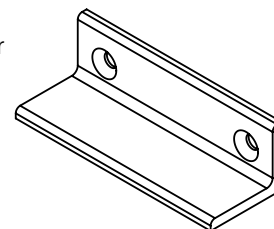

## mullions

### KRM200(F) keyed removable mullion (KRM)

Keyed removable mullions are for use with 2100(F) series exit devices. They are designed for simple removing when an unobstructed large opening is required and easy replacement and locking to maintain the integrity of the opening.

- KRM200 panic rated. Specify 7', 8', or 10'.
- KRM200F 1-1/2 hour fire rated. Specify 7' or 8'.

### krm features

- Easy cylinder installation.
- Mullion automatically relocks when reinstalled without the use of the cylinder key.
- When ordering, add KR prefix to mullion, example: KRM200 and KRM200F.

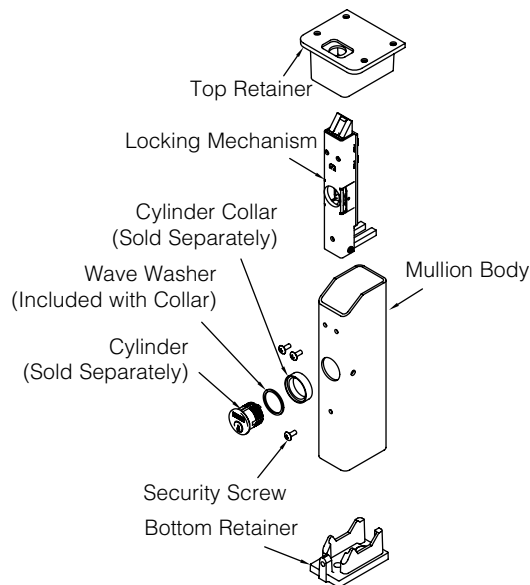

### krm options

- **M203 Spacer Block**

Recommended for double rabbeted frames where the stop face width is less than the mounting hole spacing or for applications with 5-3/4" (146mm) or less door frames.

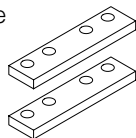

- **M204 Angle Bracket**

Recommended for any header configuration with less than 3" (76mm) of mounting surface.

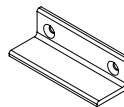

### krm cylinders

As with any exit device trim, you must order a cylinder and collar if one is required. The Yale® keyed removable mullion accepts a mortise cylinder. Refer to page 18 for details.



## stand-alone door alarm

The SDA16 stand-alone battery operated door alarm is designed to continually monitor the status of a door. When the door is opened without authorization, an alarm is triggered to alert the security violation. This alarm features a Peizo horn which blasts a deafening 105+ decibels to alert the violation.

This unit is ideal for emergency doors as well as stairwell doors and rear exit doors in retail environments. The unit, which can also be hardwired, easily complements existing hardware, making any opening alarmed. The SDA16 door alarm is typically mounted on the interior of the door frame or door and is paired with a magnet mounted on the opposing side of the door gap.



### features

- Dimensions: 8.3"L x 3.1"W x 2.0"D (210mm L x 79mm W x 52mm D)
- Non-handed unit (field reversible)
- Unit powered by 9V battery
- Unit can be hardwired by using WH-11 wire harness and 784 power supply
- No battery is required in unit with hard-wire option – if power is lost, optional gel-cell battery in power supply will give approximately 10,000 operations
- Reverse battery protection safeguards the unit if the battery is incorrectly installed
- A low-voltage battery is indicated by an audible signal every 30 seconds
- Piezo horn blasts at 105+ decibels if the door is used with out proper authorization
- The LED will flash every 30 seconds, indicating either the unit is armed or, if under auto reset, that the door has been violated
- Various field-adjustable features by dip switch including automatic alarm reset, REX and passage time delay, and LED color preference
- A tamper switch provides instantaneous signal to sound horn in the event the cover is removed. Horn will sound until the unit is reset by the key or remote reset/arm switch
- Conformally coated electronics for weather resistance
- Cover is held in place by cam lock which protects mounting screws, electrical system and internal sensors
- Accepts external cylinder (not included, must be specified)
- Accepts standard mortise cylinders (not included, must be specified)

### remote mounting

The SDA16 can be installed remotely from the door by attaching the contacts to the door and frame. The unit can be installed up to 6 feet from the door. This provides the ideal solution for circumstances where exposure to weather may be an issue. To order specify "SDA16XL".

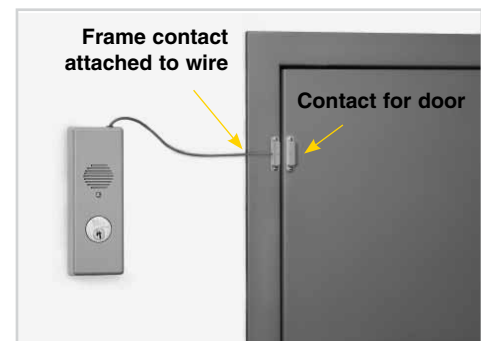

**Note: Actual wire length is 6 feet.**

### cylinders and accessories

- 784 Power supply (9VDC) — includes plug-in wall transformer
- Plug-in wall transformer with 12' cable assembly (part no. 00-0000-3425)
- Gel-cell battery — optional for use with 784 power supply (part no. 00-0000-3426)
- WH-11 Wire harness for remote power and remote unlock
- Mortise cylinder for unit
- Rim cylinder for outside control
- See pages 16 & 18 for cylinder information.



facts and figures

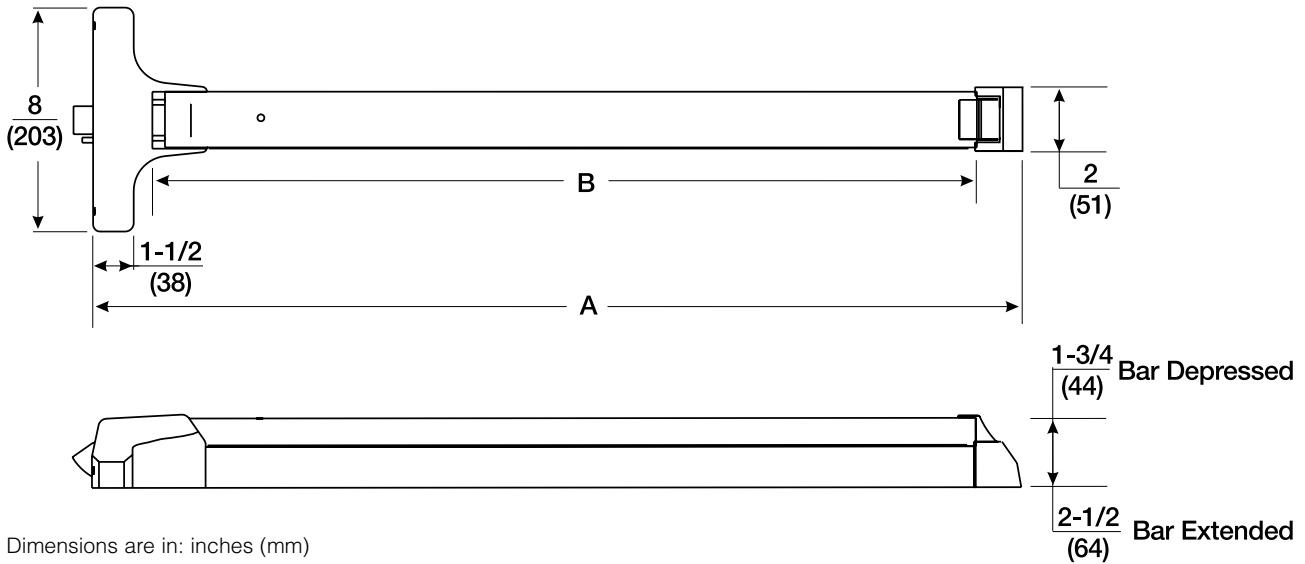

Dimensions are in: inches (mm)

Device Size	"A"	"B"
36"	32-3/8" (82cm)	27" (69cm)
42"	38-3/8" (98cm)	33" (84cm)
48"	44-3/8" (113cm)	39" (99cm)

trim dimensions

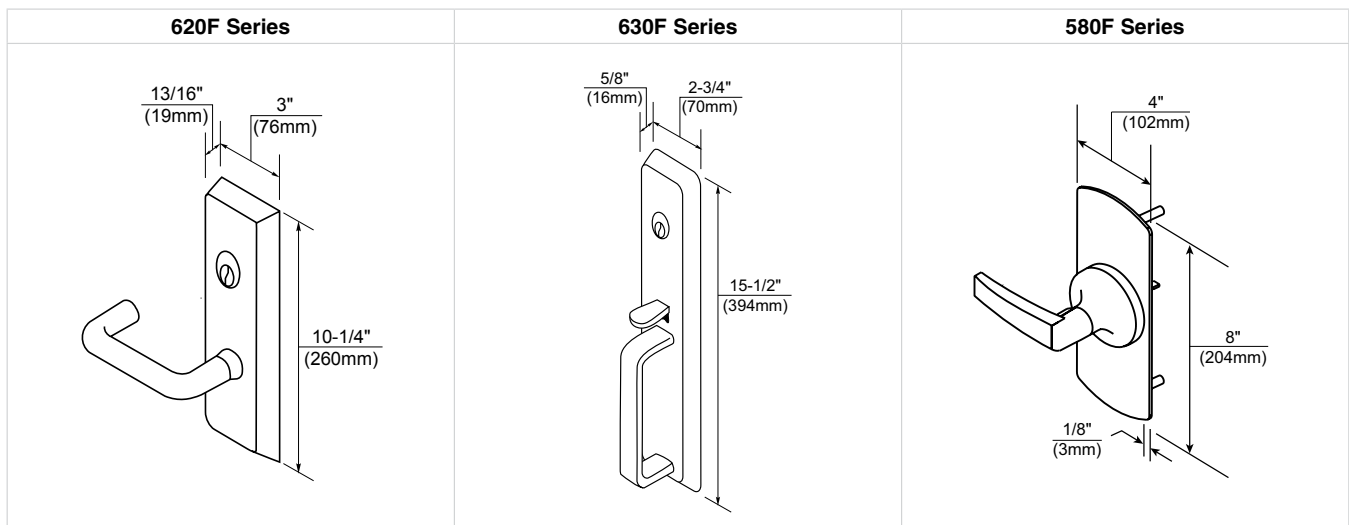

## ordering information

2	1	X	0	Suffix	-XX	Outside Trim	Finish	Other Info
		<b>Third Digit:</b> "0" - Rim Device, Pullman Latch  "1" - SVR Device  "2" - CVR Device  "5" - SquareBolt® Rim Security  "6" - CVR Device  "7" - SVR Device	<b>Fourth Digit:</b> "0" - Standard  "5" - Cylinder Dogging (Not with suffix "F")	<b>No Suffix -</b> Panic label  "F" - Fire exit device  "WS" - Windstorm Certified Products (see notes 4, 5, 6)	<b>Size: (DOW=Door Opening Width)</b>  "36" - 30" - 36" (0.76m to 0.91m) DOW  "42" - 36" to 42" (0.91m to 1.07m) DOW  "48" - 42" to 48" (1.07m to 1.22m) DOW	<b>Trim Model Number</b>  See pages 12-15	605 606 612 613 630 689 691 693 695 722	<b>Door Hand</b> - RHR or LHR (vertical rod devices or lever escutcheon trim only). Rim devices are field reversible.  <b>SN-134, 1/4-20 Sex Nuts (pack of 4).</b>  <b>SN-104, 10-24 Sex Nuts (pack of 4).</b>  <b>Door thickness: over 1-3/4" (45mm).</b>  <b>Rod Extensions:</b> (quantity) 2010-2 (quantity) 2010-6 (quantity) 2010-12 (quantity) 2010-24  <b>Shim Kits:</b> (quantity) 223 (quantity) 224  <b>Optional Strike</b> <b>Bottom Pullman Latch</b> <b>Removable Mullion:</b> M200, Panic Exit M200F, Fire Exit KRM200, Panic Exit KRM200F, Fire Exit  <b>Custom Cylinder &amp; Cylinder Collar</b> <b>Factory Keying</b>

**Notes:**

1. It is recommended that exit devices and trim for the same opening be ordered together.
2. Standard product is for 1-3/4" (44mm) reinforced metal doors.
3. Accessories detached from the device and trim should be specified separately.
4. "WS" applies only to 2100(F) devices.
5. Maximum opening size 3'0" x 7'0".
6. Contact Ceco, Curries® or Fleming for detailed frame/door requirements and limitations.

## sample specification

---

Exit devices shall be 2100 Series Pushpad Exit Devices as manufactured by Yale Locks & Hardware.

The exit device chassis and push pad assembly shall be of high-grade non-ferrous steel material, electroplated for protection against rust, and shall have a baked powder coating. The maximum projection shall be 2-1/2" when the push pad is active and 1-3/4" when the push pad is dogged down. Nylon bearings and stainless steel springs shall be used for long life and durability; only torsion springs are acceptable. Rear and active case covers shall be steel and shall have a baked powder coating to match the exit bar. Plastic covers are not acceptable. Latchbolts shall be steel and shall incorporate a deadlocking latch for increased security. Devices without deadlocking latches are not acceptable. Mounting screws shall be concealed to deter tampering. Devices shall be closed on all sides with no pinch points. Exit devices shall be easily field sized to accommodate various door widths.

Panic-listed exit devices shall have single point, one quarter turn hex key dogging standard. Optional cylinder dogging shall be available on panic listed devices. Panic-listed devices shall be available less dogging.

Trims shall be through-bolted with concealed fasteners. Escutcheon and pull-type trims shall be constructed of brass, bronze or zinc. All lever trims shall use cast or forged levers. On rim and vertical rod trims with cylinders, the mechanism that locks and unlocks the trim shall be housed in the trim and not in the active case of the exit device. Lever trims shall be Free Wheeling with clutch mechanism allowing lever to rotate 60° when locked to prevent vandalism. Lever trims shall match those on Yale® mortise and cylindrical locksets.

Exit devices and trims shall be furnished in ANSI/BHMA standard architectural finishes. Exit devices shall be listed by Underwriters Laboratories (UL, cUL) for safety as panic hardware. Fire-rated devices shall be listed for "A" label and lesser class doors. Devices shall also be UL listed for ZHEM - latching hardware and ZHLA - windstorm rated assemblies.

**Certification:**

ANSI/BHMA A156.3, Grade 1

Devices, trims and cylinders shall be from one manufacturer. Devices shall carry a three-year warranty and escutcheon trims shall carry a five-year warranty.

## online literature and templates

---

For the latest information on Yale Locks & Hardware products, visit our website at: [www.yalelocks.com](http://www.yalelocks.com)

Click on the "Product Information" button to find:

- Catalogs
- Parts manuals
- Templates
- Specifications
- Installation instructions

Yale® customers can click on the ebusiness symbol  on the website to register for an ebusiness account to:

- Check the status of orders
  - Check availability of QuickShip items
  - Track your order and confirm delivery
  - Receive email notification of template changes
- And More...

Or contact us at:

### U.S.A.

#### Yale Locks & Hardware

Address: 225 Episcopal Road, Berlin, CT 06037-4004  
 Tel: 1-800-438-1951 • Fax: 1-800-338-0965 • [www.yalelocks.com](http://www.yalelocks.com)

### Canada:

#### ASSA ABLOY Door Security Solutions Canada

Address: 160 Four Valley Drive, Vaughan, Ontario L4K 4T9  
 Tel: 1-800-461-3007 • Fax: 1-800-461-8989 • [www.assaabloy.ca](http://www.assaabloy.ca)

### International:

#### ASSA ABLOY Americas International

Tel: 1-905-821-7775 • Fax: 1-905-821-1429 • [www.assaabloyai.com](http://www.assaabloyai.com)

Yale Locks & Hardware is a division of Yale Security Inc., an ASSA ABLOY Group company.

Yale®, SquareBolt®, Reflections® and MicroShield® are registered trademarks of Yale Security Inc., an ASSA ABLOY Group company. KeyMark® and KeyMark and Design® are registered trademarks of Medeco Security Locks, Inc., an ASSA ABLOY Group company. Other products' brand names may be trademarks or registered trademarks of their respective owners and are mentioned for reference purposes only. These materials are protected under U.S. copyright laws. All contents current at time of publication. Yale Security Inc. reserves the right to change availability of any item in this catalog, its design, construction, and/or its materials. Copyright © 2002, 2012, Yale Security Inc., an ASSA ABLOY Group company. All rights reserved. Reproduction in whole or in part without the express written permission of the Yale Security Inc., an ASSA ABLOY Group company, is prohibited.

**YALE**, with its unique global reach and range of products, is the world's favorite lock.

**ASSA ABLOY** is the global leader in door opening solutions, dedicated to satisfying end-user needs for security, safety and convenience.

42135-9/12R