

Harmony™ Wireless & Batteryless Push Button Quick Start Guide



Make the most of your energy™

Schneider
Electric™

Understanding the Receiver Symbols

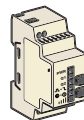
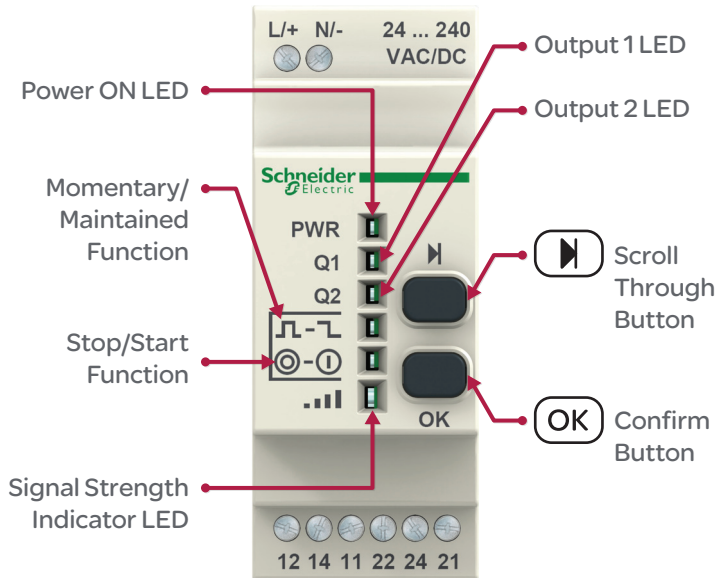



Receiver





Transmitter

Programming Transmitter to Receiver







1. Press the  button on the receiver until the Q1 LED is blinking then release and press the  button.*
2. Press the transmitter button 3 times.
3. Once the yellow Q1 LED turns off, the programming is a success!

* To program on a different output (e.g., Q2): Press and hold the  button on the receiver until the Q1 LED is blinking, release and press the  button again until LED for desired output is flashing and press the  button. Continue to Step 2 above.

Deprogramming Transmitter from Receiver











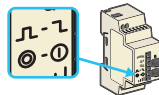

1. Press the  button on the receiver until the Q1 LED is blinking then release and press the  button.*
2. Press the transmitter button 6 times.
3. Once the yellow Q1 LED turns off, the deprogramming is a success!

* To deprogram on a different output (e.g., Q2): Press and hold the  button on the receiver until the Q1 LED is blinking, release and press the  button again until LED for desired output is flashing and press the  button. Continue to Step 2 above.

Changing Relay Functions*

Momentary, Maintained, Stop/Start



1. Press both  and  buttons at the same time until Q1 LED and Momentary/Maintained LED are blinking then release.
2. Press the  button for desired output, then press the  button. The Output LED will be solid, and only the Momentary/Maintained or Stop/Start LED will be flashing.
3. Press the  button for desired relay function:
 -  2 flashes = Momentary / 4 flashes = Maintained
 -  = Stop/Start
Then press the  button.
4. Proceed to Programming Transmitter to Receiver.

* Only available on ZBRRA receiver.

Distance Between Transmitter & Receiver

Good signal strength *

The last signal sent from the transmitter was good.



Weak signal *

The last signal sent from the transmitter was weak. Shorten distance or remove obstacles between transmitter and receiver, and try again.



No signal **

The last signal sent from the transmitter was not received. Shorten distance or remove obstacles between transmitter and receiver, and try again.



* After 1 minute, the LED will turn off.

** Or it has been longer than 1.5 minutes since last signal was received.

Note: The wireless signal strength is determined only from the last signal sent from the transmitter. *It is not continuously monitoring the wireless signal strength between the transmitter and receiver.*

More Information

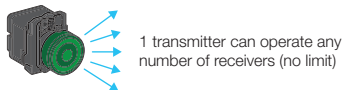
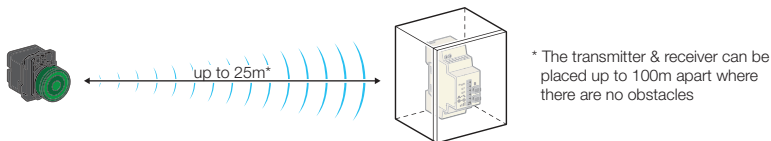

Additional Programming Instructions

Scan the barcode with your camera phone or follow the link below



Scan to view additional programming instructions
#EIO0000000812



Scan to view the programming video online

<http://www.schneider-electric.us/go/wireless>

www.schneider-electric.us

Schneider Electric™ and Harmony™ are trademarks or registered trademarks of Schneider Electric and/or its affiliates in the United States and/or other countries.

The information and dimensions in this guide are provided for the convenience of our customers. While this information is believed to be accurate, Schneider Electric reserves the right to make updates and changes without prior notification and assumes no liability for any errors or omissions.

Schneider Electric USA, Inc.

8001 Knightdale Blvd.
Knightdale, NC 27545
1-888-SquareD
1-888-778-2733