

Horn/Strobe/Speaker Damage Stoppers®

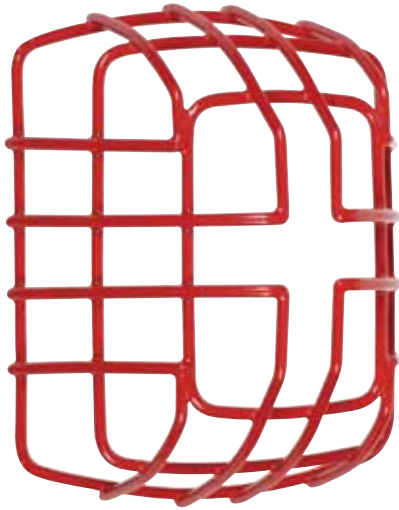

STI-9705-R

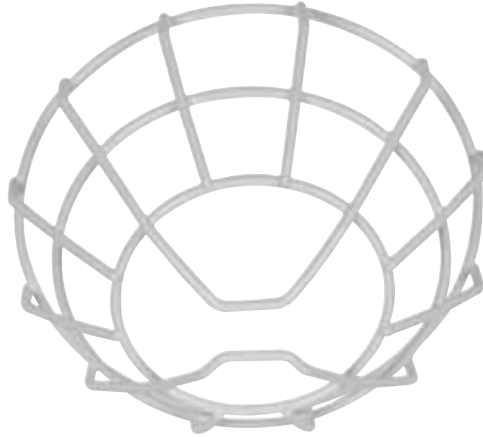

STI-9711



STI-9720

PRODUCT OVERVIEW

Here are excellent ways to protect strobe units against both vandalism and accidental damage. Constructed of tough, 9-gauge steel wire coated with corrosion resistant red or white polyester, these guards can take hard knocks in stride. STI-9705, STI-9708, STI-9711 and STI-9714 wire guards provide maximum protection for System Sensor SpectrAlert® Advance series strobe notification appliances.

BACKED BY A THREE YEAR GUARANTEE

As all STI protective covers, these guards are backed by a three year guarantee against breakage in normal use. Installation and servicing is easy with all screws and anchors provided. This Stopper is highly recommended for areas where abuse is severe or it is imperative that strobe units continue to operate. STI-9717 and STI-9720 fit over System Sensor notification appliances SP2R1224MC and SP2W1224MC.

FEATURES

- Offers protection against vandalism and accidental damage.
- Constructed of tough 9-gauge steel wire.
- Installation is fast and simple with screws and anchors provided.
- Simple removal for maintenance.
- Coated with corrosion resistant polyester.
- STI-9705, STI-9708, STI-9711 and STI-9714 protect SpectrAlert® strobe units.
- STI-9717 and STI-9720 fit over System Sensor notification appliances SP2R1224MC and SP2W1224MC.
- Three year guarantee against breakage in normal use.

Horn/Strobe/Speaker Damage Stoppers®

Dimensions and Technical Information

MODELS AVAILABLE

STI-9705	Damage Stopper, Flush Mount - White
STI-9705-R	Damage Stopper, Flush Mount - Red
STI-9708	Damage Stopper, Surface Mount - White
STI-9708-R	Damage Stopper, Surface Mount - Red
STI-9711	Damage Stopper, Flush Mount - White
STI-9714	Damage Stopper, Surface Mount - White
STI-9717	Speaker/Strobe Damage Stopper - Flush Mount (not UL Listed)
STI-9720	Speaker/Strobe Damage Stopper - Surface Mount (not UL Listed)

MODEL	HEIGHT	WIDTH	DEPTH
STI-9705			
STI-9705-R	7.40 in. (188mm)	6.15 in. (156mm)	3.39 in. (84mm)
STI-9708			
STI-9708-R	7.49 in. (190mm)	6.74 in. (171mm)	6.09 in. (155mm)
STI-9711	8.26 in. (210mm)	8.26 in. (210mm)	3.54 in. (90mm)
STI-9714	8.55 in. (271mm)	8.55 in. (271mm)	6.23 in. (158mm)
STI-9717	6.1 in. (155mm)	9.3 in. (238mm)	2.4 in. (61mm)
STI-9720	6.1 in. (155mm)	9.3 in. (238mm)	4.9 in. (125mm)

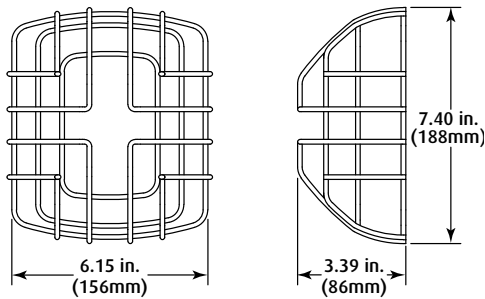

STI-9705

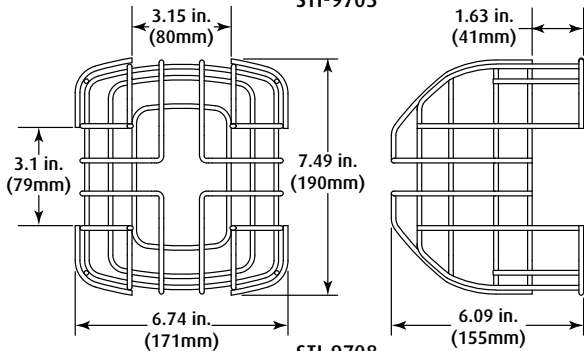

STI-9708

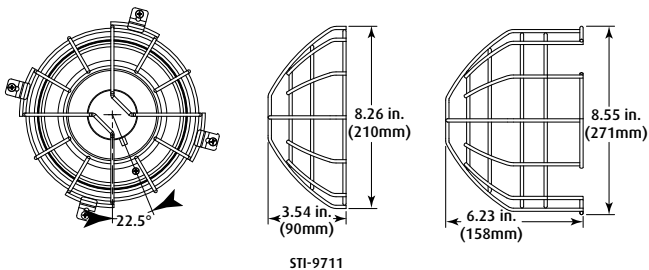

STI-9711

APPROVALS & WARRANTY

TESTING

STI-9705, STI-9708, STI-9711 and STI-9714 have been tested and approved or listed by:

· Underwriter Laboratories and Canadian UL File S7025

WARRANTY

Three year guarantee against breakage in normal use.

Light De-Rating Factor

STI-9705 and STI-9708

System Sensor (SR,SW, SW-ALERT, SW-CLR-ALERT, SRK, SWK, P2R, P2W, P4R, P4W, CHSR, CHSW, P2RK, P2WK, P4RK, P4WK, SPSR, SPSR-SP, SPSR-PG, SPSW, SPSW-CLR-ALERT, SPSW-SP, SPSW-PG, SPSRV, SPSRV-SP, SPSRV-PG, SPSWV, SPSWV-SP and SPSWV-PG, SPSWK, SPSRK, SPSW-ALERT)

Light Loss
%

13%

System Sensor (SRH, SWH, SRHK, SWH-ALERT, SWHK, P2RH, P2WH, P4RH, P2RHK, P2WHK, P2RHK-120, SPSRH, SPSRH-SP, SPSRH-PG, SPSWH, SPSWH-SP and SPSWH-PG, SPSRHK)

0%

STI-9711 and STI-9714

System Sensor (SCR, SCW, SCRK, SCWK, SCW-CLR-ALERT, PC2R, PC2W, PC4R, PC4W, PC2RK, PC2WK, PC4WK, SPSCWV, SPSCR, SPSCR-SP, SPSCR-PG, SPSCW, SPSCW-SP, SPSCW-PG, SPSCRV, SPSCRV-PG, SPSCWV, SPSCWV-SP and SPSCWV-PG, SPSCWK, SPSCW-CLR-ALERT)

0%

System Sensor (SCRH, SCWH, SCRHK, SCWHK, PC2RH, PC2WH, PC4RH, PC2RHK, PC2WHK, PC4WHK, SPSCRH, SPSCRH-SP, SPSCRH-PG, SPSCWH, SPSCWH-SP, SPSCWH-PG, SPSCRVH, SPSCRVH-SP, SPSCRVH-PG, SPSCWHV-SP, SPSCWHV-PG, SPSCWHK)

0%

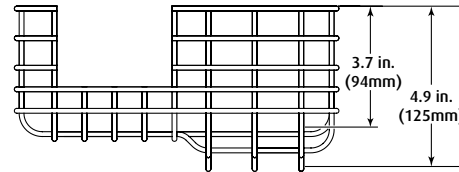

STI-9720
TOP VIEW

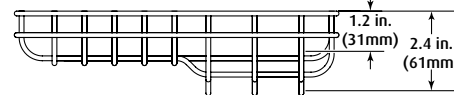

STI-9717
TOP VIEW

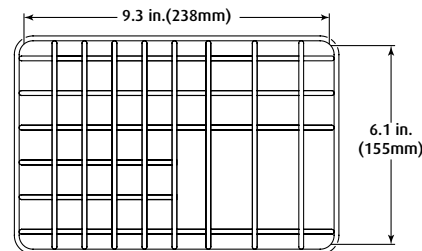

STI-9717 and STI-9720
FRONT VIEW



Safety Technology International, Inc.

2306 Airport Road
Waterford, Michigan
48327, USA

Tel: 248-673-9898
Fax: 248-673-1246
Toll-free: 800-888-4784
info@sti-usa.com
www.sti-usa.com

Unit 49G Pipers Road
Park Farm Industrial Estate
Redditch, Worcestershire
B98 0HU England

Tel: 44 (0) 1527 520 999
Fax: 44 (0) 1527 501 999
Free: 0800 085 1678 (UK)
www.sti-europe.com