

CFG1\*\*

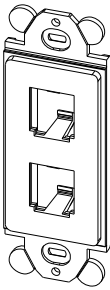

CFG2\*\*

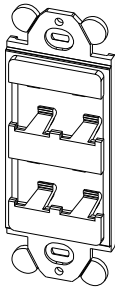

CFG4\*\*

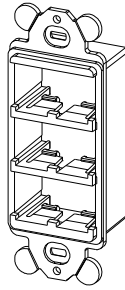

CFG6\*\*

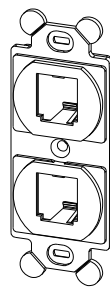

CF1062\*\*Y

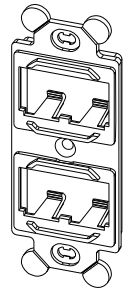

CF1064\*\*Y

## INSTALLATION

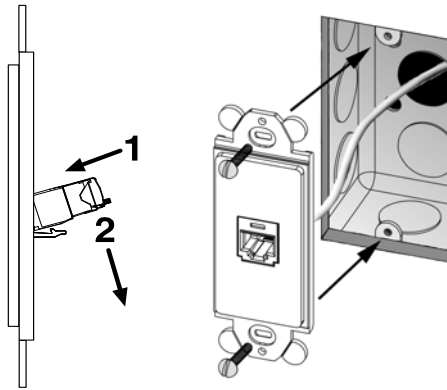

## REMOVAL

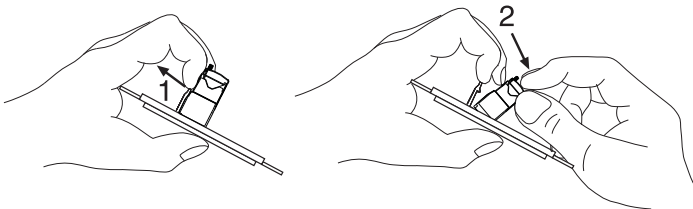

\*\* Denotes color