

T-4002-301, T-4002-303 (DA) and T-4002-302, T-4002-304 (RA) Thermostat with Cover and Two-Pipe Conversion Kits

The T-4002-301 and T-4002-303 Direct Acting (DA) and the T-4002-302 and T-4002-304 Reverse Acting (RA) Thermostat with Cover and Two-Pipe Conversion Kits are designed for converting existing non-Johnson Controls® single temperature room instruments. The T-4002-301 and T-4002-302 Thermostats include a white cover and cover plate, and the T-4002-303 and T-4002-304 Thermostats include a beige cover and cover plate.

Each kit contains the necessary parts and instructions for converting two-pipe existing instruments; all leftover or unused parts should be discarded. See Table 1 for a description of the contents of each kit, and see Table 2 for a listing of all known non-Johnson Controls conversions.

Table 1: Contents of Kit

Qty	Description - Packages and Parts
1	Room Instrument - contains: (1) Room Thermostat (DA) or (RA)
1	Instrument Cover - contains: (1) Cover
1	Faceplates and Dial Label - contains: (1) Faceplate - Blank, (1) Faceplate - Horizontal with Logo, (1) Faceplate - Horizontal, No Thermometer Single Window, (1) Faceplate - Vertical with Logo, (1) Dial Strip - Vertical, Right, and (1) Window
1	Cover Plate/Subplate - contains: (1) Cover Plate with Room Instrument Mounting Bracket attached by (2) No. 6 x 3/8 in. pan head self-tapping screws, (1) Subplate and (2) No. 6-32 x 5/8 in. pan head taptite screws to mount cover plate to subplate.
1	Terminal Connector and Tubing - contains: (1) Terminal Connector (2-tube with angle terminals and O-rings assembled) and (2) 8 in. lengths of 5/32 in. O.D. (black) polyethylene tubing with anti-kink springs attached.
1	Adjustable Pipehead - contains: (1) Adapter Plate, (5) No. 8 flat round washers, and (3) flat round washer gaskets.
1	Tube Couplings and Clamps - contains: (2) 5/32 in. x 5/32 in. tubing couplers, (2) 5/32 in. x 1/4 in. tubing couplers and (2) 5/32 in. tube clamps.
1	Mounting Hardware - contains: (2) No. 4-40 x 1-5/8 in. pan head machine screws, (2) No. 5-40 x 3/4 in. studs, (4) No. 5-40 hex nuts, (2) No. 5-40 x 1-1/4 in. pan head machine screws, (2) No. 6 x 7/8 in. pan head self-tapping screws, (2 ea.) No. 6-32 x 7/16 in., (2 ea.) No. 6-32 x 1-1/4 in., and (2 ea.) No. 6-32 x 2 in. pan head machine screws, (2) No. 6 x 1-3/4 in. pan head self-tapping screws, (2) No. 6 star washers, (1) No. 8 x 1-3/4 in. pan head self-tapping screw, (2) No. 8-32 x 1-3/4 in. pan head machine screws, (2) No. 10-24 x 1-1/2 in. pan head machine screws, and (2) No. 10 star washers.
1	Instruction Sheet Part No. 24-1855-13

**Table 2: Non-Johnson Controls
Conversions**

Existing Installation for Conversion	Page
Barber-Colman "TK" Series or "TKR" Series Wallbox and Mortar Joint	6
Honeywell TO900 or TP900 Series Wallbox	7
Honeywell TO910 or TP910 Series Wallbox and Mortar Joint	7, 8
Honeywell TP970 Series Shallow and Deep Wallboxes	8
Landis & Gyr Powers TH832 "D" Series Wallbox and Ground Plate	8, 9
Landis & Gyr Powers T-21 Series Ground Plate, Wallbox and Mortar Joint	9
Landis & Gyr Powers TH 180 Series Wallbox and Drywall Mounting	10
Landis & Gyr Powers TH-192 Series Wallbox and Drywall Mounting	--
Robertshaw T-15 (Metal) Early Wallbox and Mortar Joint	10, 11
Robertshaw T-15 Later Wallbox and Mortar Joint	10, 11
Robertshaw 2212 Series	--
Robertshaw T-18 (Plastic) Drywall Mounting	11
Draeger (ITT/Essen/Johnson Controls) Wallbox	11
UPC	11

Subplate and Cover Plate with Instrument Mounting Bracket

The subplate furnished with this kit is designed with specific pairs of slots and holes for attaching it to the existing installation wall, wallbox or mortar joint. Holes are also provided for attaching the plastic cover plate and guard kit (if required).

The plastic cover plate is furnished with the room instrument mounting bracket attached as shown. Generally, the new room instrument is mounted in the same horizontal or vertical position as the existing instrument to be converted. Thus, the bracket can be detached and rotated 90° for alternate horizontal and vertical mounting positions as shown.

The plastic back is also marked on the reverse side with hole locations for mounting guard kits (when required) as shown.

Room Instrument Mounting Bracket and Terminal Connector

The room instrument mounting bracket is designed to accept the snap-in terminal connector as shown. Follow the orientation markings on both the bracket and the terminal connector when installing. The Johnson Controls pneumatic room instrument is furnished with barbed type air terminals which plug directly into the terminal connector.

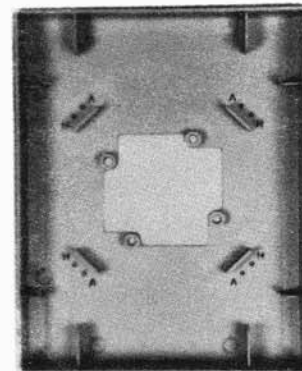
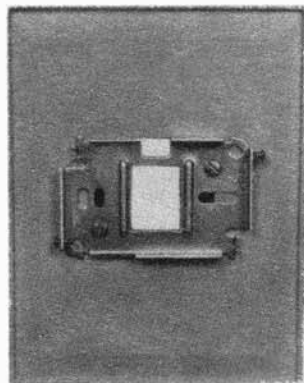
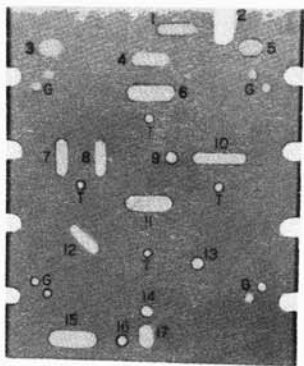

Subplate

Holes and slots 1-17 are used for attaching to installation site, the T-holes are used for attaching cover plate and room instrument mounting bracket and G-holes for guard mounting.

Cover Plate

Room instrument mounting bracket attached with (2) No. 6 x 3/8 in. self-tapping screws (detach and rotate 90° for alternate mounting requirements).

Cover Plate (Rear View)

Four pairs of holes marked H and V for drilling through to mount guard.

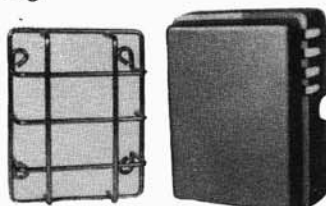

T-4002-3001
Wire Guard

T-4002-3004
Cast Guard

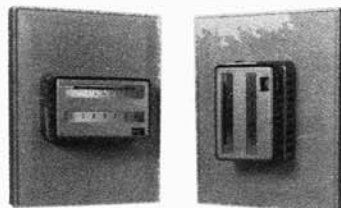

Converted Installations

(Above and Below)

Horizontal Mounting (left) and Vertical Mounting (right). Note: Upper right and lower left views with alternate bracket mounting positions.

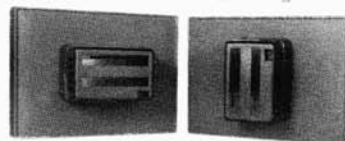

Snap-In Terminal Connector

Place top end into bracket first and press bottom end down to snap into bracket.

Procedures for Conversion

The following illustrations show various installation situations, air connection alterations, and subplate adaptations. Refer to page 12 for the cover plate and Johnson Controls replacement instrument mounting details.

Basic Steps of Installation:

1. Mount the subplate.
2. Install the pipehead and attach the tubing.
3. Install the cover plate.
4. Install the thermostat, calibrate if required.
5. Install the cover and faceplate.

Installing Thermostat Cover Faceplate *without* Window

Peel off the protective backing and the clear face covering on the desired faceplate without window, and install as illustrated in Figure 1.

Installing Window and Thermostat Cover Faceplate *with* Window

1. Insert the window into the lower right-hand corner opening in the front of the thermostat cover as illustrated in Figure 2.
2. Peel off the protective backing and the clear face covering on the faceplate *with* window and secure the window into place by installing the faceplate as illustrated in Figure 2.

Note: The window must be inserted prior to installing the faceplate.

Optional External Setpoint Adjustment for Thermostat Cover *with* Window

If desired, the setpoint may be adjusted without removing the cover. The breakout feature must be removed to access the setpoint dial. To do so proceed as follows:

- Viewing the cover from the outside and using a diagonal cutter, cut through the upper and lower portion of the first rib located beneath the window, remove rib and discard (refer to Figure 3). It is recommended that a true flush blade type tool be used to achieve a clean cut.
- A thermostat adjustment tool (T-4000-119, ordered separately) may be inserted through the breakout to adjust the thermostat without removing the cover.

Dial Strip

A stick-on dial strip may be used to change the thermostat setpoint dial from a horizontal to a vertical orientation. If vertical instrument installation is desired, proceed as follows:

1. Turn the setpoint dial clockwise until the stop pin keeps it from turning any further.
2. Allowing for a 30F° setpoint span (a 15F° span on either end of the desired setpoint), cut out the portion of the dial strip that corresponds to the desired setpoint.

Example: If the setpoint is 125°F, the span should be 110 to 140F°. Refer to Figure 4.

3. Peel off the protective backing on the dial strip.
4. Attach the dial strip to the setpoint dial, positioning the lowest number of the dial strip span over the lowest number on the dial (refer to Figure 5). Turn the dial counterclockwise while positioning the remainder of the dial strip.
5. Calibrate the instrument if required.

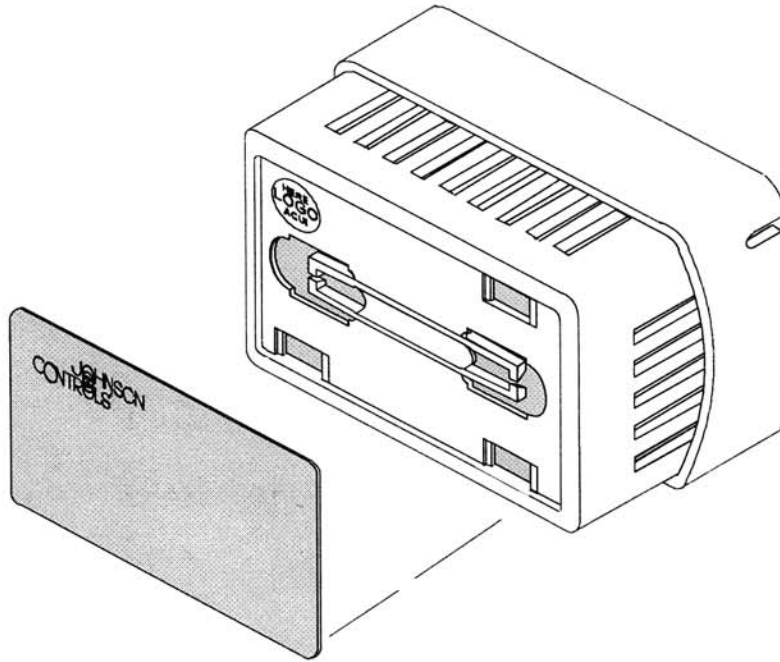

Figure 1: Installation of Thermostat Cover Faceplate without Window

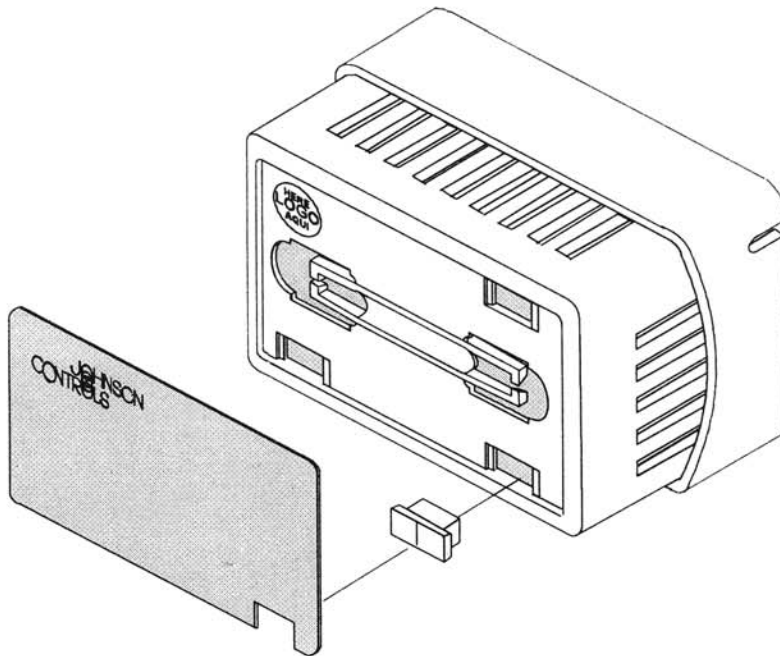

Figure 2: Installation of Window and Thermostat Cover Faceplate with Window

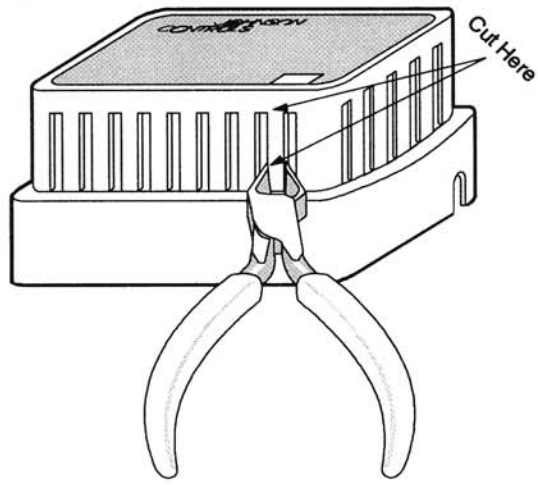

Figure 3: Removal of Breakout Feature for External Setpoint Adjustment

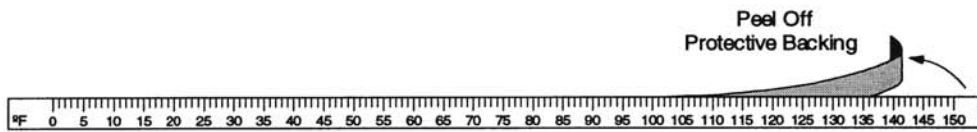

Figure 4: Dial Strip

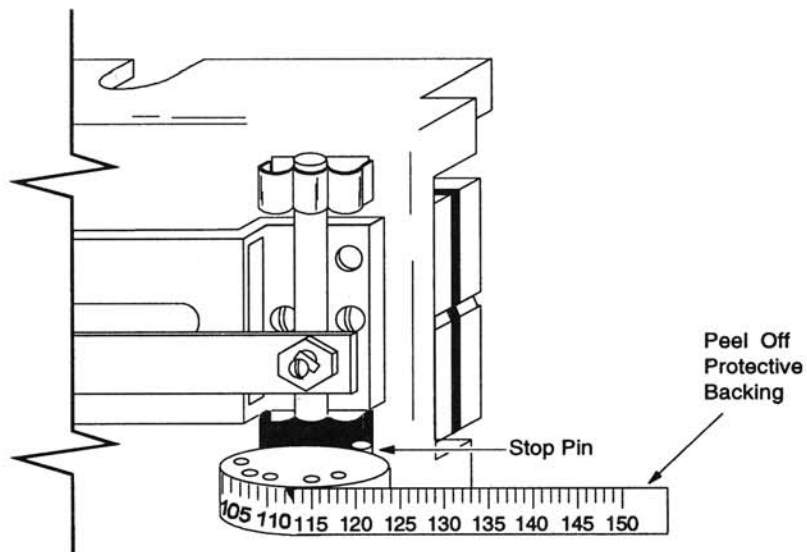
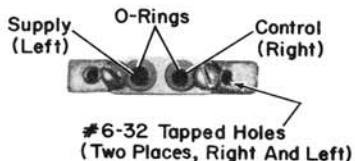

Figure 5: Applying Dial Strip to Setpoint Dial

Non-Johnson Controls Installations (Refer to Table 2)

Be sure to obtain a guard kit if required, before proceeding with the conversion.



Subplate for Mortar Joint Subplate for Wallboxes (See note.) (See note.)

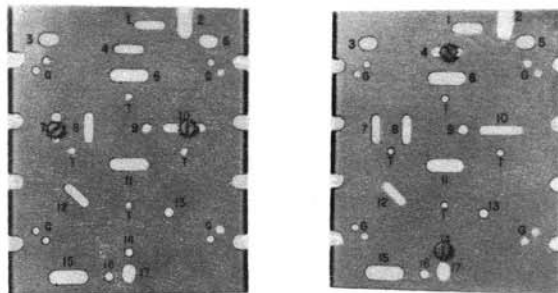

Note: Attach subplate with (2) No. 6-32 x 1-1/4 in. screws with star washers in Slots 8 and 10 for mortar joint and Slot 4 and Hole 14 for wallboxes. Refer to page 12 for the cover plate and Johnson Controls replacement instrument mounting details.

Mortar Joint

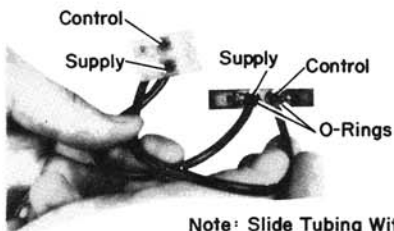

Note: Slide Tubing With Spring As Far As Possible Into O-Rings



Wallboxes

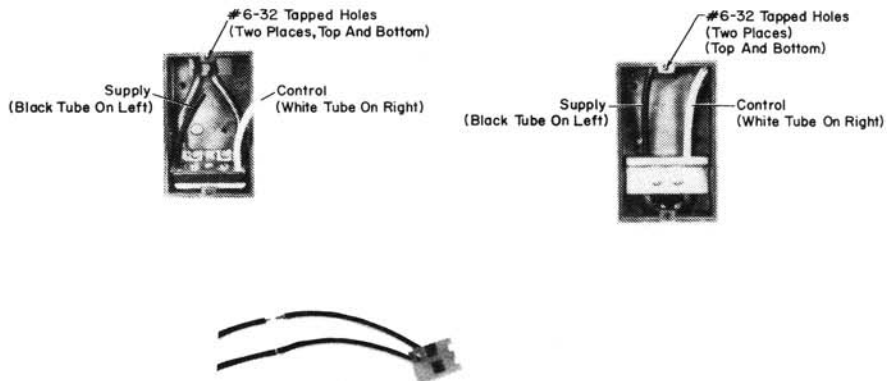

Adapt terminal connector to wallboxes above with 5/32 x 5/32 in. fittings.

Honeywell TO900 OR TP900 Series

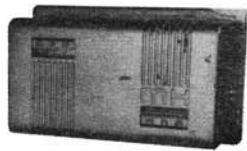

Cover

Exposed Tubing Unit

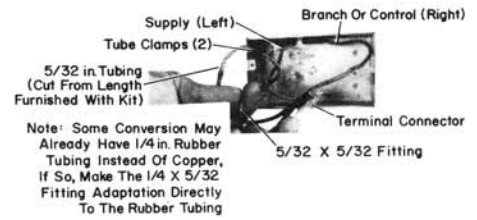
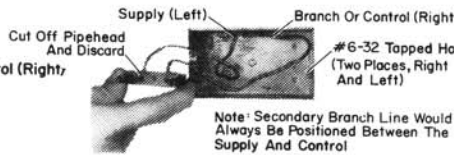
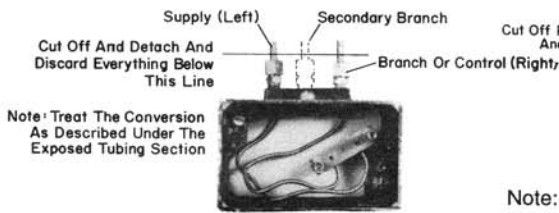

Wallbox

Subplate (See note.)

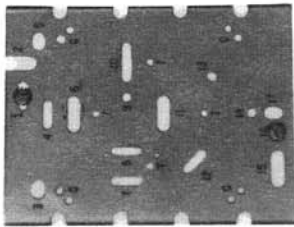

Note: Attach subplate to wallbox with (2) No. 6-32 x 1-1/4 in. screws with star washers in Slot 1 and Hole 16. Refer to page 12 for the cover plate and Johnson Controls replacement instrument mounting details.

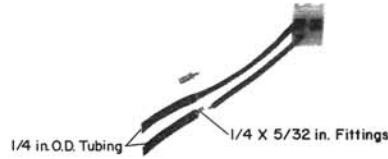

Terminal Connector Adaptation

Optional Terminal Connector Adaptation for Rubber Tubing

Honeywell TO910 OR TP910 Series



Cover

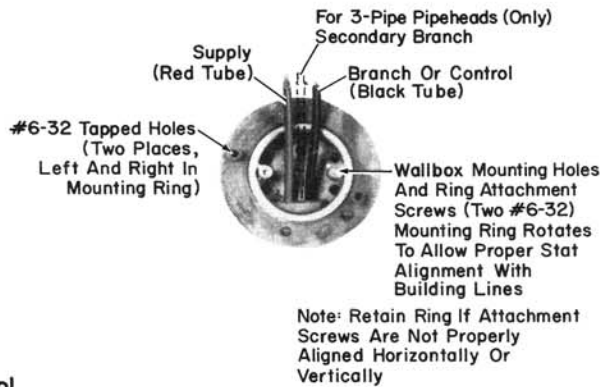

Wallbox with Mounting Ring

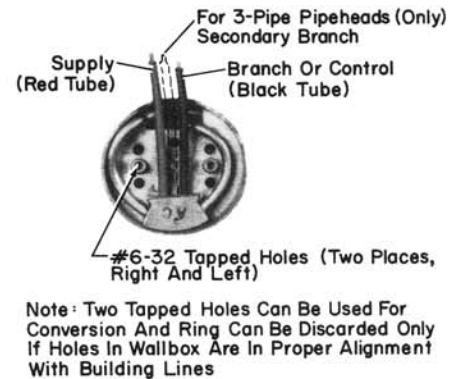

Wallbox with Mounting Ring Discarded

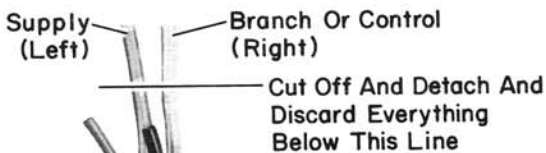

Note: Treat The Conversion As Described Under The Exposed Tubing Section

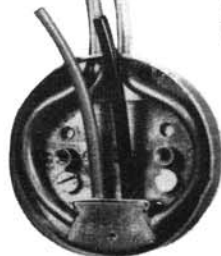

Exposed Tubing Unit



Adapt terminal connector to wallboxes above with 5/32 x 5/32 in. fittings.

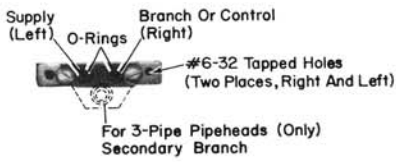

Mortar Joint

Note: Refer to page 12 for adapter cover plate and Johnson Controls replacement instrument mounting details.

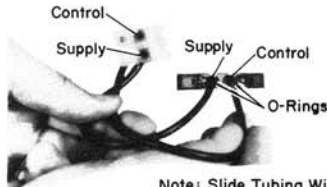

Note: Slide Tubing With Spring As Far As Possible Into O-Rings

Plug terminal connector leads into O-rings of mortar joint as shown above.

Subplate for Mortar Joint or Wallbox less Mounting Ring

Use (2) No. 6-32 x 1-1/4 in. screws with star washers in Slots 8 and 10.

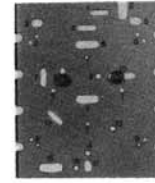

Subplate for Wallbox with Mounting Ring

Use (2) No. 6-32 x 7/16 in. screws with star washers in Slots 7 and 10.

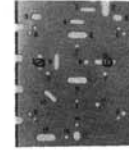

Honeywell TP970 Series

Cover

(Also available in horizontal mounting style.)

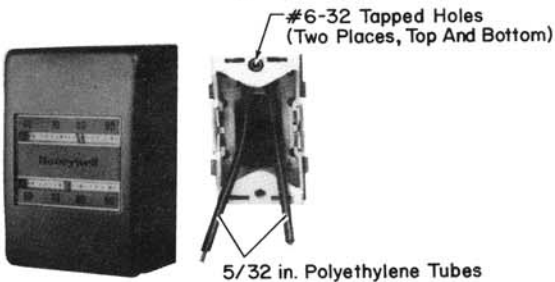

Shallow Wallbox

Adapt terminal connector to wallboxes on left with 5/32 x 5/32 fittings.



Note: Mount subplate to either wallbox using (2) No. 6-32 x 1-1/4 in. or 7/8 in. screws with star washers in Slots 7 and 10. Refer to page 12 for cover plate and Johnson Controls replacement instrument mounting details.

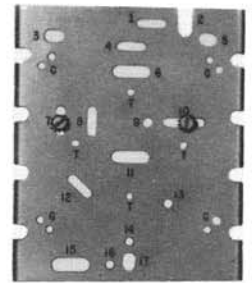

Subplate (See note.)

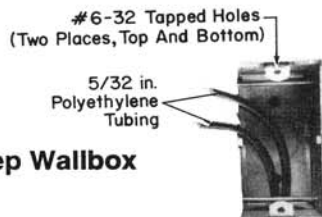

Deep Wallbox

Powers TH-832 "D" Series

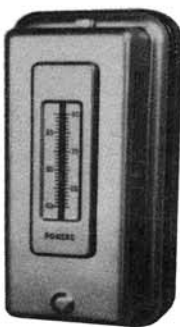

Cover

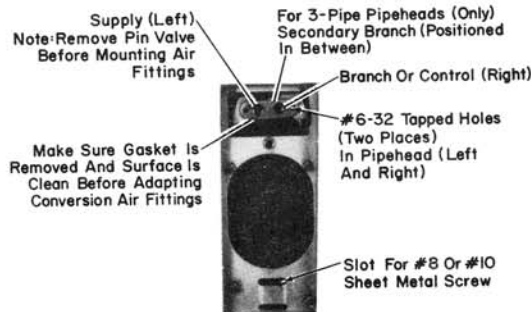

Groundplate

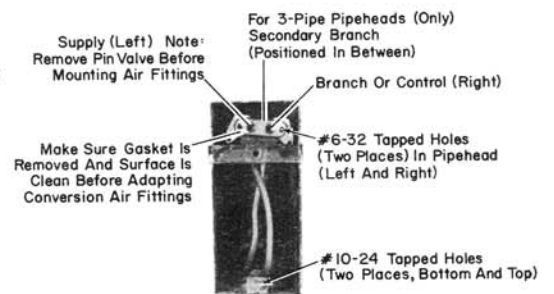

Wallbox

Powers TH382 "D" Series (Cont.)

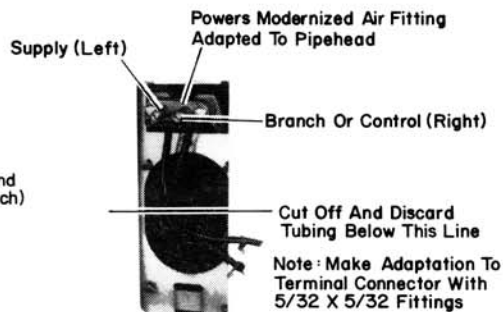
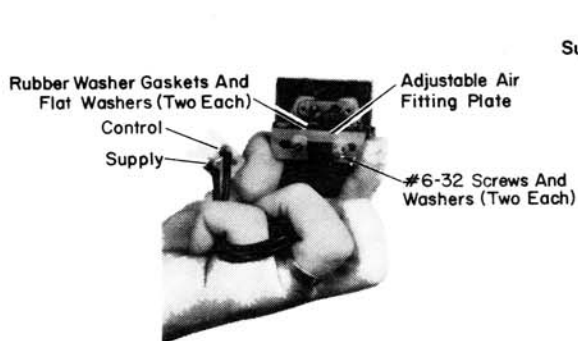

Adapt Terminal Connector leads to tubing on groundplate with modernized air fitting using 5/32 x 5/32 in. fittings.

Make terminal connector adaptation with adjustable pipehead for groundplate or wallbox installations.

Groundplate with Modernized Air-fitting Adapted

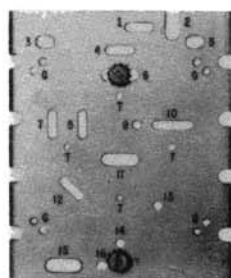

Subplate (See note.)

Note: On groundplate, mount subplate with (1) No. 10-24 x 1-1/2 in. screw with star washer in Slot 6 and (1) No. 8 sheet metal screw with star washer in Hole 17. On wallbox, mount subplate with (2) No. 10-24 x 1-1/2 in. screws with star washers in Slot 6 and Hole 17. Refer to page 12 for cover plate and Johnson Controls replacement instrument mounting details.

Powers T-21 Series



Covers

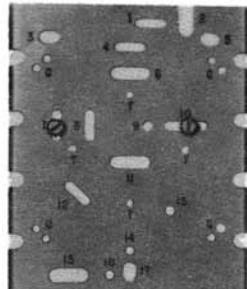

Subplate (See note.)

Note: Cut 5/32 Tubing At A 45° Angle Before Inserting Into O-Rings. Also, It May Be Necessary To Moisten Tubing To Facilitate Insertion Into O-Rings.

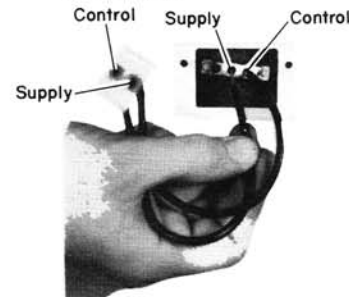

Note: On groundplate, mount subplate with (2) No. 6 x 1-1/2 in. sheet metal screws with star washers in Slots 7 and 10. On wallbox or mortar joint, mount subplate with (2) No. 4-40 x 1-5/8 in. machine screws with star washers in Slots 7 and 10. Refer to page 12 for the cover plate and Johnson Controls replacement instrument mounting detail.

Plug terminal connector leads into O-rings of groundplate, wallbox, or mortar joint pipehead.

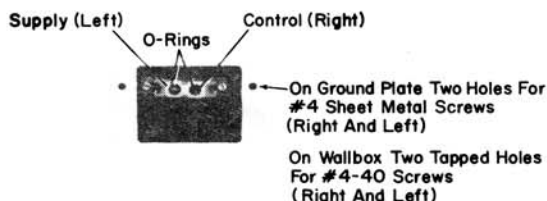

Note: Integral Steel Ball Check Valve Seals Supply When Instrument Is Removed

Groundplate or Wallbox

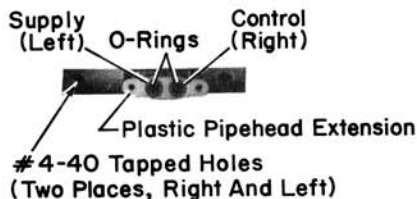

Mortar Joint

Powers TH-180

Cover

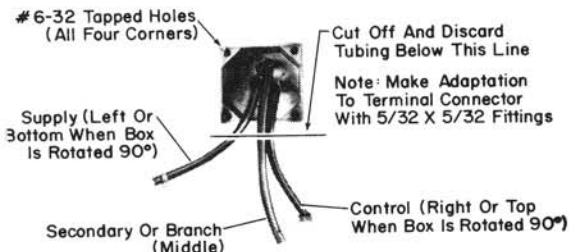

Plastic or Brick Wallbox



Adapt terminal connector to existing tubing with 5/32 x 5/32 fittings

Drywall

Note 1: On 3-Pipe Installations Secondary Branch Is In Between



Tube Clamps (Leave In Place)

Supply (Left) Control (Right)

Note 2: Make Adaptation To Terminal Connector With 5/32 X 5/32 Fittings

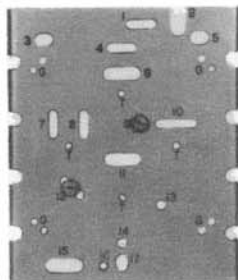

Subplate for Wallbox

(See note below.)

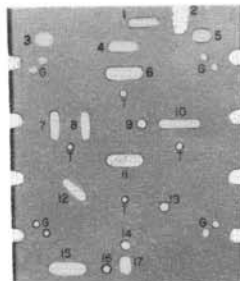

Subplate for Drywall

(See note left below.)

Note: Mount subplate using (2) No.6-32 x 1-1/4 in. screws with star washers in Hole 9 and Slot 12. Refer to page 12 for the cover plate and Johnson Controls replacement instrument mounting detail.

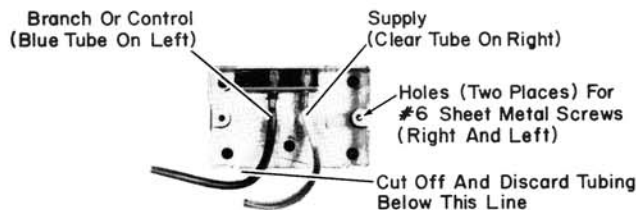

Robertshaw T-15

Note 1: On 3-Pipe Conversions, Tube Positions And Colors Are: Supply - Clear (Middle) Branch Or Control - Blue (Left) And Reset - Red (Right)

Note 2: Make Terminal Connector Adaptations With 5/32 X 5/32 Fittings

Cover

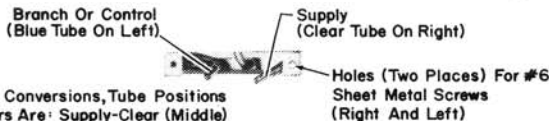

Note 1: On 3-Pipe Conversions, Tube Positions And Colors Are: Supply - Clear (Middle) Branch Or Control - Blue (Left) And Reset - Red (Right)

Note 2: Make Terminal Connector Adaptations With 5/32 X 5/32 Fittings

Later Style Mortar Joint

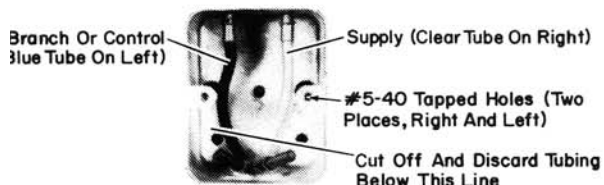

Note 1: On 3-Pipe Conversions, Tube Positions And Colors Are: Supply - Clear (Middle) Branch Or Control - Blue (Left) And Reset - Red (Right)

Note 2: Make Terminal Connector Adaptations With 5/32 X 5/32 Fittings



Later Style Wallbox

Adapt terminal connector leads to existing tubing with 5/32 x 5/32 in. fittings.

Early Style Shallow or Deep Wallbox

Robertshaw T-15 (Cont.)

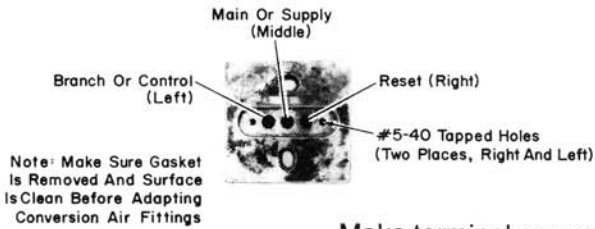

Make terminal connector adaptation with adjustable pipehead on right.

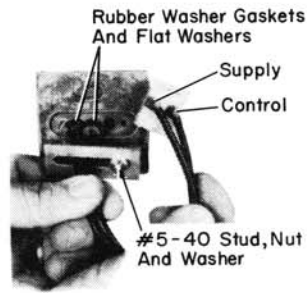

Early Style Mortar Joint

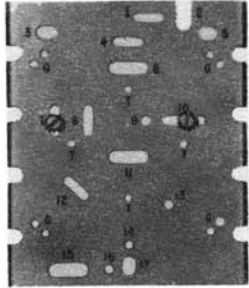

Subplate for Later Style Wallbox and Mortar Joint

Mount subplate with (2) No. 6 x 7/8 in. sheet metal screws with star washers in Slots 7 and 10. (See note.)

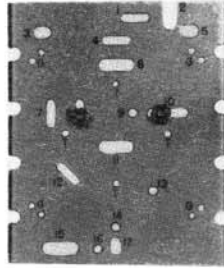

Subplate for Early Style Wallboxes

Mount subplate with (2) No. 5-40 x 1-1/4 in. screws with star washers in Slots 8 and 10. (See note.)

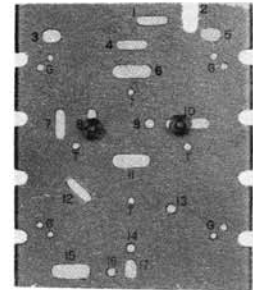

Subplate for Early Style Mortar Joints

Mount subplate over studs and secure with No. 5 hex nuts and star washers in Slots 8 and 10. (See note.)

Note: Refer to page 12 for the cover plate and Johnson Controls replacement instrument mounting details.

Draeger (ITT/Esсен/Johnson Controls), UPC, and Robertshaw T-18

Some of the details on the following non-Johnson Controls instruments are not completely known. Therefore, a definite procedure for conversion is not provided. However, the following characteristics are known:

On Draeger, the air lines are normally 1/4 in. O.D. and the subplate can be mounted to the installation site in Slot 3 and Hole 13.

On Robertshaw T-18 Plastic, the air lines are normally 5/32 in. O.D. plastic tubing and the subplate can be mounted to the installation site in Slots 8 and 10.

On UPC, the air lines are normally 1/4 in. O.D. plastic tubing and the subplate can be mounted to the installation site in Slots 8 and 10.



Robertshaw T-18 (Plastic)



UPC

Draeger (ITT)

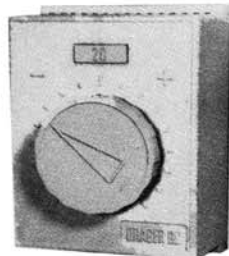

Refer to page 12 for the cover plate and Johnson Controls replacement instrument mounting details.

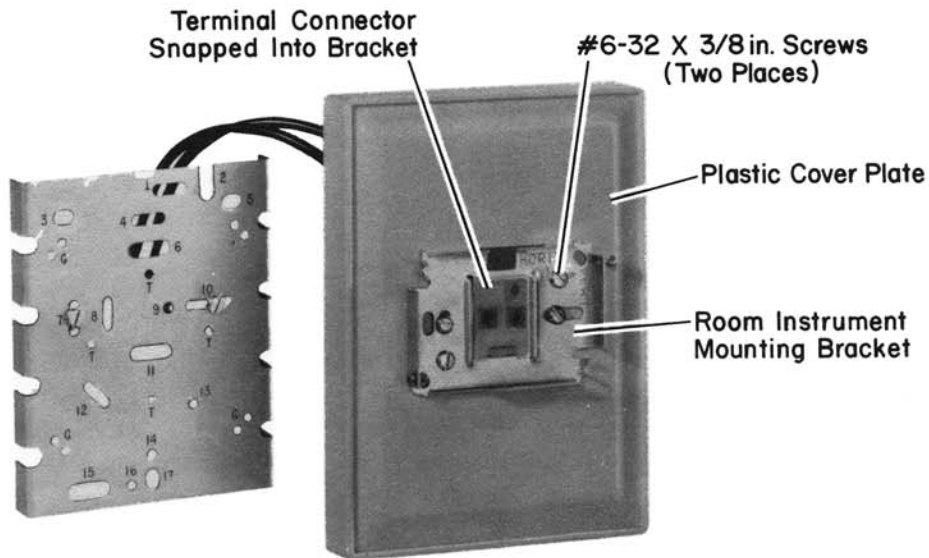

Plug the Johnson Controls replacement instrument into the terminal connector.
To complete the conversion, attach the cover to the room instrument mounting bracket.

**JOHNSON
CONTROLS**

Controls Group
507 E. Michigan Street
P.O. Box 423
Milwaukee, WI 53201

FAN 717.1
Pneumatic Control Manual
Printed in U.S.A.