

GASBADGE^{PRO}

Personal Single Gas Monitor

Activation • Operation • Troubleshooting



Part Number: 17123100-1
Revision: 5
Release Date: August 26, 2011

Table of Contents

Warnings and Cautionary Statements.....	3
Hardware Overview	5
Unpacking the Instrument.....	5
Display Overview	6
Activation.....	7
Countdown Screen	7
Operating Quick Start Guides.....	8
Basic Operating Flowchart.....	8
General Operation.....	11
Gas Monitoring Screen	11
Days Since Calibration.....	13
Days Until Calibration	14
Zero Initiate (Toxic Sensors Only – For Oxygen Sensors, Skip to Calibration Section)	15
Zeroing Failed	15
Zero Passed	16
Calibration.....	17
Calibration Passed.....	19
Calibration Failed.....	19
Bump Test.....	20
Peak Reading.....	21
TWA Gas Reading Screen	22
STEL Gas Reading Screen.....	23
Create Session	24
Event Log	25
Shutdown	26
Shutdown Password Screen	26
Configuration Mode.....	27
Introduction	27
Security Code.....	28
Calibration.....	29
Days Since Calibration.....	29
Days Until Calibration	29
Initiate Print.....	29
Low Alarm Setpoint.....	30
High Alarm Setpoint	32
TWA Alarm Setpoint.....	33
Set TWA Interval	34
STEL Alarm Setpoint.....	36
Set Calibration Gas Concentration.....	37
Set Clock	39
Set Calendar Month/Day.....	41
Set Security Code.....	43
Set Data Log Interval	45
Primary Display Setting	46
Always On Option	48

Set Confidence Indicator.....	49
Alarm Latch Setup	51
Zero In Field Option	52
Cal In Field Option	53
Cal Date View Option Screen.....	54
Calibration Past Due Alarm	56
Calibration Due Setpoint.....	57
Bump in Field Option	58
Bump Overdue Alarm Enable.....	59
Bump Test Interval.....	61
Bump Test Timeout	62
The DS2 Docking Station (Optional Accessory).....	63
Datalink (Optional Accessory)	63
Troubleshooting and Maintenance.....	64
Diagnosing Common Problems	64
Alarm Screen.....	64
Battery Failure.....	64
Sensor Missing Error	65
Unexpected Instrument Error.....	65
Replacing Parts	66
Replacing the Sensor.....	68
Sensor Specifications	70
Ordering Information – Accessories and Peripheral Equipment	72
General Specifications	73
Lifetime Warranty Policy	74
Limitation of Liability.....	74
Agency Certifications	77

Warnings and Cautionary Statements

IMPORTANT: Failure to perform certain procedures or note certain conditions may impair the performance of this product. For maximum safety and optimal performance, please read and follow the procedures and conditions listed below.



IMPORTANT: Read and understand this manual before operating.



WARNING: Substitution of components may impair intrinsic safety.



WARNING: The instrument contains a lithium battery which may leak or explode if the instrument is mistreated. Do not attempt to disassemble or dispose of in fire.



WARNING: To prevent ignition of flammable or combustible atmospheres, only change the battery in a non-hazardous location.



WARNING: To prevent ignition of flammable or combustible atmospheres, read, understand, and adhere to the manufacturer’s maintenance procedures.



WARNING: To prevent ignition of flammable or combustible atmospheres, only the following lithium CR2 batteries are approved for use with this instrument.

GasBadge® Pro Personal Single Gas Monitor

Manufacturer	Part Number
Panasonic	CR2
Sanyo	CR2
Duracell® Ultra	CR2/DLCR2
Kodak	CR2/KCR2
Energizer® e ² ®	1CR2/EL1CR2/CR2
Varta/Power One	CR2/CR2NP



The GasBadge Pro is certified for use within the ambient temperature range of -40° C to 60° C (-40° F to 140° F).



The GasBadge Pro complies with the relevant provisions of European ATEX Directive 94/9/EC and EMC Directive 89/336/EEC, amended by Directives 92/31/EEC, 92/31/EEC and 93/68/EEC.



The EC Type Examination Certificate is LCIE 10 ATEX 3088X with marking Code Ex ia I/IIC T4, for Equipment Group and Category I M1 and II 1G.



The GasBadge Pro devices (P/N: 18100060) are constructed with reference to published standards of Directive 72/23/EEC, to eliminate electrical risks and fulfill 1.2.7 of Annex II of Directive 94/9/EC.



The IECEx Certificate is LCI 10.0036X with marking Code Ex ia I/IIC T4, -40°C<Ta<60°C



The GasBadge Pro is marked with the symbol “Exia,” which is used by the Canadian Standards Association to designate the instrument as INTRINSICALLY SAFE. Note that the intrinsic safety is not certified by CSA when this instrument is used in atmospheres containing oxygen concentrations above 21%.



Prior to each day’s use, a bump test should be performed. If the instrument does not pass the bump test, a full calibration is recommended.



For purposes of minimizing electromagnetic interference (EMI) and radio-frequency interference (RFI) in the application environment, the alarm functions of the GasBadge Pro are unaffected when placed in close proximity to handheld radios¹. This applies to all sensors specified for this instrument.



Never cover or insert foreign objects into the alarm signal opening. The opening must remain clear and free of foreign objects, otherwise any alerts made during an alarm state may not be heard or identified.



Contact your service representative immediately if you suspect that the GasBadge Pro is working abnormally.



WARNING: The use of leather cases can produce inaccurate readings with diffusion (non-aspirated) gas detection instruments for specific monitoring applications. Leather cases should be used **ONLY** as carrying cases, and **NOT** for continuous monitoring, with diffusion instruments configured to measure gases **other than** O₂, CO, CO₂, H₂S, and combustible gases (LEL/CH₄).

¹ Within 1 meter of a handheld radio emitting an electromagnetic signal of up to 5 watts in the frequency range of 80 MHz to 2.4 GHz.

Hardware Overview

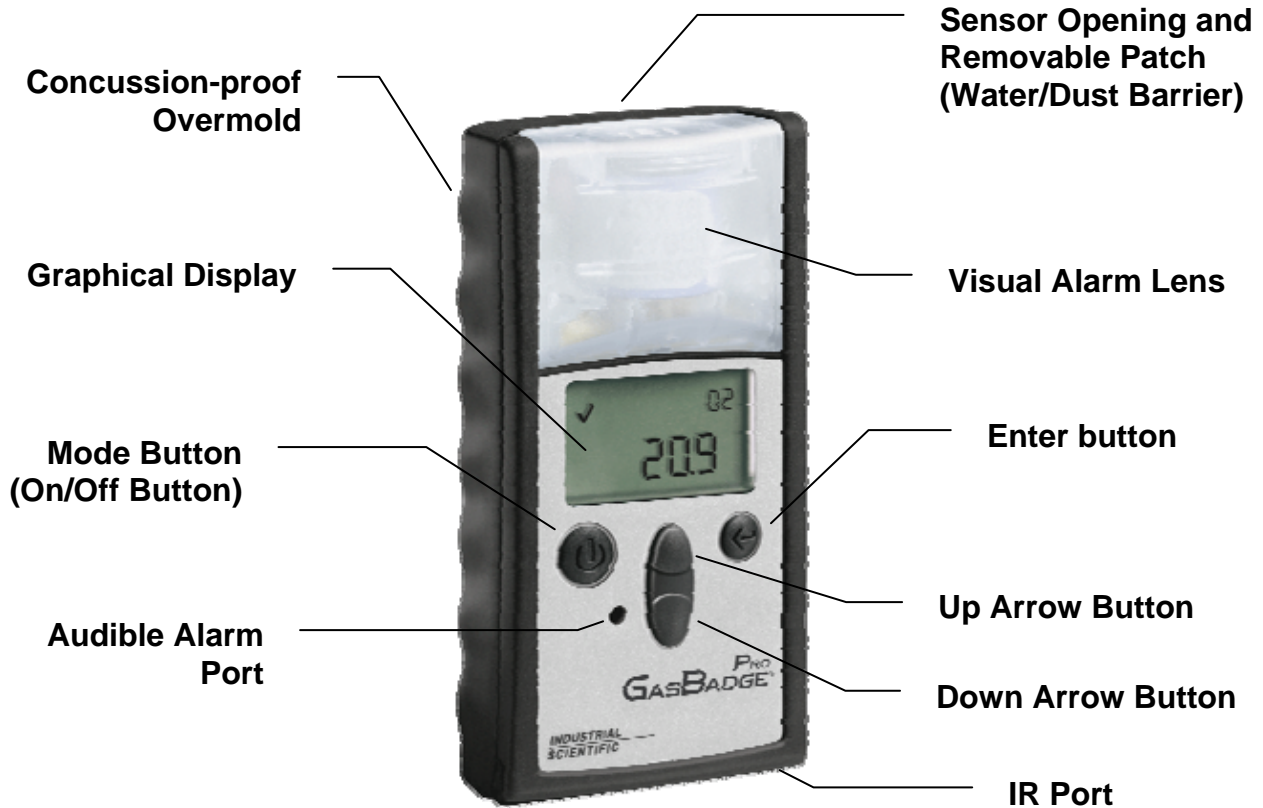

Unpacking the Instrument

The shipping box should contain the following items. Account for each item before discarding the box.

Quantity	Part Number	Description
1	18100060-x	GasBadge® Pro Monitor
1	17120908	Belt Clip
1	17123100	Manual
1	17124033	Cal-Cup
1	17093659	Urethane Tubing

After unpacking, if any listed item is missing, contact either your local distributor of Industrial Scientific products or call Industrial Scientific Corporation at 1-800-DETECTS (338-3287) in the United States and Canada, or 412-788-4353.

Display Overview

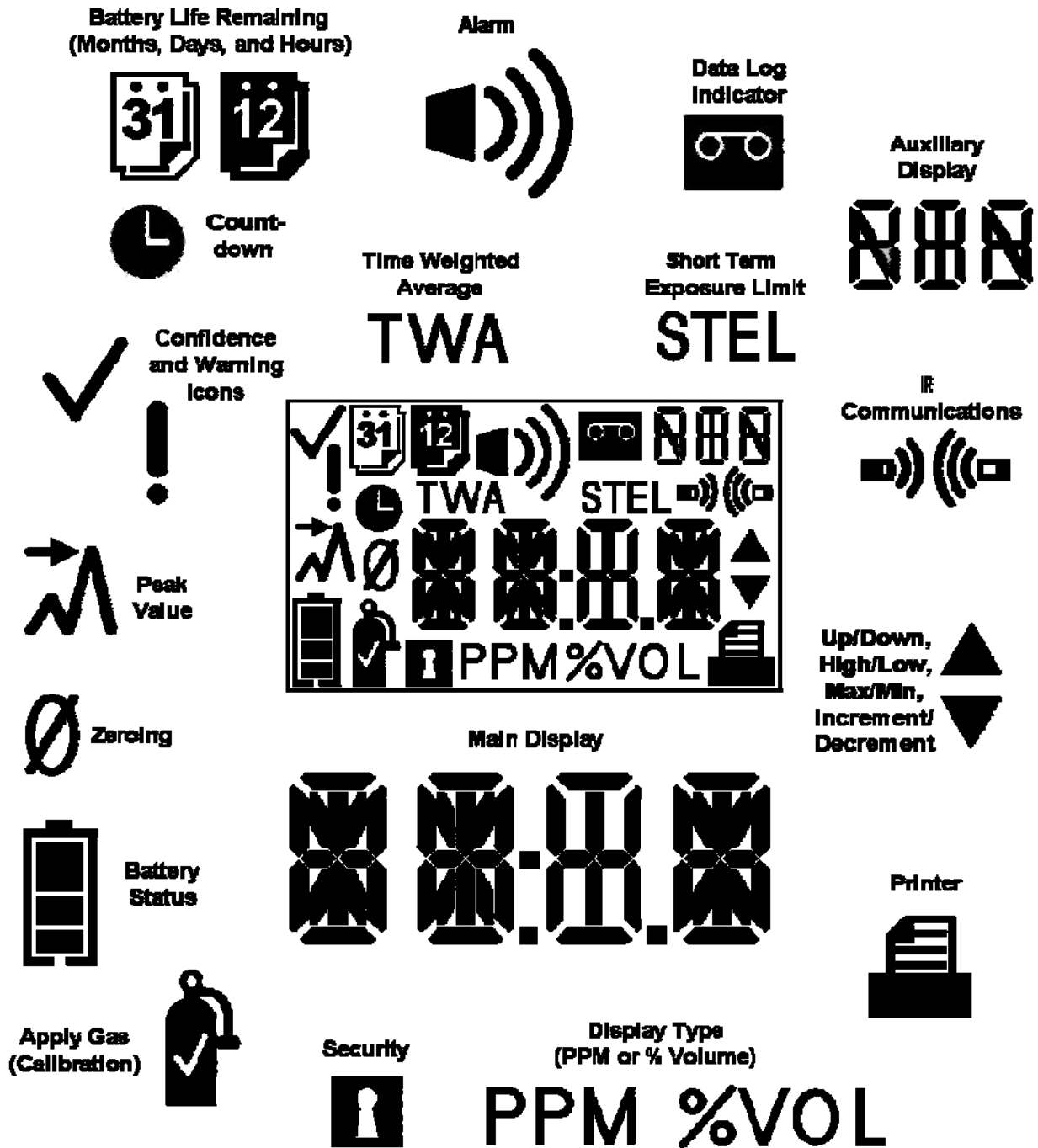

LCD Display Panel Overview

Activation

To turn on the GasBadge Pro, hold the Mode button for at least 3 seconds. Each alarm indicator – the left LED, the right LED, the speaker, the vibrating alarm, and the backlight – is tested for one second. Following the segment and alarm indicator test, the instrument displays the software version. If the Days Since/Until Calibration option is enabled, this screen is displayed.



Activating the GasBadge Pro Personal Monitor

NOTE: Any button press activates the backlight for a period of 5 seconds.

Countdown Screen

The countdown screen is entered after the Software Version screen times out. The primary display shows a decrementing countdown from 20 seconds.

To enter the Configuration Mode, press the up and down arrow buttons simultaneously for 3 seconds during this countdown. The device will display the Enter Security Code screen (assuming the security code has been set to a number greater than zero).

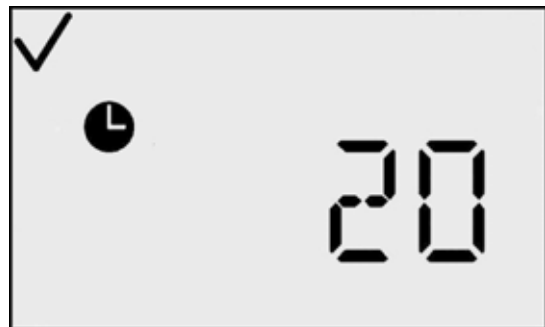

Countdown Screen

If the security code is set to zero, then the Security Code screen is bypassed and the Zero Initiate screen (for toxic sensors) or Cal Initiate screen (for O₂ sensors) is displayed. If no buttons are pressed, the GasBadge Pro proceeds to the Gas Monitoring screen after the countdown reaches zero.

The confidence Checkmark indicator is active at this point, indicating that all internal checks have passed.

Operating Quick Start Guides

Basic Operating Flowchart

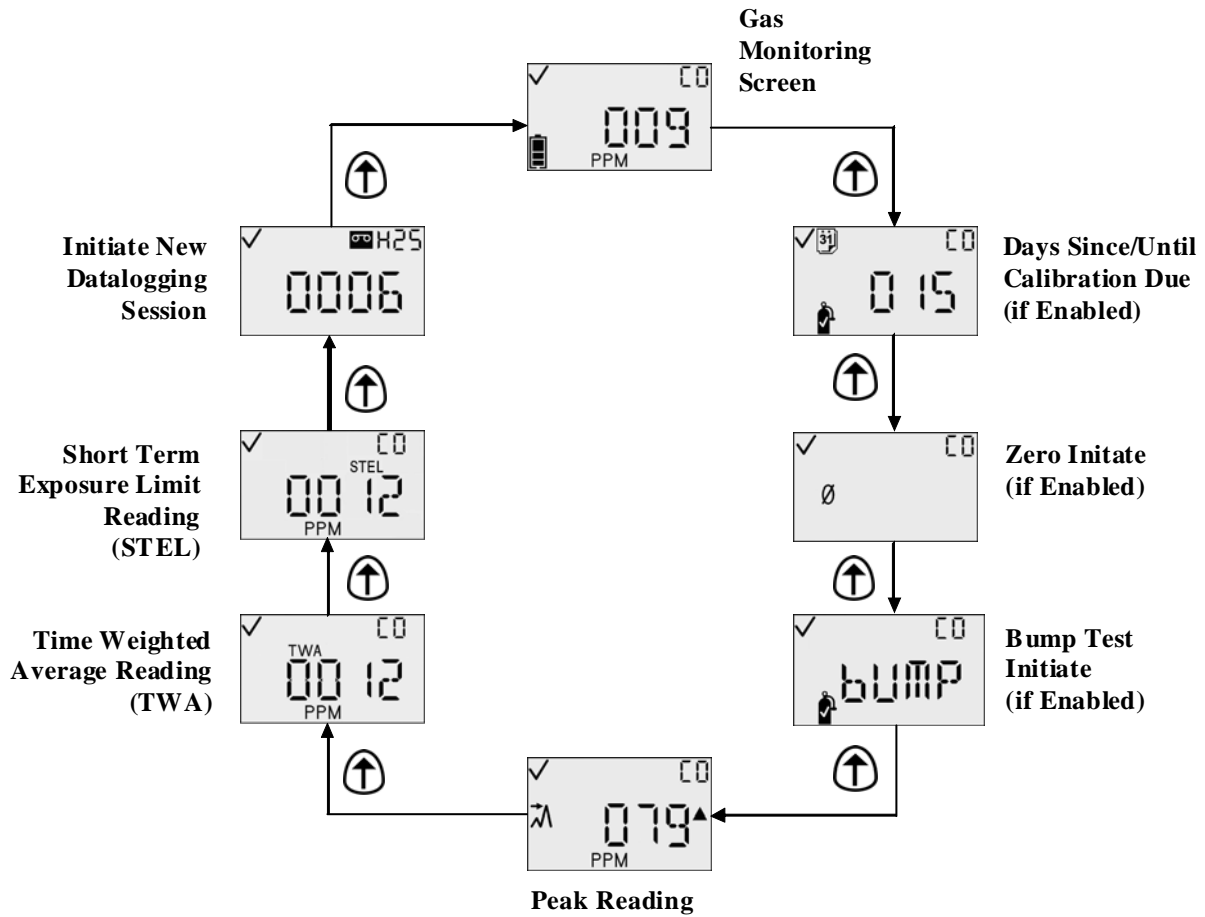

Configuration Mode Flowchart

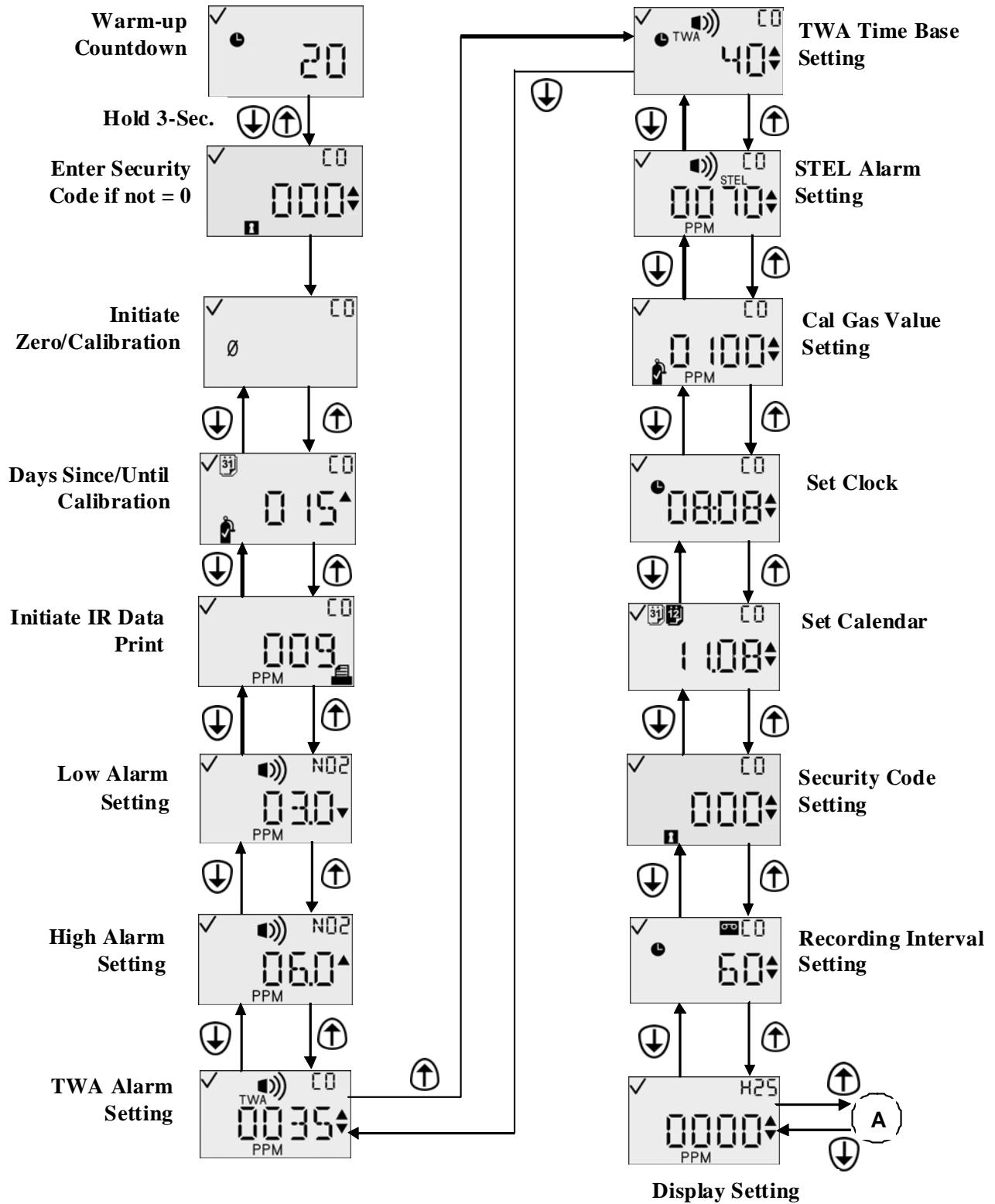

Configuration Mode Flowchart (Continued)

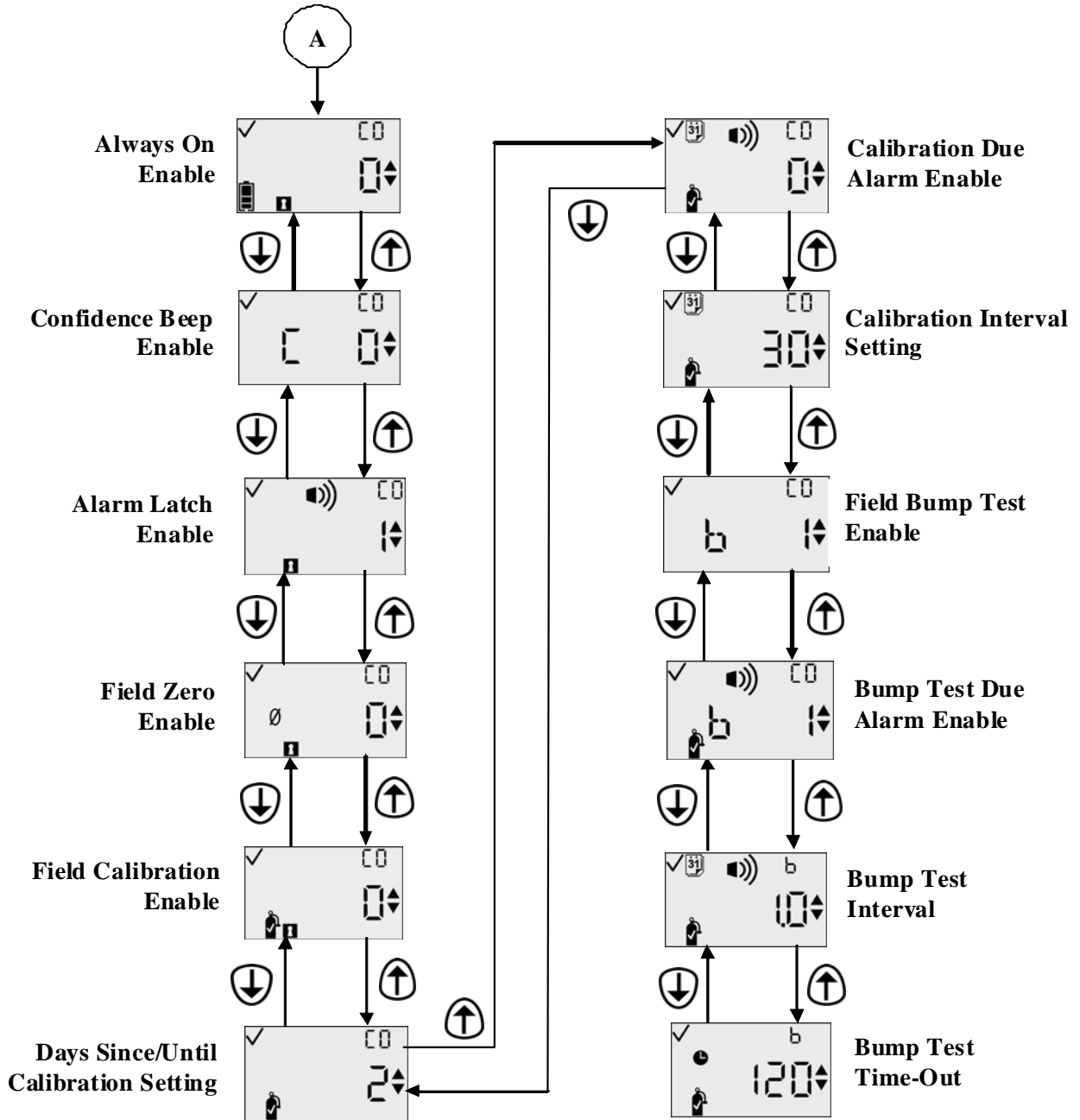

General Operation

Normal operation modes include the following:

- Gas Monitoring
- Days Since/Until Calibration (if enabled)
- Zero Initiate (if enabled)
- Calibration (if enabled)
- Peak Reading
- Time Weighted Average (TWA) Reading (except O₂)
- Short Term Exposure Limit (STEL) Reading (except O₂)
- Create Session.

The operation modes are explained in the sections that follow.

Gas Monitoring Screen

The primary operating screen is the Gas Monitoring screen. The Gas Monitoring screen may utilize one of three displays:

- Concentration in PPM (for toxic sensors)
- Concentration in Percent Volume (for oxygen sensors)
- Gas Sensor Type Only (selectable for either sensor type).

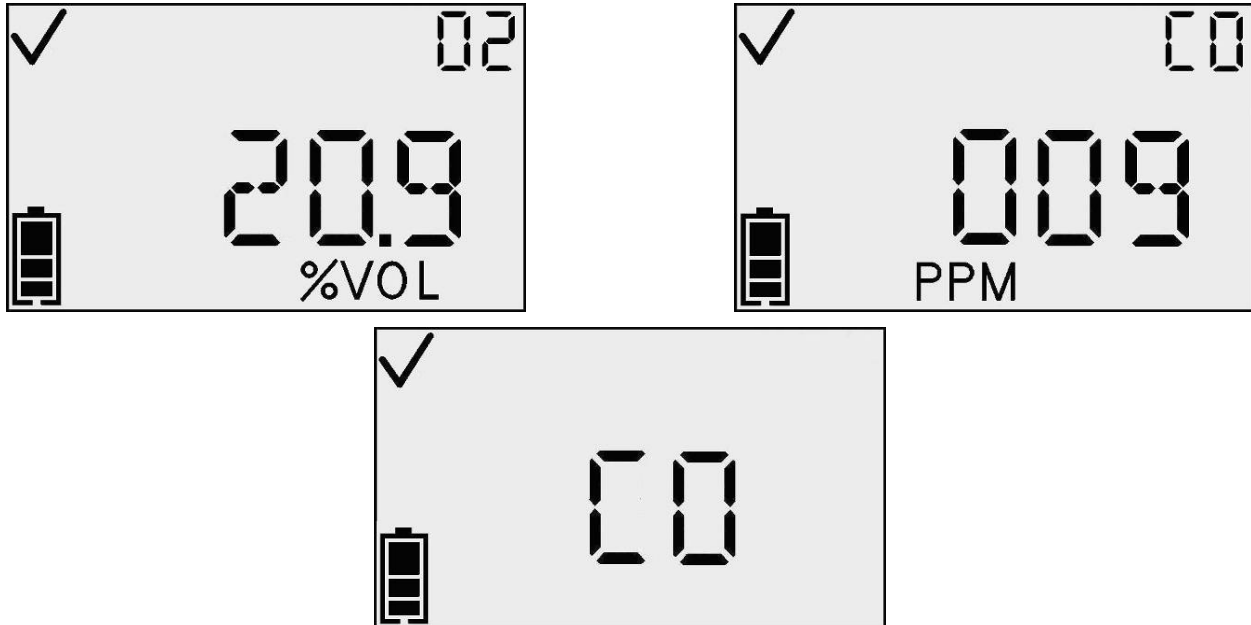

Gas Monitoring Screens

NOTE: The Enter button activates the backlight and initiates IR print.

GasBadge® Pro Personal Single Gas Monitor

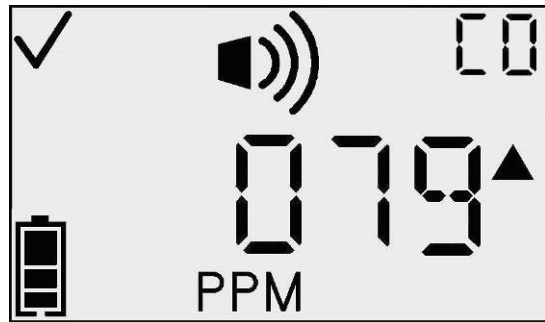

In the presence of a gas concentration that exceeds the low or high level threshold, the instrument enters an alarm screen. Alarm detection in any of the instrument's normal operating screens – the battery life, peak, or initiate print screens – forces a transition back to the Gas Monitoring screen. The alarm screen is indicated on the display by the Alarm indicator and either the Up indicator or Down indicator which designate a high or low alarm, respectively.



High Alarm Screen

These icons are in addition to the values and icons normally displayed in the current monitoring screen. From this screen, the Up Arrow button can toggle through the menus.

Actions Available from Monitor Screen

Action	Response
Enter button press 	Clear any latched alarms if latch alarms feature is enabled and initiate the printing of the event log.
Up Arrow button press 	If View Cal Date is set, go to Days Since/Until Calibration screen. If View Cal Date is not set, go to: (a) Zero Initiate screen (if Zero In Field is enabled), or (b) Peak Gas Reading screen (if Zero In Field is disabled).

NOTE: The battery indicator is active and indicates the battery life remaining.

NOTE: In an over-range condition, the display shows a blinking “OR.” Any over-range values in the event log or peaks are truncated at the measurement range of the sensor. The instrument stores the number of over-range conditions that occur. This number is accessible through the ModBus interface.

Days Since Calibration

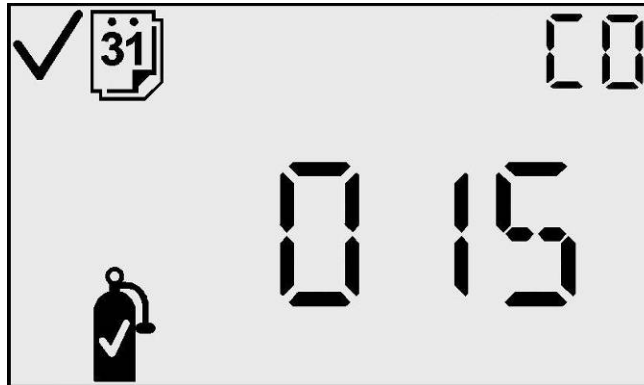

The primary display of the Days Since Calibration screen indicates the number of days that have passed since the last calibration. The Days indicator displays the number as days, and the Gas Bottle indicator shows that this is a calibration issue.

This screen is displayed if the View Cal Date option is turned on, and the View Last/Next Cal Date option is set to view the last cal date.



Days Since Calibration Screen

Actions Available from the Days Since Calibration Screen

Action	Response
Up Arrow button press 	If View Cal Date is set, go to Days Since/Until Calibration screen. If View Cal Date is not set, go to: (c) Zero Initiate screen (if Zero In Field is enabled), or (d) Peak Gas Reading screen (if Zero In Field is disabled).
30 second timeout 	Go to Gas Monitoring screen.

Days Until Calibration

The primary display of the Days Until Calibration screen indicates the number of days until the next calibration is due. The Days indicator is active to designate this number as days, and the Gas Bottle indicator is active to designate it as a calibration issue. This screen is displayed if the View Cal Date option is turned on, and the View Last/Next Cal Date option is set to view the next cal date.

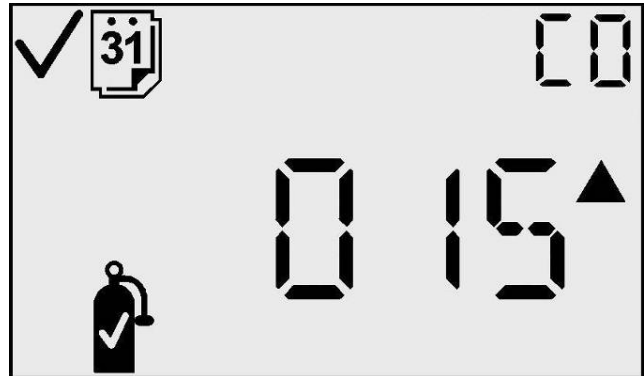



Figure 1- Days Since Calibration

Actions Available from the Days Until Calibration Screen

Action	Response
Up Arrow button press 	If Zero In Field is enabled, go to Zero Initiate screen (for toxic sensor) or Cal Initiate (for O ₂ sensor). If Zero In Field is disabled, go to Peak Gas Reading screen.
30 second timeout 	Go to Gas Monitoring screen.

Zero Initiate (Toxic Sensors Only – For Oxygen Sensors, Skip to Calibration Section)

IMPORTANT: Before zeroing, ensure the instrument is located in a fresh air environment. If background gas is present, the use of a zero air cylinder is recommended.

The Zero screen allows you to begin the zeroing process (for toxic sensors), by pressing the Enter button. The Zero icon blinks, signifying that zeroing will begin if you press Enter. For oxygen sensors, this screen is not displayed. Pressing the Up Arrow button at this screen navigates to the Peak screen.

While zeroing, the display shows the Zero icon, the gas type, and a blinking Clock icon to show that this step takes some time. If the zeroing process fails, a transition is made to the Zero Fail screen. If the zeroing passes, a transition is made to the Zero Pass screen.

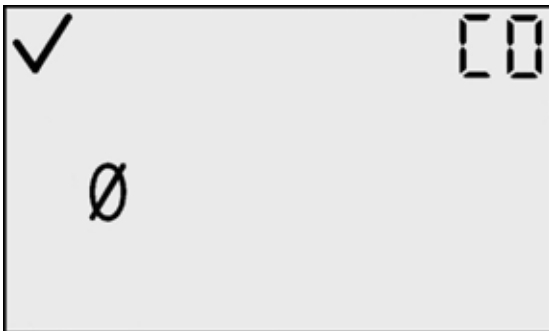

Zero Initiate Screen



Zeroing In Process

Zeroing Failed

The Zeroing Failed screen (with the Zero icon and a flashing Warning icon) indicates to the user that the zeroing process could not achieve a sensor offset correction within the allowable limits of the instrument. The instrument is placed in periodic alarm (one alarm burst every 15 seconds) while in this condition.



Zeroing Failed Screen

From this screen, the user only has the option to repeat the zeroing process by pressing the Enter button.

Actions Available from the Zeroing Failed Screen

Action	Response
Enter button press 	Go to Zeroing In Process screen.

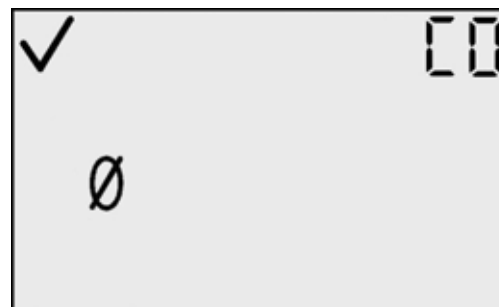

Zero Passed

The Zero Passed screen shows that the zero process completed successfully. After 5 seconds, the Calibration screen is displayed.



Zero Passed Screen

Actions Available from the Zero Passed Screen

Action	Response
Mode button press 	If Zero Process entered from Configuration mode, then go to Zero Initiate in Configuration Mode. If Zero Process entered from Monitoring mode, then go to Gas Monitoring screen.
Enter button press 	Go to Calibration Initiate screen.
5 second timeout 	Go to Calibration Initiate screen.

Calibration

Gas detection instruments are potentially life-saving devices. Recognizing this fact, Industrial Scientific Corporation recommends that a functional (“bump”) test be performed on every instrument prior to each day’s use. A functional test is defined as a brief exposure of the monitor to a concentration of gas(es) in excess of the lowest alarm setpoint for each sensor for the purpose of verifying sensor and alarm operation and is not intended to be a measure of the accuracy of the instrument.

Industrial Scientific further recommends that a full instrument calibration be performed using a certified concentration(s) of Industrial Scientific branded calibration gas(es) monthly to ensure maximum accuracy. Use of calibration gases from manufacturers other than Industrial Scientific may void product warranties and limit liability claims against the manufacturer.

If an instrument fails to operate properly following any functional “bump” test, a full calibration should be performed prior to use.

Calibrating with Ambient Air (Oxygen Sensors Only)

NOTE: Clean ambient air may be used for oxygen calibration. If a clean air environment is in question or if a zero air cylinder calibration is preferred, please skip to the Calibrating with Gas Cylinders section.

On the Calibration screen, the Cal Gas Bottle icon flashes, notifying you to press Enter to begin calibration. Upon completion of calibration, the instrument beeps once, and either Cal Passed (✓) or Cal Failed (!) is displayed along with the sensor span reserve.



Calibration Cup



Calibration Initiate Screen

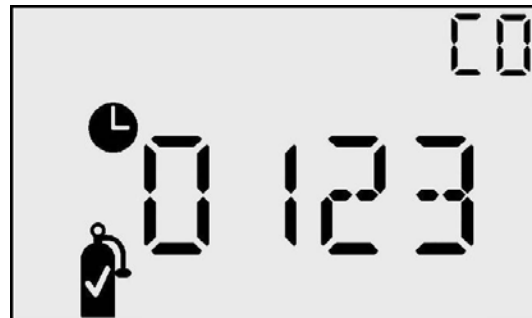

Cal Leveling Off Screen

Calibrating with Gas Cylinders (Toxic Sensors or Zero Air Cylinder Calibration)

Place the supplied calibration cup onto the top of the instrument and connect the calibration cup to the gas cylinder with the supplied tubing.

GasBadge® Pro Personal Single Gas Monitor

On the Calibration screen, the Cal Gas Bottle icon flashes, notifying you to apply the gas concentration shown and press Enter to begin calibration. Calibrate using a flow rate of 0.5 LPM.

Upon completion of calibration, the instrument beeps once and either the Cal Passed (✓) or Cal Failed (!) icon is displayed along with the sensor span reserve.



Cal Passed (✓) Screen



Cal Failed (!) Screen

Actions Available from the Calibration Initiate Screen

Action		Response
Enter button press		Initiates calibration.
Up button press		Go to Peak Gas Reading.
Mode button press		If entered from Configuration mode, then go to Zero Initiate in Configuration Mode.
30 second timeout		If entered from Monitoring mode, then go to Gas Monitoring screen.

Actions Available During Calibration

Action		Response (O ₂ or Toxic Sensor)
Mode button press		Aborts calibration.
Calibration passes		Go to Cal Passed.
Calibration fails		Go to Cal Failed.
5 minute timeout		Go to Cal Failed.

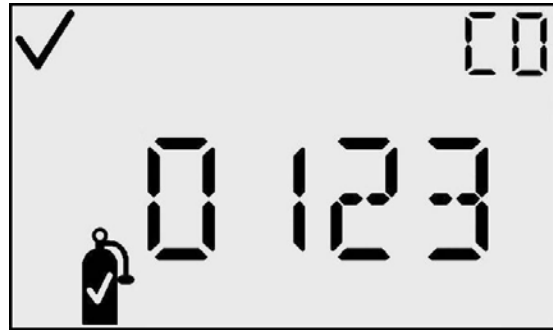

Calibration Passed

The Calibration Passed screen indicates that the instrument spanning process has completed successfully. The primary character display indicates the sensor span reserve. The Checkmark indicator is active to announce that the calibration process has passed. Once the Enter button is pressed, or after 30 seconds displaying this screen, a transition is made back to the Zero or Cal Initiate screen.



Cal Passed Screen

Actions Available from the Calibration Passed Screen

Action	Cal Passed (✓) Response	
	Toxic Sensor	Oxygen Sensor
Mode button press 	If entered from Configuration Mode, go to the Zero Initiate screen in Configuration mode.	If entered from Configuration Mode, go to the Cal Initiate screen in Configuration mode.
Enter button press 		
30 second timeout 	If entered from Monitor Mode, go to the Gas Monitoring screen.	If entered from Monitor Mode, go to the Gas Monitoring screen.

Calibration Failed

The Cal Failed screen indicates that the instrument calibration process has completed unsuccessfully. The primary character display indicates the last span reserve reading. The Checkmark indicator is NOT active and the Warning indicator blinks to announce that the calibration process has failed.

When the Enter button is pressed, a transfer is made back to the Zeroing state, to re-attempt the calibration process.

While in this condition, the instrument is placed in periodic alarm (one alarm burst every 15 seconds) until a successful calibration is performed.



Spanning Failed Screen

Actions Available from the Calibration Failed Screen



Action	Cal Failed (!) Response	
	Toxic Sensor	Oxygen Sensor
Enter button press 	Go to Zeroing In Process screen.	Go to Cal Leveling Off screen.

Bump Test

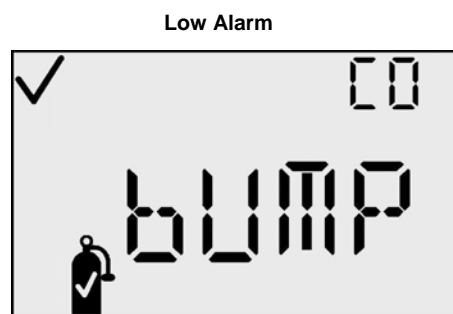
The bump test screen allows the user to initiate and perform a manual bump test of the instrument using calibration gas. (This screen will only be seen if the bump test option is enabled in the configuration mode.) After initiating the bump test by pressing the Enter button at this screen, the user will apply the calibration gas to the instrument as described previously under Calibration. If the sensor responds to 50% of the calibration gas value within the timeout specified in the configuration mode the instrument will pass the bump test. If the sensor readings do not exceed the alarm limits within the timeout period, the instrument will fail the bump test and a bump fault screen ("bF") will display. The instrument is placed in periodic alarm until a successful bump test is performed. If the bump overdue alarm is enabled in the configuration mode, the bump test screen will appear on the instrument and remain until a bump test of the instrument is completed successfully.



Actions Available from the Bump Test Screen

Action		Response
Enter button press		Initiate bump test.
Up Arrow button press		Go to Peak Reading screen.
30 second timeout		Go to Gas Monitoring screen.

Peak Reading

The Peak Gas Reading screen presents the peak reading since the last time the peak was cleared. The peak reading is accompanied by the appropriate concentration indicator (PPM or %VOL) and the corresponding Up indicator or Down indicator, representing a maximum reading (for toxics) or minimum reading (for oxygen), respectively. After 30 seconds, this screen will timeout and return to the main monitoring screen.

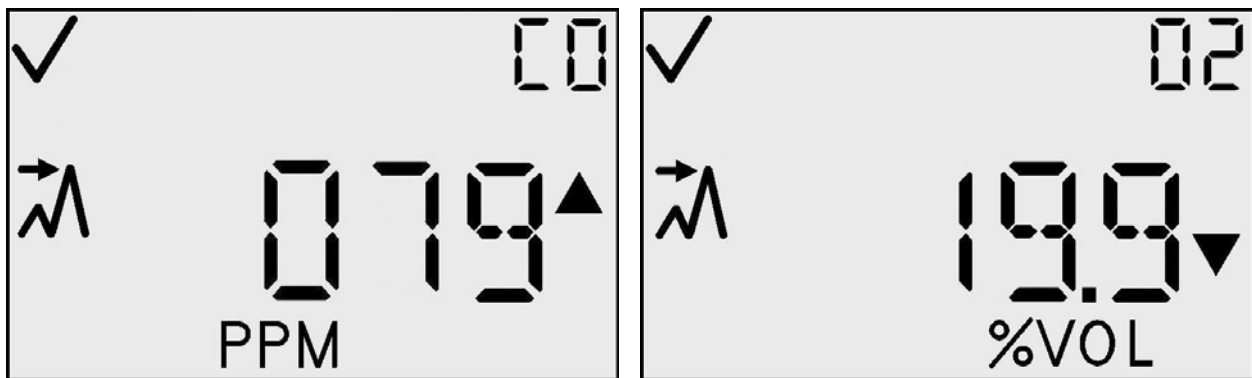

Pressing the Enter button on the Peak Gas Reading screen clears the peak value. On O₂ instruments, the depletion peak is cleared to 20.9%.

NOTE: The GasBadge Pro retains the maximum gas reading (for a toxic sensor) and the minimum gas reading (for an O₂ sensor) for later viewing.



Peak Reading Toxic (Left) and Peak Reading Oxygen Depletion (Right) Screens

Actions Available from the Peak Reading Screen

Action	Response
Enter button press 	Clears peak. If O ₂ sensor, set peak to 20.9%. If toxic sensor, set peak to 0 PPM.
Up Arrow button press 	Go to Create Session screen.
30 second timeout 	Go to Gas Monitoring screen.

TWA Gas Reading Screen

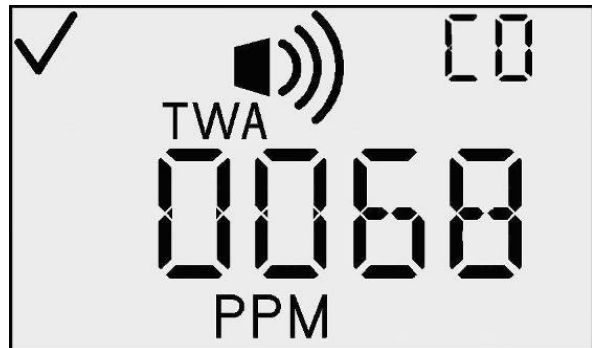
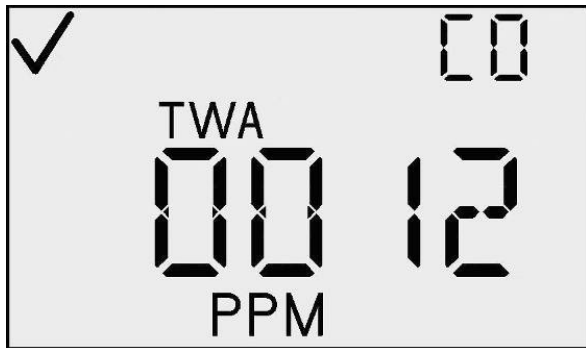

The TWA Gas Reading screen is one of the normal operating states. The primary character display of the instrument presents the time weighted average (TWA) over the last 1 to 40 hours, as set by the user. The TWA reading is accompanied by the PPM concentration indicator and the TWA indicator. The instrument continues to indicate the sensor type on the auxiliary display and the Checkmark indicator if appropriate. Clearing the TWA from this menu creates a new datalog session. The TWA value is saved in non-volatile memory when power is turned off.



TWA Screen and TWA Alarm Screen

If there is a TWA alarm, the Alarm indicator is also active, and the LED, speaker, and vibrator all act as if a low gas alarm had occurred.

Actions Available from the TWA Screen

Action	Response
Enter button press 	Clears TWA and begins a new datalog session.
Up Arrow button press 	Go to STEL Gas Reading screen.
30 second timeout 	Go to Gas Monitoring screen.

STEL Gas Reading Screen



The STEL Gas Reading screen is one of the normal operating states. The primary character display of the instrument presents the STEL over the last 15 minutes. The STEL reading is accompanied by the PPM concentration indicator and the STEL indicator. The instrument continues to indicate the sensor type on the auxiliary display and the Checkmark indicator if appropriate.



STEL Screen and STEL Alarm Screens

If there is a STEL alarm, the Alarm indicator is also active, and the LED, speaker, and vibrator all act as if a high gas alarm has occurred.

Actions Available from the STEL Screen

Action	Response
Up Arrow button press 	Go to Create Session screen.
30 second timeout 	Go to Gas Monitoring screen.
Gas alarm event (STEL, TWA, High or Low Alarm)	Go to Gas Monitoring screen.

Create Session

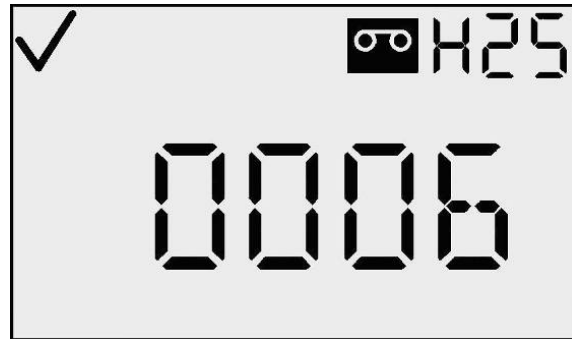

The Create Session screen is one of the normal operating states. On this screen, the primary character display shows the current session being logged, the Check Mark icon, and the Datalog indicator. Pressing the enter button automatically creates a new datalog session in the data logger. Upon download of the logged data, the user should be able to identify that session.



Create Session

NOTE: The initial session number is 000.

Actions Available from the Create Session Screen

Action		Response
Enter button press		Create a new datalog session.
Up Arrow button press		Go to Gas Monitoring screen.
30 second timeout		Go to Gas Monitoring screen.

The logging interval is programmable from 2 seconds to 5 minute in 2 second increments. The data logger logs three pieces of information: (1) the average gas reading within the logging interval selected (so if the logging interval is set to 1 minute, then the data logger calculates and then logs the one minute average), (2) the temperature, and (3) the status (indicating the mode of the instrument and the alarm status at the time the data was logged). These three pieces of data, recorded at one logging interval *LI*, are referred to as a *record*.

Periods are groups of related records and also include a time stamp (year, month, day, hour, minutes, and seconds) and the corresponding logging interval. A period is created if any of the following conditions occurs:

- the instrument power is toggled
- the date or time has changed
- the instrument is zeroed
- the logging interval changes.

Sessions are logical divisions of the data. They are used to group the records by time, calibration date, sensor information, and instrument information. An initial session is started the first time an instrument is turned on. A new session is created if any of the following conditions occurs:

- the sensor is replaced
- a calibration was performed.
- any alarm values are changed (STEL, TWA, high limit, or low limit)
- the TWA time base has changed
- The TWA value is cleared.

STELs work independently of data logging. They are not cleared when a new session is started. STEL readings can only be cleared if (1) the instrument is in clean air for fifteen minutes, or (2) the instrument is turned off.

Each session contains the following information:

- gas type
- sensor resolution
- sensor serial number
- low alarm setpoint
- high alarm setpoint
- TWA alarm setpoint
- STEL alarm setpoint
- last calibration date (year, month, and day).

Sessions (which may also contain periods and records) link the data that is retrieved from the instrument to the sensor that was installed in the instrument at the time the data is stored.

Event Log

The GasBadge Pro stores alarm events in non-volatile memory. The last 15 gas alarm events are stored with continuous-loop logging. Alarms occur if the presence of a gas concentration exceeds the low or high level threshold or if the short term exposure limit (STEL) or time weighted average (TWA) values exceed their alarm thresholds. The information stored for each event is:

- gas type
- peak exposure level (ppm or %)
- alarm duration in minutes/seconds
- relative time that alarm occurred.

Shutdown

From anywhere in Monitor Mode, pressing the Mode button for 5 seconds begins the Shutdown process. The speaker beeps once per second for 5 seconds, and the display shows “HOLD”, if the mode button is continually pressed. After 5 seconds, the display goes blank. When the mode button is disengaged, the power to the instrument is turned off.



Hold Screen

NOTE: When power is turned off, the gas type is displayed in the upper right corner of the LCD display.

Shutdown Password Screen

If there is a security code set (i.e., the value is greater than 0), and if the Always On option is enabled, holding the Mode button for 5 seconds on the Shutdown screen goes to the Shutdown Password screen. This screen looks and acts like the Security Code screen. If the user enters the correct password at this screen (by using the Up and Down Arrow buttons to change the value and pressing Enter to accept), the instrument powers off.



Shutdown Password Screen

If the user enters an incorrect password, the instrument transfers back to the Gas Monitor screen. If no value is entered, the screen will time out in 30 seconds.

Configuration Mode

Configuration modes include the following screens:

- Security Code Setting
- Zero/Calibrate Initiate
- Days Since/Until Calibration
- Initiate Print
- Low Alarm Setting
- High Alarm Setting
- TWA Alarm Setting
- TWA Interval
- STEL Alarm Setting
- Cal Gas Setting
- Clock Setting
- Calendar Setting
- Data Log Interval
- Display Setting
- Always On Option
- Confidence Beep Option
- Alarm Latching
- Zero Enable
- Calibrate Enable
- Select Days Since/Until Calibrate
- Calibrate Due Alarm On/Off
- Calibrate Due Setpoint.

These are explained in the sections that follow.

NOTE: For flowchart view of configuration mode, see pages 9 and 10.

Introduction

The configuration mode is used to change or set instrument options. Anywhere within the configuration mode (except during calibration), if no buttons are pressed for 30 seconds, the instrument returns to the Gas Monitor screen.

Pressing the Mode button while on a “non-editing” menu will exit the configuration mode and return to the Gas Monitoring screen. A “non-editing” menu does not have any blinking segments and does not allow editing of options. Button presses have a different function when in an “editing” menu.

In the following tables, if TCM is present, the menu is a “Top Level Configuration Menu” in which no editing occurs. Pressing the Enter button from a TCM starts the editing process. The function of the buttons is described at both levels. Tables for “editing menus” are tagged with EDM.

NOTE: All timeouts are set to 30 seconds.

Security Code

The Security Code Screen is the first screen in the configuration mode which is outside of the normal operating mode. The configuration mode is reached from the countdown screen by pressing the Up and Down Arrow buttons simultaneously. The default security code is 000. If the security code is set to 000, the Security Code screen is bypassed, and the Zero Initiate screen is displayed if a toxic sensor is installed or the Cal Initiate screen is displayed if an oxygen sensor is installed.



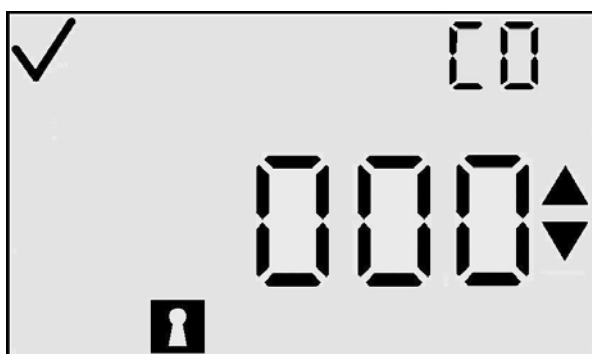

If the security code stored in the instrument is not set to 000, then the display shows “000.” The display will blink, indicating that it may be edited by the user with the Up and Down Arrow buttons. Pressing the Up Arrow button increments the security code from 000 to 999. Similarly, pressing the Down Arrow button decrements the number. When the desired code is reached, press Enter.



Enter Security Code Screen

If the correct code is entered, the instrument goes to configuration mode. If the wrong code is entered, the instrument leaves the configuration mode and returns to the monitor screen of the normal operating mode.

Actions Available from the Enter Security Code Screen

Action	Response
Mode button press 	Go to Gas Monitoring screen.
Enter button press 	If done editing the value, then go to Zero or Cal Initiate in Configuration mode if Code entered is correct. If done editing last digit, then go to Gas Monitoring Screen if Code entered is incorrect.
Up Arrow button press 	Increment value on display.
Down Arrow button press 	Decrement value on display.
30 second timeout 	Go to Gas Monitoring screen.

Calibration

For information on calibration, refer to the Calibration section on page 17.

Days Since Calibration

For information on viewing the Days Since Calibration screen, refer to the Days Since Calibration section on page 13.

Days Until Calibration

For information on viewing the Days Until Calibration screen, refer to the Days Until Calibration section on page 14.

Initiate Print





The Initiate Print screen is exactly the same as in the monitoring state with one exception – the Print indicator is active. The primary character display indicates concentration in PPM, concentration in percent volume, or gas type only depending on the display mode and all other indicators are the same for that particular display mode.



Initiate Print Screen

While data is transmitted from the instrument, the Print icon blinks. As the printer is a local device, successful operation will be readily apparent to the instrument user, so no success or failure indication is provided by the instrument.

Actions Available from the Initiate Print Screen (TCM)

Action	Response
Mode button press 	Go to Gas Monitoring screen.
Up Arrow button press 	Go to Low Alarm Setpoint screen.
Down Arrow button press 	Go to Days Since/Until Calibration (depends on value of View Next/Last Cal Date option).
30 second timeout 	Go to Gas Monitoring screen.

Low Alarm Setpoint

The Low Alarm Setpoint screen is used to set the threshold for the low alarm. For an oxygen sensor, this threshold indicates the depletion oxygen concentration at which the alarm is activated.

On entering this state, the primary character display shows the present threshold value. To edit the threshold press the Enter button.







Low Alarm Setpoint Screen

Editing a Value: All characters of the primary display blink to indicate that they are ready to change. The threshold is incremented by pressing the Up Arrow button and decremented by pressing the Down Arrow button. Simple momentary presses increment the value by 1 unit. Holding either button for an extended time increments/decrements the value much faster. Upon reaching the maximum value (which is sensor dependent), the display rolls over to the minimum value of 1. Scrolling down below the minimum value rolls over to the maximum. Pressing the Mode button aborts the editing process and takes the user back to the top-level configuration menu (TCM).

Actions Available from the Low Alarm Setpoint Screen (TCM)

Action		Response
Mode button press		Go to Gas Monitoring screen.
Enter button press		Blink value. See the edit options table.
Up Arrow button press		Go to High Alarm Setpoint screen.
Down Arrow button press		Go to IR Print screen.
30 second timeout		Go to Gas Monitoring screen.

Edit Mode Options for the Low Alarm Setpoint Screen

Action	Response
Mode button press 	Cancel changes, stop blinking value, go to TCM.
Enter button press 	Save changes, stop blinking value, go to TCM.
Up Arrow button press 	Increment value on display.
Down Arrow button press 	Decrement value on display.

Low-level and high-level alarms have a setpoint stored in the GasBadge Pro. The calibration gas concentration setpoint is also stored in the instrument.

Default Setpoints for GasBadge Pro Sensors

Sensor	Low Alarm Setpoint	High Alarm Setpoint	TWA Alarm Setpoint	STEL Alarm Setpoint	Cal Gas Concentration Setpoint	Units
CO	35	70	35	400	100	ppm
H ₂ S	10	20	10	15	25	ppm
O ₂	19.5	23.5	n/a	n/a	20.9	% vol.
NO ₂	3	6	1	5	5	ppm
SO ₂	2	4	2	10	5	ppm
NH ₃	25	50	25	35	50	ppm
Cl ₂	0.5	1.0	0.5	1.0	10	ppm
ClO ₂	0.1	0.2	0.1	0.3	1.0	ppm
PH ₃	0.3	0.6	0.3	1	1.0	ppm
HCN	5	10	4	4.7	10	ppm
H ₂	50	100	1,000	1,000	100	ppm

High Alarm Setpoint





The High Alarm Setpoint screen is used to set the threshold for the high alarm. For an Oxygen sensor, this threshold indicates the enrichment oxygen concentration at which the alarm is activated.

On entering this state, the primary character display shows the present threshold value. To edit the threshold press the Enter button.







High Alarm Setpoint Screen

Actions Available from the High Alarm Setpoint Screen (TCM)

Action	Response
Mode button press 	Go to Gas Monitoring screen.
Enter button press 	Blink value. See the edit options table.
Up Arrow button press 	Go to TWA Alarm Setpoint screen.
Down Arrow button press 	Go to Low Alarm Setpoint screen.
30 second timeout 	Go to Gas Monitoring screen.

Editing a Value: All characters of the primary display blink to indicate that they are ready to change. The threshold is incremented by pressing the Up Arrow button and is decremented by pressing the Down Arrow button. Simple momentary presses increment/decrement the value by 1 unit. Holding either button for an extended time increments/decrements the value much faster. Upon reaching the maximum value (which is sensor dependent), the display rolls over to the minimum value of 1. Scrolling down below the minimum value rolls over to the maximum. Pressing the Mode button aborts the editing process and takes the user to the top-level configuration menu (TCM).

Edit Mode Options for the High Alarm Setpoint Screen

Action		Response
Mode button press		Cancel changes, stop blinking value, go to TCM.
Enter button press		Save changes, stop blinking value, go to TCM.
Up Arrow button press		Increment value on display.
Down Arrow button press		Decrement value on display.



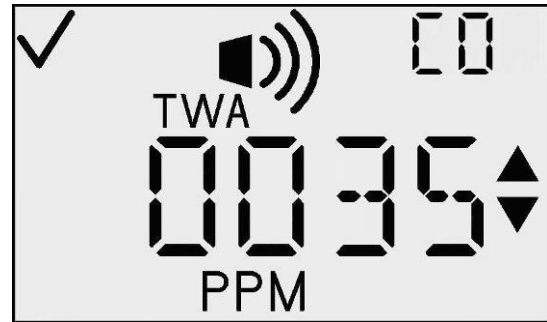

TWA Alarm Setpoint

The TWA Alarm Setpoint screen is used to set the threshold for the TWA Alarm. For a toxic sensor, this threshold indicates the average gas concentration over the TWA time base, at which the alarm is activated. For an oxygen sensor, the TWA is not used and this menu is not available.



TWA Alarm Setpoint Setup

Actions Available from the TWA Alarm Setpoint Screen (TCM)





Action		Response
Mode button press		Go to Gas Monitoring screen.
Enter button press		Blink value. See the edit options table.
Up Arrow button press		Go to Set TWA Interval screen.
Down Arrow button press		Go to High Alarm Setpoint screen.
30 second timeout		Go to Gas Monitoring screen.

GasBadge® Pro Personal Single Gas Monitor

On entering this state, the primary character display shows the present threshold value. To edit the threshold value, press the Enter button.

Editing a Value: All characters of the primary display blink to indicate that they are ready to change. The threshold is incremented by pressing the Up Arrow button and is decremented by pressing the Down Arrow button. Simple momentary presses increment/decrement the value by 1 unit. Holding either button for an extended time increments/decrements the value much faster. Upon reaching the maximum value (which is sensor dependent), the display rolls over to the minimum value of 1. Scrolling down below the minimum value rolls over to the maximum. Pressing the Mode button aborts the editing process and takes the user to the top-level configuration menu (TCM).

Edit Mode Options for the TWA Alarm Setpoint Screen

Action		Response
Mode button press		Cancel changes, stop blinking value, go to TCM.
Enter button press		Save changes, stop blinking value, go to TCM.
Up Arrow button press		Increment value on display.
Down Arrow button press		Decrement value on display.

Set TWA Interval



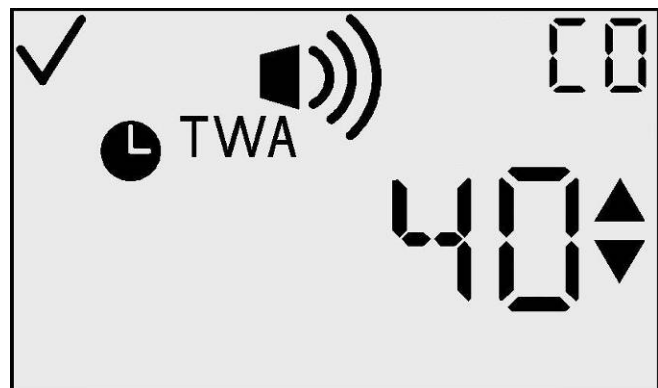

This screen allows the user to set the TWA time interval, from 1 to 40 hours. For an oxygen sensor, the time is not used and this menu is not available.

On entering this state, the primary character display shows the present TWA time-base value. To edit this value, press the Enter button.



TWA Time-base Setup Screen



Actions Available from the Set TWA Interval Screen (TCM)

Action	Response
Mode button press 	Go to Gas Monitoring screen.
Enter button press 	Blink value. See the edit options table.
Up Arrow button press 	Go to STEL Alarm Setpoint screen.
Down Arrow button press 	Go to TWA Alarm Setpoint screen.
30 second timeout 	Go to Gas Monitoring screen.

Editing a Value: All characters of the primary display blink to indicate that they are ready to change. The threshold is incremented by pressing the Up Arrow button and is decremented by pressing the Down Arrow button. Simple momentary presses increment/decrement the value by 1 unit. Holding either button for an extended time increments/decrements the value much faster. Upon reaching the maximum value (40), the display rolls over to the minimum value of 1. Scrolling down below the minimum value rolls over to the maximum. Pressing the Mode button aborts editing process and takes the user to the TCM.

NOTE: The maximum display value for all sensors is 40.

Edit Mode Options for the Set TWA Interval Screen

Action	Response
Mode button press 	Cancel changes, stop blinking value, go to TCM.
Enter button press 	Save changes, stop blinking value, go to TCM.
Up Arrow button press 	Increment value on display.

Down Arrow button press		Decrement value on display.
-------------------------	---	-----------------------------

STEL Alarm Setpoint





The STEL Alarm Setpoint screen is used to set the threshold for the STEL alarm. For a toxic sensor, this threshold indicates the gas concentration at which an alarm is activated. For an Oxygen sensor, the STEL is not used and this menu is not available.

On entering this state, the primary character display shows the present threshold value. To edit this threshold value, press the Enter button.







STEL Alarm Setpoint Setup

Actions Available from the STEL Alarm Setpoint Screen (TCM)

Action		Response
Mode button press		Go to Gas Monitoring screen.
Enter button press		Blink value. See the edit options table.
Up Arrow button press		Go to Cal Gas Setup screen.
Down Arrow button press		Go to TWA Interval screen.
30 second timeout		Go to Gas Monitoring screen.

Editing a Value: All characters of the primary display blink to indicate that they are ready to change. The threshold is incremented by pressing the Up Arrow button and is decremented by pressing the Down Arrow button. Simple momentary presses increment/decrement the value by 1 unit. Holding either button for an extended time increments/decrements the value much faster. Upon reaching the maximum value (which is sensor dependent), the display rolls over to the minimum value of 1. Scrolling down below the minimum rolls over to the maximum. Pressing the Mode button aborts the editing process and takes the user to the TCM.

Edit Mode Options for the STEL Alarm Setpoint Screen

Action	Response
Mode button press 	Cancel changes, stop blinking value, go to TCM.
Enter button press 	Save changes, stop blinking value, go to TCM.
Up Arrow button press 	Increment value on display.
Down Arrow button press 	Decrement value on display.



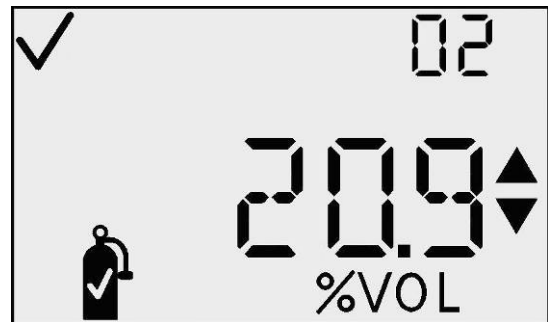
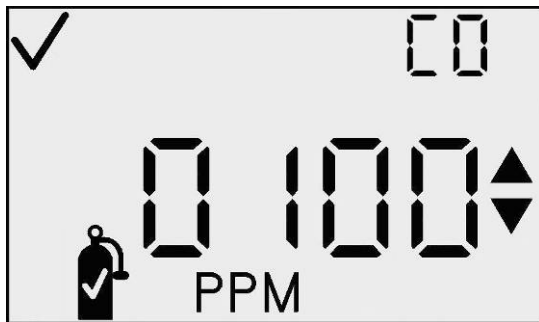

Set Calibration Gas Concentration

This screen allows the user to set the calibration gas concentration. On entering this state, the primary character display shows the present calibration gas value. To edit the calibration gas value, press the Enter button.





Cal Gas Concentration PPM and %Vol Setup Screens

Actions Available from the Set Cal Gas Concentration Screen (TCM)

Action	Response
Mode button press 	Go to Gas Monitoring screen.
Enter button press 	Blink value. See the edit options table.
Up Arrow button press 	Go to Set Clock screen.
Down Arrow button press 	For toxic sensors, go to STEL Alarm Setpoint screen. For O ₂ sensors, go to High Alarm Setpoint screen.
30 second timeout 	Go to Gas Monitoring screen.

Editing a Value: All characters of the primary display blink to indicate that they are ready to change. The threshold is incremented by pressing the Up Arrow button and is decremented by pressing the Down Arrow button. Simple momentary presses increment/decrement the value by 1 unit. Holding either button for an extended time increments/decrements the value much faster. Upon reaching the maximum value (which is sensor dependent), the display rolls over to the minimum value of 1 (0.1 for some sensors). Scrolling down below the minimum value rolls over to the maximum. Pressing the Mode button aborts the editing process and takes the user to the TCM.

Edit Mode Options for the Set Cal Gas Concentration Screen

Action	Response
Mode button press 	Cancel changes, stop blinking value, go to TCM.
Enter button press 	Save changes, stop blinking value, go to TCM.
Up Arrow button press 	Increment value on display.

Down Arrow button press		Decrement value on display.
-------------------------	---	-----------------------------



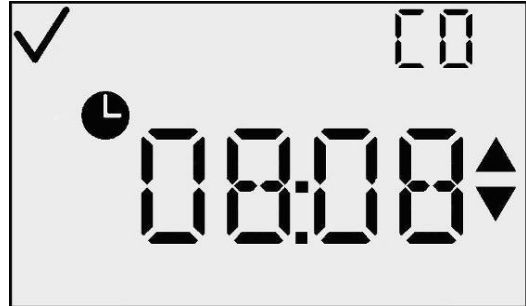

Set Clock

This screen allows the user to set the current time, in 24-hour format. On entering this state, the primary character display shows the present hours and minutes. To start editing, press the Enter button which causes the hours value to blink.







Set Clock Screen (TCM)

Actions Available from the Set Clock Screen (TCM)

Action		Response
Mode button press		Go to Gas Monitoring screen.
Enter button press		Blink value. See the edit hours options table.
Up Arrow button press		Go to Set Calendar screen.
Down Arrow button press		Go to Set Calibration Gas Concentration screen.
30 second timeout		Go to Gas Monitoring screen.





Editing a Value – Hours: The hours value blinks to indicate that it is the value to be edited. The hours value is incremented by pressing the Up Arrow button and decremented by pressing the Down Arrow button. Simple momentary presses increment/decrement the value by 1 unit. Holding either button for an extended time increments/decrements the value much faster. Upon reaching the maximum value (23), the display rolls over to the minimum value of 1. Scrolling down below the minimum rolls over to the maximum. Press the Enter button to accept the hours value and edit the minutes value.

Edit Mode Options (Hours) for the Set Clock Screen

Action		Response
Mode button press		Cancel changes, stop blinking value, go to TCM
Enter button press		Save hours changes, stop blinking hours, blink minutes, and go to the edit minutes table
Up Arrow button press		Increment value on display
Down Arrow button press		Decrement value on display

Editing a Value - Minutes: The minute value blinks to indicate that it is the value to be edited. The minute value is incremented by pressing the Up Arrow button and is decremented by pressing the Down Arrow button. Simple momentary presses increment/decrement the value by 1 unit. Holding either button for an extended time increments/decrements the value much faster. Upon reaching the maximum value (59), the display rolls over to the minimum value of 0. Scrolling down below the minimum rolls over to the maximum value. Press the Enter button to accept the minute value and return to the TCM.

Edit Mode Options (Minutes) for the Set Clock Screen

Action		Response
Mode button press		Cancel changes, stop blinking value, go to TCM.
Enter button press		Save minutes, stop blinking minutes, and go to TCM.
Up Arrow button press		Increment value on display.
Down Arrow button press		Decrement value on display.

Set Calendar Month/Day

This screen allows the user to set the month, day, and year. On entering this state, the primary character display shows the present month and day, and also shows the check mark and month icons. To start editing press the Enter button which causes the month value to blink.

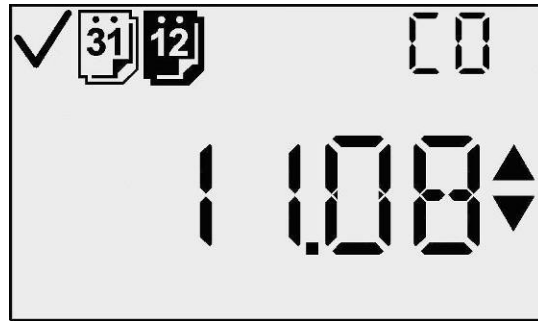

Set Calendar (Month and Date) Screen

Actions Available from the Set Calendar Month/Day Screen (TCM)

Action		Response
Mode button press		Go to Gas Monitoring screen.
Enter button press		Blink month value. See the edit month options table.
Up Arrow button press		Go to Set Security Code screen.
Down Arrow button press		Go to Set Clock screen.
30 second timeout		Go to Gas Monitoring screen.



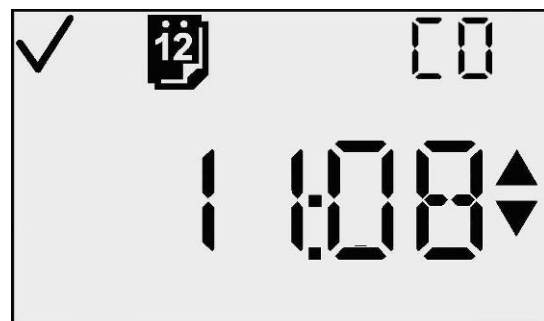

Editing a Value - Month: The month value blinks to indicate that it is the value to be edited. The month value is incremented by pressing the Up Arrow button and is decremented by pressing the Down Arrow button. Simple momentary presses increment/decrement the value by 1 unit. Holding either button for an extended time increments/decrements the value much faster.



Set Calendar Month Screen

Upon reaching the maximum value (12), the display rolls over to the minimum value of 1. Scrolling down below the minimum rolls over to the maximum. Press the Enter button to accept the month value and edit the day value.

Edit Mode Options (Month) for the Set Calendar Month/Day Screen

Action	Response
Mode button press 	Cancel changes, stop blinking value, go to TCM.
Enter button press 	Save month, stop blinking month, blink days, remove month icon, display day icon, and go to edit day options table.
Up Arrow button press 	Increment value on display.
Down Arrow button press 	Decrement value on display.



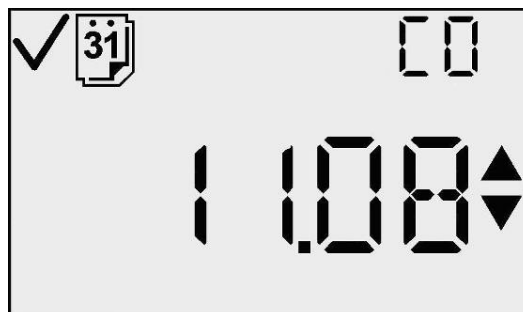

Editing a Value - Day: The day value blinks to indicate that it is the value to be edited. The day value is incremented by pressing the Up Arrow button and is decremented by pressing the Down Arrow button. Simple momentary presses increment/decrement the value by 1 unit. Holding either button for an extended time increments/decrements the value much faster.



Set Calendar Day

Upon reaching the maximum value (31), the display rolls over to the minimum value of 0. Scrolling down below the minimum value rolls over to the maximum. Press the Enter button to accept the day value and go to edit the year value.

Edit Mode Options (Day) for the Set Calendar Month/Day Screen

Action	Response
Mode button press 	Cancel changes, stop blinking value, go to TCM.
Enter button press 	Save day, show month icon, display current year, and go to edit year options table.
Up Arrow button press 	Increment value on display.
Down Arrow button press 	Decrement value on display.



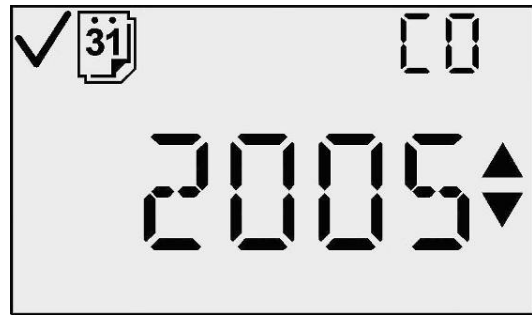

Editing a Value - Year: This screen displays the year as “20xx.” The year value blinks to indicate that it is the value to be edited. The year value is incremented by pressing the Up Arrow button and is decremented by pressing the Down Arrow button. Simple momentary presses increment/decrement the value by 1 unit. Holding either button for an extended time increments/decrements the value much faster.



Set Calendar (Year) Screen

Upon reaching the maximum value (99), the display rolls over to the minimum value of 00. Scrolling down below the minimum value rolls over to the maximum. Press the Enter button to accept the year value and go to the TCM.

Edit Mode Options (Year) for the Set Calendar Month/Day Screen

Action	Response
Mode button press 	Cancel changes, stop blinking value, go to TCM.
Enter button press 	Save day, show month icon, display current year, and go to TCM.
Up Arrow button press 	Increment value on display.
Down Arrow button press 	Decrement value on display.



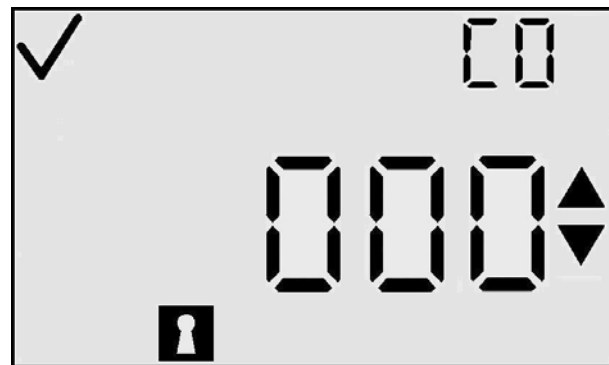

Set Security Code

This screen allows the user to set the security code. On entering this state, the primary character display shows the present security code. The Up, Down, Check, and Lock indicators are active. To edit the security code, press the Enter button.



Set Security Code Screen





Actions Available from the Set Security Code Screen (TCM)

Action	Response
Mode button press 	Go to Gas Monitoring screen.
Enter button press 	Blink value. See the edit options table. (Default value is 000.)
Up Arrow button press 	Go to Set Datalog Interval screen.
Down Arrow button press 	Go to Set Calendar screen.
30 second timeout 	Go to Gas Monitoring screen.

Editing a Value: Upon pressing the Enter button, the first digit of the code blinks, indicating that it may be edited by the user with the Up and Down Arrow buttons. The code is incremented by pressing the Up Arrow button and is decremented by pressing the Down Arrow button. Simple momentary presses increment/decrement the value by 1 unit. Holding either button for an extended time increments/decrements the value much faster. Upon reaching the maximum value (999), the display rolls over to the minimum value of 000. Scrolling down below the minimum value rolls over to the maximum.

After the user reaches the desired value, pressing the Enter button sets the code and returns to the TCM. While editing the value, pressing Mode cancels the operation and returns to the TCM.

Edit Mode Options for the Set Security Code Screen

Action	Response
Mode button press 	Cancel changes, stop blinking value, go to TCM.
Enter button press 	Accept current value and go to TCM.
Up Arrow button press 	Increment value on display.
Down Arrow button press 	Decrement value on display.

Set Data Log Interval

This screen allows the user to set the datalog interval, from 2 to 300 seconds (in 2 second increments). On entering this state, the primary character display shows the current logging interval in seconds, the check, the time, and the logging icon. To edit the logging interval, press the Enter button.

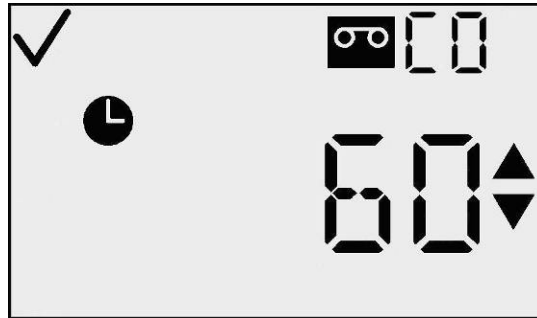





Set Datalog Interval Screen

Actions Available from the Set Data Log Interval Screen (TCM)

Action		Response
Mode button press		Go to Gas Monitoring screen
Enter button press		Blink value. See the edit options table. (Default is 60 seconds.)
Up Arrow button press		Go to Primary Display Setup screen
Down Arrow button press		Go to Set Security Code screen
30 second timeout		Go to Gas Monitoring screen

Editing a Value: All characters of the primary display blink to indicate that they are ready to change. The interval is incremented by pressing the Up Arrow button and is decremented by pressing the Down Arrow button. Simple momentary presses increment/decrement the value by 1 unit. Holding either button for an extended time increments/decrements the value much faster. Upon reaching the maximum value (300 seconds), the display rolls over to the minimum value of 2 (seconds). Scrolling down below this minimum value causes the display to roll over to the maximum. Pressing the Mode button aborts the editing process and takes the user to the TCM.

Edit Mode Options for the Set Data Log Interval Screen

Action	Response
Mode button press 	Cancel changes, stop blinking value, go to TCM.
Enter button press 	Save changes, stop blinking value, and go to TCM.
Up Arrow button press 	Increment value on display.
Down Arrow button press 	Decrement value on display.

Primary Display Setting

This screen allows the user to select the primary display type. The primary display, while in monitor mode, can either be Monitor Gas Readings Only (PPM/Percentage Volume) or Monitor Gas Type Only.

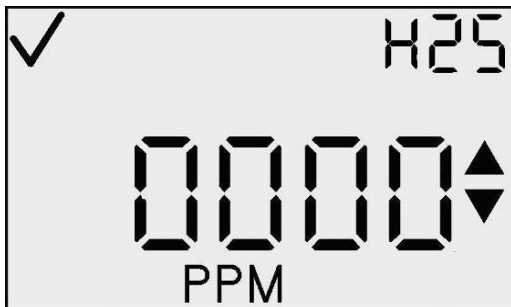





Monitor Gas Readings Only Setting



Monitor Gas Type Only Setting





On entering this state, the screen will show the current display setup along with the Check Mark icon. To edit the display type press the Enter button.

Actions Available from the Primary Display Setting Screen (TCM)

Action	Response
Mode button press 	Go to Gas Monitoring screen.
Enter button press 	Blink value. See the edit options table. (Default is Monitor PPM/% Vol.)
Up Arrow button press 	Go to Always On Option screen.
Down Arrow button press 	Go to Logging Interval screen.
30 second timeout 	Go to Gas Monitoring screen.

Editing a Value: All characters of the primary display and auxiliary display blink to indicate that they are ready to be changed. Simple momentary presses change the display type. Pressing the Mode button aborts the editing process and takes the user to the TCM. Pressing the Enter button saves the display type and takes the user to the TCM.

Edit Mode Options for the Primary Display Setting Screen

Action	Response
Mode button press 	Cancel changes, stop blinking value, go to TCM.
Enter button press 	Save changes, stop blinking value, and go to TCM.
Up Arrow button press 	Change display type.
Down Arrow button press 	Change display type.

Always On Option

The Set Always On screen is used to disable turning off of the instrument. The rightmost character of the primary display shows either a “0” or a “1.” A value of “0” indicates that the instrument can be powered off by the user and a value of “1” indicates that the user CANNOT turn off the instrument.

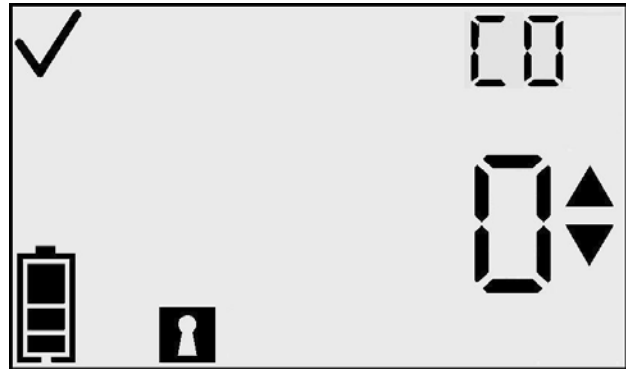

Always On Option





When this option is on, the only times the user can turn off the instrument are during the following conditions:

- zero fail
- cal fail
- missing sensor alarm
- system alarm.

On entering this state, the screen shows the current setup along with the check icon. To edit the display type, press the Enter button.





NOTE: A security code other than 000 must be set for this feature to be active.

Actions Available from the Always On Option Screen

Action		Response
Mode button press		Go to Gas Monitoring screen.
Enter button press		Blink value. See the edit options table. (Default is “0” = Always On Option is OFF.)
Up Arrow button press		Go to Set Confidence Indicator screen.
Down Arrow button press		Go to Primary Display Setup screen.
30 second timeout		Go to Gas Monitoring screen.

Editing a Value: All characters of the primary display blink to indicate that they are ready to change. Simple momentary presses toggle the value between “0” and “1.” Pressing the Mode button aborts the editing process and takes the user to the TCM. Pressing the Enter button saves the setting and displays the TCM.

Edit Mode Options for the Always On Option Screen

Action	Response
Mode button press 	Cancel changes, stop blinking value, go to TCM.
Enter button press 	Save changes, stop blinking value, and go to TCM.
Up Arrow button press 	Toggle option.
Down Arrow button press 	Toggle option.

Set Confidence Indicator

The Set Confidence Indicator screen is used to enable the confidence indicator during monitoring in normal instrument operation. The left most character of the primary character display shows the letter “C” to indicate that this is the confidence mode setup. The rightmost character of the primary display shows either a “0” or a “1.” A value of “0” indicates that the confidence indicator “beep” is to be disabled.

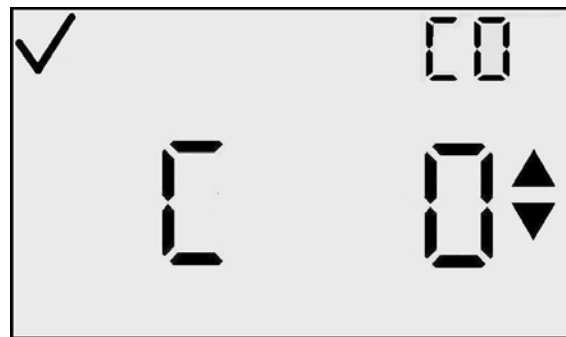





Set Confidence Indication

A value of “1” indicates that the confidence indicator “beep” is to be enabled. To edit this option, press the Enter button.





NOTE: When the confidence indicator is enabled, the instrument beeps and flashes every 30 seconds to alert the user it is still operating.

Actions Available from the Set Confidence Indicator Screen

Action	Response
Mode button press 	Go to Gas Monitoring screen.
Enter button press 	Blink value. See the edit options table. (Default is “0” = Indicator disabled.)
Up Arrow button press 	Go to Alarm Latch Setup screen.
Down Arrow button press 	Go to Always On Option screen.
30 second timeout 	Go to Gas Monitoring screen.

Edit a Value: All characters of the primary display blink to indicate that they are ready to be changed. Simple momentary presses toggle the value between “0” and “1.” Pressing the Mode button aborts the editing process and takes the user to the TCM. Pressing the Enter button saves the setting and displays the TCM.

Edit Mode Options for the Set Confidence Indicator Screen

Action	Response
Mode button press 	Cancel changes, stop blinking value, go to TCM.
Enter button press 	Save changes, stop blinking value, and go to TCM.
Up Arrow button press 	Toggle option.
Down Arrow button press 	Toggle option.



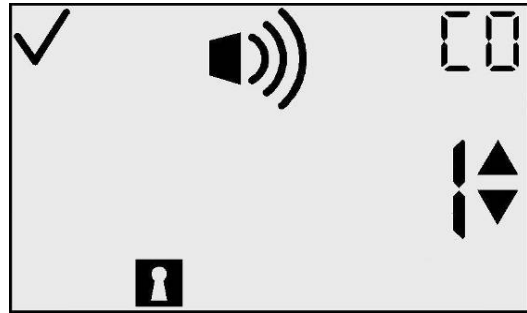

Alarm Latch Setup

The Alarm Latch Setup screen is used to toggle the user option of alarm latching. When alarms are latched (1), any gas alarm continues to be indicated to the user, even after the gas concentration subsides. This continues until the user acknowledges the alarm by pressing the Enter button from the Gas Monitoring screen. Only High and Low gas alarms are latched (STEL and TWA alarms are not).







Alarm Latch Setup

Actions Available from the Alarm Latch Setup Screen

Action		Response
Mode button press		Go to Gas Monitoring screen.
Enter button press		Blink value. See the edit options table. (Default is "0" = Alarms not latched.)
Up Arrow button press		Go to Zero Lock Options screen (for toxic sensors) or Cal Lock Option screen (for O ₂).
Down Arrow button press		Go to Set Confidence Indication screen.
30 second timeout		Go to Gas Monitoring screen.

Edit Mode Options for the Alarm Latch Setup Screen

Action		Response
Mode button press		Cancel changes, stop blinking value, go to TCM.
Enter button press		Save changes, stop blinking value, and go to TCM.
Up Arrow button press		Toggle option.
Down Arrow button press		Toggle option.

Zero In Field Option

This screen allows the user to enable/disable the Zero In Field feature (to lock out zeroing) in monitor mode. The default for this option is NO or “0.” If set to “0” then zeroing is not locked and the zero initiate menu is available to the user in monitoring mode. For toxic sensors, if the Zeroing In Field is turned off, the Cal In Field option is automatically turned off.

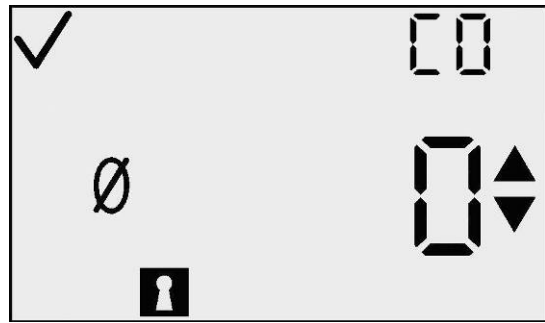







Figure 2- Zero Lock Option

To edit the option press the Enter button.





NOTE: If the zero lockout feature is enabled, the calibration lockout feature is also enabled.

Actions Available from the Zero In Field Option Screen (TCM)

Action	Response
Mode button press 	Go to Gas Monitoring screen.
Enter button press 	Blink value. See the edit options table. (Default is “0” = Zero is not locked.)
Up Arrow button press 	Go to Cal Lock Options screen if Zero Lock Option is off, or Cal Date View Option Screen if on.
Down Arrow button press 	Go to Alarm Latch screen.
30 second timeout 	Go to Gas Monitoring screen.

Editing a Value: All characters of the primary display blink to indicate that they are ready to be changed. Simple momentary presses of the Up or Down Arrow button toggle the value between “0” and “1.” Pressing the Mode button aborts the editing process and takes the user to the TCM. Pressing the Enter button saves the setting and displays the TCM.

Edit Mode Options for the Zero Lock Screen

Action		Response
Mode button press		Cancel changes, stop blinking value, go to TCM.
Enter button press		Save changes, stop blinking value, and go to TCM.
Up Arrow button press		Toggle option.
Down Arrow button press		Toggle option.



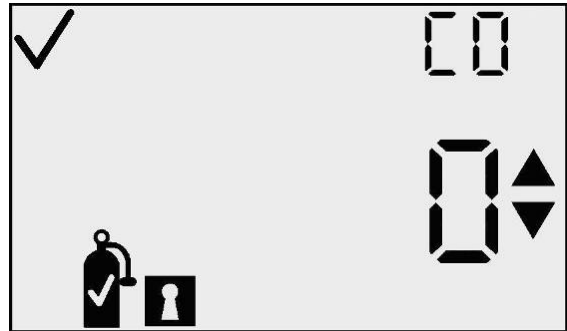

Cal In Field Option

This screen allows the user to select whether or not to lock out calibration in monitor mode, i.e., it enables/disables the ability to Calibrate in the field. The default for this option is NO or “0.” For a value of “0”, calibration is not locked and the Cal Initiate menu is available in monitoring mode. This menu cannot be viewed if the Zero Lock option is on for toxic sensors. To edit this option, press the Enter button.



Cal Lock Option Screen





Actions Available from the Cal In Field Option Screen

Action		Response
Mode button press		Go to Gas Monitoring screen.
Enter button press		Blink value. See the edit options table. (Default is “0” = Span is not locked.)
Up Arrow button press		Go to Cal Date View Option screen.
Down Arrow button press		Go to Zero Lock Option screen. For O ₂ units, go to Alarm Latch screen.

30 second timeout		Go to Gas Monitoring screen.
-------------------	---	------------------------------

Editing a Value: All characters of the primary display blink to indicate that they are ready to be changed. Simple momentary presses of the Up or Down Arrow button toggle the value between “0” and “1.” Pressing the Mode button aborts the editing process and takes the user to the TCM. Pressing the Enter button saves the setting and displays the TCM.

Edit Mode Options for the Cal In Field Option Screen

Action		Response
Mode button press		Cancel changes, stop blinking value, go to TCM.
Enter button press		Save changes, stop blinking value, and go to TCM.
Up Arrow button press		Toggle option.
Down Arrow button press		Toggle option.



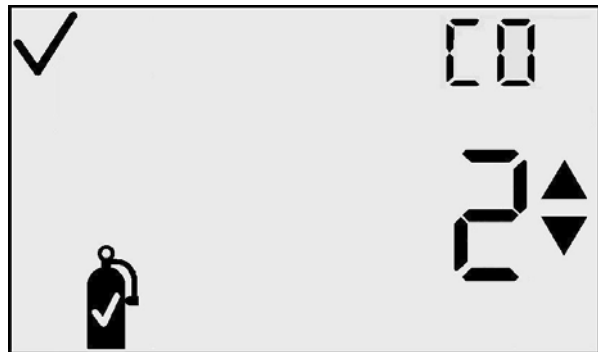

Cal Date View Option Screen

This screen allows the user to choose the calibration date to be viewed in the main menu loop and during warmup, if any. A value of “0” indicates that neither cal date is displayed. A value of “1” indicates that “the number of days since the previous calibration” is displayed. A value of “2” indicates that “the number of days until the next calibration is due” is displayed. The default value for this option is “0.”







Cal Date View Option Screen

Actions Available from the Cal Date View Option Screen

Action	Response
Mode button press 	Go to Gas Monitoring screen.
Enter button press 	Blink value. See the edit options table.
Up Arrow button press 	Go to Calibration Past Due Alarm screen.
Down Arrow button press 	Go to Cal Lock Option screen if Zero Lock option is off, or Cal Date View option if on.
30 second timeout 	Go to Gas Monitoring screen.

Edit Mode Options for the Cal Date View Option Screen

Action	Response
Mode button press 	Cancel changes, stop blinking value, go to TCM.
Enter button press 	Save changes, stop blinking value, and go to TCM.
Up Arrow button press 	Toggle option.
Down Arrow button press 	Toggle option.

Calibration Past Due Alarm

This screen allows the user to turn on or off a “calibration past due” alarm. This alarm is active in the Gas Monitoring mode. When the calibration is past due, the cal bottle icon flashes and the instrument beeps every 5 seconds. The default setting is OFF or “0.”

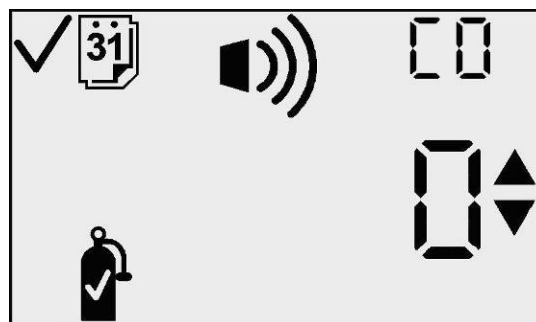





Cal Due Alarm Option

Actions Available from the Calibration Past Due Alarm Screen (TCM)

Action		Response
Mode button press		Go to Gas Monitoring screen.
Enter button press		Blink value. See the edit options table. (Default is “0” = Cal Due Alarm is OFF.)
Up Arrow button press		Go to Cal Due Setpoint screen.
Down Arrow button press		Go to Cal Date View Option screen.
30 second timeout		Go to Gas Monitoring screen.

Editing a Value: All characters of the primary display blink to indicate that they are ready to be changed. Simple momentary presses of the Up or Down Arrow button toggle the value between “0” and “1.” Pressing the Mode button aborts the editing process and takes the user to the TCM. Pressing the Enter button saves the setting and displays the TCM.

Edit Mode Options for the Calibration Past Due Alarm Screen

Action		Response
Mode button press		Cancel changes, stop blinking value, go to TCM.
Enter button press		Save changes, stop blinking value, and go to TCM.
Up Arrow button press		Toggle option.
Down Arrow button press		Toggle option.

Calibration Due Setpoint



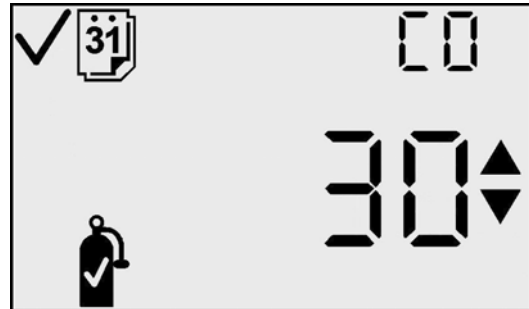

This screen allows the user to set the number of days until the next calibration. The factory default is 30 days. The range is from 1 to 365 days. This is the setpoint that is used for the calibration due alarm. On entering this state, the primary character display shows the current threshold value, the Calibration Gas Bottle, the Alarm icon, the Check icon, and the Day icon.



Calibration Due Setpoint Screen





To edit the threshold, press the Enter button.

Actions Available from the Calibration Due Setpoint Screen (TCM)

Action		Response
Mode button press		Go to Gas Monitoring screen.
Enter button press		Blink value. See the edit options table.
Up Arrow button press		Go to Zero or Cal Initiate screen.
Down Arrow button press		Go to Cal Due Alarm screen.
30 second timeout		Go to Gas Monitoring screen.

Editing a Value: The threshold value on the primary display blinks to indicate that it is ready to be changed. The threshold is incremented by pressing the Up Arrow button and is decremented by pressing the Down Arrow button. Simple momentary presses increment/decrement the value by 1 unit. Holding either button for an extended time increments/decrements the value much faster. Upon reaching the maximum value (365), the display rolls over to the minimum value of 1. Scrolling down below the minimum value rolls over to the maximum. Pressing the Mode button aborts the editing process and takes the user to the TCM.

Edit Mode Options for the Calibration Due Setpoint Screen

Action	Response
Mode button press 	Cancel changes, stop blinking value, go to TCM.
Enter button press 	Save changes, stop blinking value, and go to TCM.
Up Arrow button press 	Increment value on display.
Down Arrow button press 	Decrement value on display.





Bump in Field Option

This screen allows the user to enable the option to perform a bump test in the field. The default setting on this option is 0. When this screen is set to 1, it will allow the “bump” screen to be seen in the normal operating mode. Setting this screen to 1 will also enable further configuration options for enabling the bump due alarm, the bump test interval, and the bump test duration.







Actions Available from the Bump in Field screen(TCM)

Action	Response
Mode button press 	Go to Gas Monitoring screen.

Enter button press		Blink value. See the edit options table. (Default is “0” = Bump in Field disabled)
Up Arrow button press		If value = 0, Go to Zero/Calibrate initiate screen. If value = 1, Go to Bump Overdue Alarm screen
Down Arrow button press		Go to Calibration Date Setpoint screen.
30 second timeout		Go to Gas Monitoring screen.

Editing a Value: The value on the primary display blinks to indicate that it is ready to be changed. Simple momentary presses of the Up or Down Arrow button toggle the value between “0” and “1.” Pressing the Mode button aborts the editing process and takes the user to the TCM. Pressing the Enter button saves the setting and displays the TCM.

Edit Mode Options for the Calibration Due Setpoint Screen



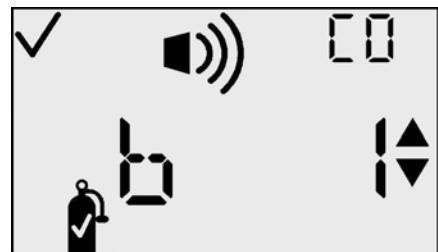

Action		Response
Mode button press		Cancel changes, stop blinking value, go to TCM.
Enter button press		Save changes, stop blinking value, and go to TCM.
Up Arrow button press		Toggles value from 0 to 1 or 1 to 0.
Down Arrow button press		Toggles value from 0 to 1 or 1 to 0.

Bump Overdue Alarm Enable

If the bump test option has been enabled, this screen allows the user to enable an alarm that indicates when the instrument is overdue for bump testing. If the bump overdue alarm is enabled, the user will be notified by the appearance of the flashing bump test screen and an audible chirp every 30 seconds.







Actions Available from the Bump Overdue Alarm Screen (TCM)

Action	Response
Mode button press 	Go to Gas Monitoring screen.
Enter button press 	Blink value. See the edit options table. (Default is “0” = Bump Overdue Alarm disabled)
Up Arrow button press 	Go to Bump Test Interval screen
Down Arrow button press 	Go to Bump Test Enable screen.
30 second timeout 	Go to Gas Monitoring screen.

Editing a Value: The value on the primary display blinks to indicate that it is ready to be changed. Simple momentary presses of the Up or Down Arrow button toggle the value between “0” and “1.” Pressing the Mode button aborts the editing process and takes the user to the TCM. Pressing the Enter button saves the setting and displays the TCM.

Edit Mode Options for the Bump Overdue Alarm Screen

Action	Response
Mode button press 	Cancel changes, stop blinking value, go to TCM.
Enter button press 	Save changes, stop blinking value, and go to TCM.
Up Arrow button press 	Toggles value from 0 to 1 or 1 to 0.
Down Arrow button press 	Toggles value from 0 to 1 or 1 to 0.

Bump Test Interval

At this screen, the user has the option to set the desired frequency of the bump test before the overdue alarm is activated. This default value is one day and may be set in ½ day increments from ½ day up to 7 days. This will allow the user to ensure that instruments are bump tested twice daily or before two shifts if desired. When the set value has been exceeded without a successful bump test occurring, the overdue alarm described above will be activated.

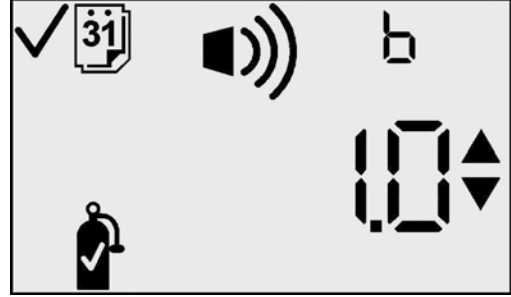

Actions Available from the Bump Test Interval Screen (TCM)



Action		Response
Mode button press		Go to Gas Monitoring screen.
Enter button press		Blink value. See the edit options table. (Default is “1.0” = Bump Test interval is one day)
Up Arrow button press		Go to Bump Test Timeout screen
Down Arrow button press		Go to Bump Test Alarm Enable screen.
30 second timeout		Go to Gas Monitoring screen.

Editing a Value: The value on the primary display blinks to indicate that it is ready to be changed. Pressing the up or down button causes the value to increment or decrement in 0.5 day intervals from 0.5 to 7.0. The default value of this screen is set to 1.0 days.

Edit Mode Options for the Bump Test Interval Screen

Action		Response
Mode button press		Cancel changes, stop blinking value, go to TCM.

GasBadge® Pro Personal Single Gas Monitor



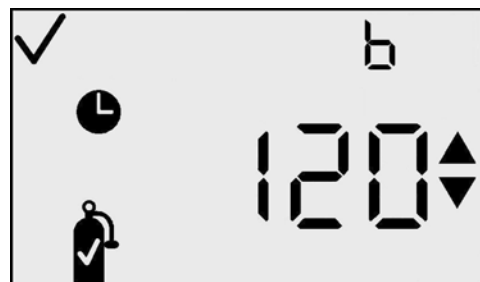

Enter button press		Save changes, stop blinking value, and go to TCM.
Up Arrow button press		Increments value in 0.5 day increments.
Down Arrow button press		Decrements the value in 0.5 day decrements.

Bump Test Timeout

This screen allows the user to set the desired length of time for the bump test to take place before failure. The default value of 45 seconds is used and indicates that the instrument will determine that the bump test has failed if a 50% response to the calibration gas concentration is not reached within 45 seconds. This value may be selected in 5 second intervals from 30 seconds to 300 seconds. The bump test period will end when the selected timeout value is reached regardless of whether the test has passed or failed.







Actions Available from the Bump Test Timeout Screen (TCM)

Action		Response
Mode button press		Go to Gas Monitoring screen.
Enter button press		Blink value. See the edit options table. (Default is “45” = Bump Test Timeout is 45seconds.)
Up Arrow button press		Go to Zero/Calibrate Initiate screen
Down Arrow button press		Go to Bump Test Interval screen.
30 second timeout		Go to Gas Monitoring screen.

Editing a Value: The value on the primary display blinks to indicate that it is ready to be changed. Pressing the up or down buttons will cause the value to increment or decrement at intervals of 5 seconds between 30 and 300 seconds.

Edit Mode Options for the Bump Test Timeout Screen

Action		Response
Mode button press		Cancel changes, stop blinking value, go to TCM.
Enter button press		Save changes, stop blinking value, and go to TCM.
Up Arrow button press		Increments value in 5 second intervals.
Down Arrow button press		Decrements value in 5 second intervals.

The DS2 Docking Station (Optional Accessory)

The DS2 Docking Station is available for the GasBadge Pro instrument. The DS2 provides the ultimate flexibility for managing your gas monitors, where ever they are used. The DS2 provides automatic calibrations, bump testing, record keeping and instrument diagnostics for your GasBadge Pro instrument. For more information on the DS2, visit www.ds2online.com.

Datalink (Optional Accessory)

The GasBadge Datalink is an accessory item that can be used to download the event log as well as the data logged memory, to a PC or to setup the instrument.

Troubleshooting and Maintenance

Diagnosing Common Problems

Problem	Likely Cause(s)
Display is blank...	<ul style="list-style-type: none">• The instrument has not been activated• No power
Unit resets (off/on)...	<ul style="list-style-type: none">• Internal error. Unit needs to be serviced.
Unit does not respond to gas...	<ul style="list-style-type: none">• Check sensor opening for dirt or debris.• Replace sensor patch.• Calibrate instrument.

Alarm Screen

In the presence of a gas concentration that exceeds the low or high level threshold, the instrument will alarm. New alarm detection in any of the instrument's normal operating screens – the battery life, peak, or initiate print screens – will force a transition back to the monitoring screen. An alarm is indicated on the display by the Alarm indicator and either the Up indicator or Down indicator which designate either high or low alarm, respectively.

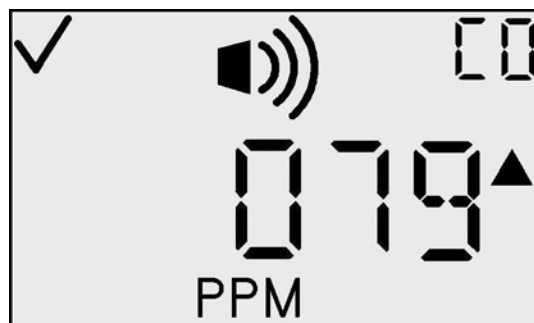

Sample High Alarm Screen

Battery Failure

Three levels of low battery warnings exist to let you know that the instrument is nearing the end of its life.

At seven days of battery life remaining, the empty outline of the battery icon appears on the Gas Monitoring screen, and blinks as a warning.

At four hours of life remaining, a low battery warning shall be presented to give you a minimum of 4 hours prior to battery failure. This is indicated by a short burst of alarms every 15 seconds, accompanied by an empty blinking Battery icon on the Battery Life Remaining screen and the Gas Monitoring screen.

With one minute of battery runtime remaining, the Battery screen appears, along with the alarm indicators, indicating that the end of the instrument's operating life is imminent. At the end of 1 minute, the instrument performs an orderly software shutdown.

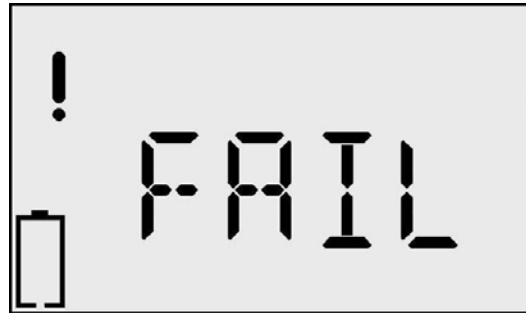

Battery Failure Screen

Sensor Missing Error

The GasBadge Pro performs a self-test without initiation from the operator. The self test occurs at intervals of 2 seconds. The self test ensures the presence of the sensor and validates that the instrument is working properly. A system exception is generated if the sensor's presence cannot be confirmed or if an error is detected.

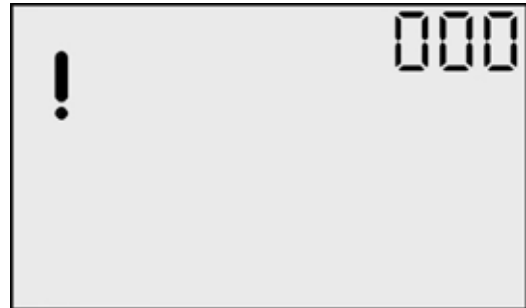

Sensor Missing Error Screen

The Missing Sensor Error screen indicates that no sensor is installed in the instrument (or, for some reason, communication with the sensor has failed). There is an alarm indication while this screen is active. Since the instrument can hold several different sensor types, the auxiliary readout, which usually displays the gas type, shows a blinking "000." Also, the exclamation point icon is active.

Unexpected Instrument Error

The Unexpected Instrument Error screen indicates that an unexpected instrument error has occurred and the instrument will reset. If the error persists, the instrument must be returned to Industrial Scientific for repair or replacement.

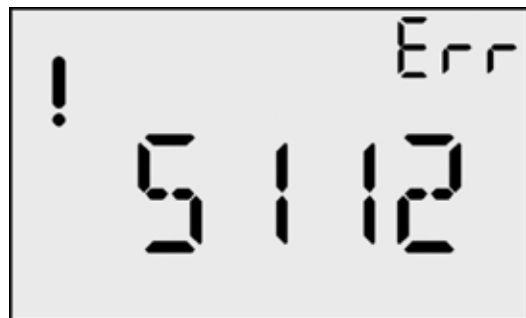

Unexpected Error Screen

Replacing Parts

The battery and water/dust sensor barriers of the GasBadge Pro may be replaced as a part of the routine maintenance schedule. These items are shown in the detailed components drawing below, with reference callouts 2 and 3, respectively. To replace the battery, you must open the instrument by unscrewing the 4 Phillips head screws located at the back of the instrument, as shown in the components drawing below. Use the illustration to locate the components. Be sure to examine the location and position of each component before replacing it. All replacement parts are summarized in the table that follows.

To replace the water/dust sensor barrier, remove the old barrier from the top of the instrument and affix the new barrier to the top of the instrument.

Replacement Part Numbers for the GasBadge Pro

Item	Part #	Description
*	17124983-1	GasBadge® Pro replacement carbon monoxide (CO) sensor
	17124983-2	GasBadge® Pro replacement hydrogen sulfide (H ₂ S) sensor
	17124983-3	GasBadge® Pro replacement oxygen (O ₂) sensor
	17124983-4	GasBadge® Pro replacement nitrogen dioxide (NO ₂) sensor
	17124983-5	GasBadge® Pro replacement sulfur dioxide (SO ₂) sensor
	17124983-6	GasBadge® Pro replacement ammonia (NH ₃) sensor
	17124983-7	GasBadge® Pro replacement chlorine (Cl ₂) sensor
	17124983-8	GasBadge® Pro replacement chlorine dioxide (ClO ₂) sensor
	17124983-9	GasBadge® Pro replacement phosphine (PH ₃) sensor
	17124983-B	GasBadge® Pro replacement hydrogen cyanide (HCN) sensor
	17124983-C	GasBadge® Pro replacement hydrogen (H ₂) sensor
	17124983-G	GasBadge® Pro CO sensor/low hydrogen interference (CO/H ₂ null)
1	17120007	Replacement PCB
2	17123019	Replacement battery
3	17126343	Replacement LCD
4	17120080	Vibrating alarm
5	17052339	Case Screws (UL, CSA, ATEX Approved units)
	17051666	Case Screws (Australia and MSHA)
6	17120528	Suspender Clip
7	17120908	Belt Clip
8	17126335	Clip attachment screw
9	17126350	PCB mounting screw
10	17124504	Replacement water/dust barriers (5 count)
11	17120635	Sensor Gasket

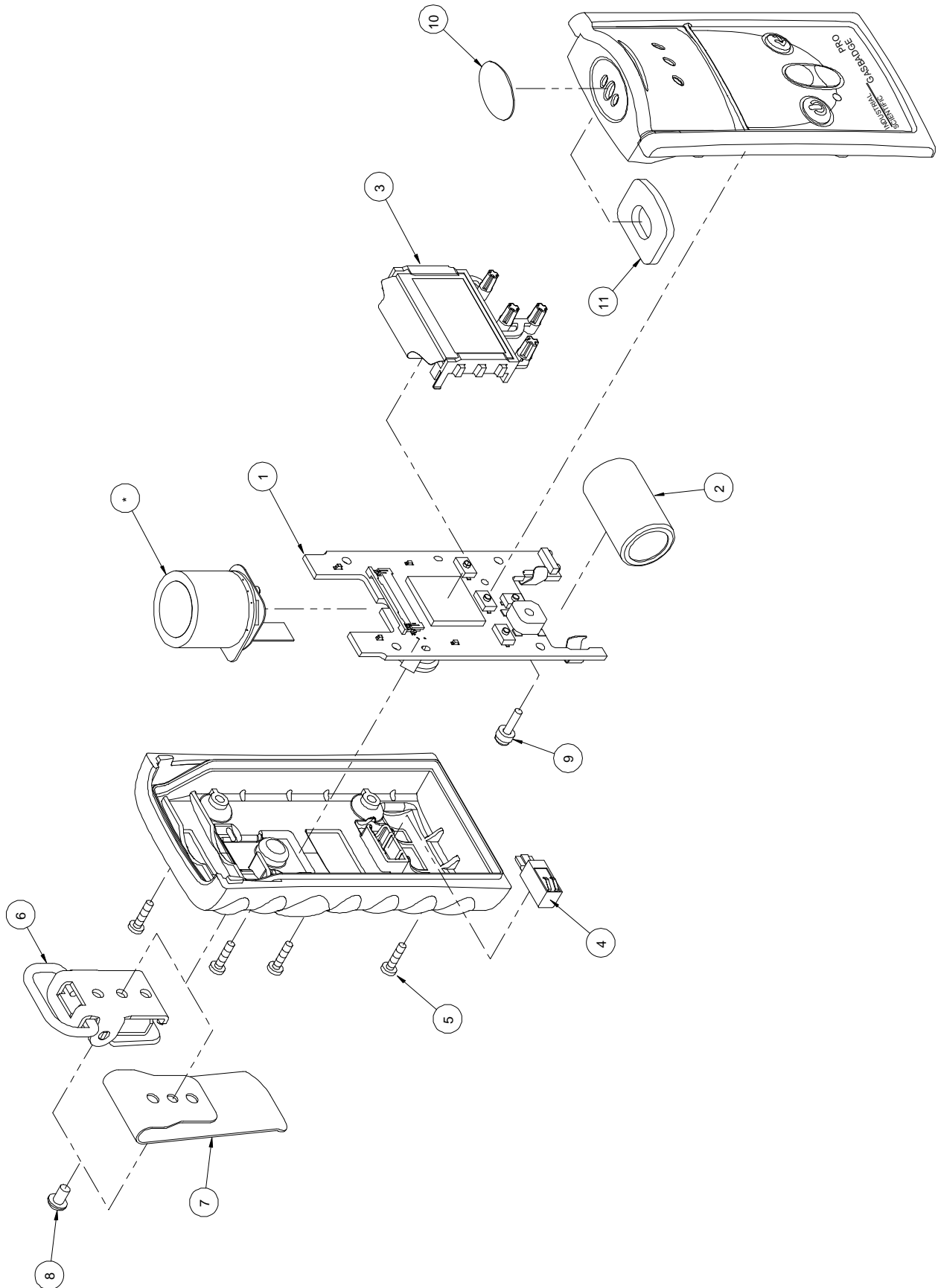

Detailed Components Drawing Showing Replacement Parts

Replacing the Sensor

To replace a GasBadge Pro sensor, follow the steps below.

1. Turn off the instrument.
2. Remove the four screws holding the case halves together.
3. Place the instrument face down on a flat surface.
4. Locate the sensor tail connector on the printed circuit board (PCB) and remove it. See item A in diagram 1.
5. Locate and remove the screw and washer holding the PCB onto the front case half. See item B in diagram 1.
6. Carefully pull the board away from the case top.
7. Remove the sensor from the case top. See item C in diagram 2.
8. Place the new sensor in the case top (see item C in diagram 2), ensuring that the sensor gasket is not damaged.
9. Place the PCB back into the case front.
10. Secure the PCB to the case front with the appropriate screw and washer. See item B in diagram 1.
11. Connect the sensor tail to the connector on the PCB. See item A in diagram 1.
12. Place the two case halves together.
13. Re-insert the four screws.
14. Calibrate the instrument.

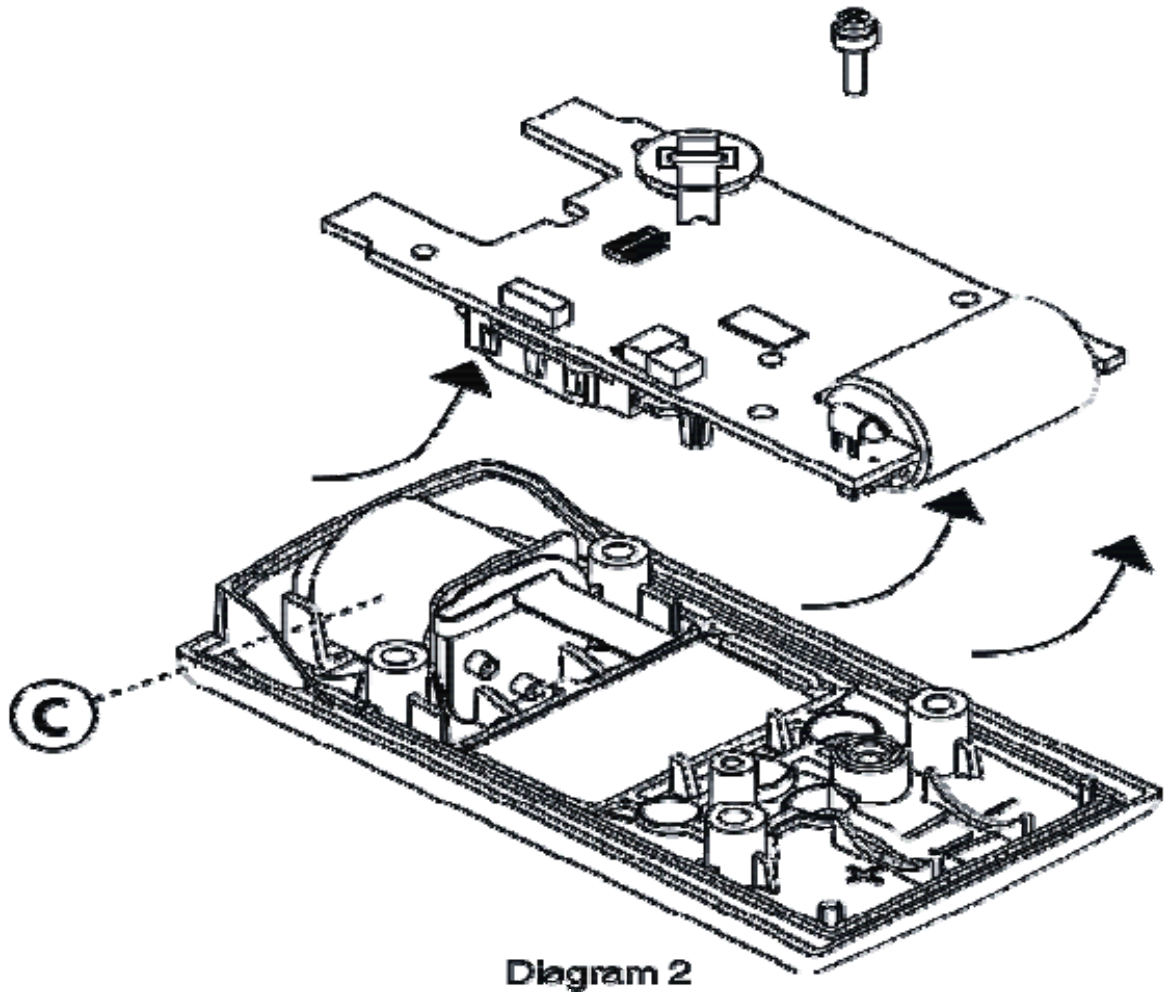
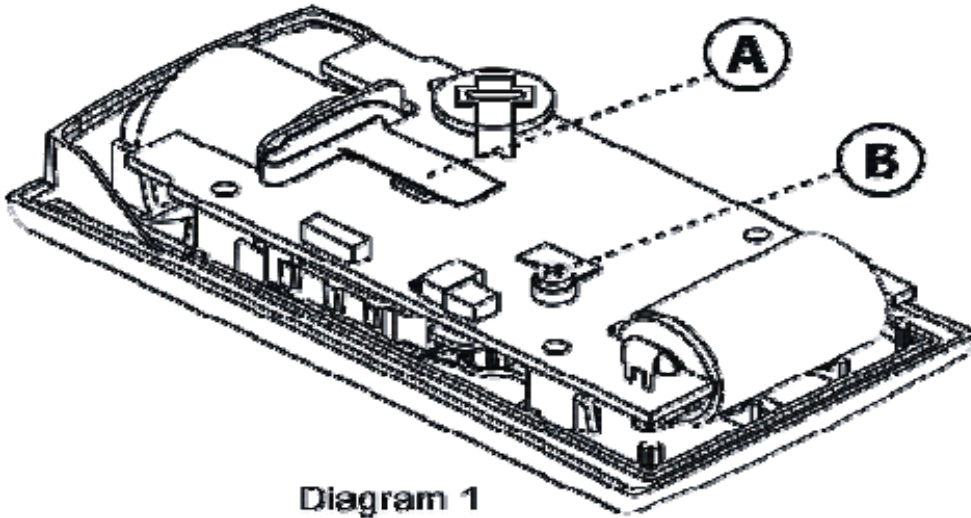

Sensor Replacement Components

Sensor Specifications

The sensors used in this instrument are listed below and operate with the measurement ranges, resolutions, accuracies, temperature ranges, and humidity ranges listed. The accuracies stated below are over the entire operating range of the sensor and defined over the range of calibration.

Sensor Specifications for the GasBadge Pro

Sensor Type	Range	Resolution	% Accuracy ¹		Sensor Temp Range °C (°F)	% RH Range ⁴
			Over Cal Range ²	Over Operating Range ³		
CO	0 – 1,500 ppm	1 ppm	± 5.0	± 15	-40 to +50 (-40 to 122)	15 – 90 %
H ₂ S	0 – 500 ppm	0.1 ppm	± 5.0	± 15	-40 to +50 (-40 to 122)	15 – 90 %
O ₂	0 – 30% vol	0.1%	± 0.5 ⁵	± 0.8 ⁵	-20 to +50 (-4 to 122)	0 – 99 %
NO ₂	0 – 150 ppm	0.1 ppm	± 5.0	± 15	-20 to +50 (-4 to 122)	15 – 90 %
SO ₂	0 – 150 ppm	0.1 ppm	± 5.0	± 15	-40 to +50 (-40 to 122)	15 – 90 %
NH ₃	0 – 500 ppm	1 ppm	± 10.0	± 15	-20 to +40 (-4 to 104)	15 – 90 %
Cl ₂	0 – 100 ppm	0.1 ppm	± 5.0	± 15	-20 to +40 (-4 to 104)	10 – 95 %
ClO ₂	0 – 1 ppm	0.01 ppm	± 5.0	± 15	-20 to +40 (-4 to 104)	15 – 90 %
PH ₃	0 – 10 ppm	0.01 ppm	± 5.0	± 15	-20 to +40 (-4 to 104)	20 – 95 %
HCN	0 – 30 ppm	0.1 ppm	± 5.0	± 15	-20 to +40 (-4 to 104)	20 – 95 %
H ₂	0 – 2,000 ppm	1 ppm	± 5.0	± 15	-20 to +40 (-4 to 104)	20 – 95 %

1 – For any given sensor reading, the accuracy shall be taken to be the greater value of the % value specified below or 1 count.

2 – Within calibration environment range

3 – Over entire operating temperature and %RH range

4 – Non-condensing

5 – Calibrated at 21% Oxygen (O₂)

Ordering Information – Accessories and Peripheral Equipment

Part Numbers for the GasBadge Pro and Related Components

Part #	Description
18100060-1	GasBadge® Pro with carbon monoxide (CO) sensor
18100060-2	GasBadge® Pro with hydrogen sulfide (H ₂ S) sensor
18100060-3	GasBadge® Pro with oxygen (O ₂) sensor
18100060-4	GasBadge® Pro with nitrogen dioxide (NO ₂) sensor
18100060-5	GasBadge® Pro with sulfur dioxide (SO ₂) sensor
18100060-6	GasBadge® Pro with ammonia (NH ₃) sensor
18100060-7	GasBadge® Pro with chlorine (Cl ₂) sensor
18100060-8	GasBadge® Pro with chlorine dioxide (ClO ₂) sensor
18100060-9	GasBadge® Pro with phosphine (PH ₃) sensor
18100060-B	GasBadge® Pro with hydrogen cyanide (HCN) sensor
18100060-C	GasBadge® Pro with hydrogen (H ₂) sensor
18100060-G	GasBadge® Pro with carbon monoxide/low hydrogen interference (CO/H ₂ null)
18106500	GasBadge® constant-flow hand aspirated pump
17121963	Neck lanyard with safety release
18106484	GasBadge® Pro nylon carrying case
18106492	GasBadge® Pro 2-unit nylon carrying case
17124504	Replacement water/dust sensor barriers (5 count)
17117714	Serial data thermal printer with infrared interface (battery powered)
18100701	Calibration gas – carbon monoxide (CO), 100 ppm, 34L
18104984	Calibration gas – hydrogen sulfide (H ₂ S), 25 ppm, 34L
18100271	Calibration gas – oxygen (O ₂), 20.9%, 34L
18104976	Calibration gas – nitrogen dioxide (NO ₂), 5 ppm, 34L
18104992	Calibration gas – sulfur dioxide (SO ₂), 5 ppm, 34L
78103868	Calibration gas – ammonia (NH ₃), 50 ppm, 58L
18105007	Calibration gas – chlorine (Cl ₂), 10 ppm, 34L
18104398	Calibration gas – phosphine (PH ₃), 1.0 ppm, 34L
18102152	Calibration gas – hydrogen cyanide (HCN), 10 ppm, 58L
18103945	Calibration gas – hydrogen (H ₂), 100 ppm, 34L
18100933	Regulator for CO, O ₂ and H ₂ (Gases in 34-liter steel cylinders)
18100883	Regulator for H ₂ S, NO ₂ , SO ₂ , NH ₃ , Cl ₂ , PH ₃ and HCN (aluminum cylinders)

GasBadge® Pro Personal Single Gas Monitor

18103564	Demand flow regulator for CO, O ₂ , H ₂ (for use with DS2 – 34-liter steel cyl.)
18102509	Demand flow regulator for H ₂ S, NO ₂ , SO ₂ , NH ₃ , Cl ₂ , PH ₃ and HCN (for use with DS2- aluminum cylinders)

General Specifications

Item	Description																						
Case	Rugged, water-resistant polycarbonate shell with protective concussion-proof overmold. RFI resistant.																						
Dimensions	3.7" × 2.0" × 1.1" (94.0 mm × 50.8 mm × 27.9 mm) (H×W×L)																						
Weight	3 oz (85 g)																						
Sensors	CO, H ₂ S, O ₂ , NO ₂ , SO ₂ , NH ₃ , Cl ₂ , ClO ₂ , PH ₃ , HCN, H ₂ and CO/H ₂ null																						
Measuring Ranges	<table style="width: 100%; border: none;"> <tr> <td style="width: 30%;">CO range:</td> <td>0-1,500 ppm in 1 ppm increments</td> </tr> <tr> <td>H₂S range:</td> <td>0-500 ppm in 0.1 ppm increments</td> </tr> <tr> <td>O₂ range:</td> <td>0-30% by volume in 0.1% increments</td> </tr> <tr> <td>NO₂ range:</td> <td>0-150 ppm in 0.1 ppm increments</td> </tr> <tr> <td>SO₂ range:</td> <td>0-150 ppm in 0.1 ppm increments</td> </tr> <tr> <td>NH₃ range:</td> <td>0-500 ppm in 1 ppm increments</td> </tr> <tr> <td>Cl₂ range:</td> <td>0-100 ppm in 0.1 ppm increments</td> </tr> <tr> <td>ClO₂ range:</td> <td>0-1 ppm in 0.01 ppm increments</td> </tr> <tr> <td>PH₃ range:</td> <td>0-10 ppm in 0.01 ppm increments</td> </tr> <tr> <td>HCN range:</td> <td>0-30 ppm in 0.1 ppm increments</td> </tr> <tr> <td>H₂ range:</td> <td>0-2,000 ppm in 1 ppm increments</td> </tr> </table>	CO range:	0-1,500 ppm in 1 ppm increments	H ₂ S range:	0-500 ppm in 0.1 ppm increments	O ₂ range:	0-30% by volume in 0.1% increments	NO ₂ range:	0-150 ppm in 0.1 ppm increments	SO ₂ range:	0-150 ppm in 0.1 ppm increments	NH ₃ range:	0-500 ppm in 1 ppm increments	Cl ₂ range:	0-100 ppm in 0.1 ppm increments	ClO ₂ range:	0-1 ppm in 0.01 ppm increments	PH ₃ range:	0-10 ppm in 0.01 ppm increments	HCN range:	0-30 ppm in 0.1 ppm increments	H ₂ range:	0-2,000 ppm in 1 ppm increments
CO range:	0-1,500 ppm in 1 ppm increments																						
H ₂ S range:	0-500 ppm in 0.1 ppm increments																						
O ₂ range:	0-30% by volume in 0.1% increments																						
NO ₂ range:	0-150 ppm in 0.1 ppm increments																						
SO ₂ range:	0-150 ppm in 0.1 ppm increments																						
NH ₃ range:	0-500 ppm in 1 ppm increments																						
Cl ₂ range:	0-100 ppm in 0.1 ppm increments																						
ClO ₂ range:	0-1 ppm in 0.01 ppm increments																						
PH ₃ range:	0-10 ppm in 0.01 ppm increments																						
HCN range:	0-30 ppm in 0.1 ppm increments																						
H ₂ range:	0-2,000 ppm in 1 ppm increments																						
Display	Custom LCD with graphical icons for easy use. Segmented display for direct gas readings. Backlight for low light conditions. "Go/No Go" display mode. Peak reading indication.																						
Alarms	User selectable low and high alarms. Ultra bright LEDs. Loud audible alarm (95 dB). Vibrating alarm.																						
Battery/ Runtime	User-replaceable 3V, CR2 lithium battery. 2,600 hour run time (minimum).																						
Event Logger	Continually on. Logs last 15 alarm events, stamping how long ago the event occurred, the duration of the event, and the peak reading seen during the event. Event logger can be viewed on a PC or printed directly from the instrument to an infrared printer.																						
Data Logger	One year at one-minute intervals																						
Temperature	-40° C to 60° C (-40° F to 140° F)																						
Humidity	0% to 99% RH (non-condensing), typical																						
Buttons	Four (Mode, Enter, Up Arrow, and Down Arrow)																						

Lifetime Warranty Policy

Industrial Scientific Corporation portable gas monitoring instruments are warranted to be free from defects in material and workmanship for as long as the instrument is in service.

The above warranty does not include sensors, battery packs, internal pumps or filters, all of which are warranted to be free from defects in material and workmanship for 18 months from the date of shipment, or 1 year from the date of first use, whichever occurs first, except where otherwise stated in writing in Industrial Scientific literature accompanying the product.

All other Industrial Scientific products are warranted to be free from defects in material and workmanship for a period of 18 months from the date of shipment, or 1 year from the date of first use, whichever occurs first, except where otherwise stated in writing in Industrial Scientific literature accompanying the product.

Limitation of Liability

Industrial Scientific makes no other warranties, either expressed or implied, including but not limited to the warranties of merchantability or fitness for particular purpose.

Should the product fail to conform to the above warranty, buyer's only remedy and Industrial Scientific's only obligation shall be, at Industrial Scientific's sole option, replacement or repair of such non-conforming goods or refund of the original purchase price of the non-conforming goods.

In no event will Industrial Scientific be liable for any other special, incidental or consequential damages, including loss of profit or loss of use, arising out of the sale, manufacture or use of any products sold hereunder whether such claim is pleaded in contract or in tort, including strict liability in tort.

It shall be an express condition to Industrial Scientific's warranty that all products be carefully inspected for damage by Buyer upon receipt, be properly calibrated for Buyer's particular use, and be used, repaired, and maintained in strict accordance with the instructions set forth in Industrial Scientific's product literature. Repair or maintenance by non-qualified personnel will invalidate the warranty, as will the use of non-approved consumables or spare parts.

As with any other sophisticated product, it is essential and a condition of Industrial Scientific's warranty that all personnel using the products be fully acquainted with their use, capabilities and limitations as set forth in the applicable product literature. Buyer acknowledges that it alone has determined the intended purpose and suitability of the goods purchased.

It is expressly agreed by the parties that any technical or other advice given by Industrial Scientific with respect to the use of the goods or services is given without charge and at

Buyer's risk; therefore, Industrial Scientific assumes no obligations or liability for the advice given or results obtained.

Agency Certifications

Directive/Code	Approval / Specification Information
UL/cUL	Class I, Groups A, B, C, D; Class II, Groups E, F, G; Class III: Temperature Code T4
CSA/CSAUS	Class I, Div 1, Groups A, B, C, D; Temperature Code T4
ATEX	Intrinsic Safety: EX ia I/IIC T4; Equipment Group and Category: I M1 and II 1G.
Australia	Ex ia I/IIC T4
IEC	Ex ia I/IIC T4
Russia	GOST-R Approval

Corporate Headquarters
Industrial Scientific Corporation
1001 Oakdale Road
Oakdale, PA 15071-1500
Phone: (412) 788-4353
1-800-DETECTS (338-3287)
Fax: (412) 788-8353
e-mail: info@indsci.com

Industrial Scientific Asia-Pacific
Asia-Pacific Headquarters
290 Guiqiao Rd.
Pudong, Shanghai 201206
People's Republic of China
Phone: +86 21 5899 3279
Fax: +86 21 5899 3280
e-mail: info@ap.indsci.com

Singapore
Industrial Scientific Corporation Pte. Ltd.
7 International Business Park
#03-01 TechQuest Building
Singapore 609919
Phone: +65 6561 7377
Fax: +65 6561 7787
e-mail: info@ap.indsci.com

Australia
Industrial Scientific Australia Pty. Ltd.
Level 5, 113 Wicks Road
North Ryde, NSW 2113
Australia
Phone: +61 2 8870 3400
Fax: +61 2 8870 3444
e-mail: info@ap.indsci.com

Industrial Scientific Oldham
Industrial Scientific Oldham Headquarters
Z.I. Est – rue Orfila
B.P. 417
62 027 Arras Cedex
France
Phone: +33 3 21 60 80 80
Fax: +33 3 21 60 80 00
e-mail: info@eu.indsci.com

Germany
Industrial Scientific Winter GmbH
Gernotstr. 19
44319 Dortmund
Germany
Phone: +49 231 9241 0
Fax: +49 231 9241 25
e-mail: info@winter-gmbh.com

The Netherlands
Industrial Scientific B. V.
Westbroek 52
4822 ZW Breda
The Netherlands
Phone: +31 76 5427 609
Fax: +31 76 5427 197
e-mail: info@eu.indsci.com

United Arab Emirates / Dubai
Industrial Scientific FZCO
P.O. Box 261086, Jebel Ali
Dubai
United Arab Emirates
Phone: +971 50 455 8518
Fax: +971 4 367 5919
e-mail: info@eu.indsci.com

All trademarks and registered trademarks are the property of their respective owners.
Although every effort is made to ensure accuracy, the specifications of this product and the
content herein are subject to change without notice.

© 2005-2007 Industrial Scientific. All rights reserved.





MANUFACTURER DECLARATION OF CONFORMITY
Déclaration de Conformité Constructeur



The company **Industrial Scientific Corporation**, Oakdale, Pennsylvania USA, declares that the following new material intended for use in Explosive Atmospheres:
(La société **Industrial Scientific Corporation**, Oakdale, Pennsylvania USA, atteste que le matériel neuf destiné à être utilisé en Atmosphères Explosives désigné ci-après :)

Gas detector (Détecteur de gaz) GasBadge Pro

comply with the requirements of the following European Directives :
(est conforme aux exigences des Directives Européennes suivantes):

I) The European Directive ATEX 94/9/CE of 23/03/94: Explosive Atmospheres
Directive Européenne ATEX 94/9/CE du 23/03/94 : Atmosphères Explosives

No. of EC type examination certificate: **LCIE 10 ATEX 3088X**
(N° Attestation CE de Type du matériel):
Issued by the Notified Body no. 0081: **LCIE**
(Délivré par l' Organisme notifié sous le numéro 0081) 92266 Fontenay-aux-Roses cedex, France

Reference European Standards (Normes européennes de référence):

Rules of construction (Règles de construction) : EN 60079-0, EN 60079-11

Category (Catégorie) :  II 1G / I M1
Ex ia IIC T4 / Ex ia I
Tamb -40°C to +60°C

Production Quality Assurance Notification No. of the Oakdale factory SIRA 00 ATEX M0080
(N° de la Notification Assurance Qualité de Production de l'usine de Oakdale)

Issued by the Notified Body no. 0518: **SIRA Certification Services, Rake Lane**
(Délivré par l'Organisme notifié sous le numéro 0518) Eccleston, Chester CH4 9JN, UK

II) The European Directive EMC 2004/108/EC of 15/12/04: Electromagnetic Compatibility
Directive Européenne CEM 2004/108/CE du 15/12/04 : Compatibilité Electromagnétique

Harmonised applied standards: EN 50270
(Normes harmonisées appliquées)

On behalf of the manufacturer
Pour le fabricant

Industrial Scientific Corporation
1001 Oakdale Road
Oakdale PA, 15071 USA
Tel +01 412 788 4353
www.indsci.com

On behalf of the manufacturer representative in EC
Pour le représentant du fabricant dans l'UE

Industrial Scientific Oldham
Z.I. EST - B.P. 417
62027 ARRAS Cedex - FRANCE
Tel +33 3 21 60 80 80

The ATEX Authorized Representative
La Personne Autorisée ATEX

Tom Mikulin
Director, Engineering
Directeur Technique
28 July 2011



OUR MISSION
Preserving human life on, above and below the earth
Delivering highest quality, best customer service ...
every transaction, every time

CE/ATEX/Oak/0804 rev c

Oakdale, PA, July 2011, 2nd

