

Dynabrade Portable Abrasive Belt Tools

Grind, Deburr, Blend, Clean, Polish and Finish

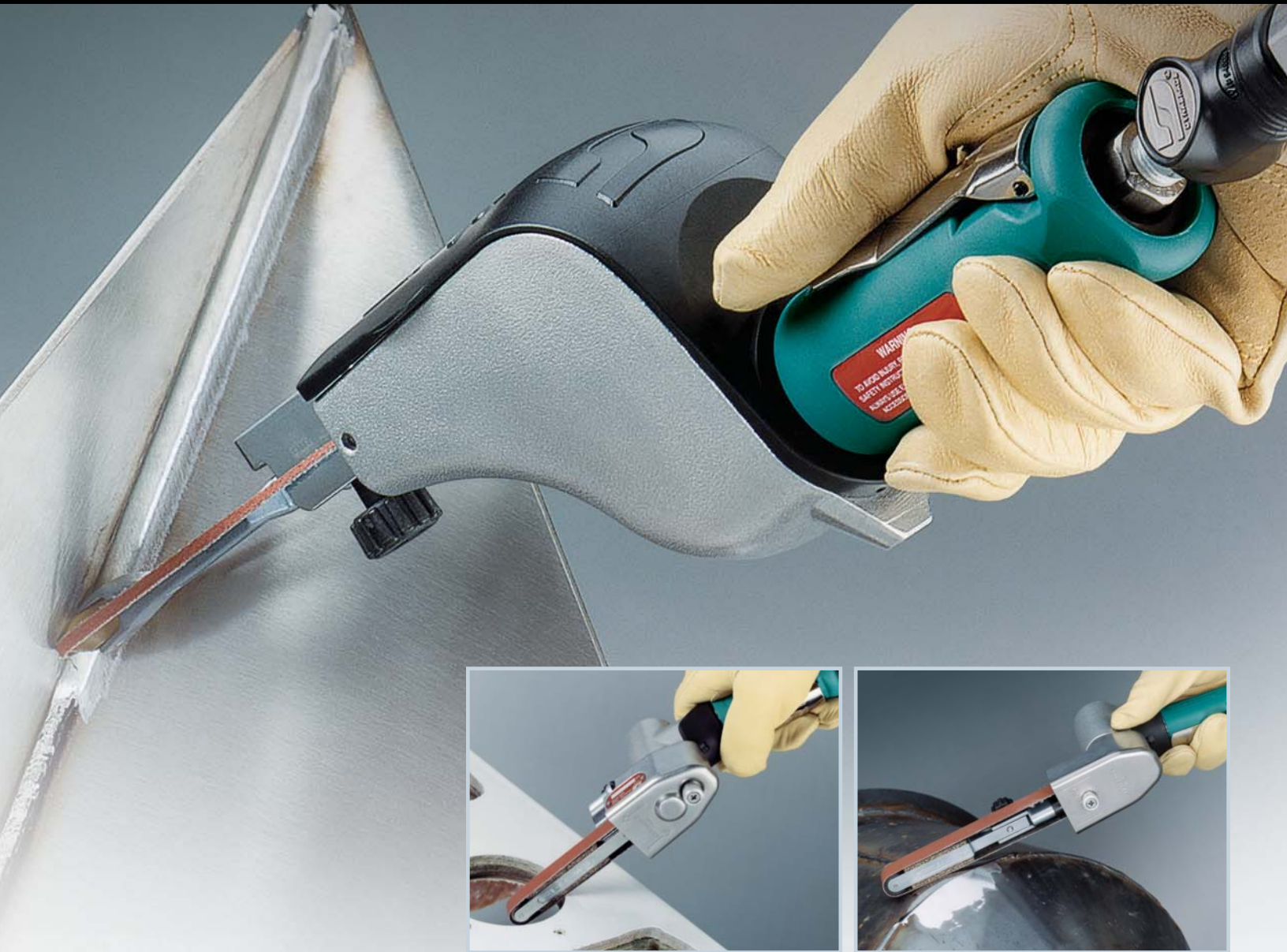

Dynabrade Abrasive Belt Tools...



We offer a diverse line of products to help you get the job done. With expert knowledge, service and free product demonstrations, we'll show you how...

An Amazing Array of Versatility!



See NEW Electric Model on page 11!

Discover The Dynabrade Difference!



DYNABRADE ABRASIVE BELT



World-famous **14000 Dynafiler®** replaces tedious hand-sanding and filing in an endless array of applications. Tool above is powering optional **11237 Contact Arm**, ideal for working in areas as small as 3/8" (10 mm). This arm is also utilized for turbine blade grinding, blending and polishing.



40320 Dynafiler® II offers ergonomic 7° offset design. The tool's grinding head pivots a full 360° for securing in most efficient position. Application shows **Dynafiler® II** fitted with optional **11204 Contact Arm**, allowing slack of abrasive belt to efficiently polish radiused areas.



15300 Dynafiler® III serves up more power for faster material removal. Corner weld shown is easily taken down with optional **15357 Contact Arm**, with "V" shaped Contact Wheel. This arm is also reversible, effective for both platen sanding and slack polishing.



Heavy-Duty **11476 Dynabelter®** is utilized for grinding cylinders, deburring castings and fabricating metals. Fitted with **11681 Contact Arm** (included), **Dynabelter®** effectively grinds weld seams and achieves in-line scratch pattern.

Dynabrade, Inc., global leader in pneumatic tool technology, presents our line of portable Abrasive Belt Tools. Beginning with the world-famous Dynafiler® and including over 20 models, these tools offer an amazing variety of industrial application solutions!

TOOL USES & APPLICATIONS



15003 Mini-Dynaflex® II is a lightweight, compact tool, powering 12" (305 mm) long belts for a variety of applications. Tool includes **15026 Contact Arm**, ideal for grinding and finishing on edges or grooves, and within corners.



15420 Dynaflex® III includes unique **11702 Contact Arm** with 4" (102 mm) diameter wheel, for grinding or blending right angle welds and fillet welds. This arm also comes with helpful hand guide, for enhanced operator control.



From grinding a weld to repairing a surface defect, Dynabrade offers the Abrasive Belt Tool for the job!



40353 Dynaflex® II (.4 hp) is designed for exclusive use with non-woven nylon belts. This tool is excellent for setting grain lines, achieving consistent satin finishes, and removing oxide or weld discoloration. Shown with optional **11204 Contact Arm**, with offset design ideal for slack polishing.



14300 Dynangle® II accepts abrasive belts 2" wide by 34" long (51 mm x 864 mm), effective for slack polishing of cylindrical surfaces up to 36" (914 mm) in diameter. This machine is also great for surface conditioning on flat surfaces, using optional platen accessory.



"The Original" Dynafile®

Air-Powered Abrasive Belt Tool

The Best Tracking Abrasive Belt Tool in the World!

- World-famous Dynafile® replaces tedious hand filing and sanding. Grind, deburr, blend, polish, finish and more!
- Grind from contact wheel or platen pad. Finish and polish using slack of belt.
- For use on metal, plastic, fiberglass, composites, rubber, glass and stone.
- Motor easily adjusts to the most comfortable throttle lever position.
- Superior belt tracking permits use of 1/8", 1/4" or 1/2" wide x 24" long abrasive belts.
- Work in areas as small as 3/8" diameter.
- Lightweight composite belt guard allows quick and easy belt change!
- Hard and soft platen pads mount onto contact arms for heavy grinding or contour polishing (see page 25).

Model 14000 For 24" Long Belts

- Includes 11218 Contact Arm for standard use. Also accepts a variety of additional Contact Arms (see page 7).

14010 Versatility Kit

- Includes 14000 Dynafile® with five popular Contact Arms, plus an assortment of abrasive belts, in durable case.
- Includes Contact Arms 11213, 11216, 11218, 11219 and 11231 (see page 7).
- This kit is USA Government National Stock Number 5130011263260.



Reach into areas as small as 3/8".



Clean and finish using non-woven nylon belts.



Efficiently rework turbine blades with specialized contact arm.



Grind welds using belts as narrow as 1/8" wide.



FOR ABRASIVE BELTS
1/8", 1/4", 1/2" wide x 24" long
(3 mm, 6 mm, 13 mm x 610 mm)



Model 14000

The most recognized shape in portable abrasive belt tools!



Model 14010

Model Number	Motor hp (W)	Motor RPM	Sound Level	Abrasive Belt Size Inch (mm)	Maximum Air Flow SCFM (LPM)	Max. SFPM (SMPM)	Air Inlet Thread	Weight Pound (kg)	Length Inch (mm)	Height Inch (mm)
14000	.5 (373)	20,000	77 dB(A)	1/8-1/2 (3-13) W x 24 (610) L	31 (878)	5,800 (1,762)	1/4" NPT	3.1 (1.4)	14.6 (371)	4.6 (116)

Additional Specifications: Air Pressure 90 PSIG (6.2 Bar) • Hose I.D. Size 1/4" (6 mm)

Tune-Up Kit: No. 95600

Dynafile® Contact Arms

4" to 14" Workable Reach



Part Number	Comments	Belt Size (W x L)	Contact Wheel Assembly (includes bearing and shaft)	Platen Pad
11178, 11179, 11257	<ul style="list-style-type: none"> Up to 32" reach Enter slots as narrow as 3/8" Deburr 1/2" to 1" tubing 	11178: 1/2" x 34" (9" reach with 5/16" dia. steel contact wheel) 11179: 1/2" x 34" (9" reach with 5/8" dia. rubber contact wheel)	11178: 11068 Wheel (5/16" dia. steel) 11179: 11078 Wheel (5/8" dia. rubber)	None
11257: Custom-made. Specify length and contact wheel.				
11212	<ul style="list-style-type: none"> 45 PSIG maximum File round openings as small as 7/16" 	1/4" x 24"	11066 5/16" dia. x 1/8" wide, steel	11034 1/4" wide; Thin
11213	<ul style="list-style-type: none"> 45 PSIG maximum See 11239 for heavy-duty version 	1/2" x 24"	11068 5/16" dia. x 3/8" wide, steel	11027 1/2" wide; Thin
11214	<ul style="list-style-type: none"> 45 PSIG maximum Work on contact wheel or platen pad 	1/2" x 24"	11070 7/16" dia. x 3/8" wide, rubber	11025 1/2" wide; Soft
11215	<ul style="list-style-type: none"> Enter 1/2" x 1/2" openings 	1/4" x 24"	11072 7/16" dia. x 1/8" wide, brass	11034 1/4" wide; Thin
11216	<ul style="list-style-type: none"> Enter 5/16" x 3/4" openings 	1/4" x 24"	11074 5/8" dia. x 1/8" wide, rubber	11032 1/4" wide; Soft
11217	<ul style="list-style-type: none"> Enter channels as narrow as 9/16" 	1/2" x 24"	11076 7/16" dia. x 3/8" wide, steel	11027 1/2" wide; Thin
11218	<ul style="list-style-type: none"> Standard on Model 14000 See 11228 for heavy-duty version 	1/2" x 24"	11078 5/8" dia. x 3/8" wide, rubber	11025 1/2" wide; Soft
11219, 11252	<ul style="list-style-type: none"> No platen due to offset design Ideal for slack polishing; also grinding radiuses 	1/4" or 1/2" x 24"	11219: 11080 Wheel, 1" dia. x 3/8" wide, 70 duro 11252: 11093 Wheel, 1" dia. x 3/8" wide, 40 duro (Both wheels radiused rubber)	None
11228	<ul style="list-style-type: none"> Heavy-duty steel Optional 11028 Steel Platen available for grinding 	1/2" x 24"	11078 5/8" dia. x 3/8" wide, rubber	11025 1/2" wide; Soft
11231	<ul style="list-style-type: none"> See 11243 for heavy-duty version 	1/2" x 24"	11084 3/4" dia. x 1/2" wide, rubber	11135 1/2" wide; Hard
11232 "V" Shaped Wheel	<ul style="list-style-type: none"> For 1/8" wide belts No platen due to offset design Grind corners, strap polish 	1/8" or 1/4" x 24"	11086 1" dia. x 3/8" wide, tapered urethane	None

Dynaflex® Contact Arms

4" to 14" Workable Reach



Part Number	Comments	Belt Size (W x L)	Contact Wheel Assembly (includes bearing and shaft)	Platen Pad
11234	 <ul style="list-style-type: none"> • Deburrs both edges of workpiece simultaneously • Contact wheels adjust for material 1/8" to 5/8" thick 	1/2" x 34"	11080 (two) 1" dia. x 3/8" wide, rubber	None
11237, 11238 Turbine Blade Arm	 <ul style="list-style-type: none"> • 45 PSIG maximum • Grind, blend and polish turbine blades • Reach areas as small as 5/16" wide • 1-1/2" strap polish area 	11237: 1/4" x 24" 11238: 1/2" x 24"	11237: 5/16" dia. x 1/8" wide, steel wheel 11238: 1/4" dia. x 3/8" wide, steel (Consists of three 11051 Bearings)	None
11239	 <ul style="list-style-type: none"> • 45 PSIG maximum • Heavy-duty steel • Grind in narrow areas 	1/2" x 24"	11068 5/16" dia. x 3/8" wide, steel	11027 1/2" wide; Thin
11240	 <ul style="list-style-type: none"> • 9" workable reach 	1/2" x 34"	11078 5/8" dia. x 3/8" wide, rubber	11025 1/2" wide; Soft
11241	 <ul style="list-style-type: none"> • 9" workable reach 	1/4" x 34"	11074 5/8" dia. x 1/8" wide, rubber	11032 1/4" wide; Soft
11243	 <ul style="list-style-type: none"> • Heavy-duty steel • Grind over contact wheel or platen pad 	1/2" x 24"	11084 3/4" dia. x 1/2" wide, rubber	11135 1/2" wide; Hard
11244, 11245	 <ul style="list-style-type: none"> • 14" workable reach 	11244: 1/2" x 44" 11245: 1/4" x 44"	11078 5/8" dia. x 3/8" wide, rubber	11025 1/2" wide; Soft
11253, 11254 Big Wheel Arm	 <ul style="list-style-type: none"> • Grinds and polishes deep slots or narrow grooves 	1/4" to 1/2" x 34"	1/4" or 1/2" wide wheels, 2-1/8" or 4-3/4" diameter (specify size)	
11255 Cross Bow Arm	 <ul style="list-style-type: none"> • I.D. polish, deburr or ream with one 180° wrist turn • Deburr leading radius of 1" to 4" round openings • Great for pipe fitters 	1/2" x 34"	11078 5/8" dia. x 3/8" wide, rubber	None
11258 Stroke Sander Arm	 <ul style="list-style-type: none"> • Blend stainless steel 	1/2" x 24"	11078 5/8" dia. x 3/8" wide, rubber 11076 7/16" dia. x 3/8" wide, steel	11025 1/2" wide; Soft
11261 "The Banana Arm"	 <ul style="list-style-type: none"> • For in-line scratch pattern 	1/2" x 24"	11078 5/8" dia. x 3/8" wide, rubber	11132 1/2" wide;
11262 Offset Arm	 <ul style="list-style-type: none"> • For flat grinding using platen at or near corners and edges of large radiuses • Contact wheel is offset to prevent gouging 	1/2" x 24"	11078 5/8" dia. x 3/8" wide, rubber	11026 1/2" wide; Hard
11297 Guide-Cut Arm	 <ul style="list-style-type: none"> • Guide wheels prevent undercutting • Removes raised material within .020" or less • Use 60 to 80 grit belts 	1/2" x 24" 60 to 80 grit	11090 5/8" dia. x 3/8" wide, rubber	None

Dynafile® II

Air-Powered Abrasive Belt Tool

Reach Normally Inaccessible Areas

- Grind, deburr, blend and polish, on metal, plastic, fiberglass, composites, rubber, glass and more. Grind from contact wheel or platen pad; finish and polish using slack of belt.
- Lightweight, ergonomic 7° offset design. Grinding head pivots 360° for securing in most efficient position.
- Belt guard easily detaches for quick abrasive change; simple belt tracking adjustment knob.

FOR ABRASIVE BELTS

1/8" to 3/4" wide x 18" long
(3 mm - 19 mm x 457 mm)

18" Long Belt Models

Model 40320

- Includes 11206 Contact Arm (see page 12), for 3/4" wide x 18" long belts.

Model 40335

- Designed exclusively for use with non-woven nylon belts. Excellent for setting grain lines, achieving consistent satin finishes on metals, removing oxide and weld discoloration.
- 40375 Rubber Drive Wheel minimizes non-woven nylon belt slippage. Straight belt path extends abrasive life.
- Includes 11203 Contact Arm for 1/2" wide x 18" long medium non-woven nylon belt (90292).

Model 40381 *Slow Speed*

- 1,500 SFPM. Slow speed ensures longer belt life when working on titanium and other exotic materials.
- Includes 11206 Contact Arm (see page 12), for 3/4" wide x 18" long belts.

20-1/2" Long Belt Model

Model 40326

- Includes 11287 Contact Arm for 5/8" or 3/4" wide abrasive belts. (11287 is only arm that accepts 20-1/2" long belts.)

Versatility Kits

40321 Versatility Kit

- Includes 40320 Dynafile® II with 11206 Contact Arm, plus additional 11203 and 11204 Contact Arms. Also includes eight popular abrasive belts, three platen pads, and 50010 Collet (1/4") for Die Grinder use, along with 95262 and 95281 Wrenches. All items contained in a durable carrying case.

40324 Versatility Kit *Metric*

- Includes 40320 Dynafile® II with 11206 Contact Arm, plus additional 11203 and 11320 Contact Arms. Also includes eight popular abrasive belts, three platen pads, and 50015 Collet (6 mm) for Die Grinder use, along with 95262 and 95281 Wrenches. All items contained in a durable carrying case.



TECH TIP

Dynafile® II easily converts to a Die Grinder with optional 50010 Collet (1/4") or 50015 Collet (6 mm). To convert to a Drill, order 53032 Chuck (1/4").



Model Number	Motor hp (W)	Motor RPM	Sound Level	Abrasive Belt Size Inch (mm)	Maximum Air Flow SCFM (LPM)	Max. SFPM (SMPM)	Weight Pound (kg)	Length Inch (mm)	Height Inch (mm)
40320	.5 (373)	20,000	80 dB(A)	1/8-3/4 (3-19) W x 18 (457) L	28 (793)	4,550 (1,382)	2.5 (1.1)	14-1/4 (362)	4-7/8 (124)
40326	.5 (373)	20,000	80 dB(A)	1/8-3/4 (3-19) W x 20-1/2 (521) L	28 (793)	4,550 (1,382)	2.5 (1.1)	14-1/4 (362)	4-7/8 (124)
40335	.5 (373)	20,000	80 dB(A)	1/8-3/4 (3-19) W x 18 (457) L	28 (793)	4,550 (1,382)	2.5 (1.1)	14-1/4 (362)	4-7/8 (124)
40381	.4 (321)	5,000	82 dB(A)	1/8-3/4 (3-19) W x 18 (457) L	24 (680)	1,500 (457)	2.8 (1.2)	15-1/2 (394)	5-3/4 (146)

Additional Specifications: Air Inlet Thread 1/4" NPT • Hose I.D. Size 3/8" (10 mm) • Air Pressure 90 PSIG (6.2 Bar)

Tune-Up Kits: Models 40320, 40326, 40335 – No. 96044; Model 40381 – No. 96174

.4 hp Dynafile® II

Air-Powered Abrasive Belt Tool

Lightweight, Low Profile Version of Dynafile® II

- .4 hp Dynafile® II adds a lightweight, compact variation to Dynabrade's famous Abrasive Belt Tool line. The optimal low profile belt tool for working in tight areas!
- Grind, deburr, blend, finish and polish. Grind from contact wheel or platen pad; finish and polish using slack of belt.
- For use on metal, plastic, fiberglass, composites, glass and more.
- Compact, low profile housing allows easy access in tight spots and previously inaccessible areas.
- Grinding head pivots 360° for additional flexibility.
- Ergonomic 7° offset handle.
- Robust .4 hp air motor serves up ample power.
- Lightweight tool design minimizes operator fatigue and increases efficiency.
- Belt guard easily detaches for quick abrasive change; simple belt tracking adjustment knob.

FOR ABRASIVE BELTS
1/8", 1/4", 3/4" wide x 18" long
(3 mm, 6 mm, 19 mm x 457 mm)

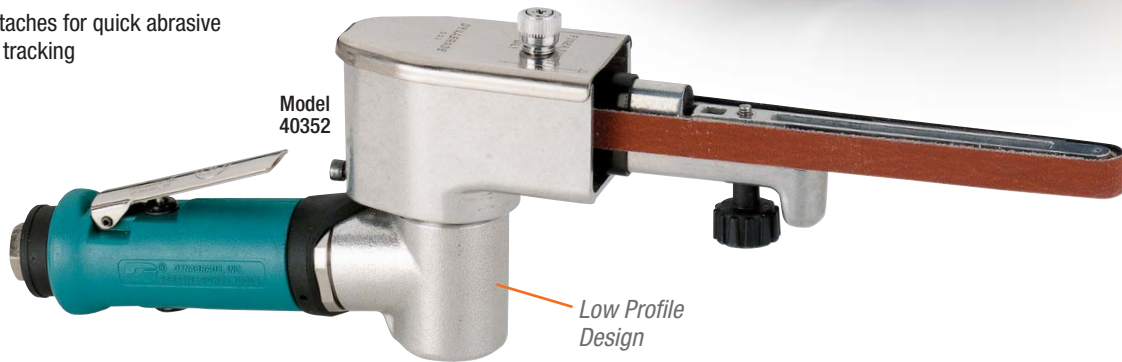

Model 40352 For 18" Long Belts

- Includes 11203 Contact Arm (see page 12), for coated abrasive belts 1/2" wide x 18" long.

Model 40353 For 18" Long Belts

- Designed exclusively for use with non-woven nylon belts.
- Excellent for setting grain lines, achieving consistent satin finishes on a variety of metals, and removing oxide and weld discoloration.
- 40375 Rubber Drive Wheel minimizes non-woven nylon belt slippage.
- Includes 11203 Contact Arm for 1/2" wide x 18" long medium non-woven nylon belt (90292).

TECH TIP

Dynaswivel® air line connector is ideal for use with most air tools. The Dynaswivel® improves tool maneuverability, minimizes operator fatigue and extends hose life (see page 29).



.4 hp Dynafile® II is ideal for deburring and finishing in tight areas.



Optional 11204 Contact Arm offers ability to grind into contours.



Optional offset Contact Arm allows belt to conform to a variety of contours.

Model Number	Motor hp (W)	Motor RPM	Sound Level	Abrasive Belt Size Inch (mm)	Maximum Air Flow SCFM (LPM)	Max. SFPM (SMPM)	Weight Pound (kg)	Length Inch (mm)	Height Inch (mm)
40352	.4 (298)	25,000	79 dB(A)	1/8 - 3/4 (3 - 19) x 18 (457)	22 (626)	5,730 (1,747)	1.9 (.86)	14 (356)	4-1/8 (105)
40353	.4 (298)	25,000	79 dB(A)	1/8 - 3/4 (3 - 19) x 18 (457)	22 (626)	5,730 (1,747)	1.9 (.86)	14 (356)	4-1/8 (105)

Additional Specifications: Air Inlet Thread 1/4" NPT • Hose I.D. Size 3/8" (10 mm) • Air Pressure 90 PSIG (6.2 Bar)

Tune-Up Kit: No. 96074

Vacuum Dynafile® II

Air-Powered Abrasive Belt Tool

Vacuum While You Work!

- Excellent for grinding, deburring, finishing and polishing, on wood, plastic, fiberglass and exotic metals.
- Highly portable vacuum system works on tool's exhaust.
- Includes self-contained "bag-within-bag" dust collection system. 54288 "bag-within-bag" system also sold separately.
- Air line is included and joined to exhaust hose to form "one cord" for superb maneuverability.

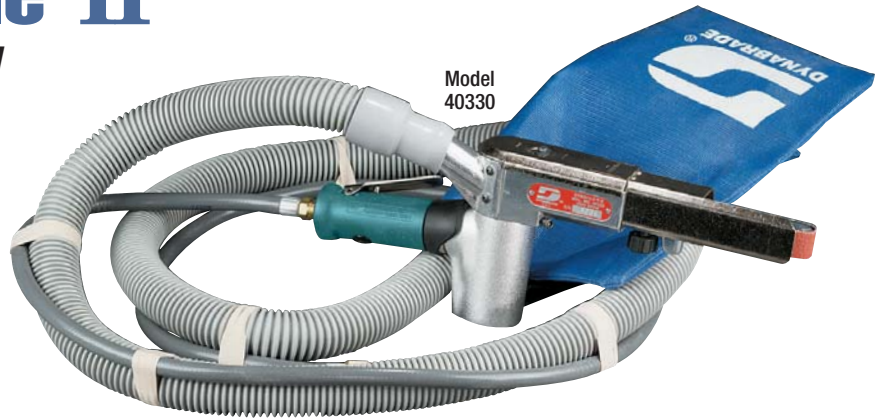

Model 40330

- Includes 11206 Contact Arm (see page 12), for 3/4" wide x 18" long abrasive belts.

Model Number	Motor hp (W)	Motor RPM	Sound Level	Abrasive Belt Size Inch (mm)	Maximum Air Flow SCFM (LPM)	Max. SFPM (SMPM)	Weight Pound (kg)	Length Inch (mm)	Height Inch (mm)
40330	.5 (373)	20,000	93 dB(A)	1/4-3/4 (6-19) W x 18-24 (457-610) L	28 (793)	4,550 (1,382)	2.5 (1.1)	14-1/4 (362)	5 (127)

Additional Specifications: Air Inlet Thread 1/4" NPT • Hose I.D. Size 3/8" (10 mm) • Air Pressure 90 PSIG (6.2 Bar)
Tune-Up Kit: No. 96044

Electric Dynafile® II

Electric-Powered Abrasive Belt Tool

Electric Version of World-Famous Abrasive Belt Tool

- Electric Dynafile® II runs coated abrasive and non-woven nylon belts, and is ideal for countless applications on metal, plastic, fiberglass, solid surface, stone, glass, etc.
- Grind with contact wheel or platen pad. Finish and polish using slack of belt.
- Tool accepts over 20 interchangeable contact arms (see page 12), for use with belts 1/4" to 3/4" wide x 18" long.
- Comfortable switch with "lock on" feature.
- Easily accessible brushes for quick replacement.
- Sanding head pivots 360°, for working in previously inaccessible areas.
- Reversible side handle for operator comfort.
- Tool is double-insulated for safety, and includes electric cord, 8 feet in length.



NEW!

120 V (AC)

Model 40610 11,000 RPM

- Tool includes 11203 Contact Arm, for abrasive belts 1/2" wide by 18" long.

40611 Versatility Kit

- Includes 40610 Electric Dynafile® II with 11203 Contact Arm, and two additional arms (11202 and 11204). Also includes eight abrasive belts of various grits, and an assortment of platen pads. All items contained in a durable carrying case.



Model Number	Motor RPM	Maximum Watts Out	Abrasive Belt Size Inch (mm)	Voltage	Current Amps	Phase	Frequency	Weight Pound (kg)	Length Inch (mm)	Height Inch (mm)
40610	11,000	680	1/4-3/4 (6-19) W x 18-24 (457-610) L	120 V (AC)	6	1	60 Hz	5 (2.3)	19 (483)	5.5 (140)

Additional Specifications: Maximum 2,520 SFPM (768 SMPM)

Dynaflex® II Contact Arms

For Air and Electric Models – 4" to 17" Workable Reach



Optional 40078 Adapter allows use of 24" long belts. Extends reach to 7" when used with standard contact arms

Part Number	Comments	Belt Size (W x L)	Contact Wheel Assembly (includes bearing and shaft)	Platen Pad
11200	<ul style="list-style-type: none"> Work on broad areas Leave in-line scratch Blend spot welds 	1/2" x 18"	11088 5/8" dia. x 3/8" wide, rubber	11025 1/2" wide; Soft
11201	<ul style="list-style-type: none"> 45 PSIG maximum Enter channels as small as 7/16" 	1/2" x 18"	11068 5/16" dia. x 3/8" wide, steel	11027 1/2" wide; Thin
11202	<ul style="list-style-type: none"> Enter 5/16" x 3/4" openings 	1/4" x 18"	11074 5/8" dia. x 1/8" wide, rubber	11032 1/4" wide; Soft
11203	<p>Order 11312 for heavy-duty version.</p> <ul style="list-style-type: none"> Standard on Models 40335 and 40590 Grind over contact wheel or platen 	1/2" x 18"	11078 5/8" dia. x 3/8" wide, rubber	11025 1/2" wide; Soft
11204, 11305	<ul style="list-style-type: none"> Unique offset design Strap polishing is easy with this arm 	1/8", 1/4" or 1/2" x 18"	11204: 11080 Wheel, 1" dia. x 3/8" wide, 70 duro 11305: 11093 Wheel, 1" dia. x 3/8" wide, 40 duro (Both wheels radiused rubber)	None
11206	<p>Order 11326 for heavy-duty version.</p> <ul style="list-style-type: none"> Standard on Models 40320 and 40330 	5/8" or 3/4" x 18"	11282 3/4" dia. x 5/8" wide, rubber	11109 3/4" wide; Hard
11220, 11300, 11301, 11341	<ul style="list-style-type: none"> 45 PSIG maximum Offset design and miniature contact wheels 2" strap polish in offset area; polish turbine blades and other contours 	11220: 5/8" or 3/4" x 18" All Others: 1/2" x 18"	11220: 11352 5/16" dia. x 5/8" wide, steel 11300: 11332 1/4" dia. x 3/8" wide, steel 11301: 11068 5/16" dia. x 3/8" wide, steel 11341: 11342 5/16" dia. x 3/8" wide, rubber	None None None None
11280	<ul style="list-style-type: none"> Grind corners, enter grooves, strap polish "V" shape wheel 	1/8" or 1/4" x 18"	11086 1" dia. x 3/8" wide, urethane, tapered	None
11286	<ul style="list-style-type: none"> 11024 Steel Platen available 6-3/4" workable reach 	1/2" x 24"	11078 5/8" dia. x 3/8" wide, rubber	11025 1/2" wide; Soft
11287	<ul style="list-style-type: none"> Standard on Model 40326 Grind on wheel or platen 5-1/4" reach 	5/8" or 3/4" x 20-1/2"	11282 3/4" x 5/8" wide, rubber	11109 3/4" wide; Hard

Dynafile® II Contact Arms

For Air and Electric Models – 4" to 17" Workable Reach



Optional 40078 Adapter allows use of 24" long belts. Extends reach to 7" when used with standard contact arms

Part Number	Comments	Belt Size (W x L)	Contact Wheel Assembly (includes bearing and shaft)	Platen Pad
11304 "The Banana Arm" 	<ul style="list-style-type: none"> Work on broad areas; levels in-line scratch; blend stainless 	1/2" x 18"	11078 5/8" dia. x 3/8" wide, rubber	11132 1/2" wide
11312  	<ul style="list-style-type: none"> Heavy-duty steel Grind over contact wheel or platen 	1/2" x 18"	11078 5/8" dia. x 3/8" wide, rubber	11025 1/2" wide; Soft
11314  	<ul style="list-style-type: none"> 45 PSIG maximum File round openings as small as 7/16" 	1/4" x 18"	11066 5/16" dia. x 1/8" wide, steel	11034 1/4" wide; Soft
11320 Offset Arm  	<ul style="list-style-type: none"> For flat grinding using platen at or near corners and edges of large radius round Contact wheel is offset to prevent gouging 	1/2" x 18"	5/8" dia. x 3/8" wide, rubber	11026 1/2" wide; Hard
11321  	<ul style="list-style-type: none"> 45 PSIG maximum Work on contact wheel or platen pad 	1/2" x 18"	11070 7/16" dia. x 3/8" wide, rubber	11025 1/2" wide; Soft
11322 	<ul style="list-style-type: none"> Guide-cut Removes raised material within .020" or less without undercutting 	1/2" x 18" 60 to 80 grit	11090 5/8" dia. x 3/8" wide, rubber	None
11329 	<ul style="list-style-type: none"> Extra length arm 17" workable reach 	1/2" x 44"	11078 5/8" dia. x 3/8" wide, rubber	11025 1/2" wide; Soft
11330  	<ul style="list-style-type: none"> Enter 1/2" x 1/2" openings 	1/4" x 18"	11072 7/16" dia. x 1/8" wide, brass	11034 1/4" wide; Thin
11337  	<ul style="list-style-type: none"> Enter channels as narrow as 9/16" 	1/2" x 18"	11076 7/16" dia. x 3/8" wide, steel	11027 1/2" wide; Thin
11350 	<ul style="list-style-type: none"> 45 PSIG maximum Excellent for cleaning oxide off electrical bus bars Arm has a 12" workable reach 	3/4" x 34"	11352 5/16" dia. x 5/8" wide, steel	Optional 3/4" wide
11360 	<ul style="list-style-type: none"> Unique offset design Grind over contact wheels or strap polish 	1/2" x 18"	11078 5/8" dia. x 3/8" wide, rubber	None

Mini-Dynaflex® II

Air-Powered Abrasive Belt Tool

Ideal for Strap Polishing and Working in Narrow Openings

- Lightweight ergonomic design handle features 7° offset. Multi-position grinding head pivots 360°.
- Belt guard easily detaches for quick abrasive change; simple belt tracking adjustment knob.

Model 15003 For 12" Long Belts

- Tool includes 15026 Contact Arm (see page 15), for 1/2" wide x 12" long abrasive belts and 15118 Drive Wheel.

15006 Versatility Kit

- 15003 Tool (15118 Drive Wheel) with 15026 Contact Arm for 1/2" wide x 12" long abrasive belts. Also includes 15028 and 15030 Arms (see page 15).
- Includes 01644 Threaded Collet Insert to easily convert tool to 1/4" Die Grinder.
- Assorted coated and non-woven nylon belts; durable carrying case.

FOR ABRASIVE BELTS

1/8", 1/4", 1/2" wide x 12" long
(3 mm, 6 mm, 13 mm x 305 mm)



• 40378 Rubber Drive Wheel may be ordered separately, for efficient use with optional non-woven nylon belts.



• For added versatility, tool can be easily converted to Die Grinder with optional 01644 (1/4") Threaded Collet Insert.

- Mini-Dynaflex® II now includes **Swiveling Belt Guard**, allowing easy abrasive belt change without removing the guard!

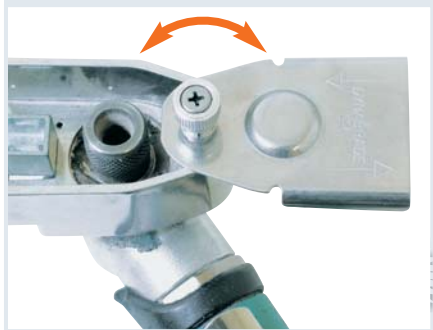

Effective for blending stainless steel and grinding right angle welds.



Clean and finish using non-woven nylon belts.

Model Number	Motor hp (W)	Motor RPM	Sound Level	Abrasive Belt Size Inch (mm)	Maximum Air Flow SCFM (LPM)	Max. SFPM (SMPM)	Weight Pound (kg)	Length Inch (mm)	Height Inch (mm)
15003	.4 (298)	25,000	80 dB(A)	1/8-1/2 (3-13) W x 12 (305) L	20 (566)	4,890 (1,486)	1.8 (.8)	11-3/4 (298)	3-1/2 (89)

Additional Specifications: Air Inlet Thread 1/4" NPT • Hose I.D. Size 1/4" (6 mm) • Air Pressure 90 PSIG (6.2 Bar)

Tune-Up Kit: No. 96074

Mini-Dynaflex® II Contact Arms

3" Workable Reach; Exclusive to the Mini-Dynaflex® II



Part Number	Comments	Belt Size (W x L)	Contact Wheel Assembly (includes bearing and shaft)	Platen Pad
15026 	<ul style="list-style-type: none"> • Standard on Model 15003 • Grind corners, enter grooves 	1/2" x 12"	11078 5/8" dia. x 3/8" wide, rubber	11026 1/2" wide; Hard
15027 	<ul style="list-style-type: none"> • Sand on both sides of arm • Enter confined areas as small as 1/4" 	1/4" x 12"	11074 5/8" dia. x 1/8" wide, rubber	11033 1/4" wide; Hard
15025, 15028 	<ul style="list-style-type: none"> • No platen due to offset design • Grind radiuses • Offset for slack polishing 	1/4" or 1/2" x 12"	15025: 11093 Wheel, 1" dia. x 3/8" wide, 40 duro rubber 15028: 11080 Wheel, 1" dia. x 3/8" wide, 70 duro rubber	None
15029 	<ul style="list-style-type: none"> • Grind corners, enter grooves and strap polish 	1/8" x 12"	11086 1" dia. x 3/8" wide, urethane	None
15030 	<ul style="list-style-type: none"> • 45 PSIG maximum • Enter channels as narrow as 7/16" 	1/2" x 12"	11068 5/16" dia. x 3/8" wide, steel	11027 1/2" wide; Thin
15031 	<ul style="list-style-type: none"> • 45 PSIG maximum • Work on contact wheel or platen pad 	1/2" x 13"	11070 7/16" dia. x 3/8" wide, rubber	11027 1/2" wide; Thin
15032 	<ul style="list-style-type: none"> • 45 PSIG maximum • Grind, blend and polish turbine blades 	1/2" x 12"	11332 1/4" dia. x 3/8" wide, steel	None
15033 	<ul style="list-style-type: none"> • 45 PSIG maximum • Grind, polish turbine blades and other contours 	1/4" x 12"	11342 5/16" dia. x 3/8" wide, rubber	None

Dynafite® III

Air-Powered Abrasive Belt Tool

Excellent for Grinding Welds, Blending and Deburring

- Dynafite® III Abrasive Belt Tool offers all the versatility of our world-famous Dynafite® II, while serving up more power (.7 hp / 522 W) for faster material removal.
- Tool includes high-efficiency Rubber Drive Wheel, ideal for use with all abrasive belts.
- Tool grinding head pivots 360°.
- Soft grip handle assembly allows operator to apply additional force to contact wheel. Handle also offers enhanced control and maneuverability.
- Optional safety-lock throttle lever is available.

Model 15300 For 18" Long Belts

- Includes 15350 Contact Arm (see page 19), for 1" wide x 18" long belts.

15302 Versatility Kit

- Includes 15300 Dynafite® III with 15321, 15350 and 15357 Contact Arms (see page 19), plus assortment of abrasive belts, spare 15336 Drive Wheel, wrenches and hex keys, all in durable carrying case.



15350 Contact Arm with serrated wheel allows aggressive removal.

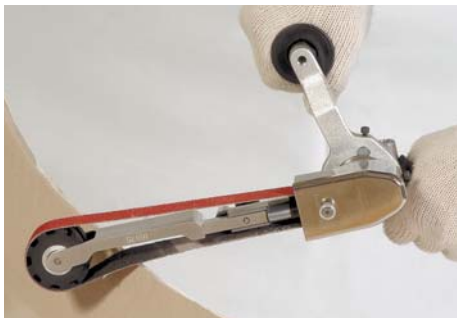

Slack sanding with optional 15375 Arm.

FOR ABRASIVE BELTS
1/4", 1/2", 3/4", 1" wide x 18" long
(6 mm, 13 mm, 19 mm,
25 mm x 457 mm)



TECH TIP Several Dynafite® III Contact Arms serve a dual purpose. These Arms are REVERSIBLE to allow for platen sanding OR strap polishing. (See page 19.)



Model Number	Motor hp (W)	Motor RPM	Sound Level	Abrasive Belt Size Inch (mm)	Maximum Air Flow SCFM (LPM)	Max. SFPM (SMPM)	Weight Pound (kg)	Length Inch (mm)	Height Inch (mm)
15300	.7 (522)	20,000	87 dB(A)	1/4 - 1 (6-25) W x 18 (457) L	32 (906)	4,550 (1,382)	3.5 (1.6)	14-1/4 (362)	4-7/8 (124)

Additional Specifications: Air Inlet Thread 1/4" NPT • Hose I.D. Size 3/8" (10 mm) • Air Pressure 90 PSIG (6.2 Bar)

Tune-Up Kit: No. 96233

Dynaflex® III

Air-Powered Abrasive Belt Tool

FOR ABRASIVE BELTS
 1/4", 1/2", 3/4", 1" wide x 18" long
 (6 mm, 13 mm, 19 mm,
 25 mm x 457 mm)

Lightweight Models with Popular Contact Arms

- Dynaflex® III Abrasive Belt Tool offers all the versatility of our world-famous Dynaflex® II, while serving up more power (.7 hp / 522 W) for faster material removal.
- Models 15400, 15401 and 15420 do not include side handle, reducing tool weight and allowing greater maneuverability. (53163 side handle is available as an option.)
- All models include high-efficiency Rubber Drive Wheel, ideal for use with all abrasive belts.
- Tool grinding head pivots 180°.

Model 15400 For 18" Long Belts

- Includes 11206 Contact Arm for belts 5/8" or 3/4" wide x 18" long (see page 18).

Model 15401 For 20-1/2" Long Belts

- Includes 11287 Contact Arm for belts 5/8" or 3/4" wide x 20-1/2" long (see page 18).

Model 15360 For 24" Long Belts

- Includes 15368 Contact Arm with extended reach, for belts 1/4" to 1" wide x 24" long (see page 19).
- Extended reach is ideal for use on concave areas of large turbine blades, and many other applications.
- Soft grip handle assembly allows operator to apply additional force to contact wheel. Handle mounts in three positions, providing enhanced control and maneuverability.

Model 15420 For 24" Long Belts

- Includes 11702 Contact Arm with unique 4" diameter wheel (see page 18), for grinding or blending right angle welds and fillet welds. Contact Arm includes hand guide for additional control. Saves time and reduces costs!
- Grinds corner welds with no undercutting.
- Tool accepts belts 24" long, in widths of 1/4" or 1/2".

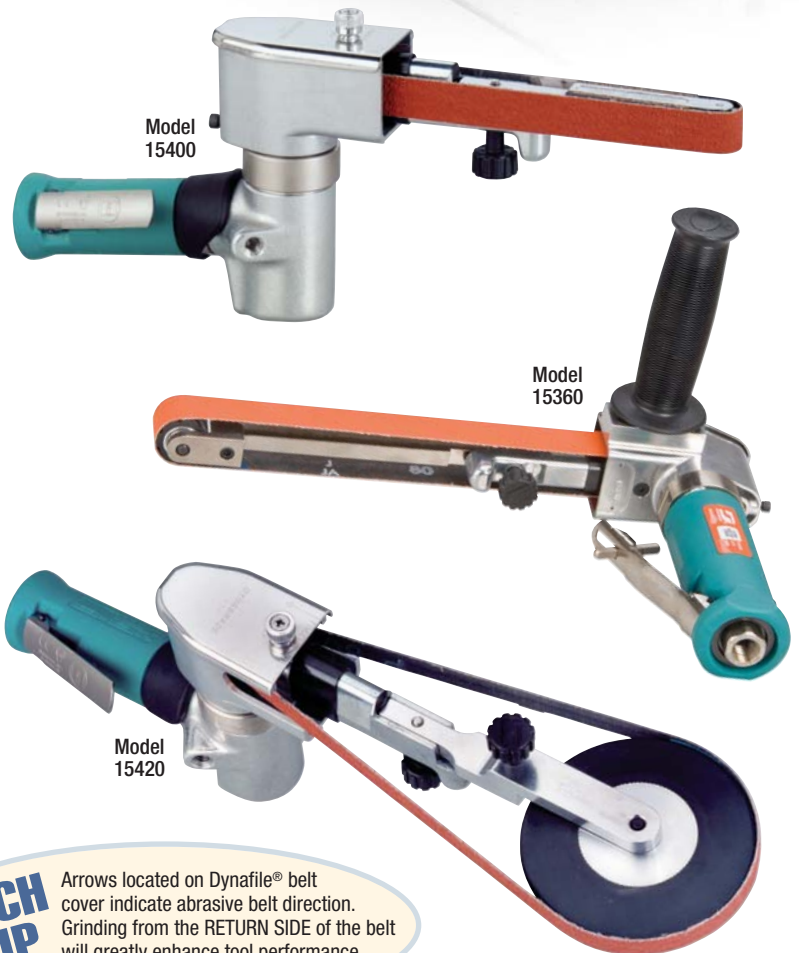

15420 Dynaflex® III includes unique 11702 Contact Arm with hand guide.

TECH TIP Arrows located on Dynaflex® belt cover indicate abrasive belt direction. Grinding from the RETURN SIDE of the belt will greatly enhance tool performance and increase belt life.

Model Number	Motor hp (W)	Motor RPM	Sound Level	Abrasive Belt Size Inch (mm)	Maximum Air Flow SCFM (LPM)	Max. SFPM (SMPM)	Weight Pound (kg)	Length Inch (mm)	Height Inch (mm)
15360	.7 (522)	23,000	91 dB(A)	1 (25) W x 24 (610) L	34 (906)	4,550 (1,382)	3.35 (1.52)	12-3/4 (324)	7-1/8 (181)
15400	.7 (522)	20,000	87 dB(A)	5/8 (16) or 3/4 (19) W x 18 (457) L	32 (906)	4,550 (1,382)	2.5 (1.1)	14-1/4 (362)	4-7/8 (124)
15401	.7 (522)	20,000	87 dB(A)	5/8 (16) or 3/4 (19) W x 20-1/2 (521) L	32 (906)	4,550 (1,382)	2.5 (1.1)	15-1/2 (394)	4-7/8 (124)
15420	.7 (522)	20,000	87 dB(A)	1/4 (6) or 1/2 (13) W x 24 (610) L	32 (906)	4,550 (1,382)	2.5 (1.1)	14 (356)	4-7/8 (124)

Additional Specifications: Air Inlet Thread 1/4" NPT • Hose I.D. Size 3/8" (10 mm) • Air Pressure 90 PSIG (6.2 Bar)
 Tune-Up Kit: No. 96233

Dynaflex® III Contact Arms

4" to 6-3/4" Workable Reach



Part Number	Comments	Belt Size (W x L)	Contact Wheel Assembly (includes bearing and shaft)	Platen Pad
11200 	<ul style="list-style-type: none"> • Work on broad areas • Leave in-line scratch • Blend stainless 	1/2" x 18"	11088 5/8" dia. x 3/8" wide, rubber	11025 1/2" wide; Soft
11203 	<ul style="list-style-type: none"> • Standard on Models 40335 and 40590 • Grind over contact wheel or platen • Order 11312 for heavy-duty, or 11325 for steel platen version 	1/2" x 18"	11078 5/8" dia. x 3/8" wide, rubber	11025 1/2" wide; Soft
11204, 11305 	<ul style="list-style-type: none"> • Unique offset design • Strap polishing is easy with this arm 	1/8", 1/4" or 1/2" x 18"	11204: 11080 Wheel, 1" dia. x 3/8" wide, 70 duro, radiused rubber 11305: 11093 Wheel, 1" dia. x 3/8" wide, 40 duro, radiused rubber	None
11206 	<ul style="list-style-type: none"> • Standard on Models 40320 and 40330 • Order 11326 for heavy-duty steel construction version 	5/8" or 3/4" x 18"	11282 3/4" dia. x 5/8" wide, rubber	11109 3/4" wide; Hard
11286 	<ul style="list-style-type: none"> • 11024 Steel Platen available • 6-3/4" workable reach 	1/2" x 24"	11078 5/8" dia. x 3/8" wide, rubber	11025 1/2" wide; Soft
11287 	<ul style="list-style-type: none"> • Standard on Model 40326 • Grind on wheel or platen • 5-1/4" reach 	5/8" or 3/4" x 20-1/2"	11282 3/4" dia. x 5/8" wide, rubber	11109 3/4" wide; Hard
11320 Offset Arm 	<ul style="list-style-type: none"> • For flat grinding using platen at or near corners and edges of large radius round • Contact wheel is offset to prevent gouging bus bars 	1/2" x 18"	11078 5/8" dia. x 3/8" wide, rubber	11026 1/2" wide; Hard
11702 <p>For use on 15420 Dynaflex® III only (see page 17)</p>	<ul style="list-style-type: none"> • Perfectly designed to reach up to 2" in a channel • Great for use with scalloped edge abrasives, blending weld seams 	1/4" or 1/2" x 24"	11638 70 durometer 4" dia. x 1/2" wide, radiused rubber	None

Dynaflex® III Contact Arms

4" to 6-3/4" Workable Reach



Part Number	Comments	Belt Size (W x L)	Contact Wheel Assembly (includes bearing and shaft)	Platen Pad
15321  	<ul style="list-style-type: none"> For flat grinding using platen pad 	1" x 18"	15320 3/4" dia. x 7/8" wide, rubber	15323 1" wide; Soft
15326  	<ul style="list-style-type: none"> Allows for longer reach Grind using platen pad 	1" x 24"	15320 3/4" dia. x 7/8" wide, rubber	15323 1" wide; Soft
15350  	<ul style="list-style-type: none"> Reversible arm - arm can be flipped to allow for platen sanding or strap polishing Standard with tool 	1" x 18"	15349 90 durometer 2" dia. x 1" wide, rubber	15323 1" wide; Soft
15351  	<ul style="list-style-type: none"> Reversible arm - arm can be flipped to allow for platen sanding or strap polishing 	1" x 18"	15348 70 durometer 2" dia. x 1" wide, rubber	15323 1" wide; Soft
15356  	<ul style="list-style-type: none"> Reversible arm - arm can be flipped to allow for platen sanding or strap polishing 	1" x 18"	15346 40 durometer 2" dia. x 5/8" wide, rubber	15323 1" wide; Soft
15357  	<ul style="list-style-type: none"> Reversible arm - arm can be flipped to allow for platen sanding or strap polishing "V" shape wheel 	1" x 18"	15347 2" dia. x 1" wide, rubber	15323 1" wide; Soft
15368 	<ul style="list-style-type: none"> Standard on Model 15360 Allows for longer reach Grind using wheel surface 	1" x 24"	15359 70 durometer 1" dia. x 1" wide, serrated rubber	None
15375  	<ul style="list-style-type: none"> Great for strap polishing 	1" x 24"	15348 70 durometer 2" dia. x 1" wide, rubber	None

Dynabelter®

Air-Powered Abrasive Belt Tool

For Weld Grinding, Blending and Finishing on Metal and Other Surfaces

- Dynabelter® is ideal for work on ferrous and non-ferrous metals, wood, plastic, stone and composites.
- Uses include grinding cylinders, deburring castings, cleaning welds and fabricating metals.
- Also excellent for polishing tubing, deburring structural steel, finish-dimensioning on lathe work and blending inside corners.
- Safety-lock lever throttle included on all models.

FOR ABRASIVE BELTS

1", 2" wide x 30" long
(25 mm, 51 mm x 762 mm)

Model 11475 Standard Duty, .7 hp

- Accepts 1" wide x 30" long abrasive belts.
- Adjustable speed; removable side handle.
- Includes 11681 Contact Arm Assembly (see page 22).
- Ideal for use with 1/4" Dynaswivel® (see page 29), and 95676 Coupler/Plug Assembly (see page 31).

Model 11476 Heavy-Duty, 1.2 hp

- Accepts 1" wide x 30" long abrasive belts.
- Includes 11681 Contact Arm Assembly (see page 22), and top control handle.
- Ideal for use with 3/8" Dynaswivel® (see page 29), and 98265 Coupler/Plug Assembly (see page 31).

Model 11477 Extra Heavy-Duty, 2.0 hp

- Accepts 2" wide x 30" long abrasive belts.
- Includes pressure bar with top control handle.
- Includes 11870 Contact Arm Assembly (see page 22).
- 11871 Contact Arm with 4" dia. contact wheel is available for 2" wide x 60" long belts, providing a 20" workable reach. Optional 11891 Platen is available for 11871 Arm.
- Ideal for use with 1/2" Dynaswivel® (see page 29), and 98273 Coupler/Plug Assembly (see page 31).



Model 11475



Model 11476

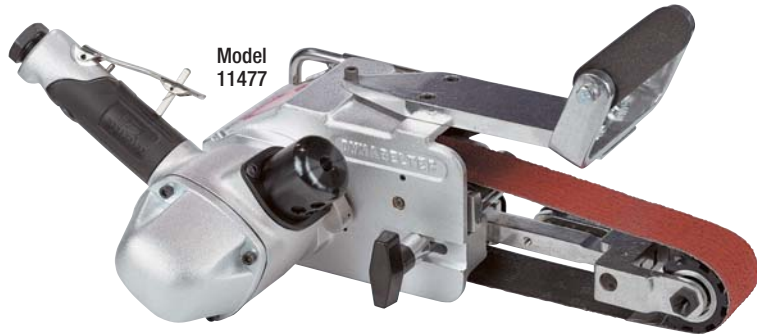

Model 11477



Model 11476 grinds weld seam and leaves in-line scratch pattern.

Model Number	Motor hp (W)	Motor RPM	Sound Level	Abrasive Belt Size Inch (mm)	Air Inlet Thread	Maximum Air Flow SCFM (LPM)	Max. SFPM (SMPM)	Weight Pound (kg)	Length Inch (mm)	Height Inch (mm)
11475	0.7 (522)	18,000	92 dB(A)	1/4-1 (6-25) W x 30 (762) L	1/4" NPT	32 (906)	5,890 (1,789)	7.5 (3.4)	21 (533)	7-1/4 (184)
11476	1.2 (895)	13,000	89 dB(A)	1/4-1 (6-25) W x 30 (762) L	3/8" NPT	58 (1,643)	4,250 (1,295)	10 (4.5)	21 (533)	7-1/4 (184)
11477	2.0 (1,492)	7,200	82 dB(A)	1-2 (25-51) W x 30 (762) L	1/2" NPT	70 (1,982)	4,700 (1,432)	14 (6.4)	21-1/2 (546)	7-3/4 (197)

Additional Specifications: Hose I.D. Size 1/2" (13 mm) • Air Pressure 90 PSIG (6.2 Bar)

Tune-Up Kits: Model 11475 – No. 96045; Model 11476 – No. 96011; Model 11477 – No. 96259

Dynabelter® Accu-Grinder

**Air-Powered Abrasive Belt Tool
with Adjust-A-Wheel**

Grinds Welds Flat, Without Undercutting

- Efficiently removes excess weld material and leaves a narrow "in-line" scratch pattern. This model takes the guesswork out of weld grinding, and prevents undercutting!

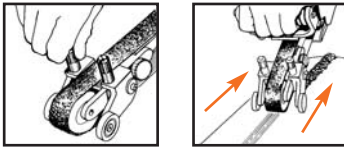

- Adjustable guide tires control the depth of abrasive belt cut. Simple twist-knobs adjust depth of cut. Allows controlled grinding on flats, contours and inside/outside of pipes and tanks.

Model 11486 Heavy-Duty, 1.2 hp

- Includes 11717 Adjust-A-Wheel Contact Arm with 90-durometer standard serrated Contact Wheel, 2" diameter x 1" wide (see page 22).

Work on Longitudinal Welds:

- I.D. – 12" diameter pipe or larger.
- O.D. – 8" diameter pipe or larger.



FOR ABRASIVE BELTS

1" wide x 30" long
(25 mm x 762 mm)



Model
11486

Model Number	Motor hp (W)	Motor RPM	Sound Level	Abrasive Belt Size Inch (mm)	Maximum Air Flow SCFM (LPM)	Max. SFPM (SMPM)	Air Inlet Thread	Weight Pound (kg)	Length Inch (mm)	Height Inch (mm)
11486	1.2 (895)	13,000	89 dB(A)	1 (25) W x 30 (762) L	58 (1,643)	4,220 (1,282)	3/8" NPT	9.0 (4.1)	22 (559)	7 (178)

Additional Specifications: Hose I.D. Size 1/2" (13 mm) • Air Pressure 90 PSIG (6.2 Bar)
Tune-Up Kit: No. 96011

Dynabelter® Accessories

Dynabelter® Adapter

11739 Adapter

- Dynaflex® Contact Arms (see pg. 7), can be mounted on 11475 and 11476 Dynabelter® models with optional 11739 Adapter.
- Allows for work in small areas using 30" belts (8" reach).



11739 Adapter

Dynabelter® Contact Arm Extenders

- Allows for longer abrasive belts! The Dynabelter® uses standard 30" long abrasive belts, however, these extenders allow Contact Arms to use longer abrasive belts.
- Extenders can only be used with Dynabelter® Contact Arms.

11656 Extender For 42" Belts (13" Reach)

11657 Extender For 54" Belts (19" Reach)

11679 Extender For 60" Belts (21" Reach)

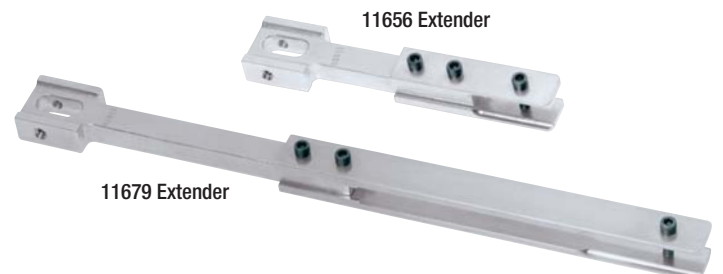





11656 Extender

11679 Extender

Dynabelter® Contact Arms

Variety of Contact Wheels and Wheel Assemblies



Part Number	Comments	Belt Size (W x L)	Contact Wheel Assembly (includes bearing and shaft)	Platen Pad
11681	 <ul style="list-style-type: none"> • Standard on Models 11475 and 11476 • 7-1/2" workable reach • Grind using platen pad 	1" x 30"	11650 (Included) 70 durometer standard serrated serrated rubber, 2" dia. x 1" wide 11618 90 durometer standard serrated rubber, 2" dia. x 1" wide	11605 1" x 2-1/2"; Hard
11663	 <ul style="list-style-type: none"> • Grind, deburr, polish over platen • 7-1/2 workable reach 	1" x 30"	11616 80 durometer smooth rubber, 1" dia. x 1" wide	11605 1" x 2-1/2"; Hard
11668	 <ul style="list-style-type: none"> • Wheel mount pivots to maintain surface contact • Work on broad areas, blend stainless • Leaves "in-line" scratch pattern • 6" workable reach 	1" x 30"	11616 Two wheels, 80 durometer smooth rubber, 1" dia. x 1" wide	11605 1" x 1-7/8"; Hard
11677	 <ul style="list-style-type: none"> • Grind, blend, polish welds • Strap polish using slack of belt • 7" workable reach 	1" x 30"	11620 40 durometer smooth rubber, (80 durometer available, 11622) 4" dia. x 1"	None
11682	 <ul style="list-style-type: none"> • Grind, deburr fillet welds, inside corners • 7" workable reach 	1/2" or 1" wide x 30" long	11638 70 durometer radiused rubber, 4" dia. x 1/2" wide	None
11684	 <ul style="list-style-type: none"> • Polish contours without gouging workpiece • Ideal for stainless pipe • 7" workable reach 	1" x 30"	11642 40 durometer serrated rubber, (80 durometer wheel – 11892; 90 durometer wheel – 11888) 4" dia. x 5/8" wide	None
11717	 <ul style="list-style-type: none"> • For best results when ordering 11717 Contact Arm for Dynabelter Model 11476 add: <ul style="list-style-type: none"> - 11544 Pressure Bar - Three 95150 Mounting Screws - 11794 Back Wheel Assembly 	1" x 30"	11618 90 durometer standard serrated urethane 2" dia. x 1" wide	None
11870	 <ul style="list-style-type: none"> • Standard on Model 11477 • 2" dia. x 2" wide urethane wheel assemblies are only for extra heavy-duty tools • 7" workable reach 	2" x 30"	2" dia. x 2" wide rubber assemblies available: 11847: (Included) 70 durometer standard serration 11849: 70 durometer scoop serration 11851: 90 durometer standard serration 11853: 90 durometer scoop serration	Optional 11659 2" x 2-1/2"

Dynangle

Air-Powered Abrasive Belt Tool

Powerful Direct-Drive Air Motor with Adjustable Speed

- Compact tool is ideal for work in tight spots; handle is multi-positional. Perfect for blending radiuses and adding grain to stainless steel sinks.
- Interchangeable Contact Arms match specific applications on stainless steel (see below). Also ideal for refinishing drilling screws and pump screws.

Model 14200

- Includes 14266 Contact Arm and 11605 Hard/Cork Dynapad® Platen Pad.



Model 14200



FOR ABRASIVE BELTS

1" wide x 18" long
(25 mm x 457 mm)

TECH TIP

When working on spot welds, lower platen to avoid gouging of work surface with contact wheel.

Model Number	Motor hp (W)	Motor RPM	Sound Level	Abrasive Belt Size Inch (mm)	Maximum Air Flow SCFM (LPM)	Max. SFPM (SMPM)	Weight Pound (kg)	Length Inch (mm)	Height Inch (mm)
14200	.7 (522)	20,000	92 dB(A)	1 (25) W x 18 (457) L	36 (1,020)	6,540 (1,987)	4.8 (2.2)	11 (279)	5 (127)

Additional Specifications: Air Inlet Thread 1/4" NPT • Hose I.D. Size 3/8" (10 mm) • Air Pressure 90 PSIG (6.2 Bar)

Tune-Up Kit: No. 96045

Dynangle Contact Arms

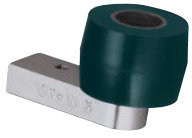
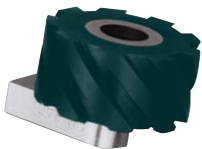
Part Number	Belt Size (W x L)	Contact Wheel Assembly (includes bearing and shaft)	Wheel Material	Surface	Use
14261 	1" x 18"	14251 1" dia. x 1" wide	70 durometer urethane	Smooth	1/2" radiused corner
14263 	1" x 18"	14253 1-1/2" dia. x 1" wide	70 durometer urethane	Smooth	3/4" radiused corner
14266 	1" x 18"	14256 2" dia. x 1" wide	70 durometer rubber	Standard serrated	1" radiused corner

Dynangle II

Air-Powered Abrasive Belt Tool

Polish, Grind Contours and Flats

- Surface conditions stainless steel and most other metals. Also used on wood, plastic, fiberglass and composites. Blends and finishes solder seams.
- Built-in abrasive belt guard; fast belt change.
- Safety-lock lever-throttle; hanger brackets included for optional overhead suspension.

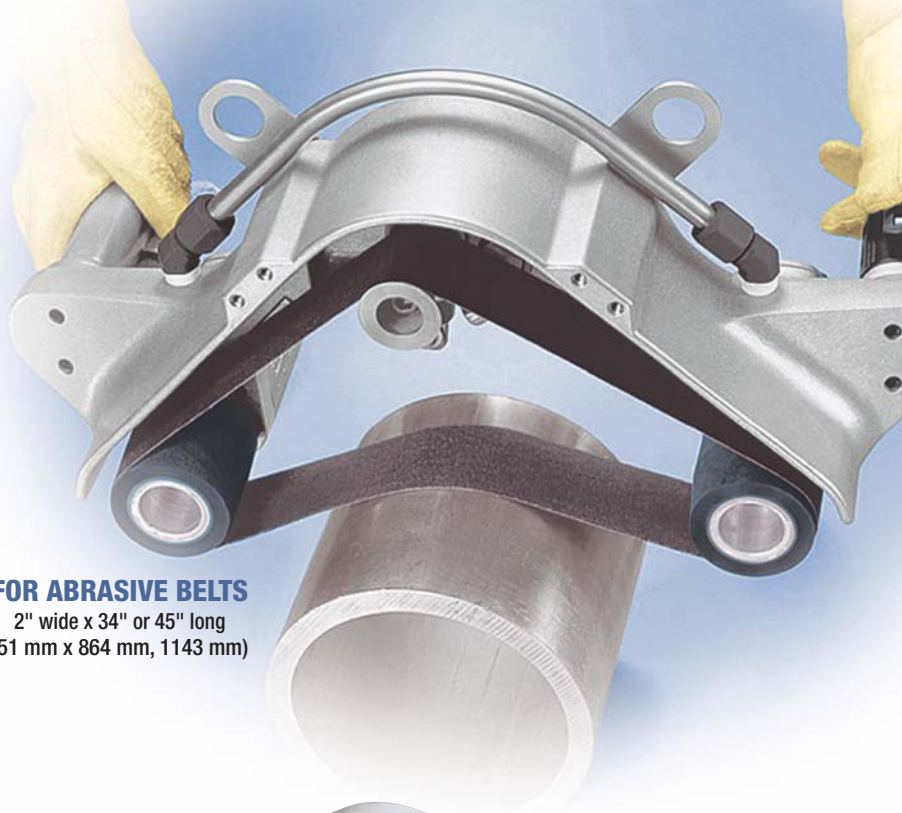
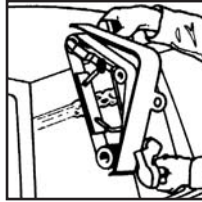

FOR ABRASIVE BELTS

2" wide x 34" or 45" long
(51 mm x 864 mm, 1143 mm)

Model 14300 Single Motor

- Uses 2" x 34" belts; belts spans 11-1/2" for "slack polishing" up to 36" diameter pipe.
- 14350 Conversion Kit available to upgrade single motor model to a dual motor model at a later date, if desired.

NOTE: For grinding with a platen pad, dual motor models are recommended.

Model 14303

Heavy-Duty "Dual Motor" with Platen

- Heavy-duty "dual motor" for extra power.
- Uses 2" x 34" belts; belts spans 11-1/2" for "slack polishing" up to 36" diameter pipe.
- Includes 2" wide x 6" long platen which is easily removed for strap polishing.

Model 14306

Heavy-Duty "Dual Motor" with Platen

- Heavy-duty "dual motor" for extra power.
- Uses 2" x 45" belts; belts spans 17" for polishing pipe up to 48" diameter.
- Includes 2" wide x 6" long platen which is easily removed for strap polishing.



Model 14300



Model 14303

TECH TIPS

For optimum use of Dynangle II, it is critical that proper air flow is maintained. To maintain belt tension, use abrasive belts with low-flex or low-stretch backing.

Model Number	Motor hp (W)	Motor RPM	Sound Level	Abrasive Belt Size Inch (mm)	Maximum Air Flow SCFM (LPM)	Max. SFPM (SMPM)	Weight Pound (kg)	Length Inch (mm)	Height Inch (mm)
14300	1.2 (895)	13,000	85 dB(A)	2 (51) W x 34 (864) L	53 (1,501)	8,500 (2,591)	15.1 (6.9)	18-7/8 (479)	8-1/2 (216)
14303	2.4 (1,790)	13,000	85 dB(A)	2 (51) W x 34 (864) L	106 (3,002)	8,500 (2,591)	18.7 (8.2)	18-7/8 (479)	9-9/16 (243)
14306	2.4 (1,790)	13,000	90 dB(A)	2 (51)W x 45 (1,143) L	106 (3,002)	8,500 (2,591)	19.2 (8.7)	22-7/8 (581)	9-1/2 (241)

Additional Specifications: Air Inlet Thread 1/2" NPT • Hose Size 1/2" (13 mm) • Air Pressure 90 PSIG (6.2 Bar)
Tune-Up Kit: No. 96011 (Dual motor models require two Tune-Up Kits)

“Take-About” Sander

Air-Powered Abrasive Belt Tool

FOR ABRASIVE BELTS

3" wide x 24" long
(76 mm x 610 mm)

Ideal for Surface Leveling, Graining and Finishing

Model 52900

- Heavy-duty 1.3 hp sander (3,500 RPM) powers 3" x 24" abrasive belts, for aggressive material removal on metal and wood.
- Toggle switch offers simple one-step belt tensioning.
- Pistol-grip handle and top control knob allow enhanced operator control. Easily adjustable tracking of abrasive belt.
- Tool works well with non-woven nylon belts.
- Safety-lock throttle lever is included.



Model 52900

TECH TIP

Dynaswivel® air line connector is ideal for use with most air tools. The Dynaswivel® improves tool maneuverability, minimizes operator fatigue and extends hose life (see page 29).



Model Number	Motor hp (W)	Motor RPM	Sound Level	Abrasive Belt Size Inch (mm)	Maximum Air Flow SCFM (LPM)	Max. S.FPM (SMPM)	Air Inlet Thread	Weight Pound (kg)	Length Inch (mm)	Height Inch (mm)
52900	1.3 (969)	3,500	88 dB(A)	3 (76) W x 24 (610) L	50 (1,416)	2,000 (610)	3/8" NPT	12.5 (5.7)	13-1/4 (337)	7-1/8 (181)

Additional Specifications: Air Pressure 90 PSIG (6.2 Bar) • Hose I.D. Size 1/2" (13 mm)

Contact Arm Platen Pads

Provide Belt Support on Dynabrade Abrasive Belt Tools

Soft Platen Pads • Top facing • Sponge base • Pressure sensitive adhesive

Part Number	For Use on These Tools	Width	Length	Thickness	Package Quantity
11032	Dynafile®, Dynafile® II	1/4"	7"	1/8"	5
11025	Dynafile®, Dynafile® II, Dynafile® III	1/2"	7"	1/8"	5
11119	Dynafile® II	3/4"	7"	1/8"	5
15323	Dynafile® III	1"	2"	1/8"	5

For work on contoured pieces

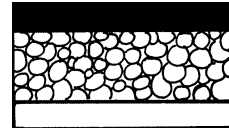

1/8" (3 mm)

11025 Platen Pad affixed to 11218 Dynafile® Contact Arm



Hard Platen Pads • Top facing • Cork base • Pressure sensitive adhesive

Part Number	For Use on These Tools	Width	Length	Thickness	Package Quantity
11033	Mini-Dynafile® II	1/4"	7"	1/8"	5
11026	Dynafile®, Dynafile® II, Mini-Dynafile® II, Dynafile® III	1/2"	7"	1/8"	5
11109	Dynafile® II, Dynafile® III	3/4"	7"	1/8"	5
15324	Dynafile® III	1"	2"	1/8"	5

For heavy deburring and polishing



1/8" (3 mm)

Thin Platen Pads • Top facing • Pressure sensitive adhesive

Part Number	For Use on These Tools	Width	Length	Thickness	Package Quantity
11034	Dynafile®, Dynafile® II	1/4"	7"	1/32"	5
11027	Dynafile®, Dynafile® II, Mini-Dynafile® II	1/2"	7"	1/32"	5
11129	Dynafile® II	3/4"	7"	1/32"	5

For use with Contact Arms with small diameter Contact Wheels (such as 11212)

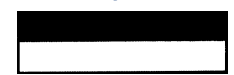

1/32" (.8 mm)

Pneumatic Wheels

For Use on Dynastraight® and Dynisher Tools

- When fitted with an abrasive belt and inflated to the desired firmness, our Pneumatic Wheels are ideal for countless grinding and finishing applications.
- Dynabrade Pneumatic Wheels support coated abrasive and non-woven nylon belts for use on metal, wood, plastic, ceramic, fiberglass and composites.

Pneumatic Wheels

Standard Wheels

- For general finishing jobs.
- 1/8" thick natural, 65 durometer rubber.

Heavy Duty Wheels

- When you need a more aggressive wheel for more stock removal.
- 1/4" thick natural, 65 durometer rubber.
- Extremely durable - when used properly wheel is very resistant to gouging.

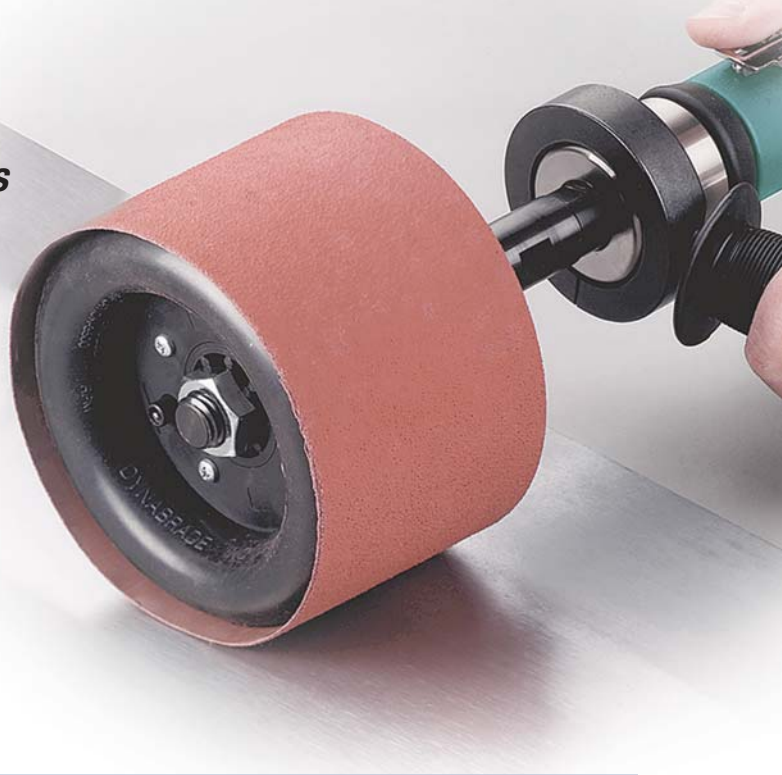

Wheel Hubs

Composite Hub

- Molded; lightweight design.
- Available with standard construction rubber wheels only.



Heavy Duty Aluminum Hub

- Precision machined for balance run-out and thread quality.
- Easily replace rubber wheel.
- Available with both wheel construction types.



Universal Arbor

- Pneumatic wheels with a universal arbor include three reducer bushings (1/2", 5/8", 3/4") to greatly increase the wheel compatibility.



Inflation Devices and Accessories

Wheel Inflation Tool

Part No. 94465

- Controlled inflation for valve assemblies that are flush with the hub surface.
- 1/4" female NPT.
- 95633 Nozzle replacement available.



Air Pump Assembly

Part No. 98091

- Easy slide pump; no compressor needed.



Dynastraight® Wheel Shields

Part No. 13032

- For wheels up to 8" dia. x 2" wide.
- Built-in handle.



Part No. 13033

- For wheels up to 5" diameter.
- Built-in handle.



Dynacushion® Pneumatic Wheel Kits

Part No. 94478

- Includes: 94473 Dynacushion® Pneumatic Wheel (5" dia. x 3-1/2" wide, composite hub, 3/4" bore), coarse non-woven nylon belt and 80-grit DynaCut belt.



Part No. 94479

- Includes: 94472 Dynacushion® Pneumatic Wheel (5" dia. x 3-1/2" wide, composite hub, 5/8"-11 thread), coarse non-woven nylon belt and 80-grit DynaCut belt.

DynaWheel Pneumatic Wheels

For Light Grinding and Deburring with Dynastraight® and Dynisher Tools

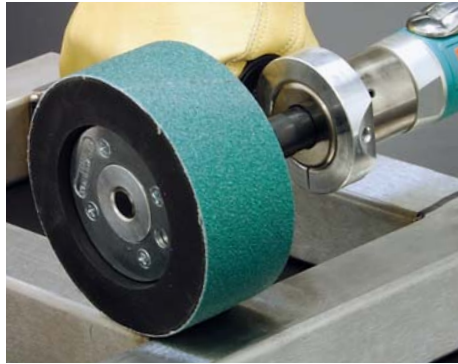

For full information on Dynastraight® and Dynisher tools, please refer to Dynabrade General Catalog.

Each DynaWheel includes 98130 Low Pressure Air Chuck!

- Controlled inflation for hard-to-reach valve assemblies. 1/4" female NPT.



	Dimensions Diameter x Width	Part Number	Hub Composition	Arbor Hole	Wheel Part Number	Wheel Type	Belt Size Width x Length	Maximum RPM	Recommended Dynabrade Tools
	5" x 1"	92921	Aluminum	5/8" - 11 Thread	92908	Heavy Duty	1" x 15-1/2"	4,500	13214, 13523
		92922	Composite	5/8" - 11 Thread					
		92923	Aluminum	Universal 1/2", 5/8" or 3/4" Bore					1/2": 13206, 13507
		92924	Composite	Universal 1/2", 5/8" or 3/4" Bore					
	5" x 1-1/2"	92867	Aluminum	5/8"-11 Thread	92665	Heavy Duty	1-1/2" x 15-1/2"	4,500	13214, 13523
		92868	Composite	5/8"-11 Thread					
		92928	Aluminum	Universal 1/2", 5/8" or 3/4" Bore					1/2": 13206, 13507
		92929	Composite	Universal 1/2", 5/8" or 3/4" Bore					
	5" x 2"	92931	Aluminum	5/8"-11 Thread	92666	Heavy Duty	2" x 15-1/2"	4,500	13214, 13523
		92932	Composite	5/8"-11 Thread					
		92933	Aluminum	Universal 1/2", 5/8" or 3/4" Bore					1/2": 13206, 13507
		92934	Composite	Universal 1/2", 5/8" or 3/4" Bore					

NOTE: Speed of tool must not exceed maximum operating speed of accessory.

Dynacushion® Pneumatic Wheels

For Polishing and Blending with Dynastraight® and Dynisher Tools

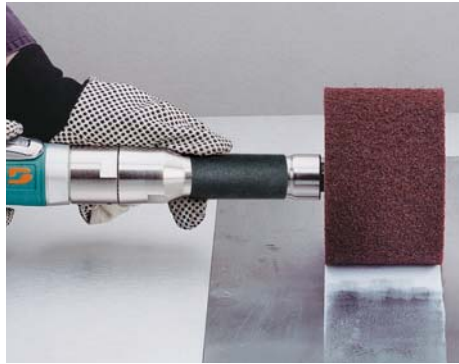

For full information on Dynastraight® and Dynisher tools, please refer to Dynabrade General Catalog.

Each Dynacushion® Wheel includes 98130 Low Pressure Air Chuck!

- Controlled inflation for hard-to-reach valve assemblies. 1/4" female NPT.



	Dimensions Dia. x W	Part No.	Hub Composition	Arbor Hole	Wheel Part No.	Wheel Type	Belt Size W x L	Max. RPM	Recommended Dynabrade Tools
	2-1/4" x 3"	92858	Aluminum	1/2"-13 Thread	94433	Standard	3" x 7-3/8"	9,000	Not applicable
		94432		5/8"-11 Thread					13204, 13505, 13509, 13515, 13519, 13520
	3" x 2-1/4"	92846	Aluminum	1/2"-13 Thread	92643	Standard	2-1/4" x 9-3/4"	7,000	Not applicable
		92847		5/8"-11 Thread	92644	Heavy Duty			13204/205/209, 13515/519/520
		92848		1/2"-13 Thread					Not applicable
		92849		5/8"-11 Thread	13204/205/209, 13515/519/520				
	3-1/4" x 3"	92824	Aluminum	1/2"-13 Thread	92646	Standard	3" x 10-11/16"	7,000	Not applicable
		92825		5/8"-11 Thread	92647	Heavy Duty			13204, 13505, 13515, 13520
		92827		1/2"-13 Thread					Not applicable
		92828	5/8"-11 Thread	94500	Standard	13204, 13505, 13515, 13520			
		94507	5/8" Bore			13101/102, 13202/205/207, 13300, 13503/506/508/516/518			
		94508	5/8"-11 Thread			13204, 13505, 13515, 13520			
	90 mm x 100 mm	92863	Aluminum	19 mm w/ 6 mm Slot	92651	Standard	100 mm x 289 mm	7,000	Not applicable
	5" x 2-3/4"	92811	Aluminum	5/8"-11 Thread	94482	Standard	2-3/4" x 15-1/2"	3,500	13204, 13505/515/521/531
		94492	Composite	5/8"-11 Thread					1/2": 13206, 13507
		92935	Aluminum	Universal 1/2", 5/8" or 3/4" Bore					5/8": 13207, 13508
		92936	Composite	Universal 1/2", 5/8" or 3/4" Bore					
	5" x 3-1/2"	92801	Aluminum	5/8"-11 Thread	94481	Standard	3-1/2" x 15-1/2"	3,500	13204, 13505, 13515, 13521, 13531
		94472	Composite	5/8"-11 Thread	92656	Heavy Duty			Not applicable
		92805	Aluminum	M14 x 2 Thread	94481	Standard			1/2": 13206, 13507
		92803	Aluminum	Universal 1/2", 5/8" or 3/4" Bore					
		92937	Aluminum	Universal 1/2", 5/8" or 3/4" Bore	94481	Standard			5/8": 13207, 13508
		92938	Composite	Universal 1/2", 5/8" or 3/4" Bore					

NOTE: Speed of tool must not exceed maximum operating speed of accessory.

Dynaswivel® Air Line Connectors

Never Fight an Air Hose Again! For Use with Most Air Tools

THE PROBLEM

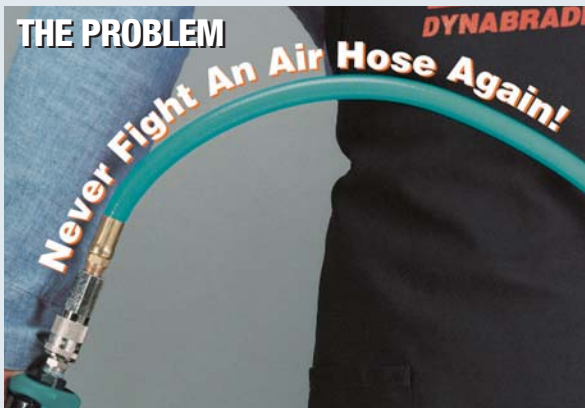

THE SOLUTION



- The Dynaswivel® is a “universal-joint” that connects portable air tools to an air line.
- It improves tool maneuverability, minimizes operator fatigue and extends hose life.
- Patented; works great on air tools or paint guns.

Non-Marring Composite Construction

Double Pivot

- Swivels 360° AT TWO PIVOT POINTS allowing the air hose to drop directly to the floor while providing superb tool handling.



Double Pivot, Flow Control

- Swivels 360° AT TWO PIVOT POINTS allowing the air hose to drop directly to the floor while providing superb tool handling.
- Finger-tip air-flow control dial.



Part Number	Thread Size	Flow Control	Air Flow Range SCFM (LPM)	Weight oz. (kg)
94300*	1/4" NPT	No	up to 33 (935)	2.15 (0.06)
94407*	1/4" NPT	Yes	up to 46 (1303)	2.40 (0.08)

Aluminum and Stainless Steel Construction

Single Pivot

- Right angle “single-pivot” swivels 360° at one location.
- Designed to permit air hose to extend horizontally away from tool while allowing 360° tool maneuverability.
- Great for stationary equipment.



Part Number	Thread Size	Flow Control	Air Flow Range SCFM (LPM)	Weight lb. (kg)
95590**	1/4" NPT	No	up to 25 (708)	0.11 (0.05)
95591**	3/8" NPT	No	26-45 (736-1275)	0.26 (0.12)
95592**	1/2" NPT	No	46-65 (1303-1841)	0.46 (0.21)

Aluminum and Stainless Steel Construction

Double Pivot

- Swivels 360° AT TWO PIVOT POINTS allowing the air hose to drop directly to the floor while providing superb tool handling.



Double Pivot, Flow Control

- Swivels 360° AT TWO PIVOT POINTS allowing the air hose to drop directly to the floor while providing superb tool handling.
- Finger-tip air-flow control dial.



Part Number	Thread Size	Flow Control	Air Flow Range SCFM (LPM)	Weight lb. (kg)
95852**	1/8" Male x 25 1/4" NPT Female	No	up to 25 (708)	0.18 (0.08)
95460**	1/4" NPT	No	up to 25 (708)	0.20 (0.09)
95734**	1/4" NPT	Yes	up to 25 (708)	0.24 (0.11)
95461**	3/8" NPT	No	26-45 (736-1275)	0.40 (0.18)
95462**	1/2" NPT	No	46-65 (1303-1841)	0.80 (0.36)
95690**	3/4" NPT	No	above 65 (1840)	1.50 (0.68)

96177 Dynaswivel®

Display Pak

- Includes one counter top display box and ten 94300 Dynaswivel® Air Line Fittings.



IMPORTANT: 150 PSIG (10.3 Bar) maximum on all models

***NOTE:** Do not exceed recommended torque value of 28-30 newton meters

****NOTE:** Do not use on percussion tools or in areas of high mechanical abuse

DynaJet In-Line Blow Guns

Clean Off Work Surfaces Without Disconnecting

- Only connect once... permanently mounts between coupler and air hose to purge air line of water and contaminants before starting up air tools.
- Durable aluminum construction, weighs only 2 oz. (0.06 kg).

Part No. 94466 Standard Design

- Provides no restriction of air line pressure.

Part No. 94467 Safety Tip Design

- Reduces line pressure down to 30 PSIG (2 Bar).
- Meets O.S.H.A. requirements of special relief hole in nozzle which limits pressure to 30 PSIG (2 Bar) when dead ended and used on an air line of 150 PSIG (10.3 Bar) or less.

Part Number	Thread Size	Weight kg (lb.)	Recommended Air Flow Range SCFM (LPM)
94466	1/4" Female NPT	0.06 kg	up to 35 SCFM (991 LPM)
94467	1/4" Female NPT	0.06 kg	up to 991 LPM

10.3 Bar (150 PSIG) maximum on all models



94466



94467

Proper Installation for DynaJet Blow Gun Connection

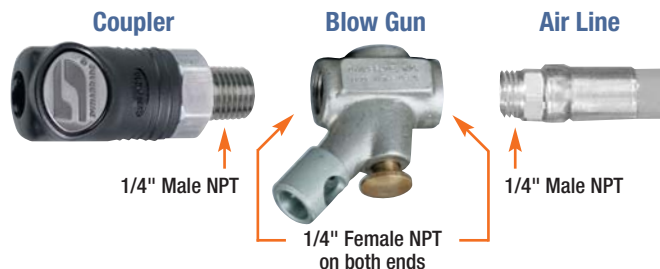

Filter-Regulator-Lubricator

Cost-Effective Maintenance for Air Supply Systems

Filter

- Five-micron filter element is standard.
- Manual push-button drain easily discharges contaminants.

Part Number	Air Inlet Thread
10671	1/2" NPT



10671

Regulator

- Compensation built into unit responds faster to changes in incoming pressure and flow.
- Built-in PSI pressure dial gauge.

Part Number	Air Inlet Thread
10673	1/2" NPT



10673

Lubricator

- Built-in check valve permits tool to be filled with oil without having to turn off air pressure.
- Adjustable oil drop to meter amount of oil into air system.

Part Number	Air Inlet Thread
10675	1/2" NPT



10675

*Each unit includes two bushings for easy conversion to 3/8" NPT.

Additional Specifications: Maximum Operating Pressure 145 PSIG.

Filter-Regulator

- Unit has modular connections with mounting brackets for easy installation.

Part Number	Air Inlet Thread
10677	1/2" NPT



10677

Regulator-Lubricator

- Unit has modular connections with mounting brackets for easy installation.

Part Number	Air Inlet Thread
10679	1/2" NPT



10679

Filter-Regulator-Lubricator

- Unit has modular connections with mounting brackets for easy installation.

Part Number	Air Inlet Thread
10681	1/2" NPT



10681

FRL Flow Characteristics

Flow • SCFM (LPM)	Pressure Drop Across FRL • PSI (Bar)
15 (425)	2.0 (.14)
30 (850)	3.0 (.21)
45 (1274)	6.0 (.41)
60 (1699)	7.0 (.48)
75 (2124)	8.0 (.55)

Couplers and Coupler/Plug Assemblies

Provide Maximum Air Flow to Tools

Steel and Brass Couplers

- Durable nickel-plated steel and brass construction.
- Single action quick-connect by just inserting plug into coupler. Pull back on sleeve of coupler for quick disconnect.

Coupler Body Size	Part Number	Thread Size NPT	Air Flow Range SCFM (LPM)
1/4"	95674	1/4" Female	Up to 74 (2,095)
	95684	1/4" Male	
3/8"	98261	3/8" Female	Up to 138 (3,900)
	98262	3/8" Male	
3/8"	98269	1/2" Female	Up to 138 (3,900)
	98270	1/2" Male	

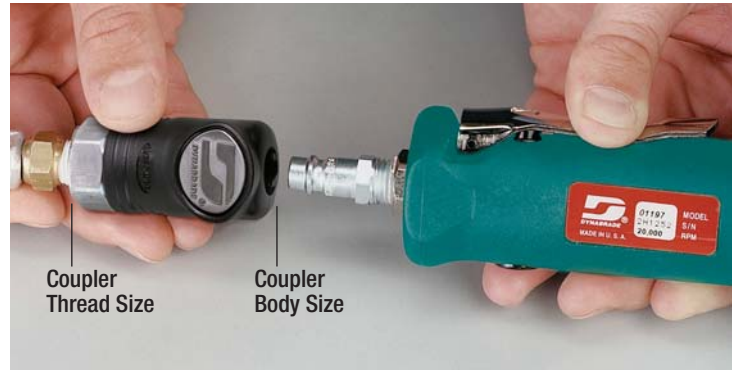

Composite-Style Couplers

- Composite-style design provides maximum air flow to tools.
- Heavy duty construction.
- Easy connect/disconnect by single push-button action.
- Shock-proof, low-vibration, crush-resistant.
- Lightweight 1.4 oz. (0.04 kg), non-marring composite material.



Teal Composite Couplers

- Designed for Industrial Interchange plugs.

Coupler Body Size	Part Number	Color	Thread Size NPT	Air Flow Range SCFM (LPM)
1/4"	94960	Black	1/4" Female	Up to 54 (1,529)
	94980	Black	1/4" Male	
	94920	Teal	1/4" Female	Up to 37 (1,048)
	94921	Teal	1/4" Male	

Safety Couplers

- Unique "Two Step" Safety Disconnect System releases air pressure before tool is disconnected.
- Engineered to minimize air leakage and eliminates "hose whip."
- Aerodynamically-designed valve improves air flow to tool.
- Ergonomically designed for easy one-hand operation.
- Advanced anti-static composite and stainless steel construction; cannot rust or corrode.
- Impact resistant with non-scratch surface.
- Conforms to ISO 4414 standard, and these specifications: 7.2/7.4 European full flow profile.



Coupler Body Size	Part Number	Thread Size NPT	Air Flow Range SCFM (LPM)
1/4"	97566	1/4" Female	Up to 55 (1,558)
	97567	1/4" Male	

Coupler/Plug Assemblies

- Assemblies include one coupler and one plug.
- Maximum working pressure: 150 PSIG (10 Bar).
- Temperature Range: -4°F to 212°F (-20°C to 100°C).



Plugs with Steel and Brass Couplers

Coupler Body Size	Part Number	Coupler Thread Size (NPT)	Plug Body Size	Plug Thread Size (NPT)	Air Flow Range SCFM (LPM)
1/4"	95676	1/4" Female	1/4"	1/4" Male	Up to 74 (2,095)
	95850	1/4" Female	1/4"	1/4" Female	
	95685	1/4" Male	1/4"	1/4" Male	
	95851	1/4" Male	1/4"	1/4" Female	
3/8"	98265	3/8" Female	3/8"	3/8" Male	Up to 138 (3,900)
	98266	3/8" Female	3/8"	3/8" Female	
	98267	3/8" Male	3/8"	3/8" Male	
	98268	3/8" Male	3/8"	3/8" Female	
1/2"	98273	1/2" Female	1/2"	1/2" Male	Up to 138 (3,900)
	98274	1/2" Female	1/2"	1/2" Female	
	98275	1/2" Male	1/2"	1/2" Male	
	98276	1/2" Male	1/2"	1/2" Female	

Plugs with Black Composite-Style Couplers

Coupler Body Size	Part Number	Coupler Thread Size (NPT)	Plug Body Size	Plug Thread Size (NPT)	Air Flow Range SCFM (LPM)
1/4"	94990	1/4" Female	1/4"	1/4" Male	Up to 54 (1,529)
	94991	1/4" Female	1/4"	1/4" Female	
	94992	1/4" Male	1/4"	1/4" Male	
	94993	1/4" Male	1/4"	1/4" Female	

Plugs with Safety Couplers

Coupler Body Size	Part Number	Coupler Thread Size (NPT)	Plug Body Size	Plug Thread Size (NPT)	Air Flow Range SCFM (LPM)
1/4"	97572	1/4" Female	1/4"	1/4" Male	Up to 55 (1,558)
	97573	1/4" Female	1/4"	1/4" Female	
	97574	1/4" Male	1/4"	1/4" Male	
	97575	1/4" Male	1/4"	1/4" Female	

Narrow Abrasive Belts

DynaCut Zirconia Alumina (Z/A) Coated Abrasive Belts:

Versatile, high-performance mineral that is sharp, hard and tough. For metalworking finishing on stainless steel, nickel alloy, forged steel and aluminum.

DynaCut Aluminum Oxide (A/O) Coated Abrasive Belts:

The most common mineral for general purpose applications, primarily on softer metals. For light and heavier grinding, plus blending on aluminum, carbon steel, brass and bronze.

DynaCut Premium Ceramic (PCER) Coated Abrasive Belts:

Self-sharpening design lasts 50% to 200% longer than other belts. For light/heavier grinding, coatings removal on stainless steel, carbon steel, titanium, nickel alloy, chrome and inconel.

DynaBrite® & DynaBrite® Premium Surface Conditioning (NWN) Belts:

Tough reinforced non-woven nylon impregnated with abrasive grain and resin. Ideal for surface conditioning, decorative finishing, light/heavy cleaning, blending and polishing.



W x L (Inches)	Belt Type	Belt Brand	COATED ABRASIVES								SURFACE CONDITIONING (NWN)			Package Quantity
			36 Grit	40 Grit	60 Grit	80 Grit	120 Grit	180 Grit	220 Grit	320 Grit	Coarse	Medium	Very Fine	
1/8 x 12	Z/A	DynaCut	•	•	•	79004	79005	•	•	•	n/a	n/a	n/a	50
1/8 x 12	A/O	DynaCut	•	•	•	92206	92207	92208	92209	92210	n/a	n/a	n/a	50
1/8 x 12	PCER	DynaCut Premium	•	•	•	79103	79183	•	•	•	n/a	n/a	n/a	50
1/8 x 18	Z/A	DynaCut	•	•	•	79024	79025	•	•	•	n/a	n/a	n/a	50
1/8 x 18	A/O	DynaCut	•	•	90211	92228	92229	92232	92233	92234	n/a	n/a	n/a	50
1/8 x 18	PCER	DynaCut Premium	•	•	•	79118	79186	•	•	•	n/a	n/a	n/a	50
1/8 x 24	Z/A	DynaCut	•	•	79049	79054	79055	•	•	•	n/a	n/a	n/a	50
1/8 x 24	A/O	DynaCut	•	•	90405	90407	90409	90410	90411	90412	n/a	n/a	n/a	50
1/8 x 24	PCER	DynaCut Premium	•	•	79139	79143	79191	•	•	•	n/a	n/a	n/a	50
1/4 x 12	Z/A	DynaCut	•	79006	79007	79008	79009	•	•	•	n/a	n/a	n/a	50
1/4 x 12	A/O	DynaCut	•	•	91425	91426	91427	92118	92119	92120	n/a	n/a	n/a	50
1/4 x 12	PCER	DynaCut Premium	•	79104	79105	79106	79184	•	•	•	n/a	n/a	n/a	50
1/4 x 18	Z/A	DynaCut	79070	79026	79027	79028	79029	•	•	•	n/a	n/a	n/a	50
1/4 x 18	A/O	DynaCut	•	91142	91114	91115	91116	90224	90225	90226	n/a	n/a	n/a	50
1/4 x 18	PCER	DynaCut Premium	•	79119	79120	79121	79187	•	•	•	n/a	n/a	n/a	50
1/4 x 18	NWN	DynaBrite®	→								78015	78016	78017	10
1/4 x 18	NWN	DynaBrite® Premium	→								79504	79505	79506	10
1/4 x 24	Z/A	DynaCut	79046	79056	79057	79058	79059	•	•	•	n/a	n/a	n/a	50
1/4 x 24	A/O	DynaCut	•	91151	91434	91435	91436	90423	90424	90425	n/a	n/a	n/a	50
1/4 x 24	PCER	DynaCut Premium	•	79144	79145	79146	79192	•	•	•	n/a	n/a	n/a	50
1/4 x 24	NWN	DynaBrite®	→								78045	78046	78047	10
1/4 x 24	NWN	DynaBrite® Premium	→								79508	79509	79510	10
1/4 x 30	Z/A	DynaCut	•	92175	92176	92177	92178	•	•	•	n/a	n/a	n/a	50
1/4 x 30	A/O	DynaCut	•	•	•	•	•	90471	90472	90473	n/a	n/a	n/a	50
1/4 x 30	PCER	DynaCut Premium	•	•	•	•	•	•	•	•	n/a	n/a	n/a	50
1/4 x 34	A/O	DynaCut	•	•	90475	90477	90479	•	•	•	n/a	n/a	n/a	50
1/4 x 72	Z/A	DynaCut	•	94807	94771	94777	94789	•	•	•	n/a	n/a	n/a	50
1/4 x 72	A/O	DynaCut	•	•	•	•	•	94795	94801	•	n/a	n/a	n/a	50
1/4 x 72	NWN	DynaBrite®	→								•	•	78084	10
1/4 x 72	NWN	DynaBrite® Premium	→								79558	79562	79566	10

• Call for availability and pricing. n/a = Not Available. Ask about Super Fine Belts, also available!

Call Toll-Free: 1-800-828-7333



Dynafile®

Dynafile® II

Mini-Dynafile® II

Dynafile® III

Dynabelter®

Narrow Abrasive Belts (Cont'd.)

Z/A = DynaCut Zirconia Alumina

A/O = DynaCut Aluminum Oxide

PCER = DynaCut Premium Ceramic

NWN = DynaBrite® & DynaBrite®
Premium Surface Conditioning



W x L (Inches)	Belt Type	Belt Brand	COATED ABRASIVES								SURFACE CONDITIONING (NWN)			Package Quantity
			36 Grit	40 Grit	60 Grit	80 Grit	120 Grit	180 Grit	220 Grit	320 Grit	Coarse	Medium	Very Fine	
3/8 x 13	A/O	DynaCut	•	•	91162	91163	91164	•	•	•	n/a	n/a	n/a	50
3/8 x 13	Z/A	DynaCut	•	•	79074	79075	79076	•	•	•	n/a	n/a	n/a	50
1/2 x 12	Z/A	DynaCut	•	79010	79011	79012	79013	•	•	•	n/a	n/a	n/a	50
1/2 x 12	A/O	DynaCut	•	•	91428	91429	91430	92114	92115	92116	n/a	n/a	n/a	50
1/2 x 12	PCER	DynaCut Premium	•	79107	79108	79109	79185	•	•	•	n/a	n/a	n/a	50
1/2 x 12	NWN	DynaBrite®									78006	78007	78008	10
1/2 x 12	NWN	DynaBrite® Premium									79512	79513	79514	10
1/2 x 13	A/O	DynaCut	•	•	91165	91166	91167	•	•	•	n/a	n/a	n/a	50
1/2 x 13	Z/A	DynaCut	•	•	79077	79078	79079	•	•	•	n/a	n/a	n/a	50
1/2 x 18	Z/A	DynaCut	79015	79030	79031	79032	79033	•	•	•	n/a	n/a	n/a	50
1/2 x 18	A/O	DynaCut	•	91143	91117	91118	91119	90244	90245	90246	n/a	n/a	n/a	50
1/2 x 18	PCER	DynaCut Premium	•	79122	79123	79124	79188	•	•	•	n/a	n/a	n/a	50
1/2 x 18	NWN	DynaBrite®									78019	78020	78021	10
1/2 x 18	NWN	DynaBrite® Premium									79516	79517	79518	10
1/2 x 24	Z/A	DynaCut	79047	79060	79061	79062	79063	•	•	•	n/a	n/a	n/a	50
1/2 x 24	A/O	DynaCut	91149	91152	91437	91438	91439	90449	90451	90453	n/a	n/a	n/a	50
1/2 x 24	PCER	DynaCut Premium	•	79147	79148	79149	79193	•	•	•	n/a	n/a	n/a	50
1/2 x 24	NWN	DynaBrite®									78049	78050	78051	10
1/2 x 24	NWN	DynaBrite® Premium									79520	79521	79522	10
1/2 x 30	Z/A	DynaCut	•	92180	92181	92182	92183	•	•	•	n/a	n/a	n/a	50
1/2 x 30	A/O	DynaCut	•	•	90671	90672	90673	90493	90494	90496	n/a	n/a	n/a	50
1/2 x 30	PCER	DynaCut Premium	•	79166	79167	79168	•	•	•	•	n/a	n/a	n/a	50
1/2 x 30	NWN	DynaBrite®									78063	78064	78065	10
1/2 x 30	NWN	DynaBrite® Premium									79524	79525	79526	10
1/2 x 34	A/O	DynaCut	•	•	90495	90497	90499	•	•	•	n/a	n/a	n/a	50
1/2 x 44	A/O	DynaCut	•	•	90545	90547	90549	•	•	•	n/a	n/a	n/a	50
1/2 x 72	Z/A	DynaCut	•	94808	94772	94778	94790	•	•	•	n/a	n/a	n/a	50
1/2 x 72	A/O	DynaCut	•	•	•	•	•	94796	94802	•	n/a	n/a	n/a	50
1/2 x 72	NWN	DynaBrite®									78086	78087	78088	10
3/4 x 18	Z/A	DynaCut	79017	79034	79035	79036	79037	•	•	•	n/a	n/a	n/a	50
3/4 x 18	A/O	DynaCut	•	91144	91123	91124	91125	90254	90255	90256	n/a	n/a	n/a	50
3/4 x 18	PCER	DynaCut Premium	•	79125	79126	79127	79189	•	•	•	n/a	n/a	n/a	50
3/4 x 18	NWN	DynaBrite®									78024	78025	78026	10
3/4 x 18	NWN	DynaBrite® Premium									79528	79529	79530	10
3/4 x 20-1/2	Z/A	DynaCut	•	90640	90641	90642	90643	•	•	•	n/a	n/a	n/a	50
3/4 x 20-1/2	A/O	DynaCut	•	•	•	•	•	90334	90335	90336	n/a	n/a	n/a	50
3/4 x 20-1/2	PCER	DynaCut Premium	•	79133	79134	79135	•	•	•	•	n/a	n/a	n/a	50
3/4 x 20-1/2	NWN	DynaBrite®									78124	78119	78118	50
3/4 x 34	A/O	DynaCut	•	•	90367	90368	90370	•	•	•	n/a	n/a	n/a	50
3/4 x 34	NWN	DynaBrite®									78117	78116	78115	50

• Call for availability and pricing. n/a = Not Available. Ask about Super Fine Belts, also available!

Call Toll-Free: 1-800-828-7333

Narrow Abrasive Belts (Cont'd.)

Z/A = DynaCut Zirconia Alumina

A/O = DynaCut Aluminum Oxide

PCER = DynaCut Premium Ceramic

NWN = DynaBrite® & DynaBrite®
Premium Surface Conditioning



W x L (Inches)	Belt Type	Belt Brand	COATED ABRASIVES								SURFACE CONDITIONING (NWN)			Package Quantity	
			36 Grit	40 Grit	60 Grit	80 Grit	120 Grit	180 Grit	220 Grit	320 Grit	Coarse	Medium	Very Fine		
1 x 11	NWN	DynaBrite®										79554	79547	79543	10
1 x 15-1/2	Z/A	DynaCut	•	90194	90195	90196	90197	•	•	•	n/a	n/a	n/a	50	
1 x 15-1/2	NWN	DynaBrite®										78078	78079	78094	10
1 x 18	Z/A	DynaCut	79019	79038	79039	79040	79041	•	•	•	n/a	n/a	n/a	50	
1 x 18	A/O	DynaCut	•	91150	91126	91127	91128	90288	90289	90290	n/a	n/a	n/a	50	
1 x 18	PCER	DynaCut Premium	•	79128	79129	79175	79190	•	•	•	n/a	n/a	n/a	50	
1 x 18	NWN	DynaBrite®										78029	78030	78031	10
1 x 18	NWN	DynaBrite® Premium										79532	79533	79534	10
1 x 24	Z/A	DynaCut	•	79064	79065	79066	79067	•	•	•	n/a	n/a	n/a	50	
1 x 24	A/O	DynaCut	•	91153	•	•	•	90486	90487	90488	n/a	n/a	n/a	50	
1 x 24	PCER	DynaCut Premium	•	79150	79151	79152	79194	•	•	•	n/a	n/a	n/a	50	
1 x 24	NWN	DynaBrite®										78054	78055	78056	10
1 x 24	NWN	DynaBrite® Premium										79536	79537	79538	10
1 x 30	Z/A	DynaCut	•	92185	92186	92187	92188	•	•	•	n/a	n/a	n/a	50	
1 x 30	A/O	DynaCut	•	•	90674	90675	90676	90512	90513	90514	n/a	n/a	n/a	50	
1 x 30	PCER	DynaCut Premium	•	79169	79170	79171	•	•	•	•	n/a	n/a	n/a	50	
1 x 30	NWN	DynaBrite®										78066	78067	78068	10
1 x 30	NWN	DynaBrite® Premium										79540	79541	79542	10
1 x 72	Z/A	DynaCut	•	94809	94773	94779	94791	•	•	•	n/a	n/a	n/a	10	
1 x 72	A/O	DynaCut	•	•	•	•	•	94797	94803	•	n/a	n/a	n/a	10	
1 x 72	NWN	DynaBrite®										78090	78091	78092	1
1-1/2 x 15-1/2	Z/A	DynaCut	•	90190	90191	90192	90193	•	•	•	n/a	n/a	n/a	50	
1-1/2 x 15-1/2	NWN	DynaBrite®										78095	78096	78097	10
1-1/2 x 24	A/O	DynaCut	•	•	91632	91633	91634	91635	91628	91629	n/a	n/a	n/a	10	
2 x 15-1/2	Z/A	DynaCut	•	90198	90199	90200	90201	•	•	•	n/a	n/a	n/a	50	
2 x 15-1/2	NWN	DynaBrite®										79322	79323	79324	10
2 x 30	Z/A	DynaCut	•	92190	92191	92192	92193	•	•	•	n/a	n/a	n/a	10	
2 x 30	A/O	DynaCut	•	•	90677	90678	90679	90390	90391	90392	n/a	n/a	n/a	10	
2 x 30	PCER	DynaCut Premium	•	79172	79173	79174	•	•	•	•	n/a	n/a	n/a	10	
2 x 30	NWN	DynaBrite®										78069	78070	78071	1
2 x 30	NWN	DynaBrite® Premium										79544	79545	79546	1
2 x 34	Z/A	DynaCut	90360	90362	90363	90364	90372	•	•	•	n/a	n/a	n/a	10	
2 x 34	A/O	DynaCut	•	90376	90377	90378	90380	90381	90375	90388	n/a	n/a	n/a	10	
2 x 34	NWN	DynaBrite®										78075	78076	78077	1
2 x 36	A/O	DynaCut	•	•	91637	91638	91639	91640	91641	91642	n/a	n/a	n/a	10	
2 x 42	A/O	DynaCut	•	81002	81004	81005	81007	81009	81010	81012	n/a	n/a	n/a	10	
2 x 45	A/O	DynaCut	•	90348	90349	90350	90352	•	•	•	n/a	n/a	n/a	10	
2 x 48	A/O	DynaCut	•	•	91643	91644	91645	91646	91647	91648	n/a	n/a	n/a	10	
2 x 48	Z/A	DynaCut	•	•	91652	91655	91656	•	•	•	n/a	n/a	n/a	10	
2 x 48	NWN	DynaBrite®										81237	81238	81239	1
2 x 60	A/O	DynaCut	•	81030	81032	81033	81035	81037	81038	81040	n/a	n/a	n/a	10	

• Call for availability and pricing. n/a = Not Available. Ask about Super Fine Belts, also available!

Call Toll-Free: 1-800-828-7333

Narrow Abrasive Belts (Cont'd.)

Z/A = DynaCut Zirconia Alumina

A/O = DynaCut Aluminum Oxide

PCER = DynaCut Premium Ceramic

NWN = DynaBrite® & DynaBrite®
Premium Surface Conditioning



W x L (Inches)	Belt Type	Belt Brand	COATED ABRASIVES								SURFACE CONDITIONING (NWN)			Package Quantity
			36 Grit	40 Grit	60 Grit	80 Grit	120 Grit	180 Grit	220 Grit	320 Grit	Coarse	Medium	Very Fine	
2 x 72	Z/A	DynaCut	•	94811	94775	94781	94793	•	•	•	n/a	n/a	n/a	10
2 x 72	A/O	DynaCut	•	•	•	•	•	94799	94805	•	n/a	n/a	n/a	10
2 x 72	NWN	DynaBrite®	→								78080	78081	78082	1
2 x 132	A/O	DynaCut	•	81044	81046	81047	81049	81051	81052	81054	n/a	n/a	n/a	10
2-1/4 x 9-3/4	Z/A	DynaCut	•	92259	92260	92261	92262	•	•	•	n/a	n/a	n/a	10
2-1/4 x 9-3/4	NWN	DynaBrite®	→								•	90095	90094	1
2-3/4 x 15-1/2	Z/A	DynaCut	•	90009	90017	90018	90020	•	•	•	n/a	n/a	n/a	10
2-3/4 x 15-1/2	A/O	DynaCut	•	•	90076	90077	90078	90026	90011	90012	n/a	n/a	n/a	10
2-3/4 x 15-1/2	NWN	DynaBrite®	→								90023	90022	90021	1
2-3/4 x 15-1/2	NWN	DynaBrite® Premium	→								79548	79549	79550	1
3 x 7-3/8	Z/A	DynaCut	•	90630	90631	90632	90633	•	•	•	n/a	n/a	n/a	10
3 x 7-3/8	A/O	DynaCut	•	•	•	•	•	90634	90635	90636	n/a	n/a	n/a	10
3 x 7-3/8	NWN	DynaBrite®	→								•	90092	90091	1
3 x 10-11/16	Z/A	DynaCut	•	92100	92101	92102	92103	•	•	•	n/a	n/a	n/a	10
3 x 10-11/16	A/O	DynaCut	•	•	90613	90614	90615	90268	90269	90270	n/a	n/a	n/a	10
3 x 10-11/16	NWN	DynaBrite®	→								90239	90238	90237	1
3 x 10-11/16	NWN	DynaBrite® Premium	→								79567	79568	79569	1
3 x 21	A/O	DynaCut	•	91184	91185	91186	91187	•	•	•	n/a	n/a	n/a	10
3 x 24	Z/A	DynaCut	79043	79050	79051	79052	79053	•	•	•	n/a	n/a	n/a	10
3 x 24	NWN	DynaBrite®	→								78040	78041	78042	1
3 x 24	NWN	DynaBrite® Premium	→								79559	79560	79561	1
3 x 132	A/O	DynaCut	•	81058	81060	81061	81063	81065	81066	81068	n/a	n/a	n/a	10
3-1/2 x 15-1/2	Z/A	DynaCut	90266	90267	90272	90273	90275	•	•	•	n/a	n/a	n/a	10
3-1/2 x 15-1/2	A/O	DynaCut	90346	90347	90353	90354	90355	90277	90338	90339	n/a	n/a	n/a	10
3-1/2 x 15-1/2	PCER	DynaCut Premium	79195	•	79196	79197	79199	•	•	•	n/a	n/a	n/a	10
3-1/2 x 15-1/2	NWN	DynaBrite®	→								90283	90282	90281	1
3-1/2 x 15-1/2	NWN	DynaBrite® Premium	→								79570	79571	79572	1
4 x 36	A/O	DynaCut	81071	81072	81074	81075	81077	81079	81080	81082	n/a	n/a	n/a	5
4 x 104	A/O	DynaCut	81085	81086	81088	81089	81091	81093	81094	81096	n/a	n/a	n/a	5
4 x 106	A/O	DynaCut	81099	81100	81102	81103	81105	81107	81108	81110	n/a	n/a	n/a	5
4 x 132	A/O	DynaCut	81113	81114	81116	81117	81119	81121	81122	81124	n/a	n/a	n/a	5
4 x 168	A/O	DynaCut	81127	81128	81130	81131	81133	81135	81136	81138	n/a	n/a	n/a	5
6 x 48	A/O	DynaCut	•	81142	81144	81145	81147	81149	81150	81152	n/a	n/a	n/a	5
7 x 10-11/16	A/O	DynaCut	•	•	•	•	90600	90601	•	90602	n/a	n/a	n/a	10
7 x 10-11/16	NWN	DynaBrite®	→								•	90098	90097	1
7 x 15-1/2	A/O	DynaCut	•	•	•	•	90603	90604	•	90605	n/a	n/a	n/a	10
9 x 26-5/16	A/O	DynaCut	•	•	•	•	90606	90607	•	90608	n/a	n/a	n/a	10

• Call for availability and pricing. n/a = Not Available. Ask about Super Fine Belts, also available!

Call Toll-Free: 1-800-828-7333

**For Tools, Accessories & Abrasives,
Visit www.Dynabrade.com!**

Discover The Dynabrade Difference!

Since 1969, Dynabrade has Achieved a Leadership Role in the Design and Manufacture of Unique Portable Abrasive Power Tools!

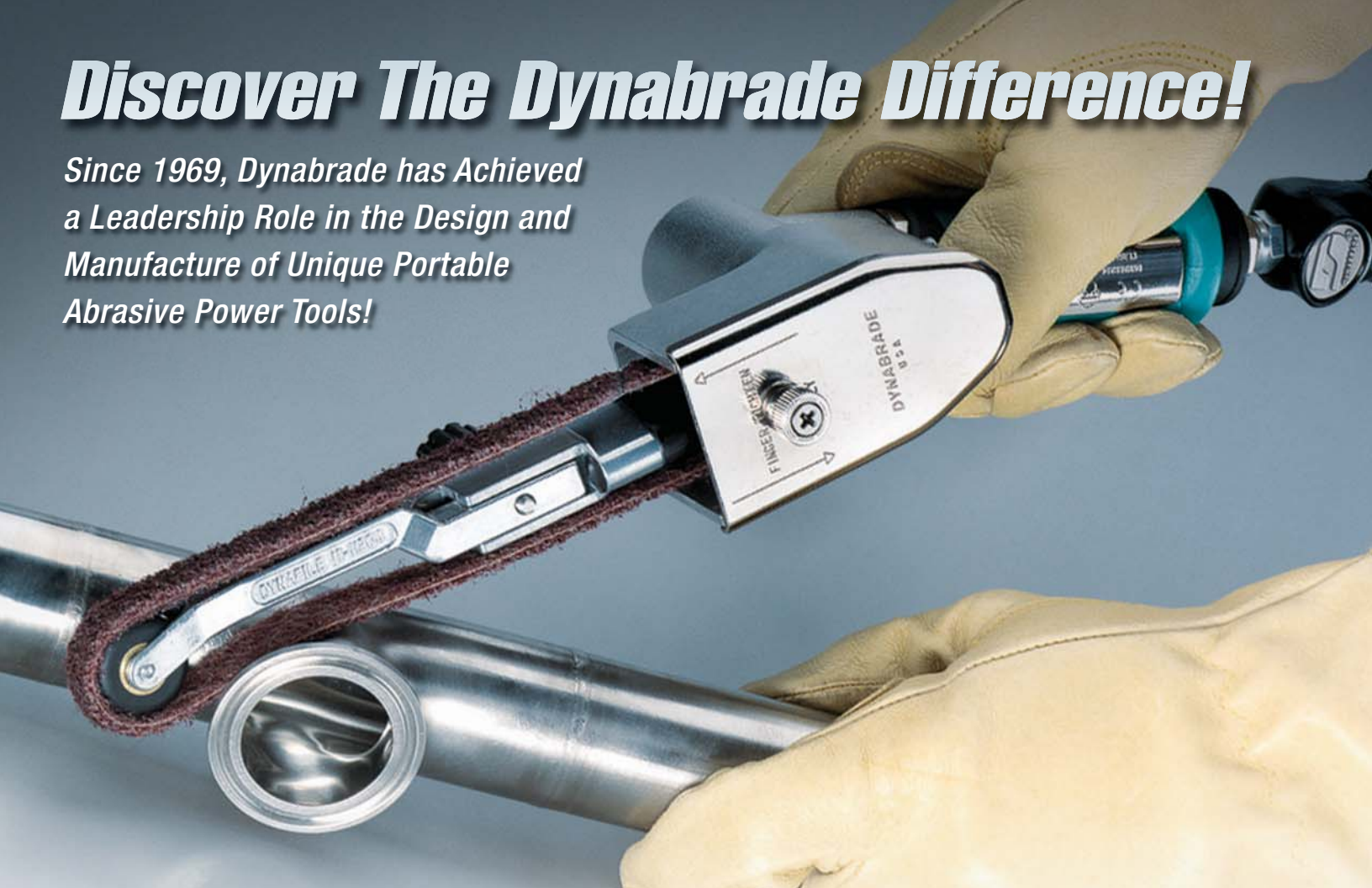

Visit our Website for more Tools and Related Accessories
www.dynabrade.com

DYNABRADE, INC. • DYNABRADE INTERNATIONAL
8989 Sheridan Drive • Clarence, New York 14031-1419
Phone: (716) 631-0100 • US Fax: 716-631-2073 • Int'l Fax: 716-631-2524
US Consumers Call Toll-Free: 1-800-828-7333
Canadian Consumers Call Toll-Free: 1-800-344-1488

DYNABRADE EUROPE S.à r.l.
Zone Artisanale Op Tomm 6 • L-5485 Wormeldange—Haut, Luxembourg
Telephone: +352 768 494 1 • Fax: +352 768 495

DYNABRADE DO BRASIL
Rua Oneda, 632 • Sao Bernardo do Campo • SP - CEP 09895-280
Telephone 55-11-4390-0133 • Fax 55-11-4399-1067

DYNABRADE INDIA ABRASIVE POWER TOOLS Pvt Ltd.
EL-54, TTC Industrial Area, M.I.D.C. Mahape, Electronic Zone, Navi Mumbai - 400705
Maharashtra, India • Telephone: +91 22 2763 2226 • Fax: +91 22 2763 2228

Try Our U.S. Consumer Toll-Free Number
1-888 DYNABRADE (or 1-800-828-7333)

DISTRIBUTED BY:

©DYNABRADE, INC., 2011

PRINTED IN USA

