

MODEL
DLB1200A/DLB1205A
1200lb/545kg CAPACITY
BRAKE WINCH

FRONT & SIDE VIEW

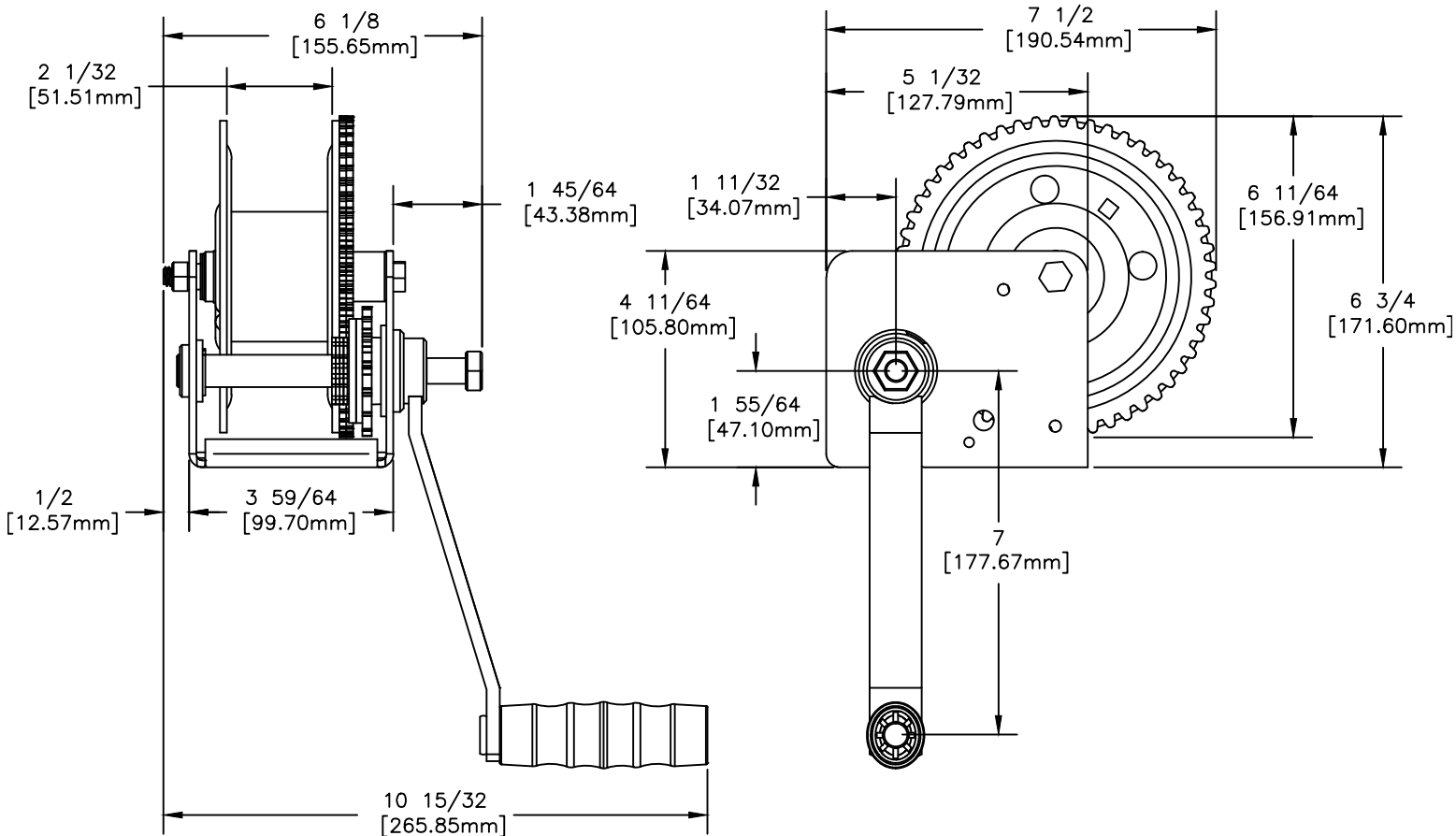

BASE HOLE PATTERN

