

S6624B and ST6624B

Available in Grid or Solid Top

COMPONENTS: 2-Shelf System

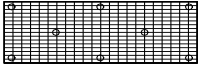

Panels: (2) 24"x66"
Legs: (6) 24"
Internal Stackers: (6)

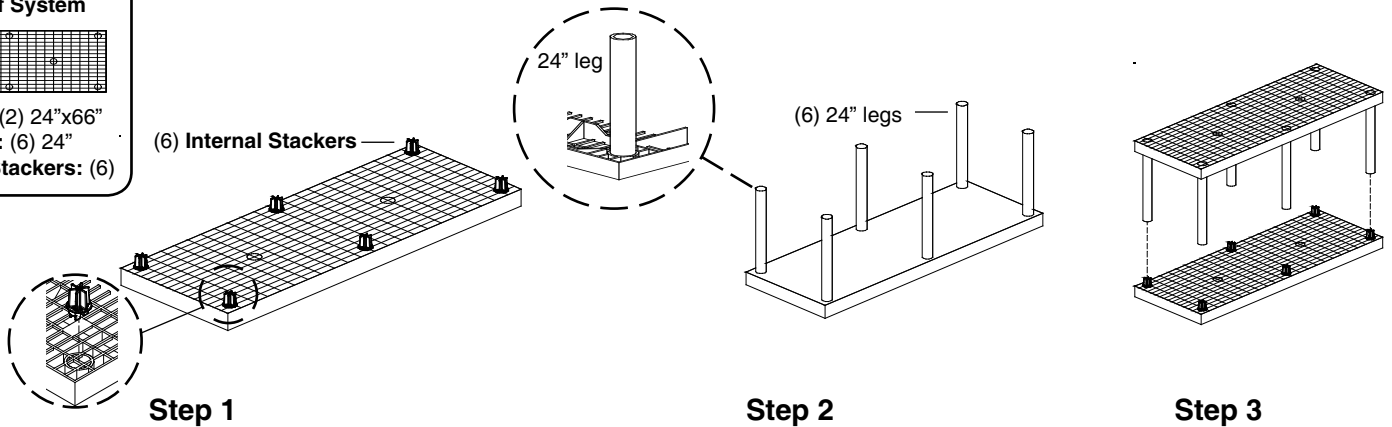

Step 1

Step 2

Step 3

COMPONENTS: 3-Shelf System

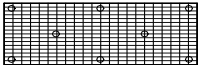

Panels: (3) 24"x66"
Legs: (12) 24"
Internal Stackers: (12)

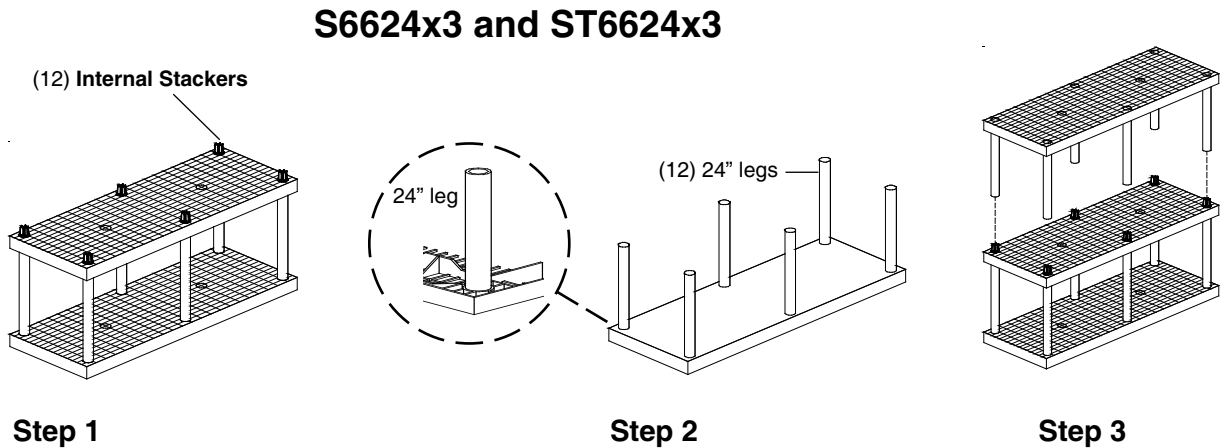

Step 1

Step 2

Step 3

COMPONENTS: 4-Shelf System

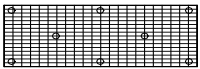

Panels: (4) 24"x66"
Legs: (18) 24"
Internal Stackers: (18)

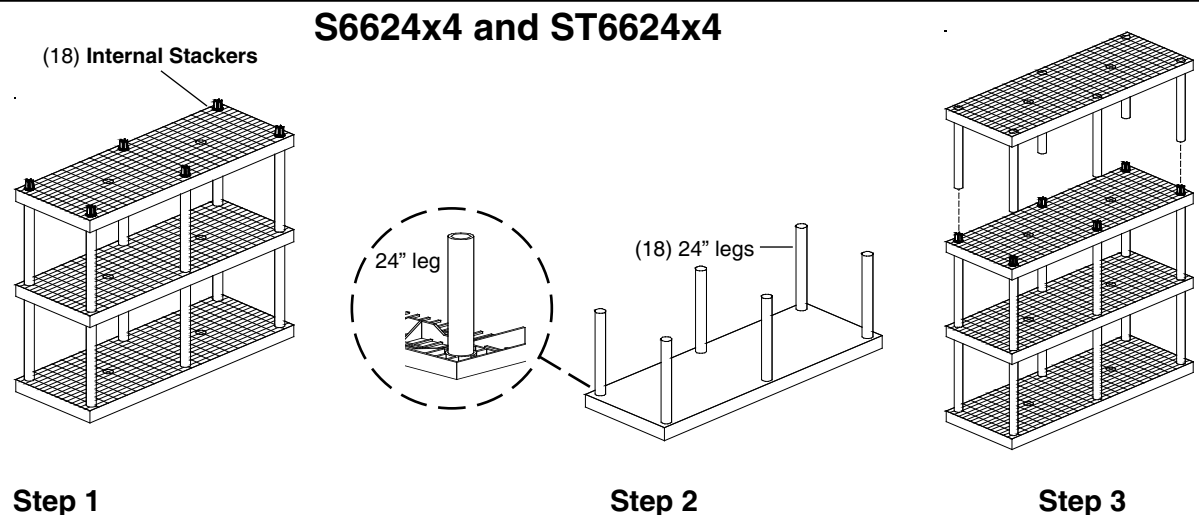

Step 1

Step 2

Step 3

Step 1

Lay one of the shelf panels on the floor and insert **Leg Stackers** over outside sockets as shown.

Step 2

Invert the next level panel and insert **24" posts** into the sockets as shown.

Step 3

Return panel with the **24" posts** to upright position. Align posts over **Leg Stackers** and push all the way down until leg stackers are inserted into posts. Repeat steps 1 through 3 for multi-shelf configurations.

S6636B and ST6636B

Available in Grid or Solid Top

COMPONENTS:

2-Shelf System

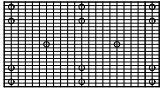

Panels: (2) 36"x66"

Legs: (12) 24"

Internal Stackers: (12)

(12) Internal Stackers

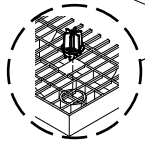

Step 1

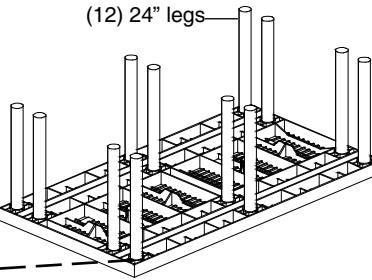
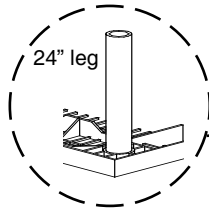

(12) 24" legs

Step 2

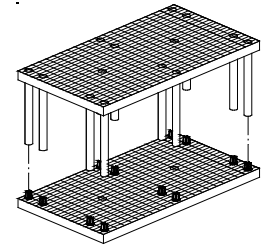

Step 3

S6636x3 and ST6636x3

COMPONENTS:

3-Shelf System

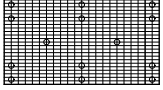

Panels: (3) 36"x66"

Legs: (24) 24"

Internal Stackers: (24)

(24) Internal Stackers

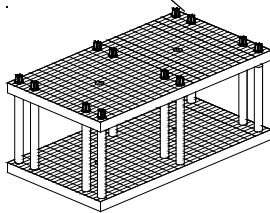

Step 1

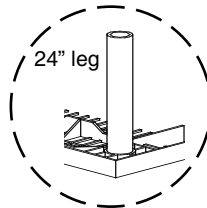

Step 2

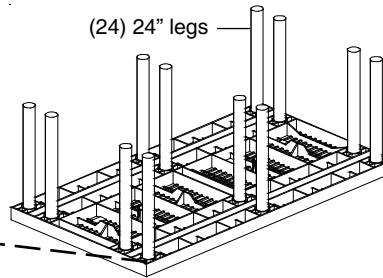

(24) 24" legs

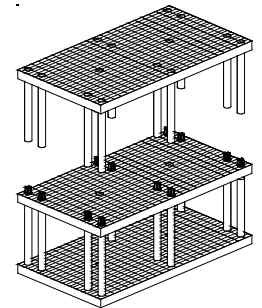

Step 3

S6636x4 and ST6636x4

COMPONENTS:

4-Shelf System

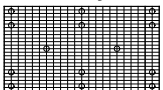

Panels: (4) 36"x66"

Legs: (36) 24"

Internal Stackers: (36)

(36) Internal Stackers

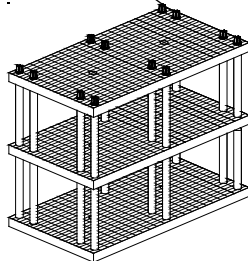

Step 1

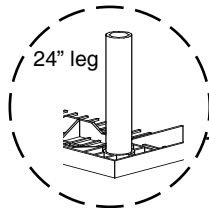

Step 2

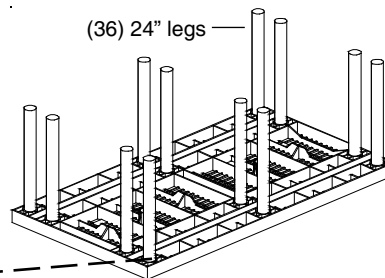

(36) 24" legs

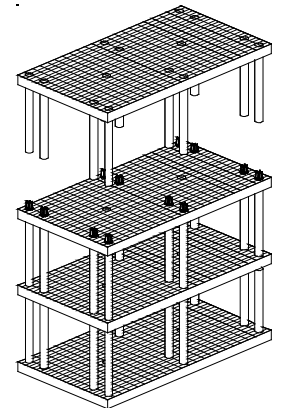

Step 3

Step 1

Lay one of the shelf panels on the floor and insert **Leg Stackers** over outside sockets as shown.

Step 2

Invert the next level panel and insert **24" posts** into the sockets as shown.

Step 3

Return panel with the **24" posts** to upright position. Align posts over **Leg Stackers** and push all the way down until leg stackers are inserted into posts. Repeat steps 1 through 3 for multi-shelf configurations.