

S3624B and ST3624B

Available in Grid or Solid Top

COMPONENTS:

2-Shelf System

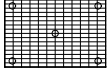

Panels: (2) 24"x36"

Legs: (4) 24"

Internal Stackers: (4)

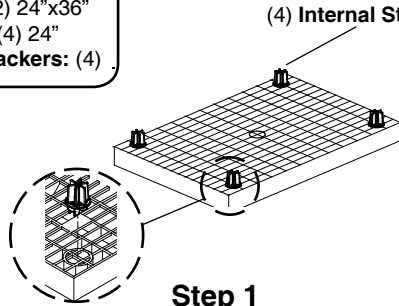

Step 1

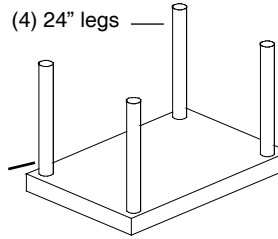
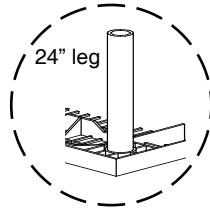

Step 2

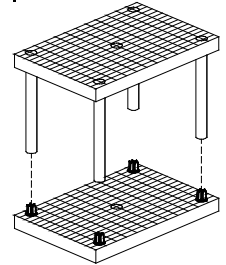

Step 3

S3624x3 and ST3624x3

COMPONENTS:

3-Shelf System

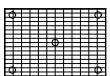

Panels: (3) 24"x36"

Legs: (8) 24"

Internal Stackers: (8)

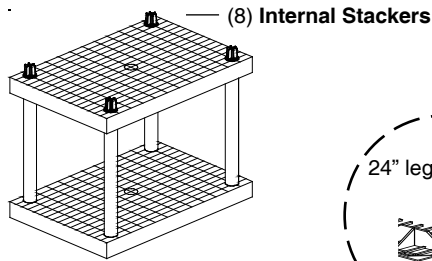

Step 1

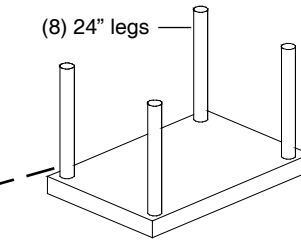
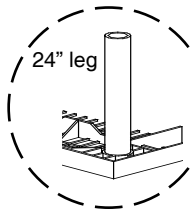

Step 2

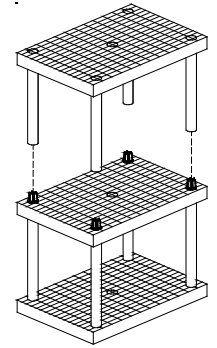

Step 3

S3624x4 and ST3624x4

COMPONENTS:

4-Shelf System

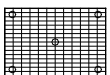

Panels: (4) 24"x36"

Legs: (12) 24"

Internal Stackers: (12)

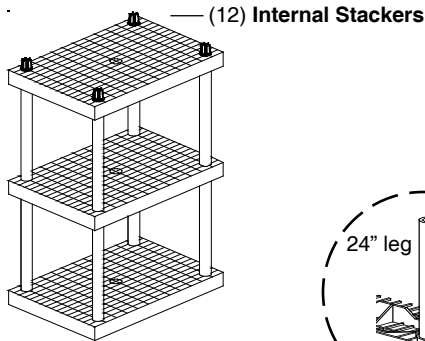

Step 1

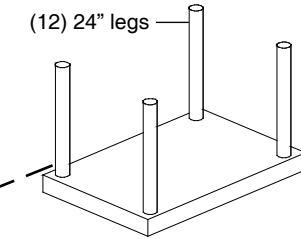
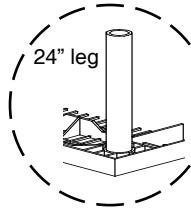

Step 2

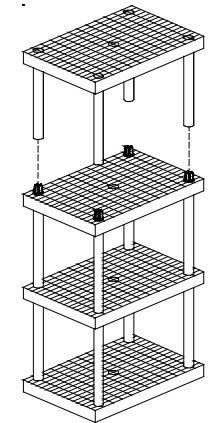

Step 3

Step 1

Lay one of the shelf panels on the floor and insert **Internal Stackers** over outside sockets as shown.

Step 2

Invert the next level panel and insert **24" posts** into the sockets as shown.

Step 3

Return panel with the **24" posts** to upright position. Align posts over **Leg Stackers** and push all the way down until **Internal Stackers** are inserted into posts. Repeat steps 1 through 3 for multi-shelf configurations.

COMPONENTS: 2-Shelf System

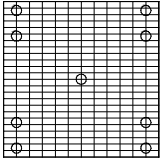

Panels: (2) 36"x36"
Legs: (8) 24"
Internal Stackers: (8)

S3636B and ST3636B

Available in Grid or Solid Top

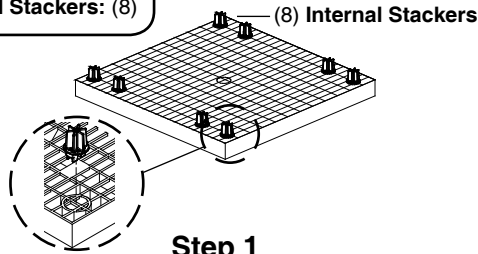

Step 1

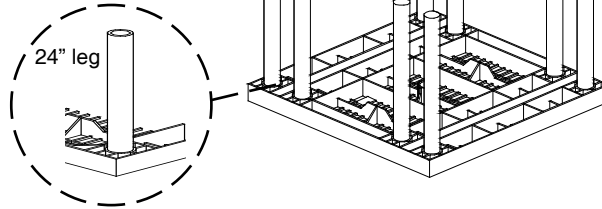

Step 2

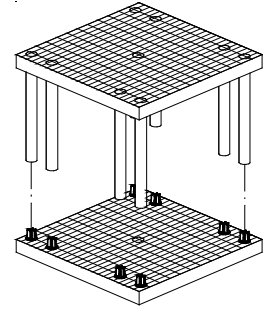

Step 3

COMPONENTS: 3-Shelf System

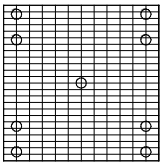

Panels: (3) 36"x36"
Legs: (16) 24"
Internal Stackers: (16)

S3636x3 and ST3636x3

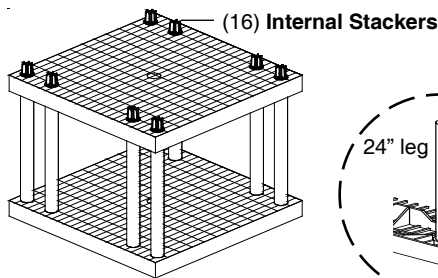

Step 1

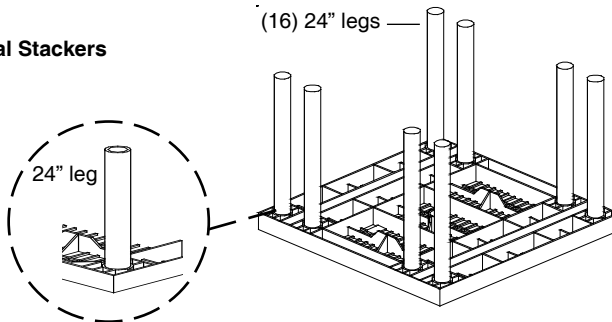

Step 2

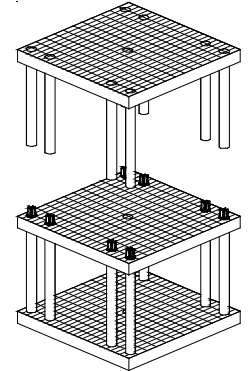

Step 3

COMPONENTS: 4-Shelf System

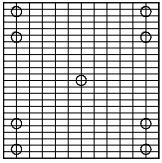

Panels: (4) 36"x36"
Legs: (24) 24"
Internal Stackers: (24)

S3636x4 and ST3636x4

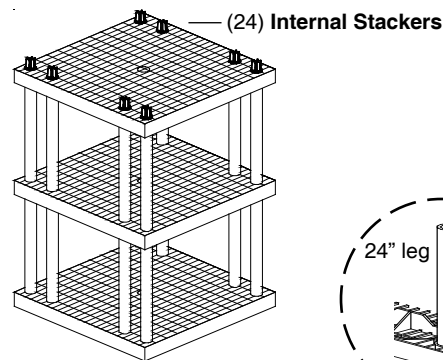

Step 1

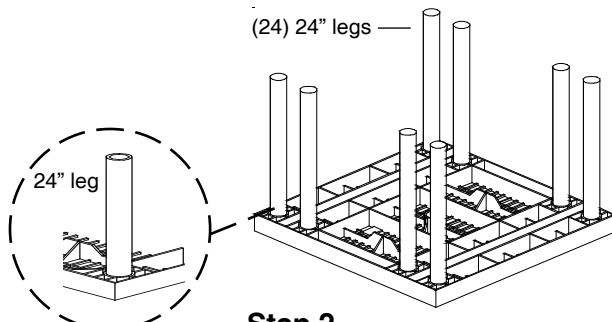

Step 2

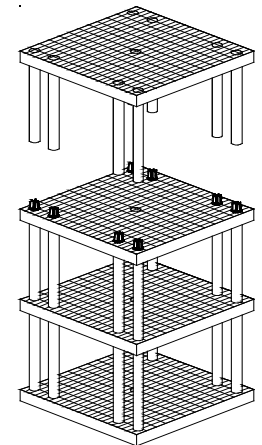

Step 3

Step 1

Lay one of the shelf panels on the floor and insert **Internal Stackers** over outside sockets as shown.

Step 2

Invert the next level panel and insert **24" posts** into the sockets as shown.

Step 3

Return panel with the **24" posts** to upright position. Align posts over **Leg Stackers** and push all the way down until **Internal Stackers** are inserted into posts. Repeat steps 1 through 3 for multi-shelf configurations.