

**PLEASE READ AND SAVE THESE INSTRUCTIONS.**

Read carefully before attempting to assemble, install, operate or maintain the product described. Protect yourself and others by observing all safety information. Failure to comply with instructions could result in personal injury and/or property damage! Retain instructions for future reference.

# Dayton® 18", 20", 24" & 30" Quiet Plus Pedestal & Wall Mount Fan

## Description

The 2WC and 4PR Series Quiet Plus Pedestal and Wall Mount Fan is designed for heavy duty and is energy efficient with the lowest watts per CFM. The ultra quiet die cast aluminum airfoil propeller is excellent for churches, schools, industrial and commercial applications. Features include: a 1/3 HP, 115V, 3 Speed, 1 Phase, Totally Enclosed Ball Bearing Motor; a patented Modular Motor End Dome for easy maintenance and a 15' Power Cord with Plug. The wall mountable fan can be installed by one person. Meets OSHA standards UL/ CUL listed.

## Unpacking

After unpacking unit, inspect carefully for any damage that may have occurred during transit. Check for loose, missing, or damaged parts. Shipping damage claim must be filed with carrier. Please make note of the model and serial numbers here for future reference.

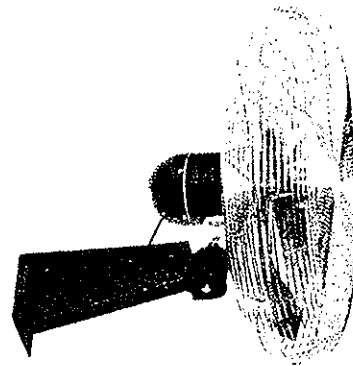

Figure 2

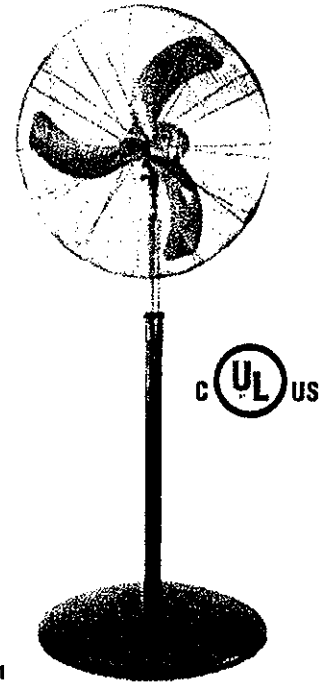

Figure 1

## Specifications

Model	CFM		HP	Propeller Dia. (in.)	Motor RPM		Volts	Amps
	Low/Med/High				Low/Med/High			
2WCF9*	4463/6259/8402		1/3	30	600/800/1098		115	2.60
2WCG1**	4463/6259/8402		1/3	30	600/800/1098		115	2.60
2WCG2*	4463/6259/8402		1/3	30	561/789/1045		115	2.80
2WCG3**	4463/6259/8402		1/3	30	561/789/1045		115	2.80
2WCG4*	3325/4556/5588		1/3	24	700/900/1110		115	2.50
2WCG5**	3325/4556/5588		1/3	24	700/900/1110		115	2.50
2WCG6*	3325/4556/5588		1/3	24	628/850/1070		115	2.50
2WCG7**	3325/4556/5588		1/3	24	628/850/1070		115	2.50
4PRV6*	1657/2060/3100		1/5	20	1120/745/600		115	1.65
4PRV7**	1657/2060/3100		1/5	20	1120/745/600		115	1.65
4PRV8*	1657/2060/3100		1/5	20	1120/745/600		115	1.65
4PRV9**	1657/2060/3100		1/5	20	1120/745/600		115	1.65
4PRW1*	1805/2113/2600		1/5	18	1125/915/780		115	1.41
4PRW2**	1805/2113/2600		1/5	18	1125/915/780		115	1.41
4PRW3*	1805/2113/2600		1/5	18	1125/915/780		115	1.41
4PRW4**	1805/2113/2600		1/5	18	1125/915/780		115	1.41

(\* Pedestal (\*\* Wall Mount Fan

ENGLISH

ESPAÑOL

FRANÇAIS

# Dayton® 18", 20", 24" & 30" Quiet Plus Pedestal & Wall Mount Fan

E  
N  
G  
L  
I  
S  
H

## Dimensions

Model	Dimensions (in.)				
	A	B	C	D	E
2WCF9*	5.25	33.39	8.0	2.5	2.50
2WCG1**	5.25	33.39	8.0	2.5	2.50
2WCG2*	5.25	33.39	10.5	2.5	5.25
2WCG3**	5.25	33.39	10.5	2.5	5.25
2WCG4*	6.25	26.90	8.0	2.5	2.50
2WCG5**	6.25	26.90	8.0	2.5	2.50
2WCG6*	6.25	26.90	10.5	2.5	5.25
2WCG7**	6.25	26.90	10.5	2.5	5.25
4PRV6*	6.25	23.39	8.0	2.5	2.50
4PRV7**	6.25	23.39	8.0	2.5	2.50
4PRV8*	6.25	23.39	10.5	2.5	5.25
4PRV9**	6.25	23.39	10.5	2.5	5.25
4PRW1*	6.25	23.39	8.0	2.5	2.50
4PRW2**	6.25	23.39	8.0	2.5	2.50
4PRW3*	6.25	23.39	10.5	2.5	5.25
4PRW4**	6.25	23.39	10.5	2.5	5.25

(\*) Pedestal (\*\*) Wall Mount Fan

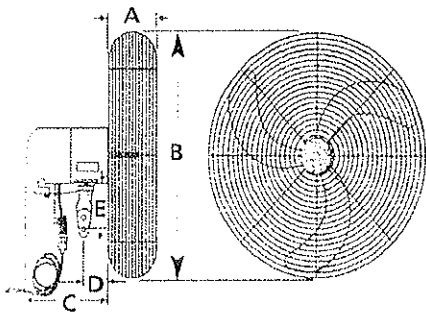

Figure 3 - Oscillating Motor

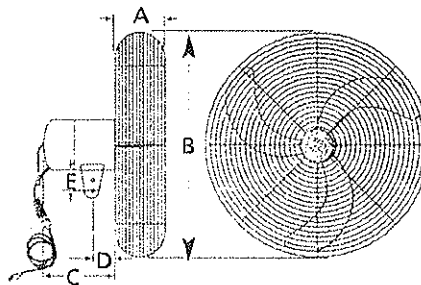

Figure 4 - Non-Oscillating Motor

## General Safety Information

**⚠ WARNING** To reduce the risk of fire or electric shock do not use any solid-state speed control device with this fan.

**⚠ CAUTION** Disconnect fan from power supply before servicing to reduce risk of fire or electric shock.

## Assembly

### PEDESTAL

Remove parts from bag [half strap (1), bolts (4), lock-washer (4)], position half strap "notched ends" toward base on underside. Then insert through bolts and attached lock-washer and nuts; do not tighten. Pedestal assembly should then be positioned into base. Secure from underside of base by tightening four bolts as illustrated.

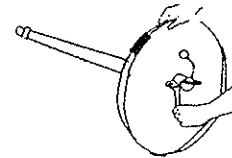

Figure 5

Attach motor to pedestal with 2 bolts provided.

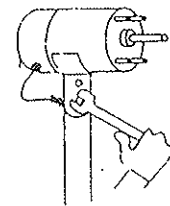

Figure 6

Attach rear half of guard to motor, using supplied washers and nuts.

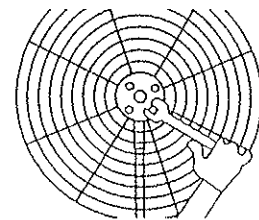

Figure 7

# Models 2WCF9, 2WCG1 thru 2WCG7, 4PRV6 thru 4PRV9 and 4PRW1 thru 4PRW4

## Assembly (Continued)

Attach propeller to motor. For steel propellers and aluminum props with 5/8" bore, align the two motor flats and tighten the two setscrews. Allow 3/4" clearance between propeller hub and motor so there is no rubbing while fan is operating.

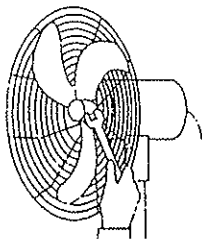

Figure 8

**CAUTION** Handle the propeller very carefully because it is perfectly balanced and aligned to insure smooth operation. Do not use a hammer to force the propeller onto the shaft. It should fit snugly but not so tightly that it will not slide on by the pressure of your hand.

Attach front half of guard. Spring wire tabs to hold in place using a screwdriver or other tool.

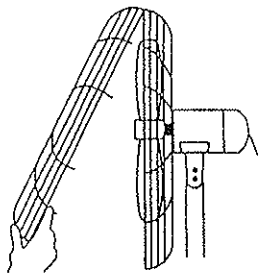

Figure 9

**NOTE:** For best fit, position the hooks on the front guard midway between the radial wires of the rear guard.

Raise pedestal to desired height and lock with setscrew using wrench.

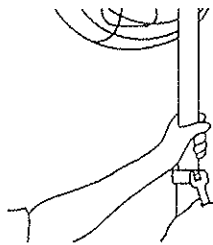

Figure 10

**WARNING** To reduce the risk of fire, electric shock and injury to persons, the fan must be installed with the blade, guard, wall bracket, pedestal and base marked on their cartons to indicate suitability with this model. Other blades, guards, wall brackets, pedestals and bases cannot be substituted.

### WALL MOUNT ASSEMBLY

In assembly, follow same instructions as Figures 7, 8 and 9 previously stated and illustrated.

### MOTOR ADJUSTMENTS

Motor is made with the highest quality materials and workmanship. With reasonable care, it will provide long and satisfactory service. Be sure the voltage and cycles shown on the motor nameplate correspond to the power supply.

**WARNING** To reduce the risk of fire or electric shock, observe the following: Before servicing or cleaning the unit, switch off the power at the service panel and lock service panel to prevent the power from being switched on accidentally.

### OSCILLATION ADJUSTMENT

The electric drive on oscillating motors has a 4-position detent, adjustable by turning the eccentric plate on the bottom. One position produces non-oscillation, another position produces a 45° oscillation arc, while the other two produce a 90° oscillation arc.

**CAUTION** Oscillating motor not to be used in upside down position.

Oscillating mechanism can be changed by grasping the eccentric plate and pulling down and twisting into another oscillation mode. The eccentric plate will snap in to one of the three oscillation patterns depending on where the eccentric plate is released from grasp. The connecting arm is not shown in this illustration and does not need to be removed to change oscillation. The mechanism is also a slip clutch. In the event that oscillation is impeded, the mechanism will release and move to a shorter pattern of oscillation. Neutral is the final slip mode if obstruction is still in interference with the oscillation pattern.

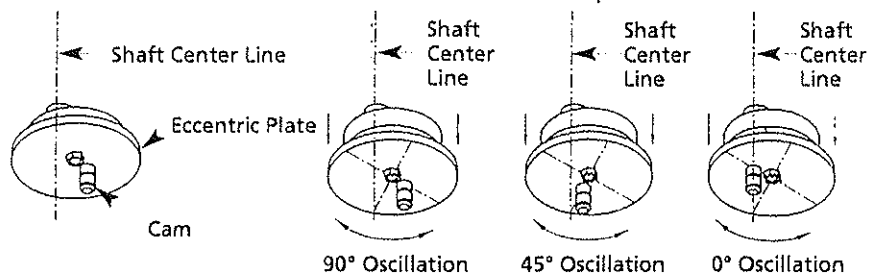

Figure 11 - Oscillation Adjustment

E  
N  
G  
L  
I  
S  
H



# Dayton® 18", 20", 24" & 30" Quiet Plus Pedestal & Wall Mount Fan

E  
N  
G  
L  
I  
S  
H

## Assembly (Continued)

### NON-OSCILLATING MOTORS

Motor bracket has two tilt adjustment holes to allow for maximum tilt. When using the outer hole to give maximum tilt, the two 1/8" thick washers (A) should be placed between the motor bracket and the mating bracket on the Pedestal or Wall Mount. This is necessary for proper clearance of the two mating parts.

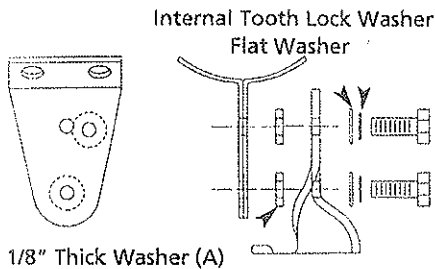

Figure 12 - Non-Oscillating Motors

### REAR GUARD ATTACHMENT

Place one fender washer on each through bolt. Place a shoulder nut on each through bolt and tighten 1½ turns. Place the guard on the motor, slipping the eyelets in the guard over the shoulder nuts. Rotate the guard away from eyelet until the radial wire supports rest against the through bolts. (Fender washer must be away from the eyelet.) Tighten shoulder nuts.

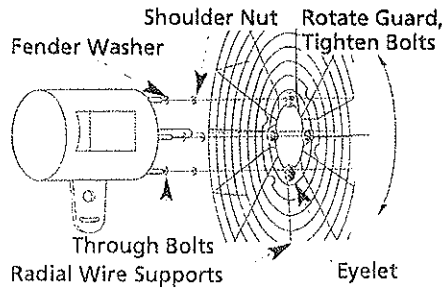

Figure 13 - Rear Guard Attachment

### INSTALLATION RECORD

Please complete for future use.

Model # \_\_\_\_\_

Serial # \_\_\_\_\_

Purchased from \_\_\_\_\_

Date Purchased \_\_\_\_\_

Date Installed \_\_\_\_\_

### SAFETY CABLE KIT

For a good safety practice, a safety cable kit is included and required for fans in an overhead mounting application. If material handling equipment strikes the fan or the mounting hardware fails the cable will prevent the fan from falling. The safety device consists of a 12" long, 1/16" diameter cable with a "U" clamp on one end and a "crimp" on the other end.

### Maintenance

**NOTES:** Keep blades clean. An accumulation of dirt may cause blade vibration and motor overload. Check tightness of blade screws occasionally.

Motor is equipped with pre-lubricated ball bearings. The original supply of lubricant is kept free of dirt, grit, or outside contamination by the bearing closures and does not require replenishment for the life of the bearing under normal operating conditions.

# For Repair Parts, call 1-800-323-0620

24 hours a day – 365 days a year

Please provide following information:

- Model number
- Serial number (if any)
- Part description and number as shown in parts list

E  
N  
G  
L  
I  
S  
H

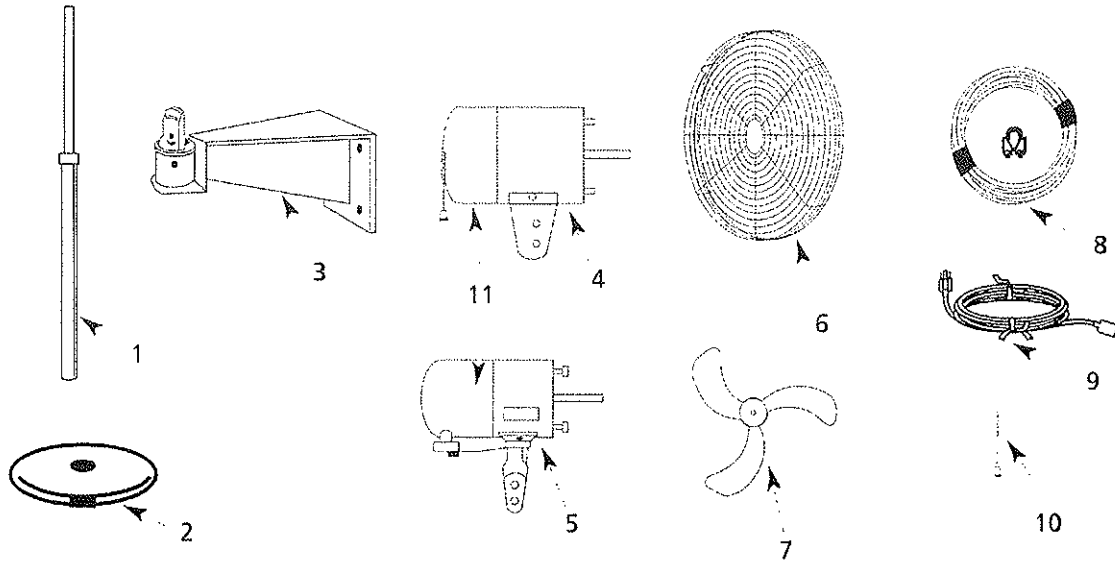

Figure 14a – Repair Parts Illustration for 18", 20", 24" & 30" Quiet Plus Pedestal & Wall Mount Fan

## Repair Parts List for 18", 20", 24" & 30" Quiet Plus Pedestal & Wall Mount Fan

Ref. No.	Description	Part Number for Models:								Qty
		2WCF9	2WCG1	2WCG2	2WCG3	2WCG4	2WCG5	2WCG6	2WCG7	
1	Pedestal	21152	N/A	21152	N/A	21152	N/A	21152	N/A	1
2	Base	21166	N/A	21166	N/A	21166	N/A	21166	N/A	1
3	Wall Bracket	N/A	21187	N/A	21187	N/A	21187	N/A	21187	1
4	Motor	21017	21017	N/A	N/A	21017	21017	N/A	N/A	1
5	Motor	N/A	N/A	21007	21007	N/A	N/A	21007	21007	1
6	Guard	21080	21080	21080	21080	21070	21070	21070	21070	1
7	Propeller	21105	21105	21105	21105	21095	21195	21195	21195	1
8	Safety Cable	21204	21204	21204	21204	21204	21204	21204	21204	1
9	Cord	01633	01633	01633	01633	01633	01633	01633	01633	1
10	Pull Chain Switch	01723	01723	01723	01723	01723	01723	01723	01723	1
11	End Dome Assembly	06004	06004	03915	03915	06004	06004	03915	03916	1
Δ	Gear Box Assembly	N/A	N/A	21777	21777	21777	N/A	21777	21777	1

(Δ) Not shown.

# For Repair Parts, call 1-800-323-0620

24 hours a day – 365 days a year

Please provide following information:

- Model number
- Serial number (if any)
- Part description and number as shown in parts list

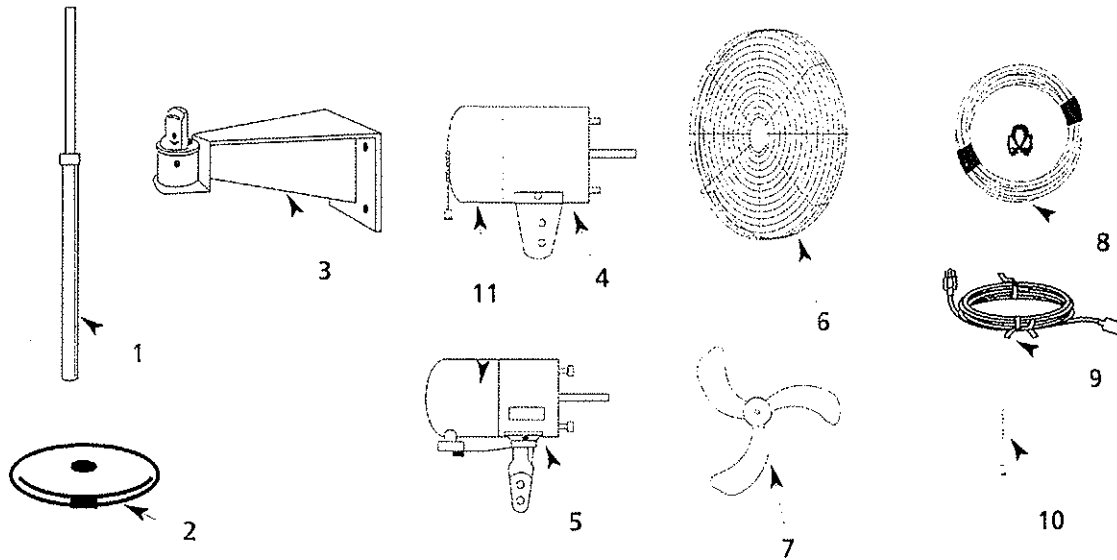

E  
N  
G  
L  
I  
S  
H

Figure 14b – Repair Parts Illustration for 18", 20", 24" & 30" Quiet Plus Pedestal & Wall Mount Fan (Continued)

## Repair Parts List for 18", 20", 24" & 30" Quiet Plus Pedestal & Wall Mount Fan (Continued)

Ref. No.	Description	Part Number for Models:								Qty
		4PRV6	4PRV7	4PRV8	4PRV9	4PRW1	4PRW2	4PRW3	4PRW4	
1	Pedestal	21152	N/A	21152	N/A	21152	N/A	21152	N/A	1
2	Base	21165	N/A	21165	N/A	21165	N/A	21165	N/A	1
3	Wall Bracket	N/A	21187	N/A	21187	N/A	21187	N/A	21187	1
4	Motor	N/A	N/A	78036	78036	N/A	N/A	78036	78036	1
5	Motor	78043	78043	N/A	N/A	78043	78043	N/A	N/A	1
6	Guard	71001	71001	71001	71001	71001	71001	71001	71001	1
7	Propeller	21102	21102	21102	21102	21101	21101	21101	21101	1
8	Safety Cable	N/A	21204	N/A	21204	N/A	21204	N/A	21204	1
9	Cord	01633	01633	01633	01633	01633	01633	01633	01633	1
10	Pull Chain Switch	01723	01723	01723	01723	01723	01723	01723	01723	1
11	End Dome Assembly	03915	03915	06004	06004	03915	03915	06004	06004	1
Δ	Gear Box Assembly	21177	21177	N/A	N/A	21177	21177	N/A	N/A	1

(Δ) Not shown.

# Dayton® 18", 20", 24" & 30" Quiet Plus Pedestal & Wall Mount Fan

E  
N  
G  
L  
I  
S  
H

## LIMITED WARRANTY

**DAYTON ONE-YEAR LIMITED WARRANTY.** DAYTON® 18", 20", 24" & 30" QUIET PLUS PEDESTAL & WALL MOUNT FAN, MODELS COVERED IN THIS MANUAL, ARE WARRANTED BY DAYTON ELECTRIC MFG. CO. (DAYTON) TO THE ORIGINAL USER AGAINST DEFECTS IN WORKMANSHIP OR MATERIALS UNDER NORMAL USE FOR ONE YEAR AFTER DATE OF PURCHASE. ANY PART WHICH IS DETERMINED TO BE DEFECTIVE IN MATERIAL OR WORKMANSHIP AND RETURNED TO AN AUTHORIZED SERVICE LOCATION, AS DAYTON DESIGNATES, SHIPPING COSTS PREPAID, WILL BE, AS THE EXCLUSIVE REMEDY, REPAIRED OR REPLACED AT DAYTON'S OPTION. FOR LIMITED WARRANTY CLAIM PROCEDURES, SEE "PROMPT DISPOSITION" BELOW. THIS LIMITED WARRANTY GIVES PURCHASERS SPECIFIC LEGAL RIGHTS WHICH VARY FROM JURISDICTION TO JURISDICTION.

**LIMITATION OF LIABILITY.** TO THE EXTENT ALLOWABLE UNDER APPLICABLE LAW, DAYTON'S LIABILITY FOR CONSEQUENTIAL AND INCIDENTAL DAMAGES IS EXPRESSLY DISCLAIMED. DAYTON'S LIABILITY IN ALL EVENTS IS LIMITED TO AND SHALL NOT EXCEED THE PURCHASE PRICE PAID.

**WARRANTY DISCLAIMER.** A DILIGENT EFFORT HAS BEEN MADE TO PROVIDE PRODUCT INFORMATION AND ILLUSTRATE THE PRODUCTS IN THIS LITERATURE ACCURATELY; HOWEVER, SUCH INFORMATION AND ILLUSTRATIONS ARE FOR THE SOLE PURPOSE OF IDENTIFICATION, AND DO NOT EXPRESS OR IMPLY A WARRANTY THAT THE PRODUCTS ARE MERCHANTABLE, OR FIT FOR A PARTICULAR PURPOSE, OR THAT THE PRODUCTS WILL NECESSARILY CONFORM TO THE ILLUSTRATIONS OR DESCRIPTIONS. EXCEPT AS PROVIDED BELOW, NO WARRANTY OR AFFIRMATION OF FACT, EXPRESSED OR IMPLIED, OTHER THAN AS STATED IN THE "LIMITED WARRANTY" ABOVE IS MADE OR AUTHORIZED BY DAYTON.

**Technical Advice and Recommendations, Disclaimer.** Notwithstanding any past practice or dealings or trade custom, sales shall not include the furnishing of technical advice or assistance or system design. Dayton assumes no obligations or liability on account of any unauthorized recommendations, opinions or advice as to the choice, installation or use of products.

**Product Suitability.** Many jurisdictions have codes and regulations governing sales, construction, installation, and/or use of products for certain purposes, which may vary from those in neighboring areas. While attempts are made to assure that Dayton products comply with such codes, Dayton cannot guarantee compliance, and cannot be responsible for how the product is installed or used. Before purchase and use of a product, review the product applications, and all applicable national and local codes and regulations, and be sure that the product, installation, and use will comply with them.

Certain aspects of disclaimers are not applicable to consumer products; e.g., (a) some jurisdictions do not allow the exclusion or limitation of incidental or consequential damages, so the above limitation or exclusion may not apply to you; (b) also, some jurisdictions do not allow a limitation on how long an implied warranty lasts, consequently the above limitation may not apply to you; and (c) by law, during the period of this Limited Warranty, any implied warranties of implied merchantability or fitness for a particular purpose applicable to consumer products purchased by consumers, may not be excluded or otherwise disclaimed.

**Prompt Disposition.** A good faith effort will be made for prompt correction or other adjustment with respect to any product which proves to be defective within limited warranty. For any product believed to be defective within limited warranty, first write or call dealer from whom the product was purchased. Dealer will give additional directions. If unable to resolve satisfactorily, write to Dayton at address below, giving dealer's name, address, date, and number of dealer's invoice, and describing the nature of the defect. Title and risk of loss pass to buyer on delivery to common carrier. If product was damaged in transit to you, file claim with carrier.

Manufactured for Dayton Electric Mfg. Co., 5959 W. Howard St., Niles, Illinois 60714-4014 U.S.A.

Manufactured for Dayton Electric Mfg. Co.  
Niles, Illinois 60714 U.S.A.

