

Control and Signaling Diameter 22mm **XB4 / ZB4**

Catalog
February
2004



Control and signalling units Ø 22

Harmony® style 4

Pushbuttons, switches and pilot lights with chromium plated metal bezel

Description

The Ø 22 range of metal control and signalling units comprises:

Complete units XB4 B



Pushbuttons and switches

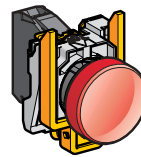

Pilot lights

Sub-assemblies ZB4 B

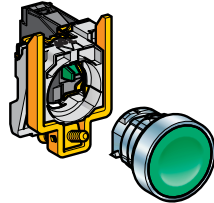

Pushbuttons and switches: body + head sub-assemblies

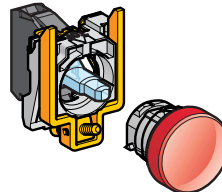





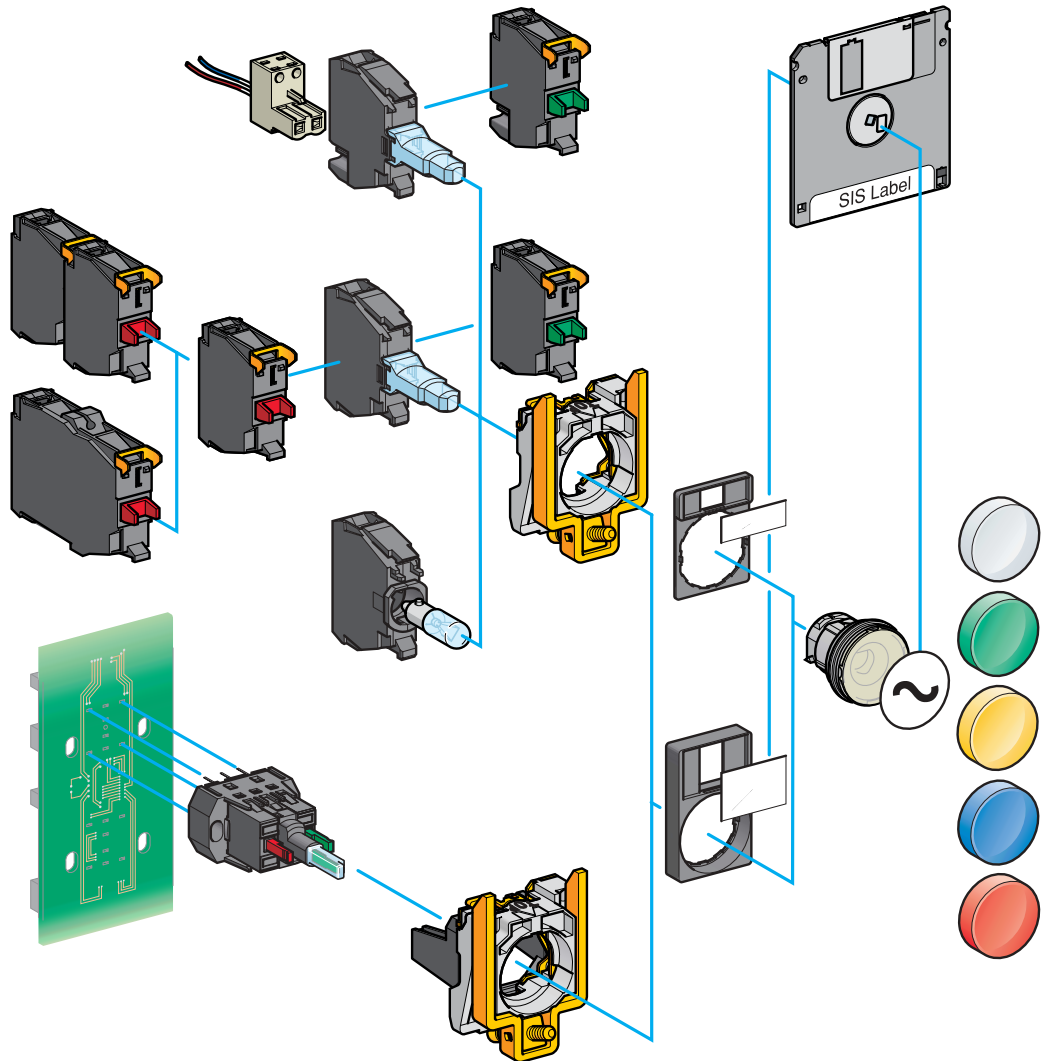





Pilot lights: body + head sub-assemblies

ZB component parts and accessories



Schematic library

Contact functions (pushbuttons and Emergency stop pushbuttons)

			
Pushbutton N/O contact	Pushbutton N/C contact	Mushroom head spring return N/O contact	Emergency stop mushroom head - Push-pull N/C contact
			
Emergency stop trigger action mushroom head Push-pull N/O + N/C contacts	Emergency stop mushroom head Turn to release N/C contact	Emergency stop mushroom head Turn to release, with key N/C contact	Emergency stop trigger action mushroom head Turn to release N/O + N/C contacts
			
Emergency stop mushroom head Trigger action Turn to release, with key N/O + N/C contacts	Double-headed pushbutton N/O + N/C contacts		

Contact functions (selector switches)

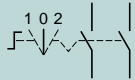
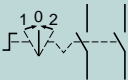
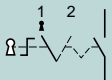
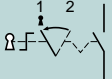
			
Selector switch 2-position stay put N/O contact	Selector switch 3-position stay put N/O + N/O contacts	Selector switch 3-position, 2 spring return to centre N/O + N/O contacts	Selector switch 2-position stay put, key withdrawal from LH position - N/O contact
			
Selector switch 2-position spring return from right to left, key withdrawal from LH position N/O contact			



Signalling functions

		
Pilot light with BA 9s incandescent bulb	LED pilot light	Pilot light with integral transformer ~ 230 V primary, 6 V secondary BA9s incandescent bulb or LED

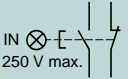
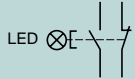
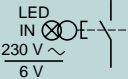
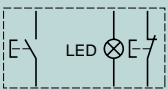
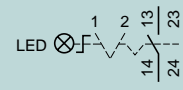
Combined functions, contact + signalling (pushbuttons and selector switches)

		
Illuminated pushbutton BA9s incandescent bulb N/O + N/C contacts	Illuminated pushbutton with LED N/O + N/C contacts	Illuminated pushbutton with integral transformer, ~ 230 V 50/60 Hz primary, 6 V secondary BA9s incandescent bulb or LED N/O + N/C contacts
		
Double-headed pushbutton with LED pilot light	Illuminated selector switch with LED - 2-position stay put N/O + N/C contacts	

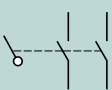
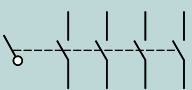
Joystick controller functions

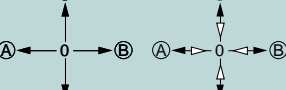
2 direction	4 direction
	
Without spring	Without spring
	
With spring	With spring

Control and signalling units Ø 22

Harmony® style 4

Pushbuttons, switches and pilot lights with chromium plated metal bezel

Complete units, XB4 B

Complete units

Contact functions

Pushbuttons, spring return

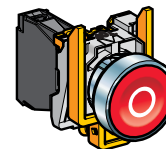
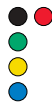

Flush push

XB4 BA01/BA42
see page 36002/2

XB4 BA3311
see page 36002/2

XB4 BA4322
see page 36002/2

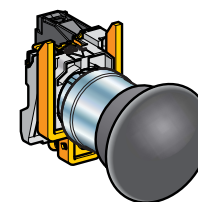
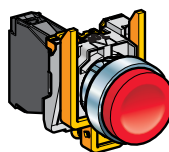

Booted flush push

XB4 BP01/BP42
see page 36002/2

Projecting push

XB4 BL42
see page 36002/2

Mushroom head

XB4 BC21
see page 36002/2

Double-headed pushbuttons, spring return

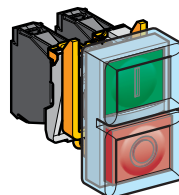
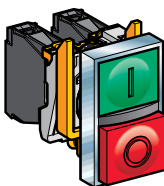

Flush push + projecting push

XB4 BL845
see page 36002/2

Booted flush push + projecting push

XB4 BL945
see page 36002/2

Ø 40 Emergency stop mushroom head pushbuttons with or without trigger action

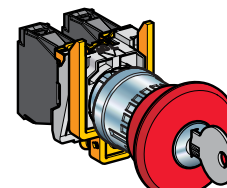
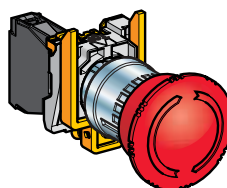
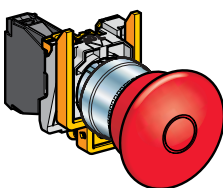

Push-pull

XB4 BT42/BT845
see page 36002/3

Turn to release

XB4 BS542/BS8445
see page 36002/3

Key release

XB4 BS142/BS9445
see page 36002/3

Selector switches and key switches

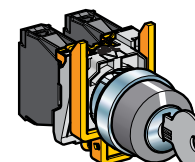
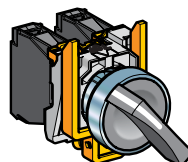
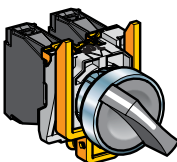

Standard black handle

XB4 BD
see page 36002/3

Long black handle

XB4 BJ
see page 36002/3

Key switches

XB4 BG
see page 36002/3

Complete units

Signalling functions

Pilot lights

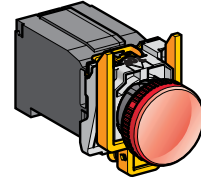
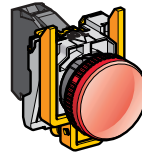
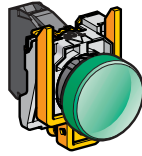

With integral LED

[XB4 BVB/BVG/BVM](#)
see page 36003/2

For BA 9s bulb
Direct supply

[XB4 BV6](#)
see page 36003/3

Via integral transformer

[XB4 BV3/BV4](#)
see page 36003/3

Combined functions (contact + signalling)

Illuminated pushbuttons, spring return, flush push

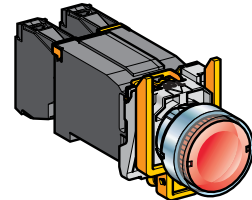
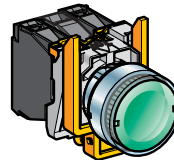
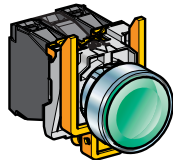

With integral LED

[XB4 BW3•B5/BW3•G5/BW3•M5](#)
see page 36004/2

For BA 9s bulb
Direct supply

[XB4 BW3•65](#)
see page 36004/2

Via integral transformer

[XB4 BW3•35/BW3•45](#)
see page 36004/3

Double-headed pushbuttons, spring return, with pilot light

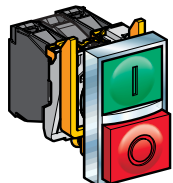

With integral LED

[XB4 BW84•5](#)
see page 36004/3

Illuminated selector switches, standard handle

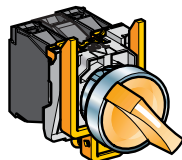

With integral LED

[XB4 BK12•B5/BK12•G5/BK12•M5](#)
see page 36004/3

Control and signalling units Ø 22

Harmony® style 4

Pushbuttons, switches and pilot lights with chromium plated metal bezel

Sub-assemblies, ZB4 B

Non illuminated units for user assembly

For pushbuttons, spring return, without marking

Body sub-assemblies

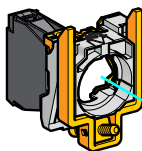

Screw clamp terminals

ZB4 BZ10/BZ141
see page 36005/2

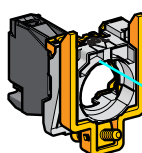

Plug-in connector

ZB4 BZ10/4/BZ1414
see page 36005/2

For pushbuttons, spring return, with marking

For "push-push to release" pushbuttons

For double-headed pushbuttons, spring return

Contact functions

Head sub-assemblies

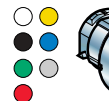

Flush push without cap

ZB4 BA0
see page 36005/3

Flush push with set of 6 caps

ZB4 BA9
see page 36005/3

Flush push

ZB4 BA
see page 36005/3

Flush push for insertion of legend

ZB4 BA8
see page 36005/3



Projecting push

ZB4 BL
see page 36005/3

Recessed push

ZB4 BA6
see page 36005/3

Booted flush push

ZB4 BP
see page 36005/3

Booted flush push for insertion of legend

ZB4 BP8
see page 36005/3



Flush push

ZB4 BA3/4
ZB4 BA334/335
see page 36005/4

Projecting push

ZB4 BL3
see page 36005/4



Flush push

ZB4 BH0
see page 36005/4

Projecting push

ZB4 BH
see page 36005/4

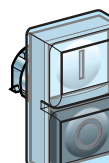

Flush pushes (IP 40/IP 66)
Without/with marking

ZB4 BA81
ZB4 BA82
see page 36005/5

ZB4 BA91
ZB4 BA92
see page 36005/5

Flush push + projecting push (IP 40/IP 66)
Without/with marking

ZB4 BL83
ZB4 BL84
see page 36005/5

ZB4 BL93
ZB4 BL94
see page 36005/5

Control and signalling units Ø 22

Harmony® style 4

Pushbuttons, switches and pilot lights with chromium plated metal bezel

Sub-assemblies, ZB4 B

Non illuminated units for user assembly (continued)

Contact functions

For mushroom head pushbuttons, spring return

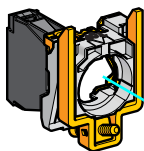

Screw clamp terminals
ZB4 BZ10/BZ141
see page 36005/2

Head sub-assemblies

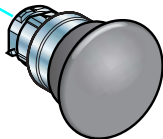

Ø 30
Ø 40
Ø 60

Spring return
ZB4 BC/BR
see page 36005/6

For mushroom head pushbuttons, latching, with or without trigger action

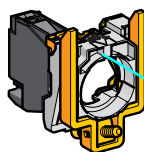

Plug-in connector
ZB4 BZ10/4/BZ1414
see page 36005/2

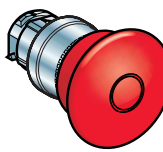

Ø 40
Ø 60

Push-pull
ZB4 BT84, ZB4 BT/BX
see page 36005/7

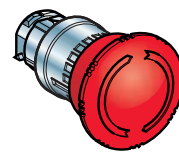

Ø 30
Ø 40
Ø 60

Turn to release
ZB4 BS8/4, ZB4 BS4/BS5/BS6
see page 36005/7

For selector switches and key switches

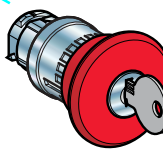

Ø 30
Ø 40
Ø 60

Key release
ZB4 BS9/4/BS7/BS1/BS2
see page 36005/7



Standard black handle (1)
ZB4 BD
see page 36005/8



Long black handle (1)
ZB4 BJ
see page 36005/8



Knurled black knob (1)
ZB4 BDe3
see page 36005/8



Key switch (2)
ZB4 BG
see page 36005/9

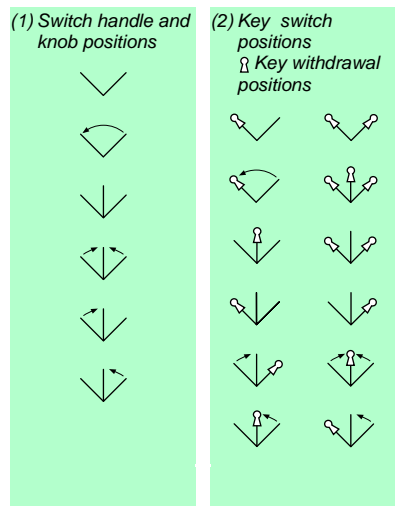

For toggle switches

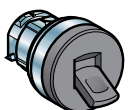

2-position
ZB4 BDø8
see page 36009/2

Control and signalling units Ø 22

Harmony® style 4

Pushbuttons, switches and pilot lights with chromium plated metal bezel

Sub-assemblies, ZB4 B

Pilot lights for user assembly

Signalling functions

Body sub-assemblies with integral LED

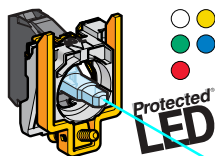

Screw clamp terminals

ZB4 BV \bullet B/BVG/BVM
see page 36006/2

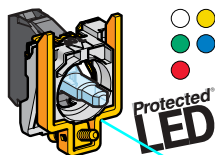

Plug-in connector

ZB4 BV \bullet B \bullet 4/BVG \bullet 4/
BVM \bullet 4
see page 36006/2

Head sub-assemblies



With lens mounted

ZB4 BV0 \bullet 3
see page 36006/3

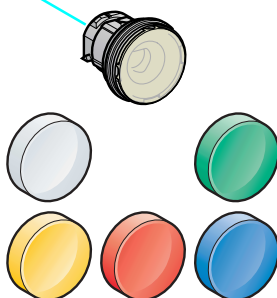

With 5 separate lenses not mounted

ZB4 BV003
see page 36006/3

Body sub-assemblies for BA 9s bulb

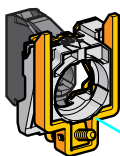

Direct supply Screw clamp terminals

ZB4 BV6
see page 36006/3

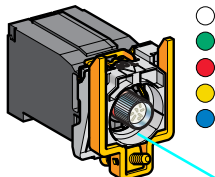

Via integral transformer Screw clamp terminals

ZB4 BV \bullet /BV3D \bullet /
BV5D \bullet see page
36006/3

Head sub-assemblies



With lens mounted

ZB4 BV0 \bullet 2
see page 36006/3

Control and signalling units Ø 22

Harmony® style 4

Pushbuttons, switches and pilot lights with chromium plated metal bezel

Sub-assemblies, ZB4 B

Illuminated pushbuttons for user assembly

For illuminated pushbuttons, spring return

Body sub-assemblies with integral LED

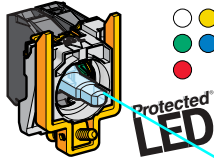

Screw clamp terminals
ZB4 BW0B/BW0G/
BW0M see pages
36007/2 and 36022/3

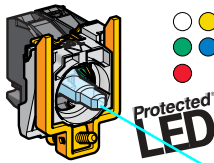

Plug-in connector
ZB4 BW0Bpp4/
BW0Gee4/BW0Mee4
see pages 36007/4 and
36023/3

For double-headed pushbuttons, spring return, with pilot light

For illuminated, "push-push to release" pushbuttons and illuminated selector switches with standard handle

Body sub-assemblies for BA9s bulb

For illuminated pushbuttons, spring return



Direct supply
Screw clamp terminals
ZB4 BW06
see pages 36007/6

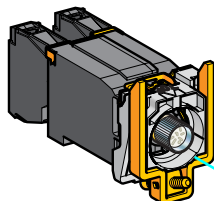

Via integral transformer
Screw clamp terminals
ZB4 BW03/4/5/3D/5D
see pages 36007/6

Combined functions (contact + signalling)

Head sub-assemblies



Flush push
ZB4 BW3p3
see page 36007/7

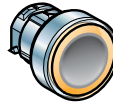

Flush push with illuminated ring
ZB4 BW9e3
see page 36007/7



Flush push for insertion of legend
ZB4 BAe8
see page 36007/7



Booted flush push
ZB4 BW5e3
see page 36007/7



Projecting push
ZB4 BW1e3
see page 36007/7

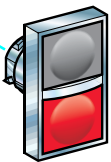

Flush push
Without/with marking
ZB4 BW81ee3
see page 36007/8



ZB4 BW82ee3
see page 36007/8

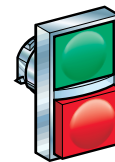

Flush push + projecting push
Without/with marking
ZB4 BW83ee3
see page 36007/8

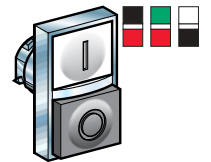

ZB4 BW84ee3
see page 36007/8



Flush or projecting "push-push to release"
ZB4 BH0e3/BHe3
see page 36007/8



Selector switches with standard handle
ZB4 BK1ee3
see page 36007/9

Head sub-assemblies



Flush push
ZB4 BW3
see page 36007/7



Projecting push
ZB4 BW1
see page 36007/7

Environment			
Protective treatment standard version			"TH"
Ambient air temperature around the device	Storage	°C	- 40...+ 70
	Operation	°C	- 25...+ 70 unless otherwise stated
Electric shock protection	Conforming to IEC 60536		Class I
Degree of protection	Conforming to IEC 60529		IP 65, unless otherwise stated IP 66, for booted pushbutton heads
	Conforming to NEMA		NEMA type 4X and 13, unless otherwise stated
Resistance to high pressure washer		Pa	70 x 10 ⁵ (70 bar); distance: 0.1 m Temperature: 55°C
Mechanical shock protection	Conforming to IEC 50102		Non illuminated heads: IK 03
			Illuminated heads: IK 05
Conforming to standards			IEC/EN 60947-1, IEC/EN 60947-5-1, IEC/EN 60947-5-4, JIS C 4520, UL 508, CSA C22-2 n° 14
Product certifications	UL Listed, CSA		Standard single contact blocks with screw clamp terminals: A600; Q600 Double contact blocks with screw clamp terminals: A600; Q600 Light blocks with screw clamp terminals Joystick controllers XD4 PA/ZD4 PA: A600; R300
	UL Recognized, CSA		Standard single contact blocks for plug-in connector: A300; R300 Standard contact blocks for printed circuit board: B300; R300
	BV, RINA, LROS, DNV, GL (pending)		Standard single and double contact blocks with screw clamp terminals:
Terminal identification	Conforming to EN 50005 and EN 50013		

Characteristics of contact or combined contact and signalling functions			
Mechanical characteristics			
Contact operation	N/C or N/O		Slow break
Positive operation	Conforming to IEC/EN 60947-5-1 appendix K		All functions incorporating a N/C contact are positive opening operation
Operating travel (to change the electrical state)	Pushbutton	mm	Changing N/C state: 1.5 Changing N/O state: 2.6 Total travel: 4.3
			Operating force
Operating force	Additional contact (extra to change state)	N	Single N/C contact: 2 Single N/O contact: 2.3
			N
	Emergency stop with N/C + N/O	N	Standard push-pull: 45 Trigger action push-pull: 50
N			Standard turn to release and key release: 40 Trigger action turn to release and key release: 44

Characteristics of contact or combined contact and signalling functions (continued)

Mechanical characteristics (continued)

Operating torque (to change the electrical state)	Selector switches	N.m	N/O contact: 0.14
	Additional contact (extra)	N.m	N/O contact: 0.05
Mechanical durability (in millions of operating cycles)	Pushbuttons	Spring return	5
		Double-headed	1
		Push-push to release	0.5
	Selector switches	Non illuminated	3
		Illuminated	1
	Toggle switches		0.5
	Emergency stop pushbuttons		0.3
	Joystick controllers		1
	Standard contact blocks only		5
	Low power switching contact blocks only (dust protected)		0.5
Vibration resistance	Conforming to IEC 60068-2-6	gn	Frequency: 2 to 500 Hz: 5
Electric shock resistance	Conforming to IEC 60068-2-27	gn	All functions except mushroom head pushbuttons half sine wave acceleration 11 ms: 50 half sine wave acceleration 18 ms: 30
		gn	Mushroom head pushbutton (half sine wave acceleration 11 ms: 10)
Electrical characteristics			
Cabling capacity	Conforming to IEC 60947-1	mm²	Screw clamp terminals Min: 1 x 0.22 without cable end Max: 2 x 1.5 with cable end Cross headed screw (Pozidrive or Philips type 1), slotted for flat 4 and 5.5 mm screwdriver Tightening torque: 0.8 N.m (max 1.2 N.m)
Contact material	Silver alloy (Ag / Ni)		Standard single and double blocks with screw clamp terminals Blocks for plug-in connector Standard blocks for printed circuit board connection
	Gold flashed (Ag / Ni / Au)		Low power switching contact blocks with screw clamp terminals Low power switching contact blocks for printed circuit board connection
Short-circuit protection	Conforming to IEC/EN 60947-5-1	A	Standard single and double blocks with screw clamp terminals: 10 (gG cartridge fuse conforming to IEC 60269-1) Blocks for plug-in connector: 4 (gG cartridge fuse conforming to IEC 60269-1) Standard blocks for printed circuit board connection: 4 (gG cartridge fuse conforming to IEC 60269-1)
Rated thermal current	Conforming to IEC/EN 60947-5-1	A	Standard single and double blocks with screw clamp terminals: 10 Blocks for plug-in connector: 10 Standard blocks for printed circuit board connection: 6
Rated insulation voltage	Conforming to IEC 60947-1	V	Standard single and double blocks with screw clamp terminals: Ui = 600 degree of pollution 3 Blocks for plug-in connector or Faston connectors: Ui = 250 degree of pollution 3 Standard blocks for printed circuit board connection: Ui = 250 degree of pollution 3
Rated impulse withstand voltage	Conforming to IEC 60947-1	kV	Standard single and double blocks with screw clamp terminals: Uimp = 6 Blocks for plug-in connector: Uimp = 4 Standard blocks for printed circuit board connection: Uimp = 4

Characteristics of contact or combined contact and signalling functions (continued)

Electrical characteristics (continued)

Rated operational characteristics

Conforming to IEC/EN 60947-5-1

	a.c. supply: utilisation category AC-15	Standard single and double blocks with screw clamp terminals: A600: Ue = 600 V and Ie = 1.2 A or Ue = 240 V and Ie = 3 A or Ue = 120 V and Ie = 6 A Blocks for plug-in connector: A300: Ue = 120 V and Ie = 6 A or Ue = 240 V and Ie = 3 A Standard blocks for printed circuit board connection: B300: Ue = 120 V and Ie = 3 A or Ue = 240 V and Ie = 1.5 A
	d.c. supply: utilisation category DC-13	Standard single and double blocks with screw clamp terminals: Q600: Ue = 600 V and Ie = 0.1 A or Ue = 250 V and Ie = 0.27 A or Ue = 125 V and Ie = 0.55 A Joystick controllers XD4 PA/ZD4 PA: R300: Ue = 125 V and Ie = 0.22 A or Ue = 250 V and Ie = 0.1 A Blocks for plug-in connector: R300: Ue = 125 V and Ie = 0.22 A or Ue = 250 V and Ie = 0.1 A Standard blocks for printed circuit board connection: R300: Ue = 125 V and Ie = 0.22 A or Ue = 250 V and Ie = 0.1 A
Characteristics of special contact blocks for low power switching		VA P max: 12 A I max: 0.1 V U max: 24
Electrical durability Conforming to IEC/EN 60947-5-1 appendix C Operating rate 3600 operating cycles/hour Load factor: 0.5	a.c. supply for 1 million operating cycles utilisation category AC-15	Standard single blocks with screw clamp terminals: V 24 120 230 A 4 3 2
		Standard double blocks with screw clamp terminals and blocks for plug-in connector: V 24 120 230 A 3 1.5 1
	d.c. supply for 1 million operating cycles utilisation category DC-13	Standard single blocks with screw clamp terminals: V 24 110 A 0.5 0.2
		Standard double blocks with screw clamp terminals and blocks for plug-in connector: V 24 110 A 0.4 0.15
Electrical reliability	Failure rate Conforming to IEC/EN 60947-5-4 - In clean environment	Standard blocks: - at 17 V and 5 mA, $\lambda < 10^{-8}$ - at 5 V and 1 mA, $\lambda < 10^{-6}$ Special blocks with gold flashed contacts, for low power switching - at 5 V and 1 mA, $\lambda < 10^{-7}$
	- In dusty environment	Special blocks with gold flashed contacts and dust protection for low power switching only: - at 5 V and 1 mA, $\lambda < 10^{-7}$

Characteristics of signalling units (pilot lights)

Mechanical characteristics

Vibration resistance	Conforming to IEC 60068-2-6	gn	Frequency: 12 to 500 Hz: 5
Electric shock resistance	Conforming to IEC 60068-2-27	gn	Half sine wave acceleration 11 ms: 50 Half sine wave acceleration 18 ms: 30

Electrical characteristics

Cabling capacity	Conforming to IEC 60947-1	mm ²	Screw clamp terminals Min: 1 x 0.22 without cable end (1 x 0.34 for linking) Max: 2 x 1.5 with cable end
Rated insulation voltage	Conforming to IEC 60947-1	V	Direct supply pilot light blocks (BA 9s bulb): U _i = 250 degree of pollution 3 Pilot light blocks with integral LED: U _i = 250 degree of pollution 3 Pilot light blocks with transformer: U _i = 600 degree of pollution 3
Rated impulse withstand voltage	Conforming to IEC 60947-1	kV	Direct supply pilot light blocks (BA 9s bulb): U _{imp} = 4 Pilot light blocks with integral LED: U _{imp} = 4 Pilot light blocks with transformer: U _{imp} = 6

Specific characteristics of single light blocks with integral LED

Voltage limits	For rated voltage	V	12 V: 10 to 15 $\overline{=}$; 10.2 to 13.8 \sim 24 V: 19.2 to 30 $\overline{=}$; 21.6 to 26.4 \sim 24 to 120 V: 20 to 132 \approx 48 to 120 V: 40 to 132 \sim 240 V: 195 to 264 \sim
Current consumption	Applicable to all colours	mA	Blocks with \approx 12 V supply: 18 Blocks with \approx 24 V supply: 18 Blocks with \sim 120 V supply: 14 Blocks with \sim 240 V supply: 14
Service life	At rated voltage and at an ambient temperature of 25 °C	H	100 000
Surge withstand	Conforming to IEC 61000-4-5	kV	1
Resistance to fast transients	Conforming to IEC 61000-4-4	kV	2
Resistance to electromagnetic fields	Conforming to IEC 61000-4-3	V/m	10
Resistance to electrostatic discharges	Conforming to IEC 61000-2-6	kV	8/6
Direct parallel connection across inductive load e.g.: contactor coil or solenoid	Maximum power of load	VA	For high power applications (\geq 30 VA), a ZBZ V● LED suppressor must be connected across the light block terminals (see page 36008/3)
Electromagnetic emission	Conforming to IEC 55011		Class B

Specific characteristics

Body/fixing collar

Tightening torque of fixing screw		N.m	0.8 (max 1.2)
-----------------------------------	--	-----	---------------

Hour counters and annunciators

Voltage limits	Hour counter and annunciator		\pm 10% of the rated voltage
Current consumption	Hour counter	mA	XB5 DSB : 7 to 15 XB5 DSG : 8 XB5 DSM : 8
	Annunciator	mA	5

References

User assembly of other units
using body + head sub-assemblies:
see pages 36005/2 to 36005/6









Control and signalling units Ø 22

Harmony® style 4

Pushbuttons and switches with chromium plated metal bezel

Complete units, XB4 B

Pushbuttons, spring return (screw clamp terminal connections)

Shape of head	Type of push	Type of contact		Marking	Colour of push	Reference	Weight
		N/O	N/C				
	Flush	1	-	-	Black	XB4 BA21 (ZB4 BZ101 + ZB4 BA2)	0.080
					Green	XB4 BA31 (ZB4 BZ101 + ZB4 BA3)	0.080
					Yellow	XB4 BA51 (ZB4 BZ101 + ZB4 BA5)	0.080
					Blue	XB4 BA61 (ZB4 BZ101 + ZB4 BA6)	0.080
		-	1	-	Red	XB4 BA42 (ZB4 BZ102 + ZB4 BA4)	0.080
	Flush	1	-	"I" (white)	Green	XB4 BA3311 (ZB4 BZ101 + ZB4 BA331)	0.080
	Flush	-	1	"O" (white)	Red	XB4 BA4322 (ZB4 BZ102 + ZB4 BA432)	0.080
	Flush (1)	1	-	↑ (black)	White	XB4 BA3341 (ZB4 BZ101 + ZB4 BA334)	0.080
	Flush (1)	1	-	↑ (white)	Black	XB4 BA3351 (ZB4 BZ101 + ZB4 BA335)	0.080
	Booted (clear silicone) (colour of push unobscured)	1	-	-	Black	XB4 BP21 (ZB4 BZ101 + ZB4 BP2)	0.082
					Green	XB4 BP31 (ZB4 BZ101 + ZB4 BP3)	0.082
					Yellow	XB4 BP51 (ZB4 BZ101 + ZB4 BP5)	0.082
					Blue	XB4 BP61 (ZB4 BZ101 + ZB4 BP6)	0.082
		-	1	-	Red	XB4 BP42 (ZB4 BZ102 + ZB4 BP4)	0.082
	Projecting	-	1	-	Red	XB4 BL42 (ZB4 BZ102 + ZB4 BL4)	0.081
	Mushroom head Ø 40	1	-	-	Black	XB4 BC21 (ZB4 BZ101 + ZB4 BC2)	0.122

Double-headed pushbuttons, spring return (screw clamp terminal connections)

Shape of head	Description	Type of contact		Degree of protection	Reference	Weight
		N/O	N/C			
	1 green flush push (marked "I") 1 red projecting push (marked "O")	1	1	IP 40	XB4 BL845 (ZB4 BZ105 + ZB4 BL8434)	0.106
				IP 66	XB4 BL945 (ZB4 BZ105 + ZB4 BL9434)	0.111

(1) Product supplied with cap not clipped-in, allowing orientation through 360° in 90° steps.

814084



XB4 BA31

814085



XB4 BA4322

814086



XB4 BP51

814087



XB4 BL42

814088



XB4 BC21

814089



XB4 BL845

User assembly of other units
using body + head assemblies :
see pages 36005/7 to 36005/9





Control and signalling units Ø 22

Harmony® style 4



Pushbuttons and switches with chromium plated metal bezel

Complete units, XB4 B

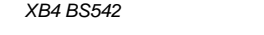
Emergency stop mushroom head pushbuttons, Ø 40 (red) (screw clamp terminal connections)

Shape of head	Type of push	Type of contact		Reference	Weight
		N/O	N/C		
 XB4 BT845	Trigger action Push-pull	1	1	XB4 BT845 (ZB4 BZ105 + ZB4 BT84)	0.136
		1	1		
 XB4 BS8445	Trigger action Turn to release	1	1	XB4 BS8445 (ZB4 BZ105 + ZB4 BS844)	0.130
		–	2		
		1	2		
 XB4 BS9445	Trigger action Key release (Key n° 455)	1	1	XB4 BS9445 (ZB4 BZ105 + ZB4 BS944)	0.170
		–	1		
 XB4 BT42	Push-pull	–	1	XB4 BT42 (ZB4 BZ102 + ZB4 BT4)	0.125
		–	1		
		–	1		
 XB4 BS542	Turn to release	–	1	XB4 BS542 (ZB4 BZ102 + ZB4 BS54)	0.118
		–	1		
 XB4 BS142	Key release (key n° 455)	–	1	XB4 BS142 (ZB4 BZ102 + ZB4 BS14)	0.133
		–	1		

Selector switches and key switches (screw clamp terminal connections)

Shape of head	Type of operator	Type of contact		Number and type of positions (1)	Reference	Weight
		N/O	N/C			
 XB4 BD33	Standard handle, black	1	–	2 - stay put	XB4 BD21 (ZB4 BZ101 + ZB4 BD2)	0.095
		1	1	2 - stay puts		
		2	–	3 - stay put		
 XB4 BJ33	Long handle, black	1	–	2 - stay put	XB4 BJ21 (ZB4 BZ101 + ZB4 BJ2)	0.096
		2	–	3 - stay put		
		–	–	3 - spring return to centre		
 XB4 BG33	Key (n° 455)	1	–	2 - stay put	XB4 BG21 (ZB4 BZ101 + ZB4 BG2)	0.117
		–	–	2 - spring return to left		
		–	–	2 - stay puts	XB4 BG41 (ZB4 BZ101 + ZB4 BG4)	0.117
		–	–	2 - spring return to left		
		2	–	3 - stay put		
–	–	3 - stay puts	XB4 BG61 (ZB4 BZ101 + ZB4 BG6)	0.117		
–	–	3 - stay puts	XB4 BG03 (ZB4 BZ103 + ZB4 BG0)	0.127		
–	–	3 - stay puts	XB4 BG33 (ZB4 BZ103 + ZB4 BG3)	0.127		

(1) The symbol  indicates key withdrawal position(s).

Control and signalling units Ø 22

Harmony® style 4
Pilot lights, with chromium plated metal bezel
Complete units, XB4-B



XB4-BVB5

Pilot lights with integral LED (screw clamp terminal connections)

Shape of head	Supply voltage	Colour	Reference	Weight
	V			kg
	~ 24	White	XB4-BVB1 (ZB4-BVB1 + ZB4-BV013)	0.080
		Green	XB4-BVB3 (ZB4-BVB3 + ZB4-BV033)	0.080
		Red	XB4-BVB4 (ZB4-BVB4 + ZB4-BV043)	0.080
		Yellow	XB4-BVB5 (ZB4-BVB5 + ZB4-BV053)	0.080
		Blue	XB4-BVB6 (ZB4-BVB6 + ZB4-BV063)	0.080
		~ 48...120	White	XB4-BVG1 (ZB4-BVG1 + ZB4-BV013)
	Green	XB4-BVG3 (ZB4-BVG3 + ZB4-BV033)	0.080	
	Red	XB4-BVG4 (ZB4-BVG4 + ZB4-BV043)	0.080	
	Yellow	XB4-BVG5 (ZB4-BVG5 + ZB4-BV053)	0.080	
	Blue	XB4-BVG6 (ZB4-BVG6 + ZB4-BV063)	0.080	
	~ 230...240	White	XB4-BVM1 (ZB4-BVM1 + ZB4-BV013)	0.080
	Green	XB4-BVM3 (ZB4-BVM3 + ZB4-BV033)	0.080	
	Red	XB4-BVM4 (ZB4-BVM4 + ZB4-BV043)	0.080	
	Yellow	XB4-BVM5 (ZB4-BVM5 + ZB4-BV053)	0.080	
	Blue	XB4-BVM6 (ZB4-BVM6 + ZB4-BV063)	0.080	

Pilot lights for BA 9s bulb (screw clamp terminal connections)

Shape of head	Supply voltage V	Colour	Reference	Weight kg
---------------	---------------------	--------	-----------	--------------

Direct supply, for BA 9s U ≤ 250 V, 2.4 W bulb (bulb not included, see page 36008/14)

	≤ 250	White	XB4-BV61 (ZB4-BV6 + ZB4-BV01)	0.075
		Green	XB4-BV63 (ZB4-BV6 + ZB4-BV03)	0.075
		Red	XB4-BV64 (ZB4-BV6 + ZB4-BV04)	0.075
		Yellow	XB4-BV65 (ZB4-BV6 + ZB4-BV05)	0.075



XB4-BV64

Via integral transformer with 1.2 VA, 6 V secondary. BA 9s incandescent bulb included

	~ 110...120 50/60 Hz	White	XB4-BV31 (ZB4-BV3 + ZB4-BV01)	0.152
		Green	XB4-BV33 (ZB4-BV3 + ZB4-BV03)	0.152
		Red	XB4-BV34 (ZB4-BV3 + ZB4-BV04)	0.152
		Yellow	XB4-BV35 (ZB4-BV3 + ZB4-BV05)	0.152
	~ 230 - 50 Hz ~ 220...240 - 60 Hz	White	XB4-BV41 (ZB4-BV4 + ZB4-BV01)	0.152
		Green	XB4-BV43 (ZB4-BV4 + ZB4-BV03)	0.152
		Red	XB4-BV44 (ZB4-BV4 + ZB4-BV04)	0.152
		Yellow	XB4-BV45 (ZB4-BV4 + ZB4-BV05)	0.152

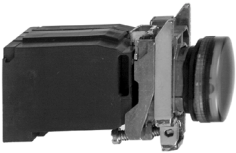

XB4-BV33

User assembly of other units using body + head sub-assemblies: see pages 36007/2 to 36007/7





Control and signalling units Ø 22

Harmony® style 4

Illuminated pushbuttons and switches with chromium plated metal bezel

Complete units, XB4 B

Illuminated pushbuttons, spring return, flush push

Shape of head	Description	Type of contact		Supply voltage	Colour of push	Reference	Weight	
								
		N/O	N/C	V			kg	
	Screw clamp terminal connections Integral LED 	1	1	≈ 24	White	XB4 BW31B5 (ZB4 BW0B15 + ZB4 BW313)	0.097	
					Green	XB4 BW33B5 (ZB4 BW0B35 + ZB4 BW333)	0.097	
					Red	XB4 BW34B5 (ZB4 BW0B45 + ZB4 BW343)	0.097	
					Yellow	XB4 BW35B5 (ZB4 BW0B55 + ZB4 BW353)	0.097	
					Blue	XB4 BW36B5 (ZB4 BW0B65 + ZB4 BW363)	0.097	
					~ 48...120	White	XB4 BW31G5 (ZB4 BW0G15 + ZB4 BW313)	0.097
					Green	XB4 BW33G5 (ZB4 BW0G35 + ZB4 BW333)	0.097	
					Red	XB4 BW34G5 (ZB4 BW0G45 + ZB4 BW343)	0.097	
					Yellow	XB4 BW35G5 (ZB4 BW0G55 + ZB4 BW353)	0.097	
					Blue	XB4 BW36G5 (ZB4 BW0G65 + ZB4 BW363)	0.097	
		1	1	~ 230...240	White	XB4 BW31M5 (ZB4 BW0M15 + ZB4 BW313)	0.097	
					Green	XB4 BW33M5 (ZB4 BW0M35 + ZB4 BW333)	0.097	
					Red	XB4 BW34M5 (ZB4 BW0M45 + ZB4 BW343)	0.097	
					Yellow	XB4 BW35M5 (ZB4 BW0M55 + ZB4 BW353)	0.097	
					Blue	XB4 BW36M5 (ZB4 BW0M65 + ZB4 BW363)	0.097	
					Direct supply, for BA 9s 2.4 W max bulb not included	1	1	≤ 250
Green	XB4 BW3365 (ZB4 BW065 + ZB4 BW33)	0.097						
Red	XB4 BW3465 (ZB4 BW065 + ZB4 BW34)	0.097						
Yellow	XB4 BW3565 (ZB4 BW065 + ZB4 BW35)	0.097						

References (continued)

User assembly of other units using body + head sub-assemblies: see pages 36007/2 to 36007/9

Control and signalling units Ø 22

Harmony® style 4

Illuminated pushbuttons and switches with chromium plated metal bezel

Complete units, XB4 B

Illuminated pushbuttons, spring return, flush push (continued)

Shape of head	Description	Type of contact		Supply voltage	Colour of push	Reference	Weight
		N/O	N/C				
 XB4 BW3545	Screw clamp terminal connections Via integral transformer 1.2 VA 6 V secondary, BA 9s incandescent bulb included	1	1	~ 110...120 50/60 Hz	White	XB4 BW3135 (ZB4 BW035 + ZB4 BW31)	0.169
					Green	XB4 BW3335 (ZB4 BW035 + ZB4 BW33)	0.169
					Red	XB4 BW3435 (ZB4 BW035 + ZB4 BW34)	0.169
					Yellow	XB4 BW3535 (ZB4 BW035 + ZB4 BW35)	0.169
					White	XB4 BW3145 (ZB4 BW045 + ZB4 BW31)	0.170
					Green	XB4 BW3345 (ZB4 BW045 + ZB4 BW33)	0.170
					Red	XB4 BW34M5 (ZB4 BW045 + ZB4 BW34)	0.170
					Yellow	XB4 BW3545 (ZB4 BW045 + ZB4 BW35)	0.170
					White	XB4 BW3145 (ZB4 BW045 + ZB4 BW31)	0.170
					Green	XB4 BW3345 (ZB4 BW045 + ZB4 BW33)	0.170
					Red	XB4 BW34M5 (ZB4 BW045 + ZB4 BW34)	0.170
					Yellow	XB4 BW3545 (ZB4 BW045 + ZB4 BW35)	0.170

Double-headed pushbuttons, spring return, with integral LED pilot light (IP 40) (1)

Shape of head	Description	Type of contact		Supply voltage	Colour of push	Reference	Weight
		N/O	N/C				
 XB4 BW84B5	Screw clamp terminal connections 1 flush green push (marked "I") 1 yellow pilot light 1 projecting red push (marked "O") Protected LED	1	1	≈ 24	–	XB4 BW84B5 (ZB4 BW0B55 + ZB4 BW843743)	0.116
					–	XB4 BW84G5 (ZB4 BW0G55 + ZB4 BW843743)	0.116
					–	XB4 BW84M5 (ZB4 BW0M55 + ZB4 BW843743)	0.116

Illuminated selector switches with integral LED (2-position stay put)

Shape of head	Type of operator	Type of contact		Supply voltage	Colour of handle	Reference	Weight
		N/O	N/C				
 XB4 BK124B5	Standard handle Protected LED	1	1	≈ 24	Green	XB4 BK123B5 (ZB4 BW0B35 + ZB4 BK1233)	0.111
					Red	XB4 BK124B5 (ZB4 BW0B45 + ZB4 BK1243)	0.111
					Yellow	XB4 BK125B5 (ZB4 BW0B55 + ZB4 BK1253)	0.111
					Green	XB4 BK123G5 (ZB4 BW0G35 + ZB4 BK1233)	0.111
					Red	XB4 BK124G5 (ZB4 BW0G45 + ZB4 BK1243)	0.111
					Yellow	XB4 BK125G5 (ZB4 BW0G55 + ZB4 BK1253)	0.111
					Green	XB4 BK123M5 (ZB4 BW0M35 + ZB4 BK1233)	0.111
					Red	XB4 BK124M5 (ZB4 BW0M45 + ZB4 BK1243)	0.111
					Yellow	XB4 BK125M5 (ZB4 BW0M55 + ZB4 BK1253)	0.111

(1) For IP 66 degree of protection, fit a clear sealing boot: **ZBW 008** or **ZBW 008A**. See page 36008/15.

References

To combine with heads:
see pages 36005/3 to 36005/9

Control and signalling units Ø 22

Harmony® style 4

Pushbuttons and switches with chromium plated metal bezel

Sub-assemblies ZB4 B : bodies



814133

ZB4 BZ101

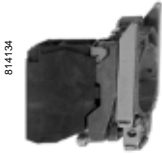

814134

ZB4 BZ102



814135

ZB4 BZ1014

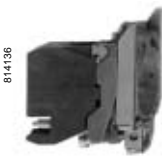

814136

ZB4 BZ1024

Complete bodies (fixing collar + single contact block)

Description	Type of contact		Reference	Weight kg
	N/O	N/C		
Screw clamp terminal connections	1	–	ZB4 BZ101	0.053
	–	1	ZB4 BZ102	0.053
	2	–	ZB4 BZ103	0.062
	–	2	ZB4 BZ104	0.062
	1	1	ZB4 BZ105	0.062
	1	2	ZB4 BZ141	0.072
Plug-in connector (1)	1	–	ZB4 BZ1014	0.050
	–	1	ZB4 BZ1024	0.050
	2	–	ZB4 BZ1034	0.058
	–	2	ZB4 BZ1044	0.058
	1	1	ZB4 BZ1054	0.058
	1	2	ZB4 BZ1414	0.064

Contact blocks

Description	Reference
Separate contact blocks	See page 36008/2

(1) Connecting cables and connector for plug-in connector contact blocks: see page 36008/4.

Other versions

Complete bodies with Faston connector terminals (6.35 or 2 x 2.8).
Please consult your Regional Sales Office.

Heads for spring return pushbuttons - unmarked



Shape of head	Type of push	Colour	Reference	Weight kg
	Without cap (1)	–	ZB4 BA0	0.028
	Flush, with set of 6 coloured caps	6 colours (2)	ZB4 BA9	0.038
	Flush	White	ZB4 BA1	0.029
		Black	ZB4 BA2	0.029
		Green	ZB4 BA3	0.029
		Red	ZB4 BA4	0.029
		Yellow	ZB4 BA5	0.029
		Blue	ZB4 BA6	0.029
	Grey	ZB4 BA8	0.029	
	Flush with transparent cap, for insertion of legend (3)	White	ZB4 BA18	0.028
		Green	ZB4 BA38	0.028
		Red	ZB4 BA48	0.028
		Yellow	ZB4 BA58	0.028
	Blue	ZB4 BA68	0.028	
	Booted (clear silicone) Colour of push unobscured	White	ZB4 BP1	0.031
		Black	ZB4 BP2	0.031
		Green	ZB4 BP3	0.031
		Red	ZB4 BP4	0.031
		Yellow	ZB4 BP5	0.031
		Blue	ZB4 BP6	0.031
	Booted (coloured silicone) can be replaced without dismantling the head, compatible with legend holder	White	ZB4 BP1S	0.034
		Black	ZB4 BP2S	0.034
		Green	ZB4 BP3S	0.034
		Red	ZB4 BP4S	0.034
		Yellow	ZB4 BP5S	0.034
		Blue	ZB4 BP6S	0.034
	Booted (clear silicone) for insertion of legend Colour of push unobscured	White	ZB4 BP18	0.034
		Green	ZB4 BP38	0.034
		Red	ZB4 BP48	0.034
		Yellow	ZB4 BP58	0.034
		Blue	ZB4 BP68	0.034
		White	ZB4 BL1	0.030
	Projecting	Black	ZB4 BL2	0.030
		Green	ZB4 BL3	0.030
		Red	ZB4 BL4	0.030
		Yellow	ZB4 BL5	0.030
		Blue	ZB4 BL6	0.030
		White	ZB4 BA14	0.034
	Flush (high guard)	Black	ZB4 BA24	0.034
		Green	ZB4 BA34	0.034
		Red	ZB4 BA44	0.034
		Yellow	ZB4 BA54	0.034
	Blue	ZB4 BA64	0.034	
	Recessed (high guard)	White	ZB4 BA16	0.034
		Black	ZB4 BA26	0.034
		Green	ZB4 BA36	0.034
		Red	ZB4 BA46	0.034
		Yellow	ZB4 BA56	0.034
	Blue	ZB4 BA66	0.034	

Heads with black metal bezel

To order, add the suffix 7 to the references selected above.
Example: ZB4 BA0 becomes ZB4 BA07.

(1) Coloured cap to be ordered separately: see page 36008/6.

(2) Head supplied with 6 different coloured caps (white, black, green, red, yellow, blue).

(3) For legend ordering information, see page 36008/12.

To combine with bodies:
see page 36005/2



Control and signalling units Ø 22

Harmony® style 4



Pushbuttons and switches with chromium plated metal bezel

Sub-assemblies ZB4 B : heads

Heads for spring return pushbuttons - marked

Shape of head	Type of push	Marking Text	Colour	Colour of push	Reference	Weight kg
	Flush	I	White	Green	ZB4 BA331	0.029
			Black	White	ZB4 BA131	0.029
		II	White	Green	ZB4 BA336	0.029
			Black	White	ZB4 BA136	0.029
		START	White	Green	ZB4 BA333	0.029
			Black	White	ZB4 BA133	0.029
		ON	White	Green	ZB4 BA341	0.029
			Black	White	ZB4 BA141	0.029
		MARCHE	White	Green	ZB4 BA342	0.029
			Black	White	ZB4 BA142	0.029
			White	Black	ZB4 BA245	0.029
			Black	White	ZB4 BA145	0.029
		O	White	Red	ZB4 BA432	0.029
				Black	ZB4 BA232	0.029
		ARRET	White	Red	ZB4 BA433	0.029
				Black	ZB4 BA233	0.029
		STOP	White	Red	ZB4 BA434	0.029
				Black	ZB4 BA234	0.029
		OFF	White	Red	ZB4 BA435	0.029
				Black	ZB4 BA235	0.029
↑ (1)	White	Black	ZB4 BA335	0.029		
		Black	White	ZB4 BA334	0.029	
	Projecting	O	White	Red	ZB4 BL432	0.030
			Black	ZB4 BL232	0.030	
		ARRET	White	Red	ZB4 BL433	0.030
				Black	ZB4 BL233	0.030
		STOP	White	Red	ZB4 BL434	0.030
				Black	ZB4 BL234	0.030
		OFF	White	Red	ZB4 BL435	0.030
				Black	ZB4 BL235	0.030

Heads for "push-push to release" pushbuttons (2)

Shape of head	Type of push	Colour of push	Reference	Weight kg
	Flush	White	ZB4 BH01	0.029
		Black	ZB4 BH02	0.029
		Green	ZB4 BH03	0.029
		Red	ZB4 BH04	0.029
		Yellow	ZB4 BH05	0.029
		Blue	ZB4 BH06	0.029
	Projecting	White	ZB4 BH1	0.029
		Black	ZB4 BH2	0.029
		Green	ZB4 BH3	0.029
		Red	ZB4 BH4	0.029
		Yellow	ZB4 BH5	0.029
		Blue	ZB4 BH6	0.029

Heads with black metal bezel

To order, add the suffix 7 to the references selected above.
Example: ZB4 BA331 becomes ZB4 BA3317.

(1) Head supplied with cap not clipped-in, allowing orientation through 360° in 90° steps.
(2) Maximum of 1 row of 3 contact blocks on associated body/fixing collar sub-assembly.



To combine with bodies:
see page 36005/2

Control and signalling units Ø 22

Harmony® style 4

Pushbuttons and switches with chromium plated metal bezel

Sub-assemblies ZB4 B : heads

Heads for double-headed, spring return pushbuttons

Shape of head	Description	Colour of pushes	Degree of protection	Reference	Weight kg
---------------	-------------	------------------	----------------------	-----------	-----------

Without function marking on pushes

	2 flush pushes	Green Red	IP 40 (1)	ZB4 BA8134	0.047
			IP 66	ZB4 BA9134	0.052
		White Black	IP 40 (1)	ZB4 BA8112	0.047
			IP 66	ZB4 BA9112	0.052



	1 flush push 1 projecting push	Green Red	IP 40 (1)	ZB4 BL8334	0.046
			IP 66	ZB4 BL9334	0.051
		White Black	IP 40 (1)	ZB4 BL8312	0.046
			IP 66	ZB4 BL9312	0.051



With function marking on pushes

	2 flush pushes (marked "I") (marked "O")	Green Red	IP 40 (1)	ZB4 BA8234	0.047
			IP 66	ZB4 BA9234	0.052
		White Black	IP 40 (1)	ZB4 BA8212	0.047
			IP 66	ZB4 BA9212	0.052



	1 flush push (marked "I") 1 projecting push (marked "O")	Green Red	IP 40 (1)	ZB4 BL8434	0.046
			IP 66	ZB4 BL9434	0.051
		White Black	IP 40 (1)	ZB4 BL8412	0.046
			IP 66	ZB4 BL9412	0.051



Heads with black metal bezel

To order, add the suffix 7 to the references selected above.
Example: **ZB4 BA8134** becomes **ZB4 BA81347**.

(1) NEMA type 1

To combine with bodies:
see page 36005/2





Control and signalling units Ø 22

Harmony® style 4

Pushbuttons and switches with chromium plated metal bezel

Sub-assemblies ZB4 B : heads





Mushroom heads for spring return pushbuttons

Shape of head	Diameter of push mm	Colour of push	Reference	Weight kg
	30	Black	ZB4 BC24	0.075
		Green	ZB4 BC34	0.075
		Red	ZB4 BC44	0.075
		Yellow	ZB4 BC54	0.075
		Blue	ZB4 BC64	0.075
	40	Black	ZB4 BC2	0.074
		Green	ZB4 BC3	0.074
		Red	ZB4 BC4	0.074
		Yellow	ZB4 BC5	0.074
		Blue	ZB4 BC6	0.074
	60	Black	ZB4 BR2	0.093
		Green	ZB4 BR3	0.093
		Red	ZB4 BR4	0.093
		Yellow	ZB4 BR5	0.093
		Blue	ZB4 BR6	0.093
	60 Hemispherical	Black	ZB4 BR216	0.054
		Green	ZB4 BR316	0.054
		Red	ZB4 BR416	0.054
		Yellow	ZB4 BR516	0.054
		Blue	ZB4 BR616	0.054

Heads with black metal bezel

To order, add the suffix 7 to the references selected above.
Example: ZB4 BC24 becomes ZB4 BC247.

Mushroom heads for latching pushbuttons (Emergency stop: colour red)

Shape of head	Type of push	Push Ø mm	Colour	Reference	Weight kg
	Trigger action Push-pull (1)	40	Red	ZB4 BT84	0.078
	Trigger action Turn to release (1)	30	Red	ZB4 BS834	0.068
		40	Red	ZB4 BS844	0.073
		60	Red	ZB4 BS864	0.093
	Trigger action Key release (key n° 455) (1) (3)	30	Red	ZB4 BS934	0.094
		40	Red	ZB4 BS944 (2)	0.098
		60	Red	ZB4 BS964	0.118
	Push-pull	40	Black	ZB4 BT2	0.077
			Red	ZB4 BT4	0.077
		60	Black	ZB4 BX2	0.095
			Red	ZB4 BX4	0.095
	Turn to release	30	Black	ZB4 BS42	0.066
			Red	ZB4 BS44	0.066
		40	Black	ZB4 BS52	0.070
			Red	ZB4 BS54	0.070
			Yellow	ZB4 BS55	0.070
			Black	ZB4 BS62	0.090
60	Red	ZB4 BS64	0.090		
	30	Black	ZB4 BS72	0.066	
Key release (key n° 455) (3)		Red	ZB4 BS74	0.066	
	40	Black	ZB4 BS12	0.070	
Red		ZB4 BS14 (2)	0.070		
60	Black	ZB4 BS22	0.090		
	Red	ZB4 BS24	0.090		



Heads with black metal bezel

To order, add the suffix **7** to the references selected above.
Example: **ZB4 BT84** becomes **ZB4 BT847**.

(1) Maximum number of contacts fitted to the associated body: 4.
Example: 4 single contact blocks, 2 double contact blocks, or 2 single contact blocks + 1 double contact block. See page 36008/2.





















(2) Other key numbers:

- key n° 421E: add suffix **12** to the reference.
- key n° 458A: add suffix **10** to the reference.
- key n° 520E: add suffix **14** to the reference.
- key n° 3131A: add suffix **20** to the reference.

Example: To order a Ø 40 red mushroom head for a trigger action, latching pushbutton, with release by key n° 421E, the reference becomes: **ZB4 BS94412**.

(3) For specific keys with other numbers, please consult your Regional Sales Office.

Heads for selector switches (1)

Shape of head	Type of operator	Number and type of positions	Reference	Weight kg		
  ZB4 BD4	Standard handle, black (2)	2 - stay put	 ZB4 BD2	0.044		
		2 - stay put with actuation of the centre contact	 ZB4 BD2M ▲	0.044		
		2 - spring return from right to left	 ZB4 BD4	0.044		
		2 - spring return from right to left with actuation of centre contact	 ZB4 BD4M ▲	0.044		
		3 - stay put	 ZB4 BD3	0.044		
		3 - spring return to centre	 ZB4 BD5	0.044		
		3 - spring return from left to centre	 ZB4 BD7	0.044		
		3 - spring return from right to centre	 ZB4 BD8	0.044		
		  ZB4 BJ3	Long handle, black	2 - stay put	 ZB4 BJ2	0.044
				2 - stay put with actuation of the centre contact	 ZB4 BJ2M ▲	0.044
2 - spring return from right to left	 ZB4 BJ4			0.044		
2 - spring return from right to left with actuation of centre contact	 ZB4 BJ4M ▲			0.044		
3 - stay put	 ZB4 BJ3			0.044		
3 - spring return to centre	 ZB4 BJ5			0.044		
3 - spring return from left to centre	 ZB4 BJ7			0.044		
3 - spring return from right to centre	 ZB4 BJ8			0.044		
  ZB4 BD29	Knurled knob, black	2 - stay put	 ZB4 BD29	0.046		
		2 - spring return from right to left	 ZB4 BD49	0.046		
		3 - stay put	 ZB4 BD39	0.046		
		3 - spring return to centre	 ZB4 BD59	0.046		
		3 - spring return from left to centre	 ZB4 BD79	0.046		
		3 - spring return from right to centre	 ZB4 BD89	0.046		

Heads with black metal bezel

















To order, add the suffix 7 to the references selected above.
Example: ZB4 BD2 becomes ZB4 BD27.

(1) Can only be used for actuation of end row (side) mounted contacts.

(2) For handles in other colours, please consult your Regional Sales Office.

▲ Available 3rd quarter 2001

Heads for selector switches (continued) (1)

Shape of head	Type of operator	Number and type of positions (2)	Reference (3)	Weight kg
	Key (n° 455) (4)	2 - stay put	 ZB4 BG2	0.069
			 ZB4 BG4	0.069
		2 - stay put with actuation of the centre contact	 ZB4 BG2M ▲	0.069
			 ZB4 BG4M ▲	0.069
		2 - spring return from right to left	 ZB4 BG6	0.069
		2 - spring return from right to left with actuation of centre contact	 ZB4 BG6M ▲	0.069
		3 - stay put	 ZB4 BG0	0.069
			 ZB4 BG3	0.069
			 ZB4 BG5	0.069
			 ZB4 BG9	0.069
			 ZB4 BG09	0.069
		3 - spring return from left to centre	 ZB4 BG1	0.069
		3 - spring return to centre	 ZB4 BG7	0.069
		3 - spring return from right to centre	 ZB4 BG8	0.069
			 ZB4 BG08	0.069

814204



ZB4 BG8

814205



ZB4 BD28

Heads for toggle switches (black lever)

Shape of head	Description	Type of position	Reference	Weight kg
	2-position	Stay put	ZB4 BD28	0.026
		Spring return	ZB4 BD48	0.026

Heads with black metal bezel

To order, add the suffix 7 to the references selected above.
Example: **ZB4 BG2** becomes **ZB4 BG27**.

(1) Can only be used for actuation of end row (side) mounted contacts.

(2) The symbol  indicates key withdrawal position(s).

(3) Other key numbers:

- key n° 421E: add suffix **12** to the reference.
- key n° 458A: add suffix **10** to the reference.
- key n° 520E: add suffix **14** to the reference.
- key n° 3131A: add suffix **20** to the reference.

Example:

For a switch head with key n° 421E, 2-position stay put with key withdrawal from the left-hand position, the reference becomes: **ZB4 BG212**.

(4) For specific keys with other numbers, please consult your Regional Sales Office.

▲ Available 3rd quarter 2001

References

To combine with heads for integral LED : see page 36006/5

Control and signalling units Ø 22

Harmony® style 4
Pilot lights, with metal bezel
Sub-assemblies, ZB4-B : bodies

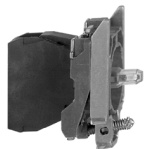

ZB4-BV●●

Complete bodies (fixing collar + light block with integral LED)

Light source	Supply voltage	Colour of light source	Reference	Weight
	V			kg

Screw clamp terminal connections

Integral LED Protected LED	≈ 12	White	<u>ZB4-BVJ1</u>	0.054
		Green	<u>ZB4-BVJ3</u>	0.054
		Red	<u>ZB4-BVJ4</u>	0.054
		Yellow	<u>ZB4-BVJ5</u>	0.054
		Blue	<u>ZB4-BVJ6</u>	0.054
		≈ 24 (1) (2)	White	<u>ZB4-BVB1</u>
Green	<u>ZB4-BVB3</u>		0.054	
Red	<u>ZB4-BVB4</u>		0.054	
Yellow	<u>ZB4-BVB5</u>		0.054	
Blue	<u>ZB4-BVB6</u>		0.054	
≈ 24...120	White		<u>ZB4-BVVG1</u>	0.054
	Green	<u>ZB4-BVVG3</u>	0.054	
	Red	<u>ZB4-BVVG4</u>	0.054	
	Yellow	<u>ZB4-BVVG5</u>	0.054	
	Blue	<u>ZB4-BVVG6</u>	0.054	
	≈ 48...120 (2)	White	<u>ZB4-BVG1</u>	0.054
Green		<u>ZB4-BVG3</u>	0.054	
Red		<u>ZB4-BVG4</u>	0.054	
Yellow		<u>ZB4-BVG5</u>	0.054	
Blue		<u>ZB4-BVG6</u>	0.054	
≈ 230...240 (2)		White	<u>ZB4-BVM1</u>	0.054
	Green	<u>ZB4-BVM3</u>	0.054	
	Red	<u>ZB4-BVM4</u>	0.054	
	Yellow	<u>ZB4-BVM5</u>	0.054	
	Blue	<u>ZB4-BVM6</u>	0.054	

(1) For 3 terminal "test" function, add the suffix **156** to the references selected above, example: **ZB4-BVB3156**, complete body with integral LED, with "test" function, colour green.

(2) Complete bodies with flashing light block.

Complete bodies with Faston connector terminals (6.35 or 2 x 2.8).

Please consult your Regional Sales Office.

References (continued)

To combine with heads for integral LED : see page 36006/5

Control and signalling units Ø 22

Harmony® style 4
Pilot lights, with metal bezel
Sub-assemblies, ZB4-B : bodies

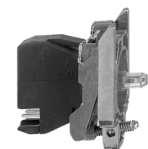

ZB4-BV004

Complete bodies (fixing collar + light block with integral LED)

Light source	Supply voltage	Colour of light source	Reference	Weight
	V			kg
Plug-in connector (1)				
Integral LED Protected LED	~ 24	White	ZB4-BVB14	0.053
		Green	ZB4-BVB34	0.053
		Red	ZB4-BVB44	0.053
		Yellow	ZB4-BVB54	0.053
		Blue	ZB4-BVB64	0.053
	~ 48...120	White	ZB4-BVG14	0.053
		Green	ZB4-BVG34	0.053
		Red	ZB4-BVG44	0.053
		Yellow	ZB4-BVG54	0.053
		Blue	ZB4-BVG64	0.053
	~ 230...240	White	ZB4-BVM14	0.053
		Green	ZB4-BVM34	0.053
		Red	ZB4-BVM44	0.053
		Yellow	ZB4-BVM54	0.053
		Blue	ZB4-BVM64	0.053

(1) Connecting cables and connector for plug-in connector light blocks : see page 36008/4.

Other versions

Complete bodies with flashing light block.
Complete bodies with Faston connector terminals (6.35 or 2 x 2.8).
Please consult your Regional Sales Office.

General :
pages 36022/2 to 36024/5

Characteristics :
pages 36001/2 to 36001/5

Dimensions :
pages 36020/2 to 36020/9

References (continued)

To combine with heads for BA 9s bulb : see page 36006/5

Control and signalling units Ø 22

Harmony® style 4
Pilot lights, with metal bezel
Sub-assemblies, ZB4-B : bodies

Complete bodies (fixing collar + light block for BA 9s incandescent bulb, neon or LED)

Description	Light source	Supply voltage	Colour of light source	Reference	Weight	
		V			kg	
Screw clamp terminal connections						
Direct supply	BA 9s bulb, 2.4 W max. Not included (1)	≤ 250	–	ZB4-BV6	0.052	
Direct supply "Test" function (3 terminals)	BA 9s bulb, 2.4 W max. Not included (1)	≤ 250	–	ZB4-BV156	0.062	
Via integral transformer 1.2 VA, 6 V secondary	BA 9s incandescent bulb included	~ 110...120 50/60 Hz	–	ZB4-BV3	0.130	
		~ 230 50 Hz	–	ZB4-BV4	0.130	
		~ 220...240 60 Hz	–			
		~ 400 50 Hz	–	ZB4-BV5	0.131	
		~ 440...480 60 Hz	–	ZB4-BV8	0.128	
	BA 9s base fitting LED included	~ 110...120 50/60 Hz	White		ZB4-BV3D1	0.134
			Green		ZB4-BV3D3	0.134
			Red		ZB4-BV3D4	0.134
			Yellow		ZB4-BV3D5	0.134
			Blue		ZB4-BV3D6	0.134
~ 230 50 Hz 220...240 60 Hz	White			ZB4-BV4D1	0.134	
	Green		ZB4-BV4D3	0.134		
	Red		ZB4-BV4D4	0.134		
	Yellow		ZB4-BV4D5	0.134		
	Blue		ZB4-BV4D6	0.134		
	~ 400 50/60 Hz	White		ZB4-BV5D1	0.134	
Green			ZB4-BV5D3	0.134		
Red			ZB4-BV5D4	0.134		
Yellow			ZB4-BV5D5	0.134		
			Blue	ZB4-BV5D6	0.134	

(1) Bulb to be ordered separately.

Other versions

Complete bodies with Faston connector terminals (6.35 or 2 x 2.8). Please consult your Regional Sales Office.

Control and signalling units Ø 22

Harmony® style 4
Pilot lights, with metal bezel
Sub-assemblies, ZB4-B : heads



ZB4-BV063



ZB4-BV04

Heads

Shape of head	For use with body comprising light source type	Colour of lens	Reference	Weight kg
With plain lens				
	Integral LED only Protected LED	White	ZB4-BV013	0.026
		Green	ZB4-BV033	0.026
		Red	ZB4-BV043	0.026
		Yellow	ZB4-BV053	0.026
		Blue	ZB4-BV063	0.026
	BA 9s only (incandescent, neon or LED)	White	ZB4-BV01	0.027
		Green	ZB4-BV03	0.027
		Red	ZB4-BV04	0.027
		Yellow	ZB4-BV05	0.027
		Blue	ZB4-BV06	0.027
Clear	ZB4-BV07	0.027		
With grooved lens (2)				
	Integral LED only Protected LED	White	ZB4-BV013S	0.026
		Green	ZB4-BV033S	0.026
		Red	ZB4-BV043S	0.026
		Yellow	ZB4-BV053S	0.026
		Blue	ZB4-BV063S	0.026
With plain lens, for insertion of legend (1)				
	Integral LED only Protected LED	White	ZB4-BV013E	0.026
		Green	ZB4-BV033E	0.026
		Red	ZB4-BV043E	0.026
		Yellow	ZB4-BV053E	0.026
		Blue	ZB4-BV063E	0.026
With grooved lens (2)				
	BA 9s only (for neon and LED only)	White	ZB4-BV01S	0.027
		Green	ZB4-BV03S	0.027
		Red	ZB4-BV04S	0.027
		Yellow	ZB4-BV05S	0.027
		Blue	ZB4-BV06S	0.027
		Clear	ZB4-BV07S	0.027

(1) For legend ordering information, see page 36008/12.

(2) For use in bright ambient light conditions (outdoors in sunlight, for example).

References

To combine with heads for integral LED : see pages 36007/7 to 36007/9

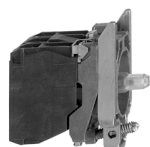

Control and signalling units Ø 22

Harmony® style 4
Illuminated pushbuttons and switches, with chromium plated metal bezel
Sub-assemblies, ZB4-B : bodies



ZB4-BW0003

Complete bodies (fixing collar + contact block(s) + light block with integral LED)

Light source	Supply voltage	Type of contact (1)		Colour of light source	Reference	Weight
						
V		N/O	N/C	kg		
Screw clamp terminal connections						
Integral LED Protected LED	~ 24	1	-	White	ZB4-BW0B11	0.064
				Green	ZB4-BW0B31	0.064
				Red	ZB4-BW0B41	0.064
				Yellow	ZB4-BW0B51	0.064
				Blue	ZB4-BW0B61	0.064
		-	1	White	ZB4-BW0B12	0.064
				Green	ZB4-BW0B32	0.064
				Red	ZB4-BW0B42	0.064
				Yellow	ZB4-BW0B52	0.064
				Blue	ZB4-BW0B62	0.064
		2	-	White	ZB4-BW0B13	0.074
				Green	ZB4-BW0B33	0.074
				Red	ZB4-BW0B43	0.074
				Yellow	ZB4-BW0B53	0.074
				Blue	ZB4-BW0B63	0.074
		1	1	White	ZB4-BW0B15	0.074
				Green	ZB4-BW0B35	0.074
				Red	ZB4-BW0B45	0.074
				Yellow	ZB4-BW0B55	0.074
				Blue	ZB4-BW0B65	0.074
~ 48...120	1	-	White	ZB4-BW0G11	0.064	
			Green	ZB4-BW0G31	0.064	
			Red	ZB4-BW0G41	0.064	
			Yellow	ZB4-BW0G51	0.064	
			Blue	ZB4-BW0G61	0.064	
	-	1	White	ZB4-BW0G12	0.064	
			Green	ZB4-BW0G32	0.064	
			Red	ZB4-BW0G42	0.064	
			Yellow	ZB4-BW0G52	0.064	
			Blue	ZB4-BW0G62	0.064	

(1) Can be fitted with additional contact blocks : see page 36008/2.

Other versions

Complete bodies with Faston connector terminals (6.35 or 2 x 2.8). Please consult your Regional Sales Office.

General : pages 36022/2 to 36024/5

Characteristics : pages 36001/2 to 36001/5

Dimensions : pages 36020/2 to 36020/9



References (continued)

To combine with heads for integral LED : see pages 36007/7 to 36007/9

Control and signalling units Ø 22

Harmony® style 4
Illuminated pushbuttons and switches, with chromium plated metal bezel
Sub-assemblies, ZB4-B : bodies

Complete bodies (fixing collar + contact block(s) + light block with integral LED) (continued)

Light source	Supply voltage	Type of contact (1)		Colour of light source	Reference	Weight
						
	V	N/O	N/C			kg

Screw clamp terminal connections (continued)

Integral LED 	~ 48...120	2	-	White	ZB4-BW0G13	0.074	
				Green	ZB4-BW0G33	0.074	
				Red	ZB4-BW0G43	0.074	
				Yellow	ZB4-BW0G53	0.074	
				Blue	ZB4-BW0G63	0.074	
	~ 230...240	1	1	White	ZB4-BW0G15	0.074	
				Green	ZB4-BW0G35	0.074	
				Red	ZB4-BW0G45	0.074	
				Yellow	ZB4-BW0G55	0.074	
				Blue	ZB4-BW0G65	0.074	
		-	1	-	White	ZB4-BW0M11	0.064
					Green	ZB4-BW0M31	0.064
					Red	ZB4-BW0M41	0.064
					Yellow	ZB4-BW0M51	0.064
					Blue	ZB4-BW0M61	0.064
-	1	1	White	ZB4-BW0M12	0.064		
			Green	ZB4-BW0M32	0.064		
			Red	ZB4-BW0M42	0.064		
			Yellow	ZB4-BW0M52	0.064		
			Blue	ZB4-BW0M62	0.064		
2	-	-	White	ZB4-BW0M13	0.074		
			Green	ZB4-BW0M33	0.074		
			Red	ZB4-BW0M43	0.074		
			Yellow	ZB4-BW0M53	0.074		
			Blue	ZB4-BW0M63	0.074		
1	1	1	White	ZB4-BW0M15	0.074		
			Green	ZB4-BW0M35	0.074		
			Red	ZB4-BW0M45	0.074		
			Yellow	ZB4-BW0M55	0.074		
			Blue	ZB4-BW0M65	0.074		

(1) Can be fitted with additional contact blocks : see page 36008/2.

Other versions

Complete bodies with Faston connector terminals (6.35 or 2 x 2.8).
Please consult your Regional Sales Office.

General :
pages 36022/2 to 36024/5

Characteristics :
pages 36001/2 to 36001/5

Dimensions :
pages 36020/2 to 36020/9

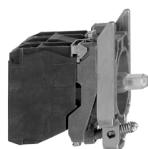

ZB4-BW0003

References (continued)

To combine with heads for integral LED : see pages 36007/7 to 36007/9

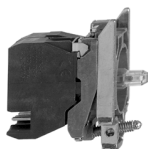

Control and signalling units Ø 22

Harmony® style 4
Illuminated pushbuttons and switches, with chromium plated metal bezel
Sub-assemblies, ZB4-B : bodies



ZB4-BW0014

Complete bodies (fixing collar + contact block(s) + light block with integral LED) (continued)

Light source	Supply voltage	Type of contact (1)		Colour of light source	Reference	Weight
						
	V	N/O	N/C			kg
Plug-in connector (2)						
Integral LED Protected LED	~ 24	1	-	White	ZB4-BW0B114	0.060
				Green	ZB4-BW0B314	0.060
				Red	ZB4-BW0B414	0.060
				Yellow	ZB4-BW0B514	0.060
				Blue	ZB4-BW0B614	0.060
		-	1	White	ZB4-BW0B124	0.060
				Green	ZB4-BW0B324	0.060
				Red	ZB4-BW0B424	0.060
				Yellow	ZB4-BW0B524	0.060
				Blue	ZB4-BW0B624	0.060
	2	-	White	ZB4-BW0B134	0.067	
			Green	ZB4-BW0B334	0.067	
			Red	ZB4-BW0B434	0.067	
			Yellow	ZB4-BW0B534	0.067	
			Blue	ZB4-BW0B634	0.067	
	1	1	White	ZB4-BW0B154	0.067	
			Green	ZB4-BW0B354	0.067	
			Red	ZB4-BW0B454	0.067	
			Yellow	ZB4-BW0B554	0.067	
			Blue	ZB4-BW0B654	0.067	
~ 48...120	1	-	White	ZB4-BW0G114	0.060	
			Green	ZB4-BW0G314	0.060	
			Red	ZB4-BW0G414	0.060	
			Yellow	ZB4-BW0G514	0.060	
			Blue	ZB4-BW0G614	0.060	
	-	1	White	ZB4-BW0G124	0.060	
			Green	ZB4-BW0G324	0.060	
			Red	ZB4-BW0G424	0.060	
			Yellow	ZB4-BW0G524	0.060	
			Blue	ZB4-BW0G624	0.060	

(1) Can be fitted with additional contact blocks : see page 36008/4.

(2) Connecting cables and connector for plug-in connector electrical blocks : see page 36008/4.

Other versions

Complete bodies with Faston connector terminals (6.35 or 2 x 2.8).
Please consult your Regional Sales Office.



References (continued)

To combine with heads for integral LED : see pages 36007/7 to 36007/9

Control and signalling units Ø 22

Harmony® style 4
Illuminated pushbuttons and switches, with chromium plated metal bezel
Sub-assemblies, ZB4-B : bodies

Complete bodies (fixing collar + contact block(s) + light block with integral LED) (continued)

Light source	Supply voltage	Type of contact (1)		Colour of light source	Reference	Weight
						
V		N/O	N/C	kg		
Plug-in connector (2)						
Integral LED Protected LED	~ 48...120	2	-	White	ZB4-BW0G134	0.067
				Green	ZB4-BW0G334	0.067
				Red	ZB4-BW0G434	0.067
				Yellow	ZB4-BW0G534	0.067
				Blue	ZB4-BW0G634	0.067
		1	1	White	ZB4-BW0G154	0.067
				Green	ZB4-BW0G354	0.067
				Red	ZB4-BW0G454	0.067
				Yellow	ZB4-BW0G554	0.067
				Blue	ZB4-BW0G654	0.067
	~ 230...240	1	-	White	ZB4-BW0M114	0.060
				Green	ZB4-BW0M314	0.060
				Red	ZB4-BW0M414	0.060
				Yellow	ZB4-BW0M514	0.060
				Blue	ZB4-BW0M614	0.060
		-	1	White	ZB4-BW0M124	0.060
				Green	ZB4-BW0M324	0.060
				Red	ZB4-BW0M424	0.060
				Yellow	ZB4-BW0M524	0.060
				Blue	ZB4-BW0M624	0.060
	2	-	White	ZB4-BW0M134	0.067	
			Green	ZB4-BW0M334	0.067	
			Red	ZB4-BW0M434	0.067	
			Yellow	ZB4-BW0M534	0.067	
			Blue	ZB4-BW0M634	0.067	
	1	1	White	ZB4-BW0M154	0.067	
			Green	ZB4-BW0M354	0.067	
			Red	ZB4-BW0M454	0.067	
			Yellow	ZB4-BW0M554	0.067	
			Blue	ZB4-BW0M654	0.067	

(1) Can be fitted with additional contact blocks : see page 36008/4.

(2) Connecting cables and connector for plug-in connector electrical blocks : see page 36008/4.

Other versions

Complete bodies with Faston connector terminals (6.35 or 2 x 2.8).
Please consult your Regional Sales Office.

General :
pages 36022/2 to 36024/5

Characteristics :
pages 36001/2 to 36001/5

Dimensions :
pages 36020/2 to 36020/9

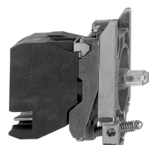

ZB4-BW034



References (continued)

To combine with heads for BA 9s bulbs : see pages 36007/7 to 36007/9

Control and signalling units Ø 22

Harmony® style 4
Illuminated pushbuttons and switches, with chromium plated metal bezel
Sub-assemblies, ZB4-B : bodies

Complete bodies (fixing collar + contact block(s) + light block for BA 9s incandescent bulb, neon or LED)

Supply	Light source	Supply voltage	Type of contact (1)		Colour of light source	Reference	Weight
							
		V	N/O	N/C			kg
Screw clamp terminal connections							
Direct supply	BA 9s 2.4 W max. bulb Not included (2)	≤ 250	1	–	–	<u>ZB4-BW061</u>	0.063
			–	1	–	<u>ZB4-BW062</u>	0.063
			2	–	–	<u>ZB4-BW063</u>	0.073
			1	1	–	<u>ZB4-BW065</u>	0.073
Via integral transformer secondary	BA 9s incandescent bulb included	~ 110...120 50/60 Hz	1	–	–	<u>ZB4-BW031</u>	0.141
			1	1	–	<u>ZB4-BW035</u>	0.151
			1	–	–	<u>ZB4-BW041</u>	0.141
			1	1	–	<u>ZB4-BW045</u>	0.151
			1	–	–	<u>ZB4-BW051</u>	0.141
			1	1	–	<u>ZB4-BW055</u>	0.151
	BA 9s base fitting LED included	~ 110...120 50/60 Hz	1	1	White	<u>ZB4-BW03D15</u>	0.151
					Green	<u>ZB4-BW03D35</u>	0.151
					Red	<u>ZB4-BW03D45</u>	0.151
					Yellow	<u>ZB4-BW03D55</u>	0.151
					Blue	<u>ZB4-BW03D65</u>	0.151
			1	1	White	<u>ZB4-BW04D15</u>	0.151
~ 230 50 Hz ~ 220...240 60 Hz	~ 230 50 Hz ~ 220...240 60 Hz	1	1	Green	<u>ZB4-BW04D35</u>	0.151	
				Red	<u>ZB4-BW04D45</u>	0.151	
				Yellow	<u>ZB4-BW04D55</u>	0.151	
				Blue	<u>ZB4-BW04D65</u>	0.151	
		1	1	White	<u>ZB4-BW05D15</u>	0.152	
				Green	<u>ZB4-BW05D35</u>	0.152	
~ 400 50/60 Hz	~ 400 50/60 Hz	1	1	Red	<u>ZB4-BW05D45</u>	0.152	
				Yellow	<u>ZB4-BW05D55</u>	0.152	
				Blue	<u>ZB4-BW05D65</u>	0.152	

(1) Can be fitted with additional contact blocks : see page 36008/2.

(2) Bulb to be ordered separately : see page 36008/14.

Other versions

Complete bodies with integral transformer incorporating Faston connector terminals (6.35 or 2 x 2.8).
Please consult your Regional Sales Office.









General :
pages 36022/2 to 36024/5

Characteristics :
pages 36001/2 to 36001/5

Dimensions :
pages 36020/2 to 36020/9

Harmony® style 4
Illuminated pushbuttons and switches, with chromium plated metal bezel
Sub-assemblies, ZB4-B : heads

Heads for spring return illuminated pushbuttons

Shape of head	Type of push	Colour	Reference	Weight kg
With plain lens				
Only for use with bodies comprising a light block with integral LED				
	Flush	White	ZB4-BW313	0.026
		Green	ZB4-BW333	0.026
		Red	ZB4-BW343	0.026
		Yellow	ZB4-BW353	0.026
		Blue	ZB4-BW363	0.026
	Flush with illuminated ring	White	ZB4-BW913	0.026
		Green	ZB4-BW933	0.026
		Red	ZB4-BW943	0.026
		Yellow	ZB4-BW953	0.026
		Blue	ZB4-BW963	0.026
	Flush with clear boot	White	ZB4-BW513	0.031
		Green	ZB4-BW533	0.031
		Red	ZB4-BW543	0.031
		Yellow	ZB4-BW553	0.031
		Blue	ZB4-BW563	0.031
	Flush for insertion of legend	White	ZB4-BA18	0.028
		Green	ZB4-BA38	0.028
		Red	ZB4-BA48	0.028
		Yellow	ZB4-BA58	0.028
		Blue	ZB4-BA68	0.028
	Projecting	White	ZB4-BW113	0.029
		Green	ZB4-BW133	0.029
		Red	ZB4-BW143	0.029
		Yellow	ZB4-BW153	0.029
		Blue	ZB4-BW163	0.029
With grooved lens (1)				
Only for use with bodies comprising a light block with integral LED				
	Flush	White	ZB4-BW313S	0.026
		Green	ZB4-BW333S	0.026
		Red	ZB4-BW343S	0.026
		Yellow	ZB4-BW353S	0.026
		Blue	ZB4-BW363S	0.026
With plain lens				
Only for use with bodies comprising a light block for a BA 9s bulb (incandescent, neon or LED)				
	Flush	White	ZB4-BW31	0.027
		Green	ZB4-BW33	0.027
		Red	ZB4-BW34	0.027
		Yellow	ZB4-BW35	0.027
		Blue	ZB4-BW36	0.027
		Clear	ZB4-BW37	0.027
			Projecting	White
Green	ZB4-BW13			0.028
Red	ZB4-BW14			0.028
Yellow	ZB4-BW15			0.028
Blue	ZB4-BW16			0.028
Clear	ZB4-BW17			0.028
With grooved lens (1)				
Only for use with bodies comprising a light block for a BA 9s bulb (incandescent, neon or LED)				
	Flush	White	ZB4-BW31S	0.027
		Green	ZB4-BW33S	0.027
		Red	ZB4-BW34S	0.027
		Yellow	ZB4-BW35S	0.027
		Blue	ZB4-BW36S	0.027
		Clear	ZB4-BW37S	0.027

(1) For use in bright ambient light conditions (outdoors in sunlight, for example).

Heads with black metal bezel

To order, add the suffix 7 to the references selected above.
Example: ZB4-BW313 becomes ZB4-BW3137.

Control and signalling units Ø 22

Harmony® style 4
Illuminated pushbuttons and switches, with chromium plated metal bezel
Sub-assemblies, ZB4-B : heads

Heads for illuminated "push-push to release" pushbuttons (1)

Shape of head	Type of push	Colour of lens	Reference	Weight kg
Only for use with bodies comprising a light block with integral LED				
	Flush	White	ZB4-BH013	0.026
		Green	ZB4-BH033	0.026
		Red	ZB4-BH043	0.026
		Yellow	ZB4-BH053	0.026
		Blue	ZB4-BH063	0.026



ZB4-BH033



ZB4-BH63

	Projecting	White	ZB4-BH13	0.026
		Green	ZB4-BH33	0.026
		Red	ZB4-BH43	0.026
		Yellow	ZB4-BH53	0.026
		Blue	ZB4-BH63	0.026

Heads with pilot light for double-headed spring return pushbuttons (IP 40) (2)

Shape of head	Description	Colour of pushes	Colour of pilot light	Reference	Weight kg
Only for use with bodies comprising a light block with integral LED					
(without function marking on push)					



ZB4-BW812743

	1 flush push 1 central pilot light 1 flush push	Black Red	Clear (3)	ZB4-BW812743	0.047
		Green Red	Clear (3)	ZB4-BW813743	0.047
		White Black	Clear (3)	ZB4-BW811723	0.047
	1 flush push 1 central pilot light 1 projecting push	Black Red	Clear (3)	ZB4-BW832743	0.046
		Green Red	Clear (3)	ZB4-BW833743	0.046
		White Black	Clear (3)	ZB4-BW831723	0.046

Only for use with bodies comprising a light block with integral LED
 (with function marking on push)

ZB4-BW823743

	1 flush push (marked "I") 1 central pilot light 1 flush push (marked "O")	Black Red	Clear (3)	ZB4-BW822743	0.047
		Green Red	Clear (3)	ZB4-BW823743	0.047
		White Black	Clear (3)	ZB4-BW821723	0.047
	1 flush push (marked "I") 1 central pilot light 1 projecting push (marked "O")	Black Red	Clear (3)	ZB4-BW842743	0.046
		Green Red	Clear (3)	ZB4-BW843743	0.046
		White Black	Clear (3)	ZB4-BW841723	0.046



ZB4-BW841723

Heads with black metal bezel

To order, add the suffix 7 to the references listed above.
Example : ZB4-BW812743 becomes ZB4-BW8127437.

- (1) Maximum of 1 row of 2 contact blocks on associated body/fixing collar sub-assembly.
(2) NEMA type 1. For IP 66 degree of protection (NEMA type 4X), fit clear sealing boot ZBW-008 : see page 36008/15.
(3) Colour of centrally positioned pilot light determined by the colour of the LED incorporated in the body sub-assembly.

Control and signalling units Ø 22

Harmony® style 4

Illuminated pushbuttons and switches, with chromium plated metal bezel

Sub-assemblies, ZB4-B : heads

Heads for spring return Ø40 mushroom head illuminated pushbuttons

Shape of head	Colour of push	Reference	Weight kg
---------------	----------------	-----------	-----------

Only for use with bodies comprising a light block with integral LED

Protected
LED

White	ZB4-BW413	0.051
Green	ZB4-BW433	0.051
Red	ZB4-BW443	0.051
Yellow	ZB4-BW453	0.051
Blue	ZB4-BW463	0.051



ZB4-BW413

Heads for latching Ø40 mushroom head illuminated pushbuttons

Shape of head	Type of push	Colour of push	Reference	Weight kg
---------------	--------------	----------------	-----------	-----------

Only for use with bodies comprising a light block with integral LED

Protected
LED

Push-pull	White	ZB4-BW613	0.051
	Green	ZB4-BW633	0.051
	Red	ZB4-BW643	0.051
	Yellow	ZB4-BW653	0.051
	Blue	ZB4-BW663	0.051

Heads for illuminated selector switches, standard handle (1)

Shape of head	Number and type of positions	Colour of handle	Reference	Weight kg
---------------	------------------------------	------------------	-----------	-----------

Only for use with bodies comprising a light block with integral LED

Protected
LED

2 - stay put		White	ZB4-BK1213	0.040
		Green	ZB4-BK1233	0.040
		Red	ZB4-BK1243	0.040
		Yellow	ZB4-BK1253	0.040
		Blue	ZB4-BK1263	0.040
2 - spring return from right to left		White	ZB4-BK1413	0.040
		Green	ZB4-BK1433	0.040
		Red	ZB4-BK1443	0.040
		Yellow	ZB4-BK1453	0.040
		Blue	ZB4-BK1463	0.040
3 - stay put		White	ZB4-BK1313	0.040
		Green	ZB4-BK1333	0.040
		Red	ZB4-BK1343	0.040
		Yellow	ZB4-BK1353	0.040
		Blue	ZB4-BK1363	0.040
3 - spring return to centre		White	ZB4-BK1513	0.040
		Green	ZB4-BK1533	0.040
		Red	ZB4-BK1543	0.040
		Yellow	ZB4-BK1553	0.040
		Blue	ZB4-BK1563	0.040
3 - spring return from right to centre		White	ZB4-BK1813	0.040
		Green	ZB4-BK1833	0.040
		Red	ZB4-BK1843	0.040
		Yellow	ZB4-BK1853	0.040
		Blue	ZB4-BK1863	0.040
3 - spring return from left to centre		White	ZB4-BK1713	0.040
		Green	ZB4-BK1733	0.040
		Red	ZB4-BK1743	0.040
		Yellow	ZB4-BK1753	0.040
		Blue	ZB4-BK1763	0.040



ZB4-BK1343

Heads with black metal bezel

To order, add the suffix 7 to the references selected above.

Example : ZB4-BK1213 becomes ZB4-BK12137.

(1) NEMA type 13.

Control and signalling units Ø 22

Harmony® style 4

Pushbuttons, switches and pilot lights with chromium plated metal bezel

Separate components and accessories: electrical blocks

814265



ZBE 101

814266



ZBE 102

814267



ZBE 203

814268



ZBE 204

814264



ZB4 BZ009

814262

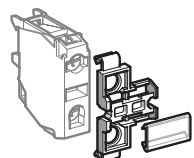

ZBZ 001

963527



XBY 2U

Contact blocks with screw clamp terminal connections (1)

Description	Type of contact		Sold in lots of	Unit reference	Weight kg
	N/O	N/C			
Standard single contact blocks	1	–	5	ZBE 101	0.011
	–	1	5	ZBE 102	0.011
Standard double contact blocks	2	–	5	ZBE 203	0.020
	–	2	5	ZBE 204	0.020
	1	1	5	ZBE 205	0.020
Special contact blocks for low power switching with gold flashed contacts	1	–	5	ZBE 1016	0.012
	–	1	5	ZBE 1026	0.012
Special contact blocks for low power switching with gold flashed contacts and dust protection (2)	1	–	5	ZBE 1016P	0.012
	–	1	5	ZBE 1026P	0.012

Body/fixing collar

For use on	Sold in lots of	Unit reference	Weight kg
Electrical block (contact or light)	10	ZB4 BZ009	0.038

Clip-on legend holders for electrical blocks with screw clamp terminal connections

Application	Sold in lots of	Unit reference	Weight kg
Identification of an XB4 B control or signalling unit	10	ZBZ 001	0.001

Sheet of 50 blank legends

For use on	Sold in lots of	Unit reference	Weight kg
Legend holder ZBZ 001	10	ZBY 001	0.023

"SIS Label" labelling software (for legends ZBY 001)

Application	Reference	Weight kg
Legend design for English, French, German, Italian, Spanish	XBY 2U	0.100

(1) The contact blocks enable variable composition of body sub-assemblies. Maximum number of rows possible: 3.
Either 3 rows of 3 single contacts or 1 row of 3 double contacts + 1 row of 3 single contacts (double contact blocks occupy 2 rows).

(2) It is not possible to fit an additional contact block on the back of these blocks.

Other versions Contact blocks with Faston connector terminals (6.35 or 2 x 2.8). Please consult your Regional Sales Office.

Light blocks with screw clamp terminals

Description	Supply voltage V	Colour of light source	Sold in lots of	Unit reference	Weight kg
Integral LED (to combine with heads for integral LED)	≈ 12	White	5	ZBV J1 (1)	0.017
		Green	5	ZBV J3 (1)	0.017
		Red	5	ZBV J4 (1)	0.017
		Yellow	5	ZBV J5 (1)	0.017
		Blue	5	ZBV J6 (1)	0.017
		≈ 24	White	5	ZBV B1 (1)
Green	5		ZBV B3 (1)	0.017	
Red	5		ZBV B4 (1)	0.017	
Yellow	5		ZBV B5 (1)	0.017	
Blue	5		ZBV B6 (1)	0.017	
≈ 24...120	White		5	ZBV BG1	0.017
	Green	5	ZBV BG3	0.017	
	Red	5	ZBV BG4	0.017	
	Yellow	5	ZBV BG5	0.017	
	Blue	5	ZBV BG6	0.017	
	≈ 48...120	White	5	ZBV G1 (1)	0.017
Green		5	ZBV G3 (1)	0.017	
Red		5	ZBV G4 (1)	0.017	
Yellow		5	ZBV G5 (1)	0.017	
Blue		5	ZBV G6 (1)	0.017	
≈ 230...240		White	5	ZBV M1 (1)	0.017
	Green	5	ZBV M3 (1)	0.017	
	Red	5	ZBV M4 (1)	0.017	
	Yellow	5	ZBV M5 (1)	0.017	
	Blue	5	ZBV M6 (1)	0.017	
	Direct supply for BA 9s 2.4 W max. bulb Not included (2)	≤ 250	–	5	ZBV 6

LED suppressors

For use with	Supply voltage V	Reference	Weight kg
Light blocks with integral LED fitted with screw clamp terminal connections	≈ 120	ZBV VG	0.010
	≈ 230	ZBV VM	0.010

Body/fixing collar

For use with	Sold in lots of	Unit reference	Weight kg
Electrical block (contact or light)	10	ZB4 BZ009	0.038

Clip-on legend holders for electrical blocks with screw clamp terminal connections

Application	Sold in lots of	Unit reference	Weight kg
Identification of an XB4 B control or signalling unit	10	ZBZ 001	0.001

Sheet of 50 blank legends

For use with	Sold in lots of	Unit reference	Weight kg
Legend holder ZBZ 001	10	ZBY 001	0.023

"SIS Label" labelling software (for legends ZBY 001)

Application	Reference	Weight kg
Legend design for English, French, German, Italian, Spanish	XYB 2U	0.100

(1) To order a "high luminosity" version, add the suffix **S** to the reference (example: **ZBV B5S** for a yellow, 24 V, high luminosity light block).

(2) Bulb to be ordered separately, see page 36008/14.

Other versions Light blocks with Faston connector terminals (6.35 or 2 x 2.8). Please consult your Regional Sales Office.

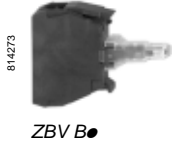

814273

ZBV B●

Protected LED



814274

ZBZ V●



814272

ZB4 BZ009

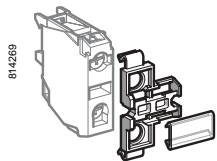

814269

ZBZ 001

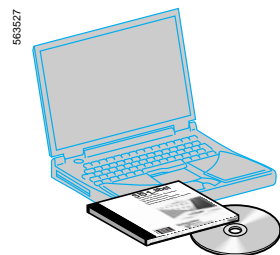

563527

XYB 2U

Control and signalling units Ø 22



Harmony® style 4

Pushbuttons, switches and pilot lights with chromium plated metal bezel

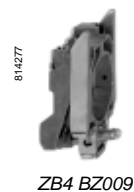
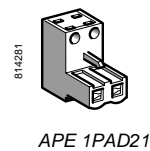
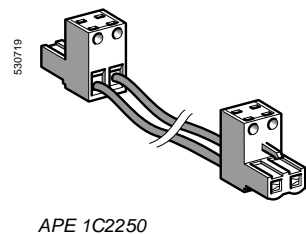
Separate components and accessories: electrical blocks



Contact blocks for plug-in connector

Description	Type of contact	Sold in lots of	Unit reference	Weight
	 			kg
Standard contact blocks	1 N/O, 0 N/C	5	ZBE 1014	0.009
	0 N/O, 1 N/C	5	ZBE 1024	0.009

Light blocks for plug-in connector

Description	Supply voltage V	Colour of light source	Sold in lots of	Unit reference	Weight
Integral LED (to combine with heads for integral LED)	≈ 24	White	5	ZBV B14	0,016
		Green	5	ZBV B34	0,016
		Red	5	ZBV B44	0,016
		Yellow	5	ZBV B54	0,016
		Blue	5	ZBV B64	0,016
	~ 48...120	White	5	ZBV G14	0,016
		Green	5	ZBV G34	0,016
		Red	5	ZBV G44	0,016
		Yellow	5	ZBV G54	0,016
		Blue	5	ZBV G64	0,016
~ 230...240	White	5	ZBV M14	0,016	
	Green	5	ZBV M34	0,016	
	Red	5	ZBV M44	0,016	
	Yellow	5	ZBV M54	0,016	
	Blue	5	ZBV M64	0,016	

Connecting cables and connector

Description	Number of connectors	Wire c.s.a. mm ²	Length mm	Sold in lots of	Unit reference	Weight
Cables with connectors 2-pin, 5.08 mm pitch	1	0.75	500	8	APE 1C2150	0,120
	2	0.75	500	8	APE 1C2250	0,180
Self-stripping connector 2-pin, 5.08 mm pitch	–	0.75	–	16	APE 1PAD21	0,080
Spring terminal connector 2-pin, 5.08 mm pitch	–	0.2 to 2.5	–	10	APE 1PRE21	0,003

Body/fixing collar

For use with	Sold in lots of	Unit reference	Weight
Electrical block (contact or light)	10	ZB4 BZ009	0,038

Contact blocks for printed circuit board connection (1)

Description	Type of contact		Sold in lots of	Unit reference	Weight kg
	N/O	N/C			
Standard contact blocks	1	–	10	ZBE 701	0.002
	–	1	10	ZBE 702	0.002
Special contact blocks for low power switching (with gold flashed contacts and dust protection)	1	–	10	ZBE 7016	0.003
	–	1	10	ZBE 7026	0.003

814287



ZBE 701

814288

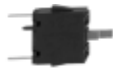

ZBE 702

814289



ZBV B07

Light blocks for printed circuit board connection (1)

Description	Supply voltage V	Colour of LED	Sold in lots of	Unit reference	Weight kg
Protected LED		Green	5	ZBV B37	0.004
		Red	5	ZBV B47	0.004
		Yellow	5	ZBV B57	0.004
		Blue	5	ZBV B67	0.004

814277



ZB4 BZ009

540159



ZBZ 010

Adaptor (socket) for printed circuit board connection

For use with	Thickness of printed circuit board mm	Sold in lots of	Unit reference	Weight kg
Electrical block (contact or light)	1.6 ± 0.2	10	ZBZ 010	0.008
	2.2 ± 0.2	10	ZBZ 011	0.008
	3.2 ± 0.2	10	ZBZ 012	0.008

Body/fixing collar

For use with	Sold in lots of	Unit reference	Weight kg
Electrical block (contact or light)	10	ZB4 BZ009	0.038

Accessories specifically for printed circuit board mounting (1)

Description	Application	Sold in lots of	Unit reference	Weight kg
Fixing collar/pillar	Printed circuit board support	10	ZB4 BZ079	0.003
Fixing screw for printed circuit board	Fixing collar/pillar ZB4 BZ079	10	ZBZ 006	0.011

814286



ZB4 BZ079 + ZB4 BZ009

(1) For details of support drilling and of printed circuit board: see page 36020/9.
Must be used in conjunction with adaptor (socket) ZBZ 010.

Control and signalling units Ø 22

Harmony® style 4

Pushbuttons, switches and pilot lights with chromium plated metal bezel

Separate components and accessories: for heads



814282

ZBA ●



814283

ZBL ●



814284

ZBA ●33

Pushbutton caps - unmarked

For use with	Type of push	Colour	Sold in lots of	Unit reference	Weight kg
ZB4 BA0 circular pushbutton heads supplied without cap	Flush	White	10	ZBA 1	0.001
		Black	10	ZBA 2	0.001
		Green	10	ZBA 3	0.001
		Red	10	ZBA 4	0.001
		Yellow	10	ZBA 5	0.001
		Blue	10	ZBA 6	0.001
		6 colours (1)	1	ZBA 9	0.006
	Projecting	White	10	ZBL 1	0.001
		Black	10	ZBL 2	0.001
		Green	10	ZBL 3	0.001
		Red	10	ZBL 4	0.001
		Yellow	10	ZBL 5	0.001
		Blue	10	ZBL 6	0.001
		6 colours (1)	1	ZBL 9	0.006

Pushbutton caps - marked (sold in lots of 10)

For use with	Type of push	Marking		Colour of cap	Unit reference	Weight kg
		Text	Colour			
ZB4 BA0 circular pushbutton heads supplied without cap	Flush	I (2)	White	Green	ZBA 331	0,001
			Black	White	ZBA 131	0.001
		II	White	Green	ZBA 336	0.001
			Black	White	ZBA 136	0.001
		III	White	Green	ZBA 337	0.001
			Black	White	ZBA 137	0.001
		IV	White	Green	ZBA 338	0.001
			Black	White	ZBA 138	0.001
		START (2)	White	Green	ZBA 333	0.001
			Black	White	ZBA 133	0.001
		ON	White	Green	ZBA 341	0.001
			Black	White	ZBA 141	0.001
		MARCHE	White	Green	ZBA 342	0.001
			Black	White	ZBA 142	0.001
		UP (2)	Black	White	ZBA 343	0.001
		DOWN (2)	White	Black	ZBA 344	0.001
		Ⓣ (2)	White	Black	ZBA 245	0.001
			Black	White	ZBA 145	0.001
		↑ (3)	White	Black	ZBA 335	0.001
			Black	White	ZBA 334	0.001
		O (2)	White	Red	ZBA 432	0.001
			Black	Black	ZBA 232	0.001
		ARRET	White	Red	ZBA 433	0.001
			Black	Black	ZBA 233	0.001
		STOP (2)	White	Red	ZBA 434	0.001
			Black	Black	ZBA 234	0.001
		OFF	White	Red	ZBA 435	0.001
			Black	Black	ZBA 235	0.001
		◇	White	Green	ZBA 346	0.001
		R (2)	White	Blue	ZBA 639	0.001
		+	White	Black	ZBA 2934	0.001
		-	White	Black	ZBA 2935	0.001

(1) Set of 6 different coloured caps: white, black, green, red, yellow, blue.

(2) Double injection moulded marking

(3) Can be clipped-in at 90° steps, through 360°.

Control and signalling units Ø 22

Harmony® style 4

Pushbuttons, switches and pilot lights with chromium plated metal bezel

Separate components and accessories: for heads

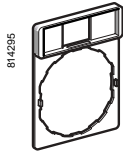

ZBZ 32

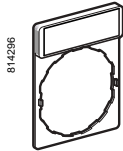

ZBY 101

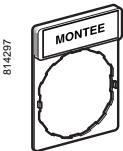

ZBY 2107

Standard (30 x 40 mm) legend holders for 8 x 27 mm legends⁽¹⁾

Description	Legend		Sold in lots of	Unit reference	Weight kg
	Colour	Marking			
Without legend	–	–	10	ZBZ 32	0.001
With blank legend (for engraving)	Black or red background	–	10	ZBY 2101	0.002
	White or yellow background	–	10	ZBY 4101	0.002
With 8 x 27 mm legend (with International marking)	Black or red background	O (black background)	1	ZBY 2146	0.002
		O (red background)	1	ZBY 2931	0.002
		I	1	ZBY 2147	0.002
		II	1	ZBY 2148	0.002
		O-I	1	ZBY 2178	0.002
		I-II	1	ZBY 2179	0.002
		I-O-II	1	ZBY 2186	0.002
		AUTO	1	ZBY 2115	0.002
		STOP	1	ZBY 2304	0.002
		ARRET (red background)	1	ZBY 2104	0.002
		ARRET (black background)	1	ZBY 0104	0.002
		ARRET GENERAL	1	ZBY 2129	0.002
		ARRET REARMEMENT	1	ZBY 2133	0.002
		ARRET D'URGENCE	1	ZBY 2130	0.002
		ARRET-MARCHE	1	ZBY 2166	0.002
ARRIERE	1	ZBY 2106	0.002		
AUTO CYCLE-CYCLE	1	ZBY 2198	0.002		
AUTO CYCLE-MAIN	1	ZBY 2199	0.002		
AUTO-MAIN	1	ZBY 2164	0.002		
AUTO-O-MAIN	1	ZBY 2185	0.002		
AVANT	1	ZBY 2105	0.002		
AVANT-O-ARRIERE	1	ZBY 2184	0.002		
C-P-C-NORMAL	1	ZBY 2165	0.002		
CYCLE-MAIN	1	ZBY 2197	0.002		
DECLENCHEMENT	1	ZBY 2132	0.002		
DEFAUT (black background)	1	ZBY 2134	0.002		
DEFAUT (red background)	1	ZBY 2135	0.002		
DEPART CYCLE	1	ZBY 2195	0.002		
DESCENTE	1	ZBY 2108	0.002		
DROITE	1	ZBY 2109	0.002		
ENCLENCHEMENT	1	ZBY 2131	0.002		
EN SERVICE	1	ZBY 2111	0.002		
FERMETURE	1	ZBY 2114	0.002		
GAUCHE	1	ZBY 2110	0.002		
HORS SERVICE	1	ZBY 2112	0.002		
HORS-EN	1	ZBY 2167	0.002		
LENT	1	ZBY 2127	0.002		
MAIN	1	ZBY 2116	0.002		
MARCHE	1	ZBY 2103	0.002		
MONTEE	1	ZBY 2107	0.002		
OUVERTURE	1	ZBY 2113	0.002		
PHASE / PHASE	1	ZBY 2196	0.002		
REARMEMENT (red bk.grnd)	1	ZBY 2123	0.002		
REARMEMENT (black bk.grnd)	1	ZBY 0123	0.002		
SOUS TENSION	1	ZBY 2126	0.002		
VITE	1	ZBY 2128	0.002		

(1) For legends, see pages 36008/9 to 36008/11.

(2) "Start" functions: white letters on black background. "Stop" functions: white letters on red background (unless otherwise specified above).

Control and signalling units Ø 22

Harmony® style 4

Pushbuttons, switches and pilot lights with chromium plated metal bezel

Separate components and accessories: for heads

Standard (30 x 40 mm) legend holders for 8 x 27 mm legends (continued)

Description	Legend		Reference	Weight kg		
	Colour	Marking				
With legend (with English language marking)	Black or red background (1)	AUTO-HAND	ZBY 2364	0.002		
		AUTO-O-HAND	ZBY 2385	0.002		
		CLOSE	ZBY 2314	0.002		
		DOWN	ZBY 2308	0.002		
		EMERGENCY STOP	ZBY 2330	0.002		
		FAST	ZBY 2328	0.002		
		FORWARD	ZBY 2305	0.002		
		HAND	ZBY 2316	0.002		
		HAND-OFF-AUTO	ZBY 2387	0.002		
		INCH	ZBY 2321	0.002		
		LEFT	ZBY 2310	0.002		
		OFF	ZBY 2312	0.002		
		OFF-ON	ZBY 2367	0.002		
		ON	ZBY 2311	0.002		
		OPEN	ZBY 2313	0.002		
		POWER ON	ZBY 2326	0.002		
		RESET (red background)	ZBY 2323	0.002		
		RESET (black background)	ZBY 2322	0.002		
		REVERSE	ZBY 2306	0.002		
		RIGHT	ZBY 2309	0.002		
		RUN	ZBY 2334	0.002		
		SLOW	ZBY 2327	0.002		
		START	ZBY 2303	0.002		
		STOP-START	ZBY 2366	0.002		
		UP	ZBY 2307	0.002		
		With legend (with German language marking)	Black or red background (1)	AB	ZBY 2208	0.002
				AUF	ZBY 2207	0.002
AUS	ZBY 2204			0.002		
AUS-EIN	ZBY 2266			0.002		
AUS-IN BETRIEB	ZBY 2267			0.002		
AUS-RUCKSTELLUNG	ZBY 2233			0.002		
AUSSCHALTEN	ZBY 2232			0.002		
AUTO-HAND	ZBY 2364			0.002		
AUTO-O-HAND	ZBY 2385			0.002		
AUTOZYKL-HAND	ZBY 2299			0.002		
AUTOZYKL- 1 ZYKL	ZBY 2298			0.002		
C-P-C-NORMAL	ZBY 2265			0.002		
EIN	ZBY 2203			0.002		
EINSCHALTEN	ZBY 2231			0.002		
HAND	ZBY 2316			0.002		
LANGSAM	ZBY 2227			0.002		
LINKS	ZBY 2210			0.002		
NOT-AUS (red background)	ZBY 2230			0.002		
NOT-AUS (yellow bk.grnd)	ZBY 22420001			0.002		
NOT-HALT	ZBY 2229			0.002		
ÖFFNEN	ZBY 2213			0.002		
RECHTS	ZBY 2209			0.002		
RUCKSTELLUNG	ZBY 2223			0.002		
SCHLIESSEN	ZBY 2214			0.002		
SCHNELL	ZBY 2228			0.002		
SPANNUNG EIN	ZBY 2226			0.002		
STEUERUNG AUS	ZBY 2212			0.002		
STEUERUNG EIN	ZBY 2211			0.002		
STORUNG (black bk.grnd)	ZBY 2234			0.002		
STORUNG (red background)	ZBY 2235			0.002		
VOR	ZBY 2205			0.002		
VOR-O-ZURUCK	ZBY 2284			0.002		
ZURUCK	ZBY 2206			0.002		
ZYKLUS-HAND	ZBY 2297	0.002				
ZYKLUSSTART	ZBY 2295	0.002				

(1) "Start" functions: white letters on black background. "Stop" functions: white letters on red background (unless otherwise specified above).

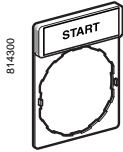

ZBY 2303

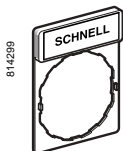

ZBY 2228

Control and signalling units Ø 22

Harmony® style 4

Pushbuttons, switches and pilot lights with chromium plated metal bezel

Separate components and accessories: for heads

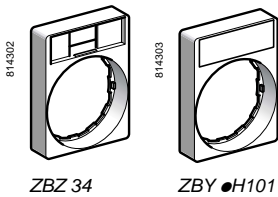

30 x 40 mm legend holders (flush mounting with bezel) for 8 x 27 mm legends

Description	Colour	Sold in lots of	Unit reference	Weight
Without legend	–	10	ZBZ 34	0.003 kg
With blank legend	Black or red background	10	ZBY 2H101	0.004
	White or yellow background	10	ZBY 4H101	0.004

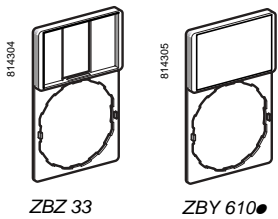

Standard (30 x 50 mm) legend holders for 18 x 27 mm legends

Description	Colour	Sold in lots of	Unit reference	Weight
Without legend	–	10	ZBZ 33	0.001 kg
With blank legend	Black or red background	10	ZBY 6101	0.002
	White or yellow background	10	ZBY 6102	0.002

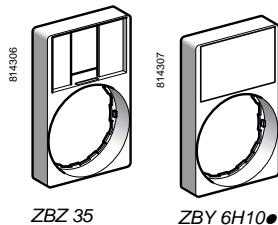

30 x 50 mm legend holders (flush mounting with bezel) for 18 x 27 mm legends

Description	Colour	Sold in lots of	Unit reference	Weight
Without legend	–	10	ZBZ 35	0.003 kg
With blank legend	Black or red background	10	ZBY 6H101	0.004
	White or yellow background	10	ZBY 6H102	0.004

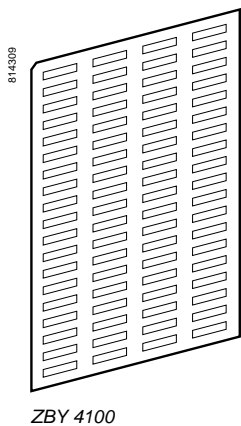

Legends for engraving

Description	For use with	Colour	Sold in lots of	Unit reference	Weight
8 x 27 mm	30 x 40 mm legend holder	Black or red background	10	ZBY 0101	0.001 kg
		White or yellow background	10	ZBY 0102	0.001
18 x 27 mm	30 x 50 mm legend holder	Black or red background	10	ZBY 5101	0.001
		White or yellow background	10	ZBY 5102	0.001

Sheets of peel-off legends (with backing board and protective transparent cover)

Description	For use with	Sold in lots of	Unit reference	Weight
Sheet of 76 legends 8 x 27 mm	30 x 40 mm legend holders ZBZ 32 and ZBZ 34	10	ZBY 4100	0.043 kg
Sheet of 40 legends 18 x 27 mm	30 x 50 mm legend holders ZBZ 33 and ZBZ 35	10	ZBY 5100	0.044

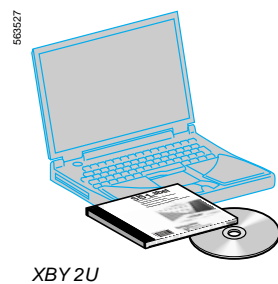

"SIS Label" labelling software

Application	Reference	Weight
Legend design for English, French, German, Italian, Spanish	XBY 2U	0.100 kg

Control and signalling units Ø 22

Harmony® style 4

Pushbuttons, switches and pilot lights with chromium plated metal bezel

Separate components and accessories: for heads

814310



ZBY 02178

8 x 27 mm marked legends (for 30 x 40 mm legend holders ZBZ 32 and ZBZ 34)

Colour	Marking	Reference	Weight kg			
Black or red background (1)	International	O (black background)	ZBY 02146	0.001		
		O (red background)	ZBY 02931	0.001		
		I	ZBY 02147	0.001		
		II	ZBY 02148	0.001		
		O-I	ZBY 02178	0.001		
		I-II	ZBY 02179	0.001		
		I-O-II	ZBY 02186	0.001		
		AUTO	ZBY 02115	0.001		
		STOP	ZBY 02304	0.001		
		French	ARRET (red background)	ZBY 02104	0.001	
				ARRET (black background)	ZBY 00104	0.001
				ARRET GENERAL	ZBY 02129	0.001
				ARRET REARMEMENT	ZBY 02133	0.001
ARRET D'URGENCE	ZBY 02130			0.001		
ARRET-MARCHE	ZBY 02166			0.001		
ARRIERE	ZBY 02106			0.001		
AUTO CYCLE-CYCLE	ZBY 02198			0.001		
AUTO CYCLE-MAIN	ZBY 02199			0.001		
AUTO-MAIN	ZBY 02164			0.001		
AUTO-O-MAIN	ZBY 02185			0.001		
AVANT	ZBY 02105			0.001		
AVANT-O-ARRIERE	ZBY 02184			0.001		
C-P-C-NORMAL	ZBY 02165			0.001		
CYCLE-MAIN	ZBY 02197			0.001		
DECLenchement	ZBY 02132			0.001		
DEFAUT (black background)	ZBY 02134			0.001		
DEFAUT (red background)	ZBY 02135			0.001		
DEPART CYCLE	ZBY 02195			0.001		
DESCENTE	ZBY 02108			0.001		
DROITE	ZBY 02109			0.001		
ENCLenchement	ZBY 02131			0.001		
EN SERVICE	ZBY 02111			0.001		
FERMETURE	ZBY 02114			0.001		
GAUCHE	ZBY 02110			0.001		
HORS SERVICE	ZBY 02112			0.001		
HORS-EN	ZBY 02167			0.001		
LENT	ZBY 02127			0.001		
MAIN	ZBY 02116			0.001		
MARCHE	ZBY 02103			0.001		
MONTEE	ZBY 02107			0.001		
Ouverture	ZBY 02113			0.001		
PHASE / PHASE	ZBY 02196			0.001		
REARMEMENT (red background)	ZBY 02123	0.001				
REARMEMENT (black background)	ZBY 00123	0.001				
SOUS TENSION	ZBY 02126	0.001				
VITE	ZBY 02128	0.001				

814311



ZBY 00104

(1) "Start" functions: white letters on black background. "Stop" functions: white letters on red background (unless otherwise specified above).

8 x 27 mm marked legends (for 30 x 40 mm legend holders ZBZ 32 and ZBZ 34) (continued)

Colour	Marking	Reference	Weight kg			
Black or red background (1)	English	AUTO-HAND	ZBY 02364	0.001		
		AUTO-O-HAND	ZBY 02385	0.001		
		CLOSE	ZBY 02314	0.001		
		DOWN	ZBY 02308	0.001		
		EMERGENCY STOP	ZBY 02330	0.001		
		FAST	ZBY 02328	0.001		
		FORWARD	ZBY 02305	0.001		
		HAND	ZBY 02316	0.001		
		HAND-OFF-AUTO	ZBY 02387	0.001		
		INCH	ZBY 02321	0.001		
		LEFT	ZBY 02310	0.001		
		OFF	ZBY 02312	0.001		
		OFF-ON	ZBY 02367	0.001		
		ON	ZBY 02311	0.001		
		OPEN	ZBY 02313	0.001		
		POWER ON	ZBY 02326	0.001		
		RESET (red background)	ZBY 02323	0.001		
		RESET (black background)	ZBY 02322	0.001		
		REVERSE	ZBY 02306	0.001		
		RIGHT	ZBY 02309	0.001		
		RUN	ZBY 02334	0.001		
		SLOW	ZBY 02327	0.001		
		START	ZBY 02303	0.001		
		STOP-START	ZBY 02366	0.001		
		UP	ZBY 02307	0.001		
			German	AB	ZBY 02208	0.001
				AUF	ZBY 02207	0.001
				AUS	ZBY 02204	0.001
				AUS-EIN	ZBY 02266	0.001
				AUS-IN BETRIEB	ZBY 02267	0.001
				AUS-RUCKSTELLUNG	ZBY 02233	0.001
				AUSSCHALTEN	ZBY 02232	0.001
				AUTO-HAND	ZBY 02364	0.001
AUTO-O-HAND	ZBY 02385			0.001		
AUTOZYKL-HAND	ZBY 02299			0.001		
AUTOZYKL- 1 ZYKL	ZBY 02298			0.001		
C-P-C-NORMAL	ZBY 02265			0.001		
EIN	ZBY 02203			0.001		
EINSCHALTEN	ZBY 02231			0.001		
HAND	ZBY 02316			0.001		
LANGSAM	ZBY 02227			0.001		
LINKS	ZBY 02210			0.001		
NOT-AUS (red background)	ZBY 02230			0.001		
NOT-AUS (yellow background)	ZBY 022420001			0.001		
NOT-HALT	ZBY 02229			0.001		
ÖFFNEN	ZBY 02213			0.001		
RECHTS	ZBY 02209			0.001		
RUCKSTELLUNG	ZBY 02223			0.001		
SCHLIESSEN	ZBY 02214			0.001		
SCHNELL	ZBY 02228			0.001		
SPANNUNG EIN	ZBY 02226			0.001		
STEUERUNG AUS	ZBY 02212			0.001		
STEUERUNG EIN	ZBY 02211			0.001		
STORUNG (black background)	ZBY 02234			0.001		
STORUNG (red background)	ZBY 02235			0.001		
VOR	ZBY 02205			0.001		
VOR-O-ZURUCK	ZBY 02284			0.001		
ZURUCK	ZBY 02206			0.001		
ZYKLUS-HAND	ZBY 02297			0.001		
ZYKLUSSTART	ZBY 02295			0.001		

(1) "Start" functions: white letters on black background. "Stop" functions: white letters on red background (unless otherwise specified above).

Control and signalling units Ø 22

Harmony® style 4

Pushbuttons, switches and pilot lights with chromium plated metal bezel

Separate components and accessories: for heads

814316

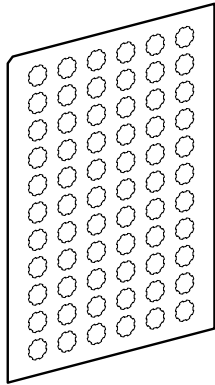

ZBY 1101

Legends for pushbuttons, switches and pilot lights XB4 B

Description	Marking		Sold in lots of	Unit reference	Weight kg	
Sheets of 66 circular peel-off transparent self-adhesive legends	Without		10	ZBY 1101	0.017	
Strips of 66 circular peel-off transparent self-adhesive legends	International	O	10	ZBY 1146	0.017	
		I	10	ZBY 1147	0.017	
		II	10	ZBY 1148	0.017	
		III	10	ZBY 1149	0.017	
		STOP	10	ZBY 1304	0.017	
		†	10	ZBY 1912	0.017	
	French	ARRET	10	ZBY 1104	0.017	
		ARRIERE	10	ZBY 1106	0.017	
		AUTO	10	ZBY 1115	0.017	
		AVANT	10	ZBY 1105	0.017	
		DESCENTE	10	ZBY 1108	0.017	
		MAIN	10	ZBY 1116	0.017	
		MARCHE	10	ZBY 1103	0.017	
		MONTEE	10	ZBY 1107	0.017	
		English	HAND	10	ZBY 1316	0.017
			OFF	10	ZBY 1312	0.017
			ON	10	ZBY 1311	0.017
			START	10	ZBY 1303	0.017
	German	AB	10	ZBY 1208	0.017	
		AUF	10	ZBY 1207	0.017	
AUS		10	ZBY 1204	0.017		
EIN		10	ZBY 1203	0.017		
ZU		10	ZBY 1214	0.017		

563527



XBY 2U

“SIS Label” labelling software

Application	Reference	Weight kg
Legend design for English, French, German, Italian, Spanish	XBY 2U	0.100

Circular legends for Emergency Stop mushroom head pushbuttons (yellow)

Diameter mm	Marking on yellow background	Reference	Weight kg
60	Without	ZBY 9101	0.004
	ARRET D'URGENCE	ZBY 9130	0.004
	EMERGENCY STOP	ZBY 9330	0.004
	NOT-AUS	ZBY 9230	0.004
90	Without	ZBY 8101	0.008
	ARRET D'URGENCE	ZBY 8130	0.008
	EMERGENCY STOP	ZBY 8330	0.008
	NOT-AUS	ZBY 8230	0.008

814318



ZBY 9130

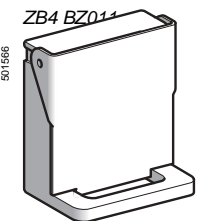
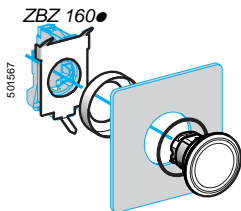
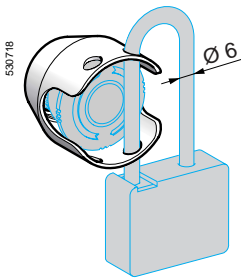
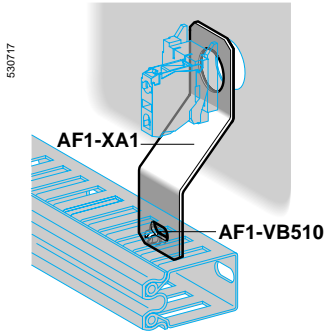

ZB4 BZ64

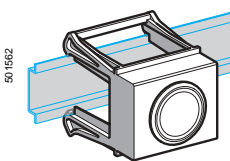

15151

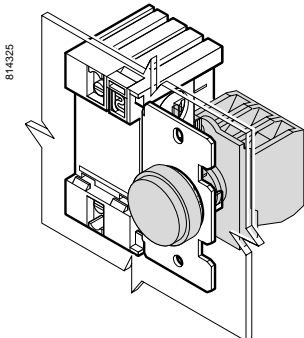

Accessories

Description	Application	Colour	Sold in lots of	Unit reference	Weight kg
Cable ducting support	Fixing beneath head		10	AF1 XA1	0.030
M5 x 10 screw, with hexagonal slotted head	For fixing cable ducting		100	AF1 VB510	0.003
Support	For pushbuttons, switches and pilot lights XB4 B		1	DX1 AP52	0.160
Metal guards Padlockable (1)	For Emergency Stop function only with the following Ø 40 trigger action pushbuttons: XB4 BT8●, XB4 BS8●, XB4 BS9●, ZB4 BT8●, ZB4 BS8●, ZB4 BS9●.	Chromium plated	1	ZBZ 1600	0.046
		Black	1	ZBZ 1602	0.046
		Red	1	ZBZ 1604	0.046
		Yellow	1	ZBZ 1605	0.046
		Blue	1	ZBZ 1606	0.046
Plastic guard	For selector switches with standard handle or key switches	Black	1	ZBZ 2102	0.005
Metal blanking plug, round, chromium plated (2)	For Ø 22 control and signalling units		10	ZB4 SZ3	0.023
Plastic blanking plug, round, black (3)	For Ø 22 control and signalling units		10	ZB5 SZ3	0.009
Mounting kit	For pushbuttons ZB4 B● with head mounted flush with bezel		1	ZB4 BZ011	0.007
Padlockable flaps	For pushbuttons	Black	1	ZB4 BZ62	0.076
		Red	1	ZB4 BZ64	0.076
		Yellow	1	ZB4 BZ65	0.076
		Blue	1	ZB4 BZ66	0.076
Pushbutton support	For 35 mm DIN rail, for use in modular enclosure (4)		1	15151	0.040

AS-Interface module for Ø 22 control and signalling units

Panel fixing, in conjunction with a Harmony pushbutton or switch

Description	Application	Reference	Weight kg
S7.F profile	4 inputs and 4 outputs direct supply from the bus	XBZ S43	0.100



(1) No isolation function is possible when this guard is fitted.

(2) Requires a **ZB4 BZ009** body/fixing collar for mounting, see page 36008/2.

(3) Supplied complete with fixing nut.

(4) Marketed under the Merlin Gerin brand.

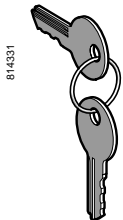
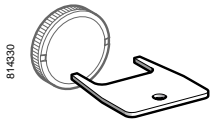

BA 9s bulbs and associated accessories

Description	Characteristics	Colour	Sold in lots of	Unit reference	Weight kg
LEDs	≈ 24 V	White	1	DL1 CJ0241	0.002
		Green	1	DL1 CJ0243	0.002
		Red	1	DL1 CJ0244	0.002
		Yellow	1	DL1 CJ0245	0.002
		Blue	1	DL1 CJ0246	0.002
	≈ 48 V	Green	1	DL1 CJ0483	0.002
		Red	1	DL1 CJ0484	0.002
		Yellow	1	DL1 CJ0485	0.002
	6 V -1.2 W	White	1	DL1 CD0061	0.002
		Green	1	DL1 CD0063	0.002
		Red	1	DL1 CD0064	0.002
		Yellow	1	DL1 CD0065	0.002
Blue		1	DL1 CD0066	0.002	
Incandescent bulbs	6 V -1.2 W	–	10	DL1 CB006	0.002
	24 V - 2 W	–	10	DL1 CE024	0.002
	120...130 V - 2. W	–	10	DL1 CE130	0.002
Neon bulbs	120...130 V	–	10	DL1 CF110	0.002
	230...240 V	–	10	DL1 CF220	0.002
Bulb extractor	–	–	1	XBF X13	0.005
Lens cap tightening tool	Illuminated pushbuttons, with flush push	–	1	ZBZ 8	0.009

Replacement keys for Emergency Stop key release heads and key switches

Description	Key number	Reference	Weight kg
Sets of 2 keys	455	ZBG 455	0.013
	421E	ZBG 421E	0.014
	458A	ZBG 458A	0.014
	520E	ZBG 520E	0.014
	3131A	ZBG 3131A	0.014

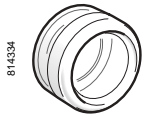

814334

ZBP 0

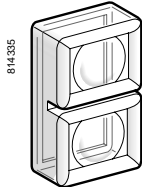

814335

ZBW 008

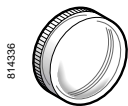

814336

ZBV 0103



814337

ZBV 010

Clear boots

Description	For use with pushbutton types	Sold in lots of	Unit reference	Weight kg
Single boots	Flush with circular head	10	ZBP A	0.002
	Projecting with circular head	10	ZBP 0	0.002
	Flush or projecting with circular head for food industry applications	10	ZBP 0A	0.002
Double boots	Flush or projecting double-headed pushbuttons	10	ZBW 008	0.005
	Flush double-headed pushbuttons	10	ZBW 008F	0.005
	Double-headed pushbuttons for food industry applications	10	ZBW 008A	0.005

Coloured boots

Description	Colour	Sold in lots of	Unit reference	Weight kg
Coloured boots (can be replaced without dismantling the head)	Black	10	ZB2 BP012	0.003
	Green	10	ZB2 BP013	0.003
	Red	10	ZB2 BP014	0.003
	Yellow	10	ZB2 BP015	0.003
	Blue	10	ZB2 BP016	0.003

Lens caps

For use on	Colour	Sold in lots of	Unit reference	Weight kg
Lens caps for light sources with integral LED				
Pilot lights	White	10	ZBV 0113	0.002
	Green	10	ZBV 0133	0.002
	Red	10	ZBV 0143	0.002
	Yellow	10	ZBV 0153	0.002
	Blue	10	ZBV 0163	0.002
	5 different coloured grooved lenses (1)	5	ZBV 0103S	0.010
Illuminated pushbuttons, with flush push	White	10	ZBW 9113	0.002
	Green	10	ZBW 9133	0.002
	Red	10	ZBW 9143	0.002
	Yellow	10	ZBW 9153	0.002
	Blue	10	ZBW 9163	0.002
Illuminated pushbuttons, with projecting push	White	10	ZBW 9313	0.002
	Green	10	ZBW 9333	0.002
	Red	10	ZBW 9343	0.002
	Yellow	10	ZBW 9353	0.002
	Blue	10	ZBW 9363	0.002

Lens caps for light sources with BA 9s base fitting

Pilot lights	White	10	ZBV 011	0.002
	Green	10	ZBV 013	0.002
	Red	10	ZBV 014	0.002
	Yellow	10	ZBV 015	0.002
	Blue	10	ZBV 016	0.002
	Clear	10	ZBV 017	0.002
Illuminated pushbuttons, with flush push	White	10	ZBW 911	0.002
	Green	10	ZBW 913	0.002
	Red	10	ZBW 914	0.002
	Yellow	10	ZBW 915	0.002
	Blue	10	ZBW 916	0.002
	Clear	10	ZBW 917	0.002
Illuminated pushbuttons, with projecting push	White	10	ZBW 931	0.002
	Green	10	ZBW 933	0.002
	Red	10	ZBW 934	0.002
	Yellow	10	ZBW 935	0.002
	Blue	10	ZBW 936	0.002
	Clear	10	ZBW 937	0.002

(1) Clear, green, red, yellow, blue.



XB4 BA801

Manual overload reset buttons (1)

With flush push

Shape of head	Travel mm	Actuation distance mm	Colour	Reference	Weight kg
	10	6...16	Black	XB4 BA821	0.037
			Red	XB4 BA841	0.037
			Blue	XB4 BA861	0.037
	16...26	16...26	Black	XB4 BA822	0.038
			Red	XB4 BA842	0.038
			Blue	XB4 BA862	0.038
	14	30...130	Black	XB4 BA921	0.058
			Red	XB4 BA941	0.058
			Blue	XB4 BA961	0.058
	130...257	130...257	Black	XB4 BA922	0.071
			Red	XB4 BA942	0.071
			Blue	XB4 BA962	0.071



ZB4 BD912

Heads + mounting base for potentiometer

Shape of head	Description	Application	Reference	Weight kg
	For potentiometer with shaft length 44 to 50 mm (potentiometer not included)	For shaft Ø 6 mm	ZB4 BD912	0.080
		For shaft Ø 6.35 mm	ZB4 BD922	0.080

(1) NEMA type 13
(2) Cap to be ordered separately, see page 36008/6.

		Joystick controllers (54 mm long operating shaft) (1)				
		Description	Operation	Spring return to zero position	Reference	Weight kg
 <p>814342</p> <p>XD4 PA12</p>	Complete joystick controllers (screw clamp terminal connections)					
	2 direction	1 notch 1 N/O contact per direction	Without	XD4 PA12	0.116	
			With	XD4 PA22	0.116	
	4 direction	1 notch 1 N/O contact per direction	Without	XD4 PA14	0.133	
With			XD4 PA24	0.133		
		Sub-assemblies for joystick controllers				
		Description	Functions	Reference	Weight kg	
 <p>814346</p> <p>ZD4 PA103</p>	Complete body/contact assemblies (screw clamp terminal connections)	2 direction	ZD4 PA103	0.049		
		4 direction	ZD4 PA203	0.058		
 <p>814346</p> <p>ZD4 PA203</p>	Complete head assemblies with operating shaft	2 direction, stay put	ZD4 PA12	0.022		
		2 direction, spring return to zero position	ZD4 PA22	0.022		
		4 direction, stay put	ZD4 PA14	0.022		
		4 direction, spring return to zero position	ZD4 PA24	0.022		
 <p>814347</p> <p>ZD4 PA12</p>	Legends 30 x 48 mm for engraving	2 direction	Black one side Red reverse	ZBG 2201	0.001	
		4 direction	White one side Yellow reverse	ZBG 2401	0.001	
 <p>814347</p> <p>ZD4 PA12</p>	Legends 48 x 48 mm for engraving	4 direction	Black one side Red reverse	ZBG 4201	0.002	
		White one side Yellow reverse	ZBG 4401	0.002		
		Hour counters (2)				
		Characteristics	Supply voltage V	Reference	Weight kg	
 <p>814343</p> <p>XB5 DS●</p>	Indication 0...9999.9	≈ 12...24 - 50/60 Hz	XB5 DSB	0.045		
		~ 120 - 60 Hz	XB5 DSG	0.045		
		~ 230...240 - 50 Hz	XB5 DSM	0.045		
 <p>814344</p> <p>XB5 KS●</p>	Annunciators (IP 40 NEMA 1) (2) 85 db buzzer, basic: 4 kHz, with continuous or intermittent operation (connection diagram: see page 36020/8)	≈ 24 - 50/60 Hz	XB5 KSB	0.035		
		~ 120 - 50/60 Hz	XB5 KSG	0.035		
		~ 230...240 - 50 Hz	XB5 KSM	0.035		
		Fuse carrier (2)				
		Description	For use with	Reference	Weight kg	
 <p>814344</p> <p>XB5 DT1S</p>	Fuse carrier	5 x 20 mm fuse 6.3 A - 250 V	XB5 DT1S	0.022		
<p>(1) Cannot be used with standard contact blocks ZBE 101 (single) or ZBE 20● (double). (2) Replacement parts: fixing nut ZB5 AZ901, anti-rotation plate: ZB5 AZ902, tightening key: ZB5 AZ905.</p>						
Other versions		Joystick controllers and complete body/contact assemblies for joystick controllers with Faston connector terminals (6.35 or 2 x 2.8). Please consult your Regional Sales Office.				

Control and signalling units Ø 22

Harmony® style 4

Pushbuttons, switches and pilot lights with chromium plated metal bezel

Complete units, XB4 B : contact functions

Pushbuttons, spring return

XB4 BA●●

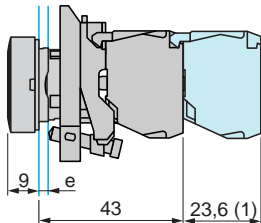

XB4 BL●●

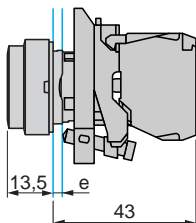

Common face view

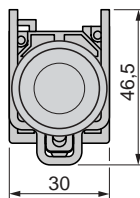

XB4 BP●●

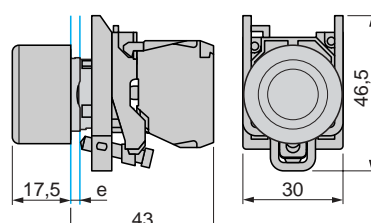

Mushroom head pushbuttons, spring return

XB4 BC21

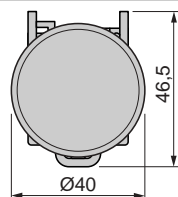
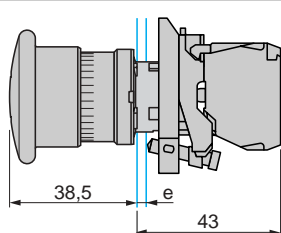

Double-headed pushbuttons, spring return

XB4 BL●45, BL●4C5

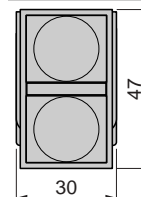
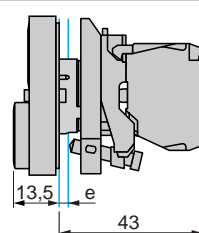

e: panel thickness: 1 to 6 mm

(1) Additional row of contacts or double contact.

Emergency stop mushroom head pushbuttons

XB4 BT42, BT845

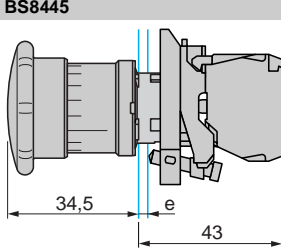
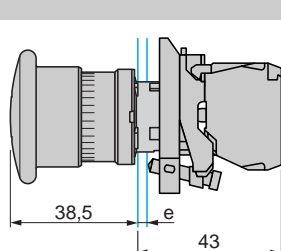

XB4 BS142, BS9445

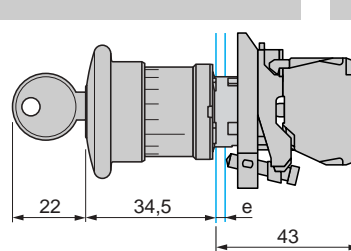

Common face view

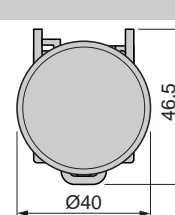

e: panel thickness: 1 to 6 mm

Selector switches

Standard handle operator

XB4 BD

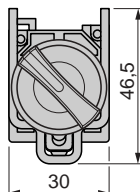
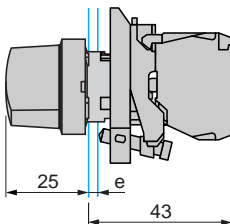

Long handle operator

XB4 BJ

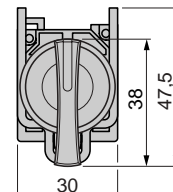
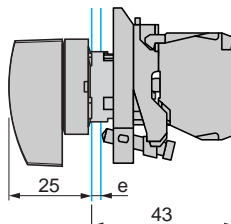

Key switches

XB4 BG

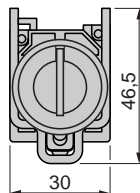
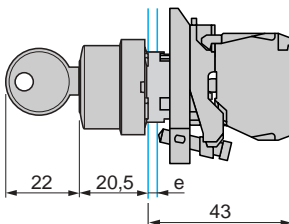

Heads for toggle switches

ZB4 BD●8

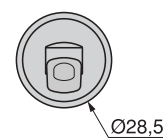
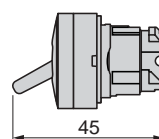

e: panel thickness: 1 to 6 mm

Pilot lights

Integral LED

XB4 BVB●, BVG●, BVM●

Direct supply

XB4 BV6

Via integral transformer

XB4 BV3●, BV4●

Common face view

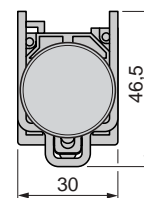
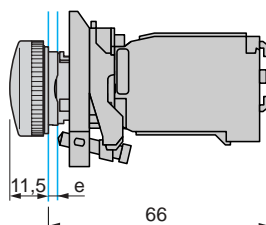
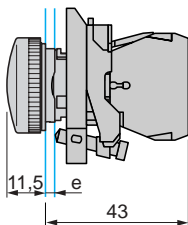
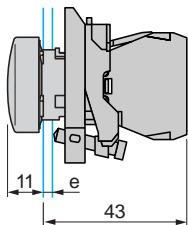

e: panel thickness: 1 to 6 mm

Illuminated pushbuttons

Integral LED

XB4 BWB3●●5

Direct supply

XB4 BW3●65

Via integral transformer

XB4 BW3●●5

Common face view

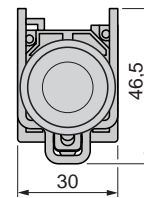
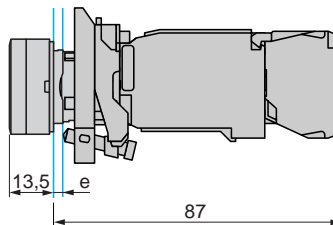
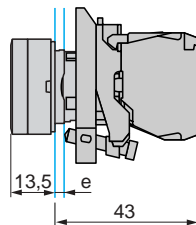
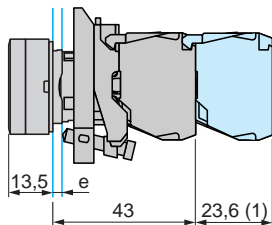

Double-headed pushbuttons with pilot light

Integral LED

XB4 BW84●5

Illuminated selector switches

Integral LED

XB4 BK12●●5

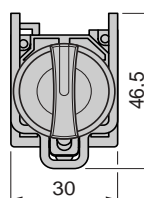
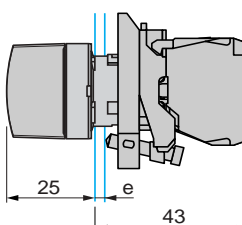
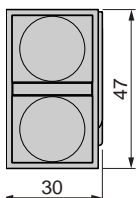
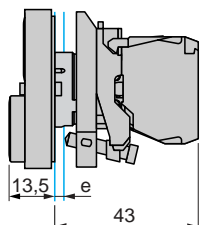

e: panel thickness: 1 to 6 mm

(1) Additional row of contacts or double contact

Panel cut-out for pushbuttons, switches and pilot lights (2)

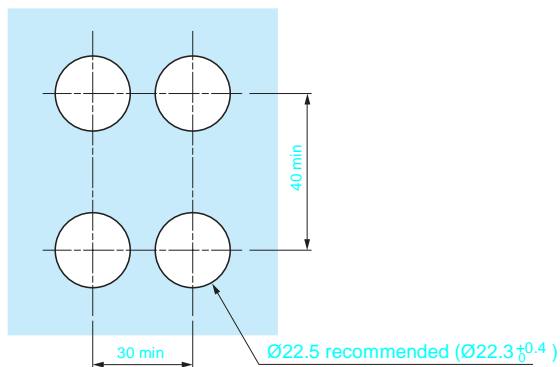

(2) Fixing centres for pushbuttons, switches and pilot lights fitted with Faston connector terminals: 32 x 45 min.

Control and signalling units Ø 22

Harmony® style 4

Pushbuttons, switches and pilot lights with chromium plated metal bezel

Sub-assemblies ZB4 B : contact functions

Heads for spring return pushbuttons

ZB4 BA●, BA●●, Z B4 BA●8 ZB4 BL●, BL●● ZB4 BA●4 Z B4 BA●6 Common face view ZB4 BP●● Z B4 BP●S

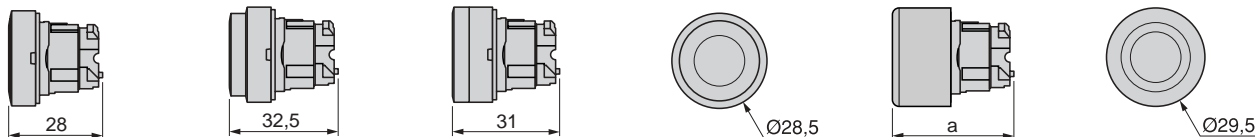

ZB4	a
BP●●	36,5
BP●S	33

Heads for double-headed, spring return pushbuttons

ZB4 BA81●● Z B4 BA82●● ZB4 BL83●● Z B4 BL84●● Common face view ZB4 BA91●● Z B4 BA92●● ZB4 BL93●● Z B4 BL94●● Common face view

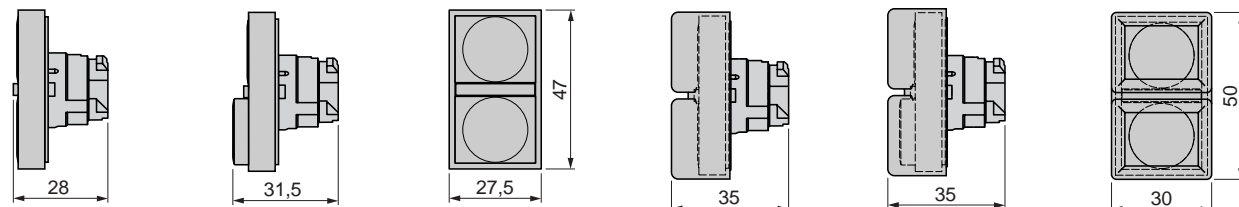

Heads for pushbuttons

Push-push to release **Mushroom head**
 ZB4 BH0● ZB4 BH● Common face view ZB4 BC●4 ZB4 BC●, BR●

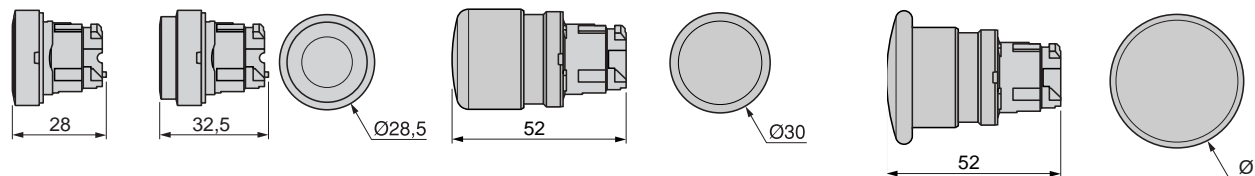

ZB4	Ø
BC●	40
BR●	60

Mushroom heads for latching pushbuttons

Push-pull
 ZB4 BT●, BT●4 ZB4 BX2, BX4 ZB4 BR●16

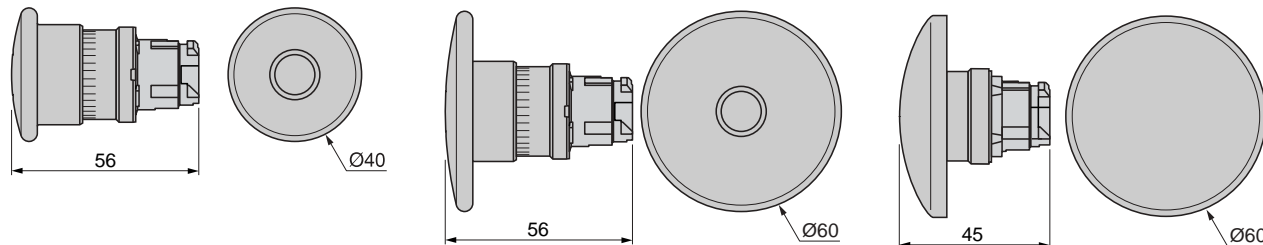

Turn to release

ZB4 BS4●, BS834 ZB4 BS5●, BS844, BS6●

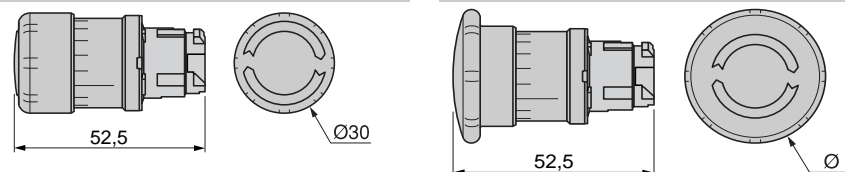

ZB4	Ø
BS5●, BS844	40
BS6●	60

Mushroom heads for latching pushbuttons (continued)

Key release

ZB4 BS7●, BS934

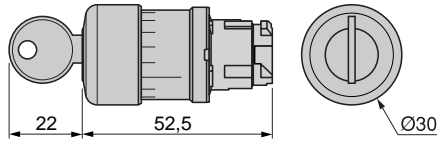

ZB4 BS1●, BS2●, BS944, BS964

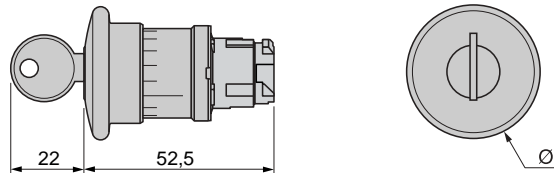

ZB4	Ø
BS1●, BS944	40
BS2●, BS964	60

Heads for selector switches

Standard handle operator

ZB4 BD●, BD0●M

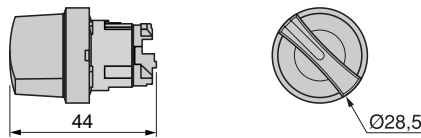

Long handle operator

ZB4 BJ●, BD0●M



Knurled knob, black

ZB4 BD●9

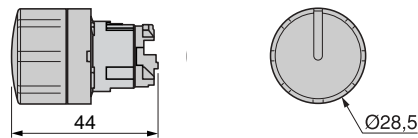

Key switches

ZB4 BG●, BG0●, BG0●M



Bodies for pushbuttons and switches

Screw clamp terminal connections

ZB4 BZ10●, BZ141

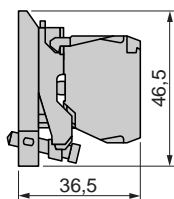

Plug-in connector

ZB4 BZ10●4, BZ1414

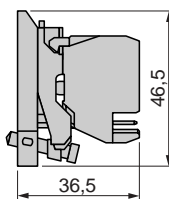

Control and signalling units Ø 22

Harmony® style 4

Pushbuttons, switches and pilot lights with chromium plated metal bezel

Sub-assemblies ZB4 B : signalling functions without contacts

Heads for pilot lights, with light source

Integral LED

ZB4 BV0●3, BV0●3S

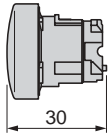

Incandescent, neon or LED

ZB4 BV0●, BV0●S

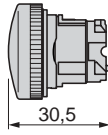

Common face view

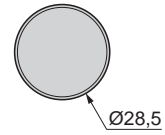

Bodies for pilot lights, screw clamp terminal connections

Integral LED

ZB4 BV●●

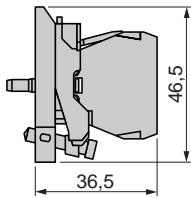

Direct supply, for BA 9s bulb

ZB4 BV6

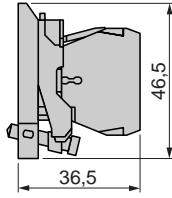

Via integral transformer for BA 9s bulb

ZB4 BV●, BV●D●

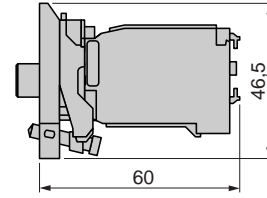

Bodies for pilot lights, plug-in connector

Integral LED

ZB4 BV●●4

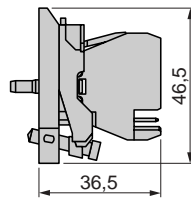

Control and signalling units Ø 22

Harmony® style 4

Pushbuttons, switches and pilot lights with chromium plated metal bezel

Sub-assemblies ZB4 B : signalling functions with or without contacts

Heads for spring return illuminated pushbuttons, for light source

LED

ZB4 BW3●●3, BW3●3S Z B4
BW5●3, BA●8

ZB4 BW1●3
Z B4 BL●8

Common face view

ZB4 BW9●3

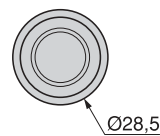
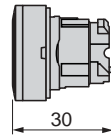
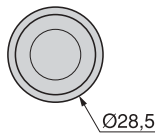
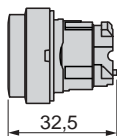
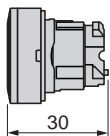

Incandescent or neon

ZB4 BW3●3, BW3●S

ZB4 BW1●

Common face view

Heads for Ø 40 mm mushroom head illuminated pushbuttons with LED

ZB4 BW4●3, BW6●3

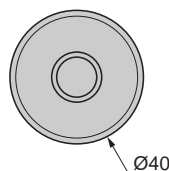
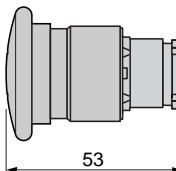
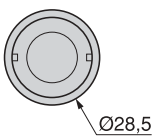
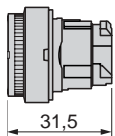
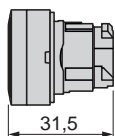

Heads for double-headed pushbuttons with pilot light

ZB4 BW81●●●3,
Z B4 BW82●●●3

ZB4 BW83●●●3,
Z B4 BW84●●●3

Common face view

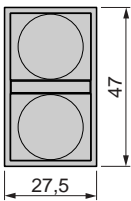
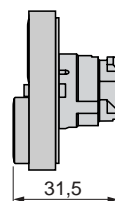
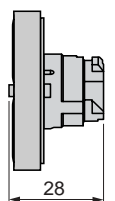

Heads for illuminated "push-push to release" pushbuttons

ZB4 BH0●3

ZB4 BH●3

Common face view

Heads for illuminated selector switches with standard handle

ZB4 BK1●●●3

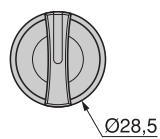
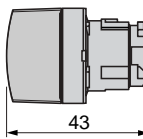
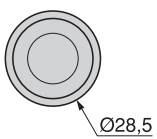
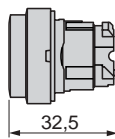
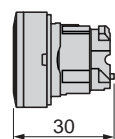

Bodies for illuminated pushbuttons and switches

Screw clamp terminal connections

Integral LED

Direct supply for BA 9s bulbs

Via integral transformer for BA 9s bulbs

Plug-in connector
Integral LED

ZB4 BW0●●●

ZB4 BW0●●

ZB4 BW0●●, BW0●D●●

ZB4 BW0●●●4

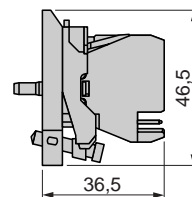
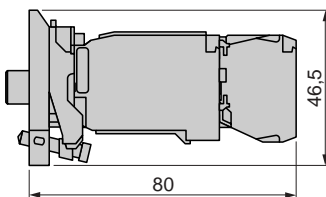
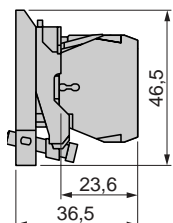
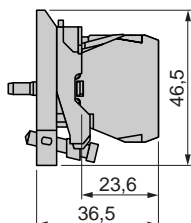

Control and signalling units Ø 22

Harmony® style 4

Pushbuttons, switches and pilot lights with chromium plated metal bezel

Specific functions

Manual overload reset buttons

XB4 BA9●●

Common face view

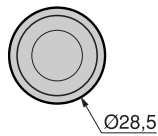
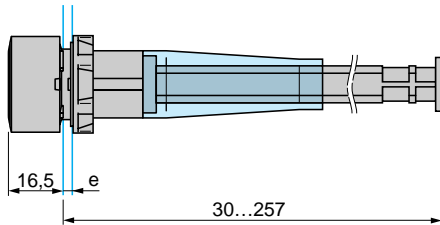

Head + mounting base for potentiometer

ZB4 BD9●2

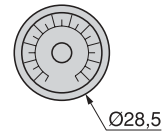
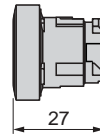

XB4 BA8●●

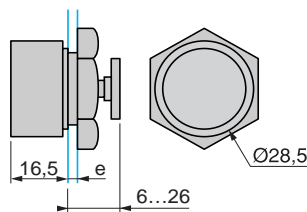

e: panel thickness 1 to 6 mm

Joystick controllers

XD4 PA●2

XD4 PA●4

Common face view

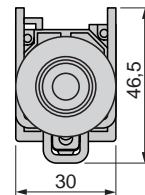
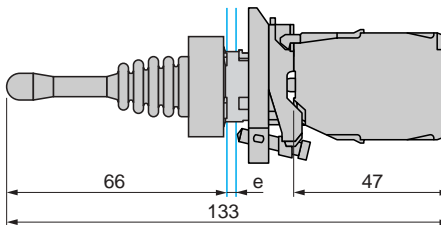
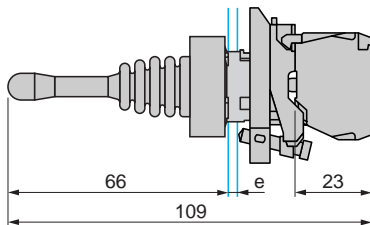

e: panel thickness 1 to 6 mm

Hour counters

XB5 DS●

Annunciators

XB5 KS●

Connection diagram

XB5 KS●

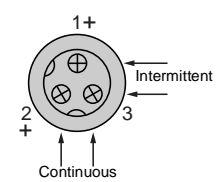
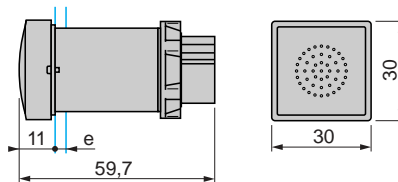
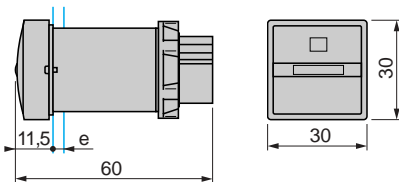

e: panel thickness 1 to 6 mm

Pushbuttons, switches and pilot lights for printed circuit board connection

Panel cut-out (viewed from installer's side)

Dimensions in mm

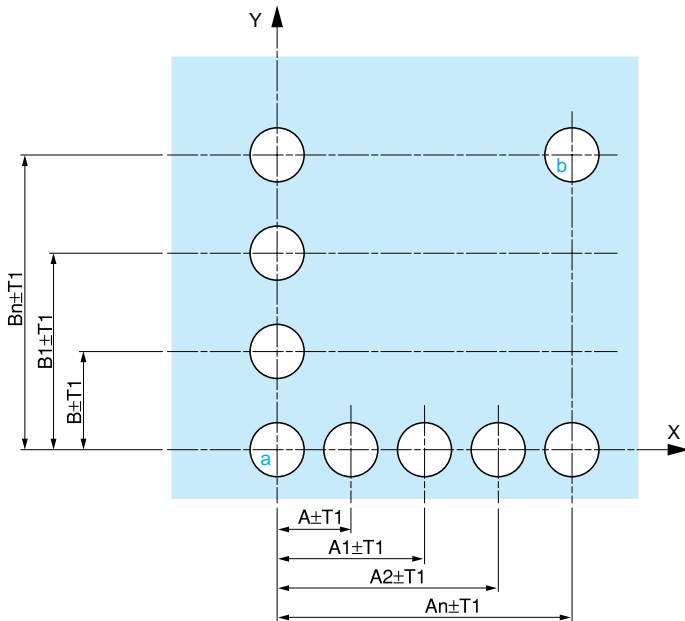

Printed circuit board drillings (viewed from electrical block side)

Dimensions in mm

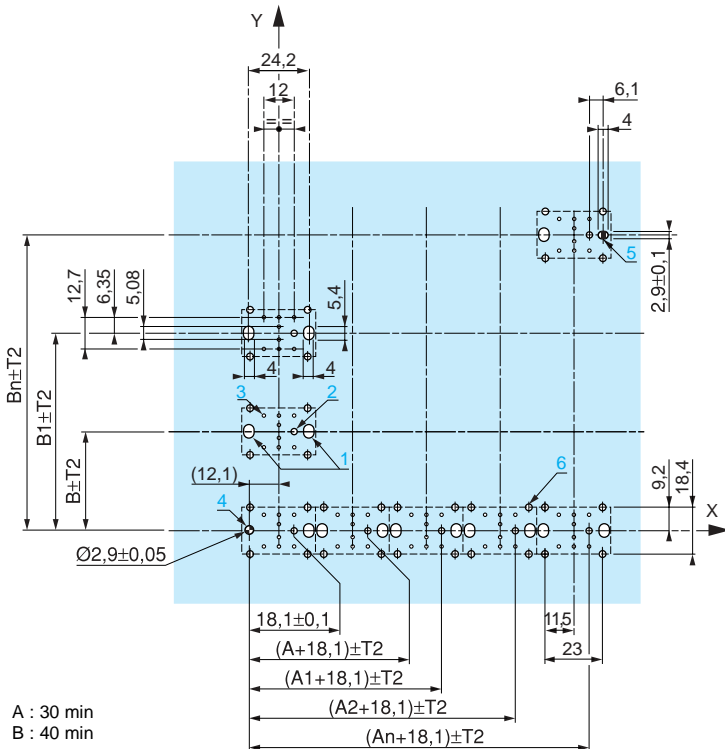

General tolerances of the panel and printed circuit board

The cumulative tolerance must not exceed 0.3 mm: $T1 + T2 = 0.3$ mm max.

Installation precautions:

Minimum thickness of circuit board: 1.6 mm.

Cut-out diameter: $22.5 \text{ mm} \pm 0.1 \text{ mm}$.

Orientation of body/fixing collar ZB4 BZ009: $\pm 2^\circ 30'$ (excluding cut-outs marked **a** and **b**).

Tightening torque of screws ZBZ 006: 0.6 N.m

Allow for one ZB4 BZ079 pillar and its fixing screws:

- every 90 mm horizontally (X) and every 120 mm vertically (Y).
- with each selector switch head (ZB4 BD●, ZB4 BJ●, ZB4 BG●).

The fixing centres marked **a** and **b** are diagonally opposed and must align with those marked **4** and **5** on the printed circuit board.

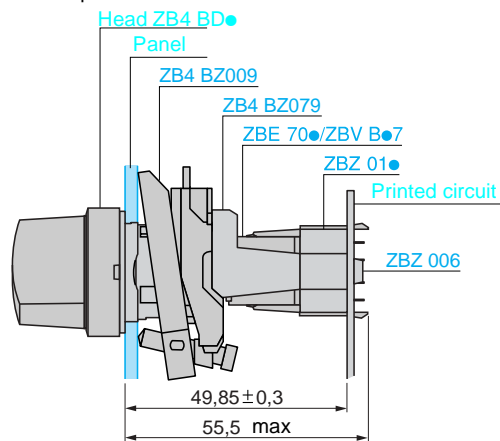

Mounting of adaptor (socket) ZBZ 01● :

- 1 2 elongated holes for ZBZ 006 screw access.
- 2 1 hole $\text{Ø} 2.4 \text{ mm} \pm 0.05$ for centring adaptor ZBZ 01●.
- 3 8 x $\text{Ø} 1.2 \text{ mm}$ holes.
- 4 1 hole $\text{Ø} 2.9 \text{ mm} \pm 0.05$, for centring the printed circuit board (with cut-out marked **a**).
- 5 1 elongated hole $\text{Ø} 2.9 \text{ mm} \pm 0.05$, for orientation of the printed circuit board (with cut-out marked **b**).
- 6 4 holes $\text{Ø} 2.4 \text{ mm} \pm 0.05$ for clipping in adaptor ZBZ 01●.

Dimensions $A_n + 18.1$ relate to the $\text{Ø} 2.4 \text{ mm} \pm 0.05$ holes for centring adaptor ZBZ 01●.

Schneider Electric Industries SAS

Headquarters

89, bd Franklin Roosevelt
F - 92506 Rueil Malmaison Cedex

<http://www.schneider-electric.com>

Owing to changes in standards and equipment, the characteristics given in the text and images in this document are not binding until they have been confirmed with us.

Production : Schneider Electric Industries
Photos : Schneider Electric Industries
Printed by : CCI



April 2004