



User's Manual

Copyright and Trademarks

Disclaimer

This manual is proprietary to **Brady** Worldwide, Inc. (hereafter "**Brady**"), and may be revised from time to time without notice. **Brady** disclaims any understanding to provide you with such revisions, if any.

This manual is copyrighted with all rights reserved. No portion of this manual may be copied or reproduced by any means without the prior written consent of **Brady**.

While every precaution has been taken in the preparation of this document, **Brady** assumes no liability to any party for any loss or damage caused by errors or omissions or by statements resulting from negligence, accident, or any other cause. **Brady** further assumes no liability arising out of the application or use of any product or system described, herein; nor any liability for incidental or consequential damages arising from the use of this document. **Brady** disclaims all warranties of merchantability of fitness for a particular purpose.

Brady reserves the right to make changes without further notice to any product or system described herein to improve reliability, function, or design.

Trademarks

BBP™31 is a trademark of **Brady** Worldwide, Inc.

Microsoft, Windows, Excel, Access and SQL Server are registered trademarks of Microsoft Corporation.

Lotus 1-2-3 is a registered trademark of Lotus Development Corporation.

All brand or product names referenced in this manual are trademarks (™) or registered trademarks (®) of their respective companies or organizations.

© 2010 **Brady Corporation**. All Rights Reserved.

Y1097081
Revision A

Brady Corporation
6555 West Good Hope Road
P.O. Box 2131
Milwaukee, WI 53201-2131
www.bradycorp.com

Sales/Customer Support:(800) 537-8791

End User License Agreement for Microsoft Windows CE®

You have acquired a device that includes software licensed by Brady Worldwide, Inc. from Microsoft Licensing or its affiliates (“MS”). Those installed software products of Microsoft origin, as well as associated media, printed materials, and “online” or electronic documentation (“SOFTWARE”) are protected by international intellectual property laws and treaties. The SOFTWARE is licensed, not sold. All rights reserved.

IF YOU DO NOT AGREE TO THIS END USER LICENSE AGREEMENT, DO NOT USE THE DEVICE OR COPY THE SOFTWARE. INSTEAD, PROMPTLY CONTACT BRADY WORLDWIDE, INC. FOR INSTRUCTIONS ON RETURN OF THE UNUSED DEVICE FOR A REFUND. **ANY USE OF THE SOFTWARE, INCLUDING BUT NOT LIMITED TO USE ON THE DEVICE, WILL CONSTITUTE YOUR AGREEMENT TO THIS END USER LICENSE AGREEMENT (OR RATIFICATION OF ANY PREVIOUS CONSENT).**

GRANT OF SOFTWARE LICENSE: This End User License Agreement grants you the following license:

You may use the SOFTWARE only on the DEVICE.

NOT FAULT TOLERANT. THE SOFTWARE IS NOT FAULT TOLERANT. BRADY WORLDWIDE, INC. HAS INDEPENDENTLY DETERMINED HOW TO USE THE SOFTWARE IN THE DEVICE, AND MS HAS RELIED UPON BRADY WORLDWIDE, INC. TO CONDUCT SUFFICIENT TESTING TO DETERMINE THAT THE SOFTWARE IS SUITABLE FOR SUCH USE.

NO WARRANTIES FOR THE SOFTWARE. **The SOFTWARE is provided “as is” and with all faults. THE ENTIRE RISK AS TO SATISFACTORY QUALITY, PERFORMANCE, ACCURACY, AND EFFORT (INCLUDING LACK OF NEGLIGENCE) IS WITH YOU. ALSO, THERE IS NO WARRANTY AGAINST INTERFERENCE WITH YOUR ENJOYMENT OF THE SOFTWARE OR AGAINST INFRINGEMENT.** IF YOU HAVE RECEIVED ANY WARRANTIES REGARDING THE DEVICE OR THE SOFTWARE, THOSE WARRANTIES DO NOT ORIGINATE FROM, AND ARE NOT BINDING ON, MS.

Note on Java support. The SOFTWARE may contain support for programs written in Java. Java technology is not fault tolerant and is not designed, manufactured, or intended for use or resale as online control equipment in hazardous environments requiring fail-safe performances, such as in the operation of nuclear facilities, aircraft navigation or communication systems, air traffic control, direct life support machines, or weapons systems, in which the failure of Java technology could lead directly to death, personal injury, or severe physical or environmental damage. Sun Microsystems, Inc. has contractually obligated MS to make this disclaimer.

No Liability for Certain Damages. EXCEPT AS PROHIBITED BY LAW, MS SHALL HAVE NO LIABILITY FOR ANY INDIRECT, SPECIAL, CONSEQUENTIAL OR INCIDENTAL DAMAGES ARISING FROM OR IN CONNECTION WITH THE USE OR PERFORMANCE OF THE SOFTWARE. THIS LIMITATION SHALL APPLY EVEN IF ANY REMEDY FAILS OF ITS ESSENTIAL PURPOSE. IN NO EVENT SHALL MS BE LIABLE FOR ANY AMOUNT IN EXCESS OF U.S. TWO HUNDRED FIFTY DOLLARS (U.S.\$250.00).

Limitations on Reverse Engineering, Decompilation, and Disassembly. You may not reverse engineer, decompile, or disassemble the SOFTWARE, except and only to the extent that such activity is expressly permitted by applicable law notwithstanding this limitation.

SOFTWARE TRANSFER ALLOWED BUT WITH RESTRICTIONS. You may permanently transfer rights under this End User License Agreement only as part of a permanent sale or transfer of the Device, and only if the recipient agrees to this End User License Agreement. If the SOFTWARE is an upgrade, any transfer must also include all prior versions of the SOFTWARE.

EXPORT RESTRICTIONS. You acknowledge that SOFTWARE is of US-origin. You agree to comply with all applicable international and national laws that apply to the SOFTWARE, including the U.S. Export Administration Regulations, as well as end-user, end-use, and country destination restrictions issued by U.S. and other governments. For additional information on exporting the SOFTWARE, see <http://www.microsoft.com/exporting/>.

Brady Warranty

Our products are sold with the understanding that the buyer will test them in actual use and determine for him or herself their adaptability to his/her intended uses. Brady warrants to the buyer that its products are free from defects in material and workmanship, but limits its obligation under this warranty to replacement of the product shown to Brady's satisfaction to have been defective at the time Brady sold it. This warranty does not extend to any persons obtaining the product from the buyer.

THIS WARRANTY IS IN LIEU OF ANY OTHER WARRANTY, EXPRESS OR IMPLIED, INCLUDING, BUT NOT LIMITED TO, ANY IMPLIED WARRANTY OF MERCHANTABILITY OR FITNESS FOR A PARTICULAR PURPOSE, AND OF ANY OTHER OBLIGATIONS OR LIABILITY ON BRADY'S PART. UNDER NO CIRCUMSTANCES WILL BRADY BE LIABLE FOR ANY LOSS, DAMAGE, EXPENSE OR CONSEQUENTIAL DAMAGES OF ANY KIND ARISING IN CONNECTION WITH THE USE, OR INABILITY TO USE, BRADY'S PRODUCTS.

Agency Compliance and Approvals

United States

FCC Notice-US Only

Warning: This equipment generates, uses and can radiate radio frequency energy. If not installed and used in accordance with the manufacturer's instructions, it may cause interference to radio communications. It has been tested and found to comply with the limits for a Class A computing device pursuant to Subpart B of Part 15 of the FCC rules, which are designed to provide reasonable protection against interference when operating in a commercial environment. Operation of this equipment in a residential area is likely to cause interference, in which case required corrective measures will be at the owner's expense. The user is cautioned that any changes or modifications not expressly approved by Brady Worldwide, Inc. could void the user's authority to use the equipment.

Canada

ICES-003 Class A Notice, Classe A

This Class A digital apparatus meets all requirements of the Canadian Interference-Causing Equipment Regulations.

Cet appareil numérique de la classe A respecte toutes les exigences du Règlement sur le matériel brouilleur du Canada.

Europe

Warning – This is a Class A product. In a domestic environment this product may cause radio interference, in which case the user may be required to take adequate measures.



Waste Electrical and Electronic Equipment Directive

In accordance with the European WEEE Directive, this device must be recycled in the European Union country in which it was purchased.

RoHS Directive 2002/95/EC

This statement clarifies **Brady's** product compliance with the European Union's Directive 2002/95/EC, Restriction of Hazardous Substances

Safety and Environment

Please read and understand this manual before using the **BBP™31 Sign & Label Printer** for the first time. This manual describes all of the main functions of the **BBP™31** printer.

Precautions

Before using the **BBP™31** printer, please note the following precautions:

- Read all instructions carefully before operating the printer and prior to performing any procedure.
- Do not place the unit on an unstable surface or stand.
- Do not place anything on top of the unit.
- Keep the top clear of obstructions.
- Always use the printer in a well ventilated area. Do not block the slots and opening on the unit, which are provided for ventilation.
- Only use the power source indicated on the rating label.
- Use only the power cord that comes with the unit.
- Do not place anything on the power cord.

Technical Support and Registration

Contact Information

For repair or technical assistance, locate your regional **Brady** Technical Support office by going to:

- **Americas:** www.bradyid.com
- **Europe:** www.bradyeurope.com
- **Asia Pacific:** www.bradycorp.com

Registration Information

To register your printer, go to www.bradycorp.com/register.

Repair and Return

If for any reason you need to return the **BBP™31** printer for repair, please contact **Brady** Technical Support for repair and replacement information.

Overview

About this Document

The purpose of this guide is to provide information and instructions on using the **BBP™31 Sign & Label Printer**.

Conventions

When using this document, it is important that you understand the conventions used throughout the manual.

- All User actions are indicated by **Bold** text.
- References to Menus, dialog boxes, button and screens are indicated by *Italics* text.
- See “*About Menus, Dialog Boxes and Screens*” on page 1-4 for a description of the menus and controls.

Contents

Copyright and Trademarks	iii
End User License Agreement for Microsoft Windows CE®.....	iv
Brady Warranty	v
Agency Compliance and Approvals.....	vi
Safety and Environment.....	vii
Technical Support and Registration	viii
Overview	ix
1 - Introduction	
Features and Functions	1-1
Compatible Applications.....	1-2
System Specifications.....	1-2
Keyboard Configurations.....	1-3
About Menus, Dialog Boxes and Screens	1-4
Home Page	1-4
Tools Panel	1-5
Menu	1-6
Control Panel	1-7
Button Actions	1-8
Available Label Types	1-9
2 - Setting up Your Printer	
Unpacking and Setting up Printer	2-1
What's in the Box	2-1
System Components	2-2
Setting up the Printer	2-3
<i>Connect Printer Power</i>	<i>2-3</i>
<i>Install or Change Supplies</i>	<i>2-4</i>
Feeding and Cutting Label Stock	2-8
System Power	2-9
Starting Printer from a Non-powered (Cold) State	2-9
Waking the Printer from Sleep Mode	2-9
Powering Off the Printer	2-10
Resetting the Printer	2-10
Creating Your First Label.....	2-11
Using Your Printer with a PC.....	2-12
Installing USB Driver	2-12
Creating and Printing Labels from a PC	2-12

Setting up the System Defaults	2-13
<i>Set Clock</i>	2-14
<i>Localization and Unit of Measure</i>	2-15
<i>Set Text Defaults</i>	2-16
<i>Set Barcode Defaults.....</i>	2-17
<i>Set Printing.....</i>	2-18
Customizing Home Page Defaults	2-19
Displaying System Information.....	2-20

3 - Working with Labels

Create Labels.....	3-1
Creating a Label from a Template	3-1
Creating a Custom Label	3-3
Set Label Attributes	3-4
Creating Fixed-Length Label	3-4
Creating Auto-Sized Label	3-4
Orientation	3-5
Framing a Label	3-6
Tools.....	3-7
Zooming the Label View	3-7
Scrolling the Label View	3-7

4 - Working with Objects

Overview	4-1
What is an Object?	4-1
Object Types	4-1
Undo	4-2
Object Sizing	4-2
Adding Objects.....	4-3
Text Objects	4-3
Graphic Objects	4-4
Barcode Objects	4-5
Serial Objects	4-6
Date/Time Objects	4-8
Working with Text	4-10
Selecting or Deselecting Text	4-10
Increase or Decrease Text Size	4-11
Delete/Clear Text	4-11
Changing Character Font, Size or Style	4-12
Horizontal Text Justification	4-14
Vertical Text	4-14
Expanding or Condensing Text	4-15
Reversing Text	4-15
Typing Text and Accented Characters	4-16
<i>Understanding Keystroke Combinations</i>	4-16
<i>Typing Accented Characters</i>	4-17
Entering Special Characters	4-18

Working with Barcodes	4-19
Changing a Barcode	4-19
Changing Barcode Options	4-20
<i>Barcode Size</i>	4-20
<i>Barcode Ratio</i>	4-20
<i>Barcode Density</i>	4-21
<i>Human-Readable Text Options</i>	4-22
Handling Objects	4-23
Editing Objects	4-23
Moving Objects	4-23
<i>Drag Objects</i>	4-23
<i>Use Keyboard Arrow Keys</i>	4-23
<i>Set Object Position</i>	4-24
Aligning Objects	4-25
Sizing Objects	4-26
<i>Use Size Buttons</i>	4-26
<i>Drag Objects to Size</i>	4-27
<i>Set Object Size</i>	4-28
Deleting an Object	4-29
Framing an Object	4-29
Rotating an Object	4-30
Converting Text or Barcode to Variable Data	4-31
<i>Convert to Serial Data</i>	4-31
<i>Convert from Serial Data</i>	4-33
<i>Convert to Date/Time</i>	4-34
Convert from Date/Time	4-35
5 - Printing Your Labels	
Previewing Labels.....	5-1
Previewing a Label without Serialized Objects	5-1
Previewing a Label with Serialized Objects	5-2
Printing Labels	5-3
Printing Labels without Serialized Objects	5-3
Printing Labels with Serialized Objects	5-4
Printing Mirror-Image Labels	5-5
Canceling a Print Job	5-5
Resuming an Interrupted Print Job	5-6
Adjusting Print Energy	5-7
Adjusting Print Offset	5-8
Printing from a PC	5-9
6 - Working with Label Files	
Save a Label File	6-1
Open a Label File	6-2
Delete a Label File.....	6-3

7 - Using System Tools

Import Graphics	7-1
Delete Imported Graphics	7-3
Import Fonts	7-4
Printer Upgrades	7-5
Installing Software Upgrades	7-5
Upgrade from a PC	7-5
Upgrade from USB Flash Drive	7-6

8 - Maintenance

Printer Maintenance	8-1
Removing Power and Media from Printer	8-1
Cleaning the Printer	8-3
<i>Cleaning Residue from Printer and Keyboard</i>	8-3
<i>Cleaning the Touch Screen</i>	8-4
<i>Cleaning the Cutter Blade</i>	8-5
<i>Cleaning the Sensors</i>	8-7
<i>Cleaning the Cutter Blade Exit Area</i>	8-8
<i>Dust Cleaning</i>	8-9
<i>Cleaning the Printhead</i>	8-10
Replacing the Media Wiper	8-11
Clearing Jams	8-12

9 - Troubleshooting

Messages	9-1
Problem Resolution	9-2
Hardware Errors	9-2
Media Errors	9-3
Ribbon Errors	9-3
Power Errors	9-4
Printing Errors	9-5

A - Glossary of Terms

B - Character Mapping & Keyboard Layouts

Character Mapping	B-1
Americas QWERTY	B-1
European AZERTY	B-2
European QWERTZ	B-3
European QWERTY	B-4
European Cyrillic	B-4
Keyboard Layouts	B-4

C - Specialty Label Types

Pipe Markers.....C-1
 Set Up Pipe Marker OptionsC-1
 Create Pipe Marker LabelsC-3
 Save, Open or Delete a Pipe Marker LabelC-10

QuickLabels.....C-11
 Creating Quick LabelsC-11

Quick Label Reference Images.....C-13
 Admittance, Exit, Confined SpacesC-13
 Alerts and First AidC-14
 Chemical - Hazardous MaterialsC-14
 Conduit - VoltageC-15
 Electrical Hazard - LockoutC-15
 FireC-16
 Funny SignsC-16
 Graphics - MandatoryC-17
 Graphics - PackagingC-18
 Graphics - PPEC-18
 Graphics - ProhibitionC-19
 Graphics - Signal WordsC-20
 Graphics - WarningC-21
 InspectionC-21
 Machine - OperationalC-22
 No SmokingC-22
 Pipe Marker ArrowsC-22
 Pipe MarkersC-23
 ProtectiveC-25
 Warning StakesC-25

Right to Know.....C-26

Arc Flash.....C-26

WHMIS.....C-26

D - Material Ribbon Cross Reference

1 Introduction

Thank you for purchasing the **BBP™31 Sign & Label Printer**, which you can use to create and print professional-looking industrial labels and signs. All you have to do is:

- Drop in a ribbon cartridge. You can choose from a wide range of single-color ribbons.
- Drop in a media cartridge. You can choose media in widths that range from 0.5 in. to 4 in. (12.7 mm to 101.6 mm), and come in many colors, styles, and materials.
- Type your text and insert objects or symbols of your choice; or choose a preformatted layout design.

Material and ribbons from **Brady Corporation** are programmed with the ability to communicate with the printer and software. This allows you to gain the full benefit of the system,

Features and Functions

The following are just some of the features that make this system so easy to use and ready to meet your label-making requirements:

- Small, lightweight (approximately 15 lbs [6.8 kg]) unit, ready for your desktop.
- Color touch screen LCD display, plus keyboard input for ease of use.
- Pre-designed layouts for many standard-use label applications.
- Hundreds of graphics for inclusion on your labels.
- Single-color job printing at 300 DPI, up to 4 in. (101.6 mm) wide and up to 9.8 ft. (3 m) long.
- Wide variety of ribbon colors.
- Easy loading label and ribbon supplies.
- Continuous and die-cut label supplies in a variety of high-performance materials.
- Transfer graphics from PC or USB flash drive. Supported graphic formats are Windows metafile (*.wmf) and Bitmap (*.bmp).
- Print labels from PC.
- Automatic cutter.

Compatible Applications

The **BBP™31 Sign & Label Printer** is compatible with the following software applications (when connected to a PC):

- **LOCKOUT-PRO™** Graphical Procedure Writing Software
- **CHEMLABEL™** Software
- **NetDoc** Cable Management Software System
- **MarkWare™** *Tape and Label Software*
- **MarkWare™ EXPRESS** *Facility Identification Software*

When used with one of these software packages, the printer will automatically recognize all enabled and compatible materials up to 4 in. (101.6 mm) wide. For operation of the printer with other software, refer to the documentation for your application.

Note: Only BBP31™ supplies will work with this printer.

System Specifications

- **Weight:** 15 lbs (6.8 kg)
- **Dimensions** (stored): 8.9 in. x 12.0 in. x 9.5 in. (22.6 cm x 30.5 cm x 24.1 cm)
- **Operating Temperature:** 50 - 104°F (10-40°C)
- **Relative Humidity:** 10% to 80% RH non-condensing
- **Storage:** -4 to 122°F (-20 to 50°C) at 15% to 90% RH non-condensing
- **Voltage:** 90 to 264 VAC, 47 to 63 Hz
- **Print Resolution:** 11.8 dot/mm, 300 dpi
- **Output media size:** 0.5 in. to 4 in. (12.7 mm to 101.6 mm)
- **Maximum label length** (continuous media): 9.8 ft (3 m)

Keyboard Configurations

Your keyboard configuration depends on the region where you do business. The following are the currently supported keyboard configurations.

There are five keypad configurations available for the **BBP™31 Sign & Label Printer**. The keypad layouts and the language supported by each are as follows:

Keyboard Type	Language Applied
Americas QWERTY	North American Spanish, French Canadian, Portuguese, English
QWERTY	English, Danish, Finnish, Italian, Dutch, Norwegian, Polish, Portuguese, Romanian, Spanish, Swedish
AZERTY	English, French, Dutch
QWERTZ	English, Czech, German, Hungarian, Slovakian, Slovenian, French, Italian
Cyrillic	English, Bulgarian, Russian
Asia	English, Simplified Chinese, Traditional Chinese, Japanese, Korean



See *“Typing Text and Accented Characters”* on page 4-16 for instructions on how to access all of the keyboard characters.

About Menus, Dialog Boxes and Screens

The following information describes the menus, dialog boxes and screens used in the **BBP™31 Sign & Label Printer** system.

Home Page

The *Home* page automatically displays when you first start the printer. The main sections of the *Home* page are:

Item #	Icon	Description
1	Status Bar	Shows the current label size and indicators for the amount of media and ribbon remaining.
2	Tools Panel	Depending on the option selected, provides buttons for Object Sizing, Delete, Undo, Zoom In/Out, and Help.
3	Editor	Text or object entry area. Type, touch or select objects to display and edit in this area. Shows color of installed media and ribbon.
4		Home: Returns you to the <i>Home</i> page from anywhere in the application. Button is greyed out on the <i>Home</i> page.
5		Menu: Displays File, Label and System options.
6		Print: Displays the <i>Print</i> dialog box where you can choose options for printing the current label. Not available unless an object is in the <i>Editor</i> .
7	Control Panel	Primary area for selecting all of your options for creating, editing and working with labels and objects. The panel changes depending on what option is selected.



Tools Panel

The *Tools* panel contains options for editing a label. If no label is selected, the panel contains only the Help button.

Undo is available only when there is an operation to undo. Delete and Size are available only when you have an object selected. Help, Zoom In and Zoom Out buttons are always available.



The Tools panel contains the following options:

Icon	Description
	Delete: Deletes the selected object (text, barcode or graphic).
	Undo: Lets you undo a limited number of actions. If there is no undo action available, the undo button is greyed out. There is no redo option available.
	Size: Toggles the display of sizing handles so you can change the size or rotation of the selected object.
	Help: Context sensitive help that displays information about the selected item or area on the menu. See the <i>User's Manual</i> for additional information about Help topics.
	Zoom In: Lets you increase the view of the object(s) on the label. Scroll arrows appear if the objects are zoomed larger than the available display area.
	Zoom Out: Lets you decrease the view of the object(s) on the label.

Menu

To display menu options:

1. Touch **Menu** to display the menu options.
2. Choose from the following areas:
 - **File:** Create new file, open existing file, save a file or delete a file.
 - **Label:** Change the size and orientation, add a frame around the label, or choose a template.
 - **System:** Set up the printer, view printer information (e.g., software version), import data, or get more tools.
 - **Help:** Displays help for the options listed on the menu.
 - **Home/Start Over:** Returns you to the *Home* page.
 - **Cancel:** Cancels the current action and returns you to the previous location.



Control Panel

The Control Panel provides options specific to the object selected or the function being performed.

Home Page Control Panel

From the *Home* page, the control panel provides options for selecting available label types (e.g., Pipe Markers, Right-to-Know, etc.). These label types provide a starting point for creating your label. Depending on the label type you select, the options for populating the objects will vary.



Add Object Panel

The *Add Object* control panel provides options for adding additional objects (e.g., text, graphic, etc.). Once selected, the options available for that object type display. This control panel is accessed when you press *Add Object* from other panels, touching a blank part of the label or touching the home screen label area.

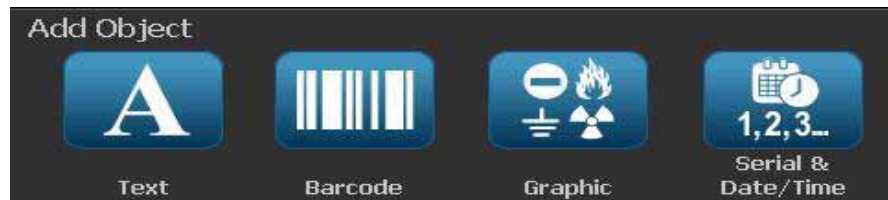

With an Object Selected





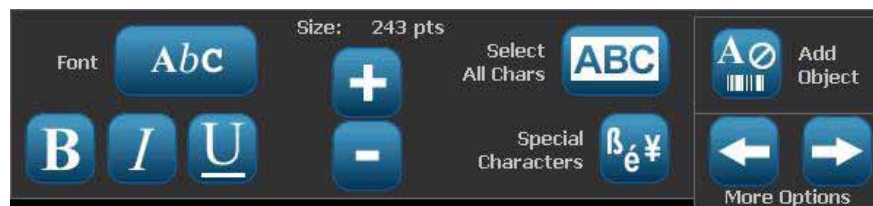

With an object selected, the control panel provides options for editing the object. From this panel, you can also add more objects or see more editing options. The panel changes depending on the type of object selected.

The following example shows one of the text-editing panels. Pressing one of the options in the panel either immediately changes the option or provides additional options that you can select.



Button Actions

These button actions are used throughout the system. Unless necessary, button actions are assumed to be understood and are not included in the procedures.

- **Help** : Available at any time by touching the help button. You can also access the user guide from the product CD that comes with the printer.
- **Home** : Select from anywhere in the application to return to the *Home* page. You may be prompted to save your current label file.
- **Cancel** : In most cases, you can press Cancel at any time to return to the previous screen without making any changes.
- **Zoom**: Touch  to zoom in or  to zoom out. Applies to *labels*, not objects.
- **More Options** : Used throughout the system and lets you choose from additional options that are available for the currently-selected object.
 - **Fonts**: Choose a font type.
 - **Text Features**: Choose one of the text options.
 - **Label Alignment**: Align an object on a label.
 - **Object Framing**: Place a frame around an object.
- **Scroll Arrows**: Display whenever there are more items than can be shown on a screen or menu. There are two types of scroll arrows:



- **Up or Down** : Use to move through a list of items in a menu.











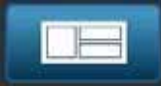

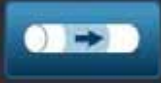
- **Navigation** : Use to view all parts of a label.

Available Label Types

From the Home page, you can access all of the available label types. You can see all available label types by pressing **More Label Types** .

Note: Not all label types will be available with all configurations.

Icon	Description
	General Templates: Templates for creating commonly-used label types.
	Custom Label: Lets you create a label without a template.
	Pipe Markers: Standard or roll-form pipe markers and symbol and arrow-tape pipe markers.
	Right To Know (RTK): OSHA (Occupational Safety and Health Administration) compliant chemical warning labels.
	CLP [GHS] Globally Harmonized System: Compliant chemical warning labels for use in Europe. Classification and Labeling intended to minimize physical, health and environmental risks associated with chemicals during transport, storage, use and disposal. These templates are installed for European regions only.
	Arc Flash: Product Safety Signs and Labels for implementing compliant labels appropriate for work practices that are required to safeguard workers from injury while working on or near exposed electrical parts that could become energized.
	QuickLabel: Specialty labels that let you select from a list of predefined labels.
	WHMIS: (Workplace Hazardous Materials Information system). Canada's national hazard communication program for hazardous workplace chemicals of controlled products and hazardous materials.
	HSID: (Hazardous Substances Identification). Compliant chemical warning labels for use in Europe. These templates are installed for European regions only.
	Customize: Lets you determine which three (default) label types will display on the Home page.

2 Setting up Your Printer

Unpacking and Setting up Printer

Carefully unpack and inspect the printer surfaces (interior and exterior) and the labeling system for possible damage during shipping.

Note: Be sure to remove any transportation protection from around the printhead and inside the enclosure cover.

What's in the Box

- **BBP™31 Sign & Label Printer**
- Documentation CD including: electronic Quick Start Guide, electronic User's Manual and web links
- Printer Driver CD
- Power Cord
- USB Type B Cable
- Printed "Quick Start Guide"
- Cleaning Kit

Note: Please keep the original packaging, including the box, in case the printer must be returned.

System Components



Figure 2-1. Printer Components

- | | |
|-----------------|------------------------------|
| 1 Stylus | 2 Display (with touchscreen) |
| 3 Power Button | 4 Enclosure Cover |
| 5 Label Exit | 6 Media Wiper |
| 7 Media Guides | 8 Media |
| 9 Cutter | 10 Ribbon Cartridge |
| 11 Ribbon Cover | 12 USB and Expansion Ports |
| 13 Keyboard | |

Note: The printer is equipped with a universal power supply and can be operated with a supply voltage of 100 to 240 V~, 50- to 60 Hz. The printer senses the voltage type and automatically adjusts for the power source.

Setting up the Printer

Connect Printer Power

To setup the printer:

1. Plug the power cord into the printer at the location shown.
2. Plug the other end of the power cord into an AC power outlet. The printer automatically comes on and displays the primary Home Page. The size and color of the currently installed media and other status indicators are shown.

Note: If there is no ribbon or media installed, the system defaults to black ribbon and 4 in. [101.6 mm] wide continuous white media.



Install or Change Supplies

The media and ribbon supply cartridges use a “smart cell” to define and track the supply information. The system automatically recognizes the supply information for the installed media and ribbon.

Note: The printer can be either on or off when changing supplies.

To install or change ribbon:

1. To remove ribbon, open the enclosure cover (opens from left).



2. Release the latch on the ribbon cover [2] and swing open.
3. Release the ribbon cartridge latch [3] and lift the ribbon cartridge up and out.

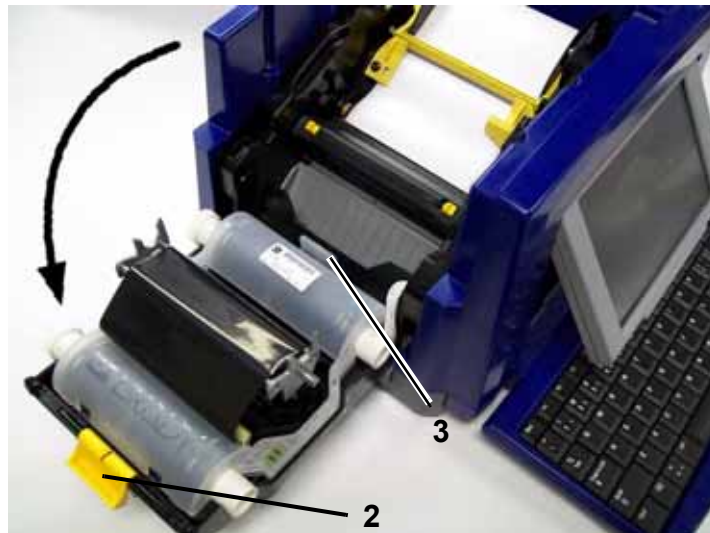

4. Place ribbon cartridge with ribbon over print head (product label toward machine), then snap into place.



5. Close and latch the ribbon cover.
6. Close the enclosure cover.
7. If printer was off, press . The system detects the installed supplies, sets media and ribbon colors, indicates the label dimensions and the amount of remaining supplies.

Unpacking and Setting up Printer

Setting up the Printer

To install or change media:

1. Open the enclosure cover (opens from left).





2. Release the latch on the ribbon-cover [2] and swing ribbon cartridge open.

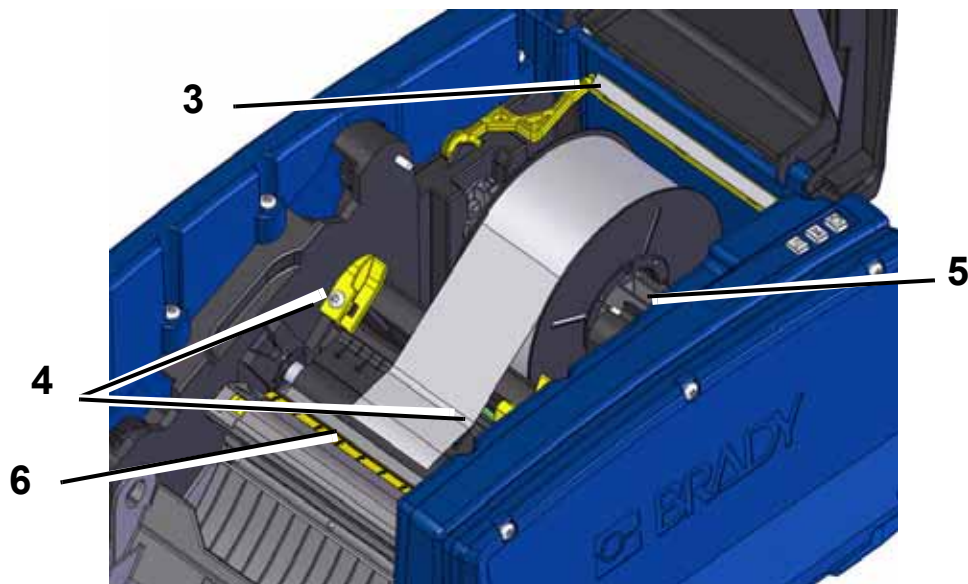

3. Swing yellow media wiper [3] to far right (when facing display), if engaged.
4. Slide yellow media guides [4] to full-open.
5. Remove existing media, if installed, by pulling cartridge from printer. Media unwinds from the top of the roll.
6. Insert media cartridge until spindle ends rest in slots of media holder [5].
7. Feed media from top of roll until it sits on top of black rubber roller ~.25 in. (6.35 mm) from cutter entrance.
8. Close media guides until they touch edge of media liner with media under the guides.
9. Move media wiper into position so it rests on media.

Note: Not all media requires the use of the media wiper. Engage the media wiper only if needed for the supply installed.



10. Close and latch ribbon cover, then close enclosure cover.
11. If printer was off, press . The system detects the installed supplies, sets background and foreground colors, indicates the label dimensions and the amount of remaining supplies.

Feeding and Cutting Label Stock

Use this procedure to advance the media to the cut position, and (optionally) cut the media.

To feed and/or cut label stock:

1. With the printer power on, press and hold **Feed**  until the length of media you want exits the printer.

Note: For die-cut media, the media is advanced to the cut position which is the next die-cut label. For continue media, the media advances until you release the Feed button.

2. If desired, press **Cut** . The printer will cut off the media.

System Power

Starting Printer from a Non-powered (Cold) State

This procedure describes the power-up sequence when starting from a non-powered state (i.e., printer has been unplugged). The printer does **not** retain the label during a power interruption.

Note: With power removed (i.e., printer disconnected from power source), the system clock retains its settings for about 30 days.

To start the printer from a cold state:

1. Plug the printer into a power source. The system automatically recognizes the supply information for the installed media and ribbon and opens to the *Home Page*.
2. On the *Home page*, continue with your label activities.

Waking the Printer from Sleep Mode

If you do not touch the screen or press any keyboard or other keys/buttons for a defined period of time, the system turns off the display and goes into a low-power consumption mode (see “*Set Clock*” on page 2-15 for details). The current label and settings are retained.

To wake the printer from sleep mode:

1. Press  or touch the screen. The *Editor* displays the label or menu you were on when the printer went to sleep.
2. Continue with your label activities.

Note: If a label is defined when the system goes into sleep mode and the media is changed to a supply where the label no longer fits, you will be prompted to make the data fit or save the existing label before continuing. If you choose the option to make the data fit, the system will move and/or resize the objects so they fit on the new media size.

Powering Off the Printer

When the system is shut down, the display turns off and the system goes into a low power consumption state but does not require a cold start to turn back on. In this state, you can either touch the screen or press the power button to return the system to the same state it was in before going into lower power consumption mode.

Note: To completely shut down the printer, you must disconnect the system from the power source.

To turn off printer power:

1. With the printer on, press .
2. If there are unsaved changes in the currently active file, you will be prompted to save the current label file:
 - To power off without saving the current label file, press **No**.
 - To save the current label file, press **Yes**. See “Save a Label File” on page 6-1 for further instructions.

Resetting the Printer

Use this procedure to reset the printer (e.g., if the screen freezes).

To reset the printer:

1. Press and hold  for at least 5 seconds. The system performs the initialization process and starts the printer. Any data in the *Editor* at the time of the reset will be lost.
2. When the *Home* page displays, you can continue with your label activities.

Creating Your First Label

Creating your first label on the **BBP™31 Sign & Label Printer** is as easy as starting to type! You don't need special software and you don't have to be connected to a PC to create or print labels.

This procedure describes how to create a text label with minimal formatting, using basic editing techniques, and printing the label.

Note: Take advantage of the powerful label creation and editing capabilities by using the pre-designed layouts, templates and graphics included with the **BBP™31 Sign & Label Printer**. See the procedures in this manual for detailed instructions.

To create a text-only label:

1. From the *Home* page, start typing.
2. To create another line in your text object, press **Enter**.
3. To change the look of your text, you can select any of the available font or text attributes that display in the *Control Panel* as soon as you start typing.



To print your label:

1. When you are done creating your label, select **Print** .

Note: The printer must have ribbon and tape installed before you can print.

2. In the *Print* dialog box, type the number of copies you want to print.



3. Press **Start Print** .

Using Your Printer with a PC

You can use a personal computer to install software upgrades, or to create labels on the PC rather than working directly on the printer.

Note: You must have labeling software installed on your computer to create, edit or print labels from the PC. Refer to your labeling software documentation for instructions about installing and using the software. See “*Compatible Applications*” on page 1-2 for more details.

Installing USB Driver

If you are connecting the BBP31™ printer to your PC, you will need the USB device driver installed on your PC. Once connected, the PC should automatically detect and install the USB driver, if it is not already installed.

1. Attach the small end of the USB cable to the printer, then the flat end of the cable to the PC.
2. Turn the printer on. On the PC, “*Found New Hardware*” pops up in the lower right corner of the screen and the print driver wizard is launched.
3. In the *Wizard*, click **Install the software automatically** (if it is not already selected).
4. Click **Next**. The print driver installs. This takes a minute or two.
5. When complete, in the *Wizard*, click **Finish**.

The **BBP™31** printer is now available to receive information from your computer labeling program.

When printing from the PC, the printer must be attached to the PC via the USB cable. Be sure to select the **BBP™31** printer in the print dialog box of the PC labeling program you are using.



Creating and Printing Labels from a PC

1. Connect the USB cable from the printer to any available USB port on the PC.
2. From your labeling software, print your labels to the **BBP™31** printer.



Note: You cannot save labels or templates from the PC to the printer.

Setting up the System Defaults

The System Setup function is used to set the printer default settings. Default values are common settings that are pre-assigned to make the system usable as soon as power is applied (e.g., date and time are set to your local date and time). By changing the defaults, you can set the settings to your specific requirements.

To change setup functions use the following procedures. Any defaults set here will stay in effect even when power is removed from the printer, and during upgrades.

To change system default settings:

1. Select **Menu** .
2. In the menu list, select **Setup** . The Setup menu displays.
3. From the *Setup* menu, choose any option(s) to change the system configuration:

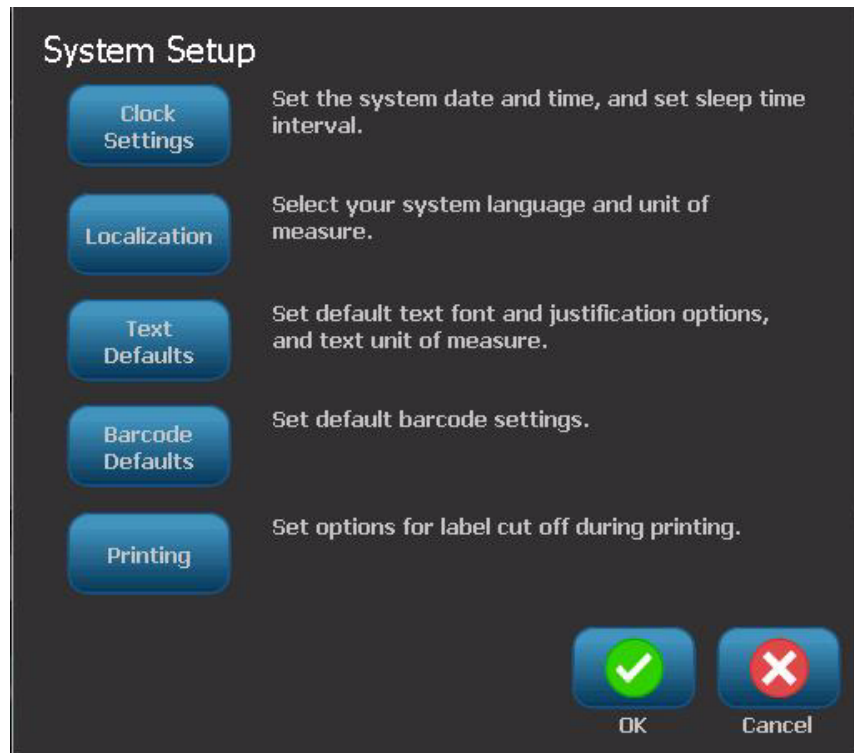





Setting up the System Defaults

Creating and Printing Labels from a PC

Set Clock

To set date, time and sleep mode:

Note: With power removed (i.e., printer disconnected from power source), the system clock retains its settings for about 30 days.

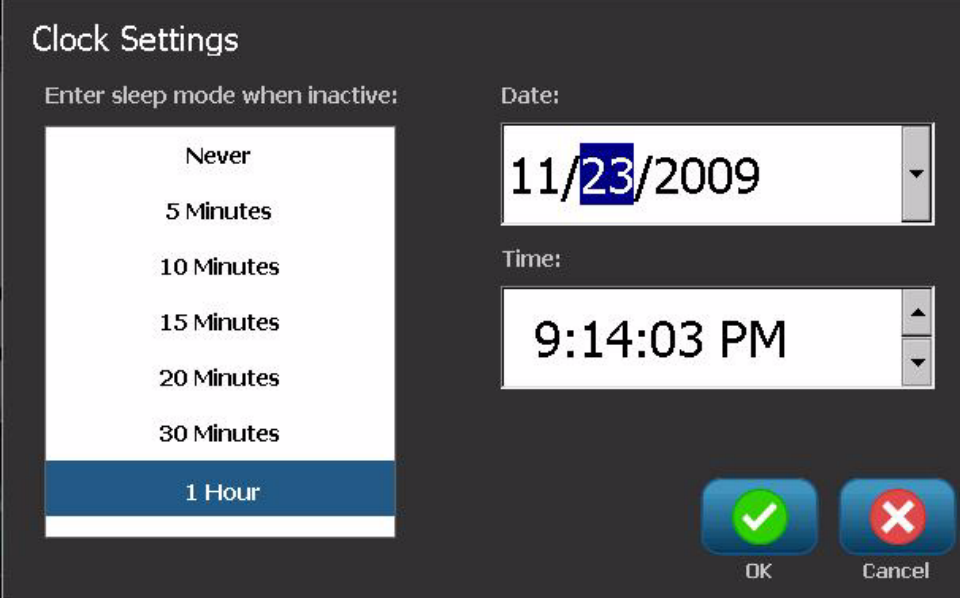

1. Select **Menu** .
2. In the menu list, select **Setup** .
3. In the *Setup* menu, select **Clock Settings** .
4. In the *Clock Settings* popup, change any of the following options (this also sets the system clock, which is needed if you want a time stamp on your label):
 - **Sleep mode timeout:** Choose the amount of time you want the system to wait before entering sleep mode.
 - **Date:** Touch to highlight the *Month*, *Day* or *Year*, then touch the ▼ arrow to choose from the calendar display.
 - **Time:** Touch to highlight the *Hour*, *Minute* or *Second*, then touch the ▲ or ▼ arrows to change the time. Touch *AM/PM* to toggle between AM and PM.
5. When done, select **OK** .



The screenshot shows the 'Clock Settings' popup menu. On the left, under 'Enter sleep mode when inactive:', there is a list of options: Never, 5 Minutes, 10 Minutes, 15 Minutes, 20 Minutes, 30 Minutes, and 1 Hour. The '1 Hour' option is highlighted with a blue bar. On the right, under 'Date:', there is a date field showing '11/23/2009' with a dropdown arrow. Below that, under 'Time:', there is a time field showing '9:14:03 PM' with up and down arrows. At the bottom right, there are two buttons: 'OK' with a green checkmark icon and 'Cancel' with a red X icon.

Localization and Unit of Measure

To choose a language and unit of measure:

1. Select **Menu**.
2. In the menu list, select **Setup** .
3. From the *Setup* menu, select **Localization** .
4. In the *Language* list, choose the language you want the system to display.
5. Select a **Unit of measure** (Inches vs. Millimeters).
6. When done, select **OK** .

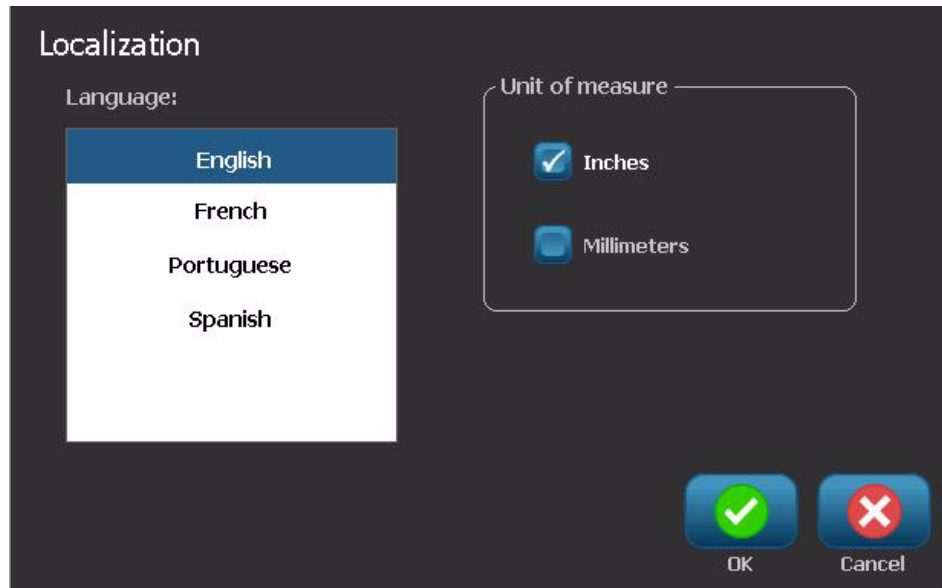



Setting up the System Defaults

Creating and Printing Labels from a PC

Set Text Defaults

To set the text defaults:

1. Select **Menu** .
2. In the menu list, select **Setup** .
3. In the *Setup* menu, select **Text Defaults** .
4. In the *Text Defaults* menu, change any of the following options:

Note: Text/object options take effect with the next text object created. Existing text objects are not affected.



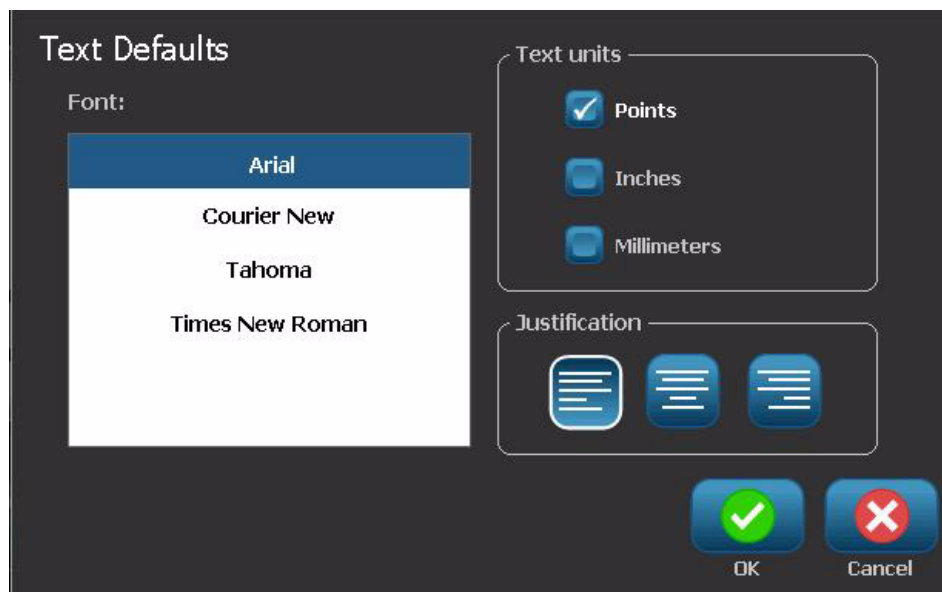

- **Font**
- **Text units**
- **Justification**

5. When done, press **OK** .



Set Barcode Defaults



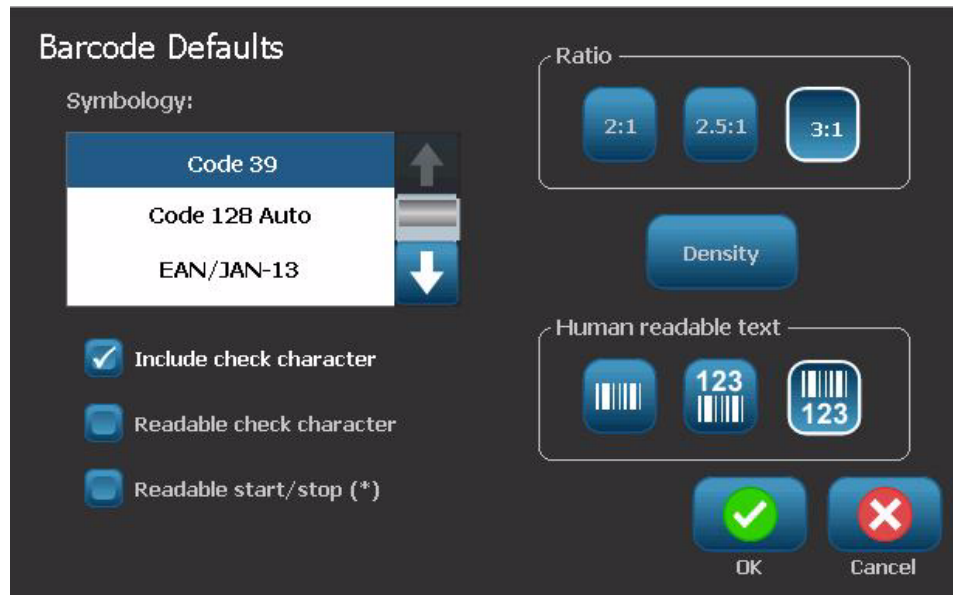

To set the barcode defaults:

1. Select **Menu** .
2. In the menu list, select **Setup** .
3. In the *Setup* menu, select **Barcode Defaults** .
4. In the *Barcode Defaults* menu, change any of the following options:
 - **Symbology**
 - **Check Characters**
 - **Ratio**
 - **Density**
 - **Human readable text**
5. When done, select **OK** .



Set Printing

To set the printing defaults:

1. Select **Menu** .
2. In the menu list, select **Setup** .
3. Select **Printing** .
4. In the *Printing* dialog, change the **Auto cut settings** to your desired options.
5. When done, select **OK** .

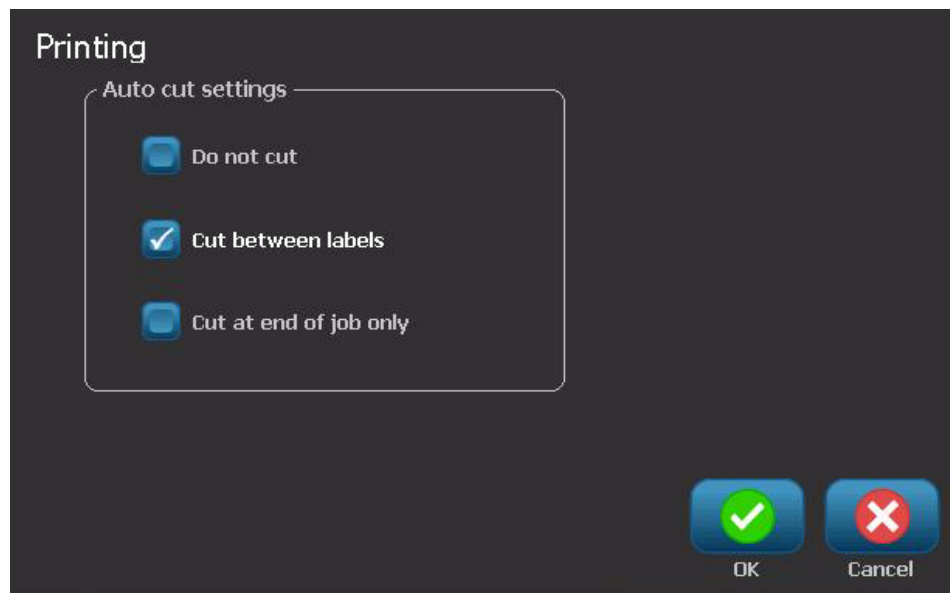



Customizing Home Page Defaults



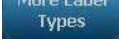

You can choose which three label types to display on your Home page. The selected label types will be set as the default on your printer.

The *Preview* area will immediately reflect the changes.

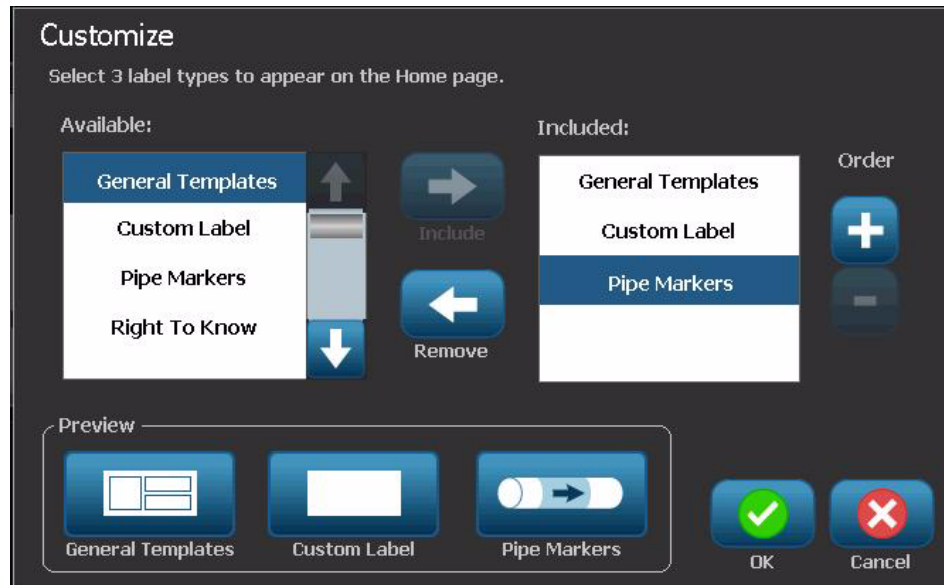
To select label type defaults:

1. From the *Home* page, select **More Label Types** .
2. From the *Label Types* dialog, select **Customize** . The *Customize* dialog box opens.



3. From the *Included* list, select a label type you do not want displayed, then select **Remove** .
4. From the *Available* list, select a label type to include and then select **Include** .
5. If desired, change the display order by pressing **Order** .
6. When done, select **OK** .

Displaying System Information

Creating and Printing Labels from a PC

Displaying System Information

Use this procedure to view additional information about the system, such as the current software or firmware version and the available memory.

To view system information:

1. From the *Editor*, select **Menu** .
2. In the menu options list, select **Info** . The *System Information* dialog box displays.

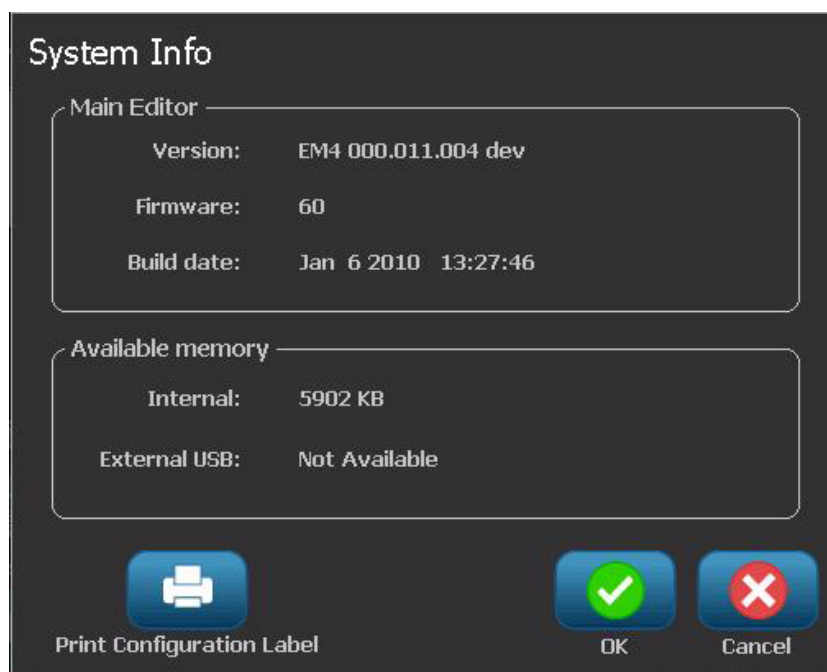

3. Select **OK**  when you are done viewing the system information.

Note: Select **Cancel** at any time to cancel the operation and return to the *Editor*.

3 Working with Labels

Create Labels

Creating a Label from a Template

Use this procedure to create a label using a general template or specialty template.

To create a label from a general template:

1. From the *Home* page, select **General Templates** .
2. On the *Select Template* dialog box, select a **Category**.

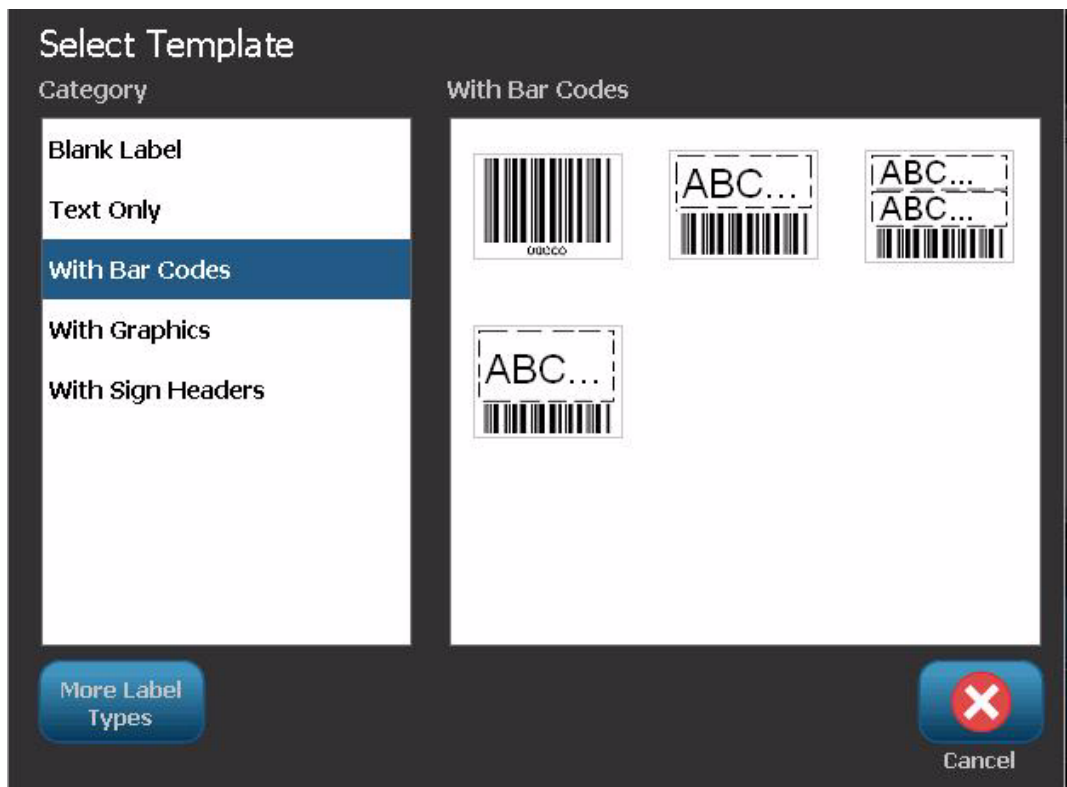



Create Labels

Creating a Label from a Template

3. Choose a template from the list of available templates. The label is displayed in the *Editor* with the objects scaled to fit the installed media.
4. To choose a different template, select **Change Template**  .

Notes:

- Once you have defined data for at least one of the objects, the option to change the template is no longer available.
 - If there are unsaved changes in the currently active file, the system will prompt you to save the file before continuing.
-

5. In the *Editor*, select an object using one of these methods:
 - **Screen:** Touch the object.
 - **Keyboard:** Press **Tab** key to move to the next object.
 - **Buttons:** Select **Next Object**  (only available if there are undefined placeholder objects).
6. **To enter text**, select a text object and start typing. You can change the look of your text by selecting any of the available font or text attributes that display in the *Control Panel* as soon as you start typing
7. **To change a barcode**, touch the barcode object and change any of the options in the *Barcode* dialog box.
8. **To change a graphic**, touch the graphic object and choose from any of the available graphics in the *Select Graphic* dialog box.
9. **To add an object**, select **Add Object**  (if available) and choose from any of the available object types.

Note: You can only add more objects to the label if all template objects have been defined.

10. Continue selecting objects and entering data until all objects are defined.

Creating a Custom Label

Use this procedure to create a label without using a predefined template. You can add objects to a label by touching a blank area in the *Editor*, or by using the *Add Object* button.

To create a custom label by touching the Editor:

1. On any screen, touch a blank area in the *Editor* to add an object.
2. In the *Add Object* control panel, choose an object type. The available options for the selected object will display.

Note: When in the *Add Object* panel, you can also touch an empty area of the label to create a placeholder object at that location. The object type you create will then insert into the placeholder object.

3. To add another object, touch a blank area in the *Editor*, then choose the object type you want to add.

To create a custom label using Add Object button:

You can also add an object by using the *Add Object* button when it is available on the control panel.

1. From any screen, select **Add Object**  to add an object to the label.
2. In the *Add Object* menu, press a button to add an available object type.



Note: The object is placed on the label at a default size and position that varies depending on the dimensions of the label.

3. To add another object, select **Add Object**  again, or touch a blank area on the label, then choose the object type you want to add.

Note: If the label is full and there is no place to add a new object, the object will be placed at the right-most edge of the label and you will have to move and/or resize it.

Note: See “Specialty Label Types” on page C-1 for creating other label types.



Set Label Attributes

Creating Fixed-Length Label

Use this procedure to create a label where the continuous-media label length is set, not variable. Once selected, the printable area shown on the label is reduced by the amount of the leader/trailer required for the installed supply, so that the total label length output matches the selected length.

Note: The label size for die-cut media is already set and cannot be adjusted.

To create a fixed-length label:

1. From the *Home* page, select **Menu** .
2. In the menu list, select **Size & Orientation** .

Note: You can also access the *Label Size & Orientation* box by touching the **Label Size** text at the bottom of the screen.



3. On the *Label Size & Orientation* dialog box, select **Fixed Length** .
4. In the *Length* field, enter the desired label length.

Note: Minimum supported length is 0.5 in. (12.7 mm). Maximum supported length is 120 in. (3048 mm).





5. Select **OK**. The *Status Bar* indicates the new label length.

Creating Auto-Sized Label

Use this procedure to create a label where the continuous-media label length adjusts to fit the data that you add to the label (variable label length).

Note: The label size for die-cut media is already set and cannot be adjusted.

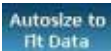
To create an auto-sized label:

1. From the *Home* page, select **Menu** .
2. In the menu list, select **Size & Orientation** .
3. Select **Autosize to Fit Data** . When entering data, the label size will automatically be adjusted to fit the data.
4. Select **OK** .

Orientation

Use this procedure to set the label in either portrait or landscape orientation. You can change the label orientation even if you are working on a label in the *Editor*.

To set the label orientation:

1. Select **Menu** .
2. In the menu list, select **Size & Orientation** .
3. In the *Label Options* dialog box, select one of the orientation buttons to choose the orientation of your label:
 - **Portrait** : Length from top to bottom.
 - **Landscape** : Length from left to right.

Note: If the current data will not fit on the selected length, you will be prompted to have the system make the data fit, or cancel the change. If you choose to make the data fit, the objects will be moved and/or resized so they fit on the label; however, the objects will **not** be rearranged into a new orientation.

4. Select **OK** .

Framing a Label



Note: When printing with frames around the labels, be sure the media guides fit snug against the media so the tape does not shift while printing. For making fine adjustments to the frame, see “Adjusting Print Offset” on page 5-8.

Use this procedure if you want to place a frame (border) around the **entire** label. The following conditions apply:

- **Fixed-size labels:** When using continuous or die-cut supplies, the frame is applied to the *outer* perimeter of the printable area. If changed, the frame size changes with the label size.
- **Auto-sized labels:** When objects determine the label length, the frame is sized to fit the objects on the label *when the frame is applied*. If the label size changes after that, the frame is **not** resized. You must reapply the frame to the label after making a size change.

To place a frame around the label:

Note: If you are not working with a fixed-length label, you must have at least one object on your label before you can place a frame around the label.

1. Select **Menu** .
2. In the menu list, select **Frame** .
3. From the *Label Frame* menu:
 - a. Select the frame shape (none, rectangle, rounded rectangle).
 - b. Select the frame line width (narrow, medium, wide).

Note: Line width options are available *only* when the rectangle or rounded rectangle frame shape is selected.





4. When your changes are complete, select **OK** . The changes are applied.



Tools

Zooming the Label View

To zoom a label view:

1. Touch  to zoom in or  to zoom out.
2. Touch the zoom control again, as necessary, until you reach the desired zoom level.

Note: If all of the label objects cannot be displayed on the screen, the scroll arrows display. See “Scrolling the Label View” on page 3-7 for details.

3. Touch   as needed to return to normal viewing mode.

Scrolling the Label View

Use this procedure to view part of the label that is no longer displayed on the screen, either vertically or horizontally, without changing the zoom level.

To view hidden parts of a label:

1. When one or more scroll arrows appear in the *Editor*, touch a scroll arrow to scroll in the direction you want to view. The ruler value updates automatically as the label view changes.



Note: If the entire label is shown on the display, no scroll arrows appear.

2. Touch the scroll arrow again to continue scrolling in the direction you want. If you hold the scroll arrow down, the system will continue scrolling.
3. To return to normal viewing mode, touch  until you can see the entire label content.

4 Working with Objects

Overview

What is an Object?

An object can be any text, graphic or barcode element on a label. Objects can be edited, moved, aligned, deleted, rotated, framed and/or sized. Some objects also have characteristics that can be added or changed (e.g., bold, justified, underlined, density).

Object Types

Object types include Text, Graphics, Barcodes, Serialization, and Date/Time. To add objects:

- **Touch the *Editor* screen:** Inserts a placeholder object which you can then populate with any of the object types.
- **Touch Add Object button** (located in the *Control Panel*): Inserts a placeholder object which you can then populate with any of the object types.
- **Add Empty Object** (when at the *Add Object* panel): Touching an empty area of the label will create a placeholder object at the location you touched. The object type you create will then insert into the placeholder object.

Undo

Undo allows you to restore the last editing operation(s) that have taken place. For example, if a segment of text has been deleted or changed, performing an undo will restore the original text.

The number of undo actions are limited and are based on the complexity of the label and the specific objects on the label. Typically, the fewer objects on the label, the more undo actions can be done. If you take an action that you cannot undo, the Undo option will no longer be available.

Actions that you can undo are:

- Add object
- Format objects or change object attributes
- Delete objects
- Size or move objects
- Type text

Actions that you cannot undo are:

- Any file operation (save, open, delete)
- Change printer defaults
- Print/cut operations
- Select a label template

To undo an action:

1. Select **Undo** . The last action is canceled and the label returns to its previous state.
2. Repeat *Step 1* to undo multiple actions.

Object Sizing

The system automatically reduces the object size to fit on the label and will move or resize the object so it stays within the printable area of the label (text will not be truncated).

Adding Objects

The easiest way to add an object is to touch a blank area of the *Editor*. If you are currently editing an object, touch the screen twice, once to deselect the current object and once to insert a new object.

You can also add objects using any of the following the methods.

Text Objects

To add a text object:



1. Use one of the following methods to add a text object:
 - **Start typing:** A text box is added and filled with the typed text. If there are already placeholder objects in the *Editor*, the text will be added to the first available (empty) placeholder.
 - **Touch a blank area of the screen:** A text box is added and any typed text will be added to that object.
 - **Select Add Object:** Select **Text** . A text box is added and typed text will be added to that object.

Note: As soon as a text object is selected, the system goes to the text editing panel and you can type and/or edit the text.

2. To edit the text, see “*Working with Text*” on page 4-10.

Graphic Objects

To add a graphic object:

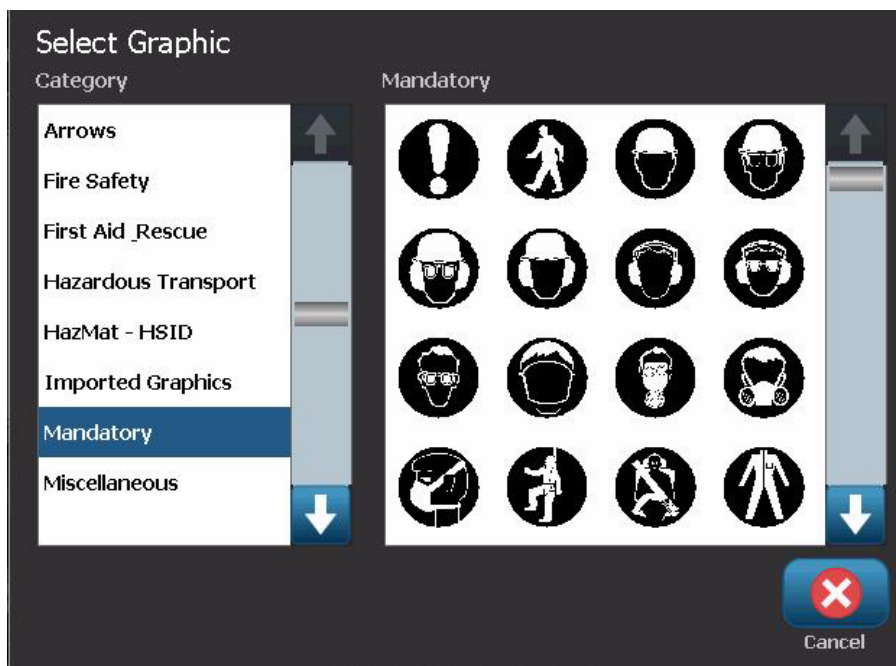

1. Use one of the following methods to add a graphics object:
 - Touch anywhere in the *Editor*.
 - or -
 - If you are already in a label, select **Add Object** .
2. In the *Add Object* panel, select **Graphic** .
3. In the *Select Graphics* dialog box, choose the **Category** for the graphic you want to add.
4. Touch the desired graphic. The graphic is added to the label (or replaces the selected graphic placeholder).



Note: You can also import your own graphics and use them like the graphics included in the system. See *“Import Graphics”* on page 7-1.

Barcode Objects

To add a barcode object:

1. Use one of the following methods to add a barcode object:
 - Touch anywhere in the *Editor*.
 - or -
 - If you are already in a label, select **Add Object** .
2. In the *Add Object* panel, select **Barcode** .
3. In the *Barcode Content* dialog box:
 - a. Select a barcode **Symbology**.
 - b. Type a **Data Value**.

Note: You can set a different symbology as the default by using *System Setup* (see “*Set Barcode Defaults*” on page 2-18).

Note: To set a different data source, see “*Converting Text or Barcode to Variable Data*” on page 4-31.

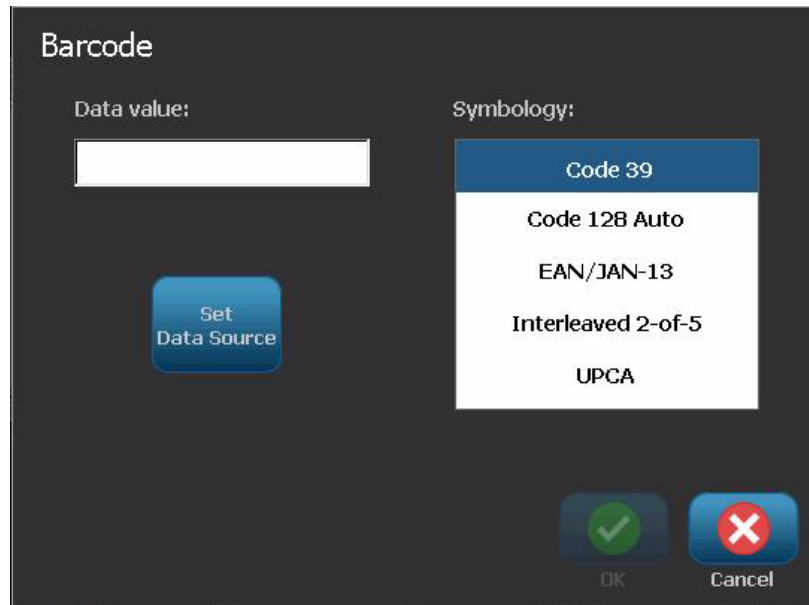

Note: If a typed character is invalid for the active symbology, a message will display indicating that you have entered an incorrect character. Options for entering barcode data and selecting symbology will remain displayed until valid characters are entered or you cancel the operation.



4. Select **OK** .

Serial Objects

Serialization lets you create labels that contain number or letter sequences that print as multiple labels at print time.

Note: This procedure applies only when **not** using a template. If using a template, see “*Converting Text or Barcode to Variable Data*” on page 4-31.

To add a serial object:

1. Use one of the following methods to add a barcode object:
 - Touch anywhere in the *Editor*.
 - or -
 - If you are already in a label, select **Add Object** .
2. In the *Add Object* panel, select **Serial & Date/Time** .
3. In the *Serial & Date/Time* dialog box, select either:
 - **Serial Text**
 - **Serial Barcode**

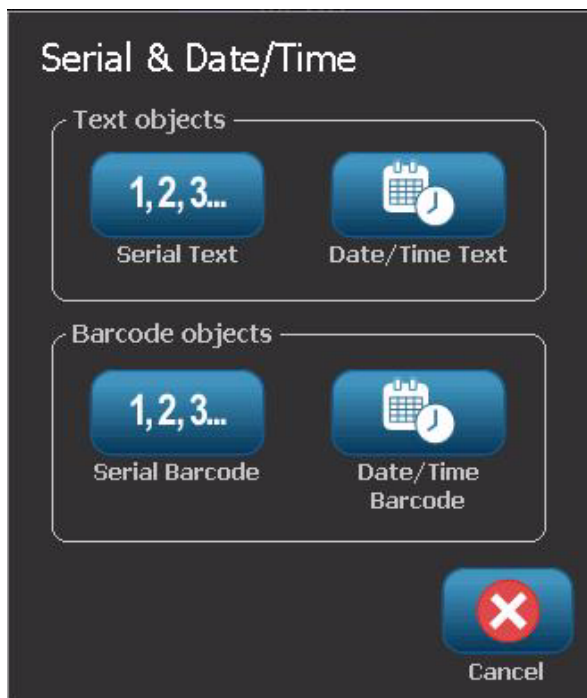

4. In the *Serial* dialog box, type or select values for setting the serial attributes (the *Sample* area will immediately display an example of the selections):
 - **Starting Value:** Starting label value for the serialization to begin. Can use alpha or numeric (positive or negative) values.
 - **Ending Value:** Ending label value for the serialization to stop (not used if Total Number of labels is entered). Can use alpha or numeric (positive or negative) values.
 - **Change by:** Number that the serial value increments or decrements for each label. Can use positive or negative values.
 - **Total number:** Number of labels that will be printed (not used if Ending Value is entered).
 - **Before serial:** Prefix (text or spaces) before the serial value.
 - **After serial:** Suffix (text or spaces) after the serial value.

5. When done, select **OK** . The system displays the initial (first) value of the serialization on the label.



Date/Time Objects

The Date/Time option lets you place a time stamp on your label (text or barcode). Depending on the options you choose, you can add a date, time or date *and* time.

You can change the clock settings at any time by selecting **Clock Settings** (see “Set Clock” on page 2-15, starting at Step 4 for more details).

Note: With power removed (i.e., printer disconnected from power source), the system clock retains its settings for about 30 days.

To add a date/time object:

1. To add a date/time object:
 - Touch anywhere in the *Editor*.
 - or -
 - If you are already in a label, select **Add Object** .
2. In the *Add Objects* panel, select **Serial & Date/Time** .
3. In the *Serial & Date/Time* dialog box, select:
 - **Date/Time Text:** Places a date/time object on your label.
 - **Date/Time Barcode:** Places a barcode object with date/time data.

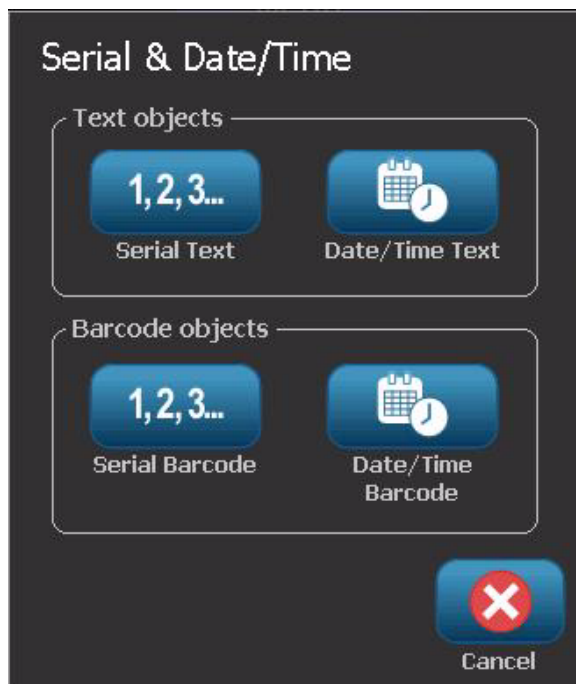

- In the *Date/Time* menu, select the format(s) you want included on the label. The *Preview* area immediately displays the changes.

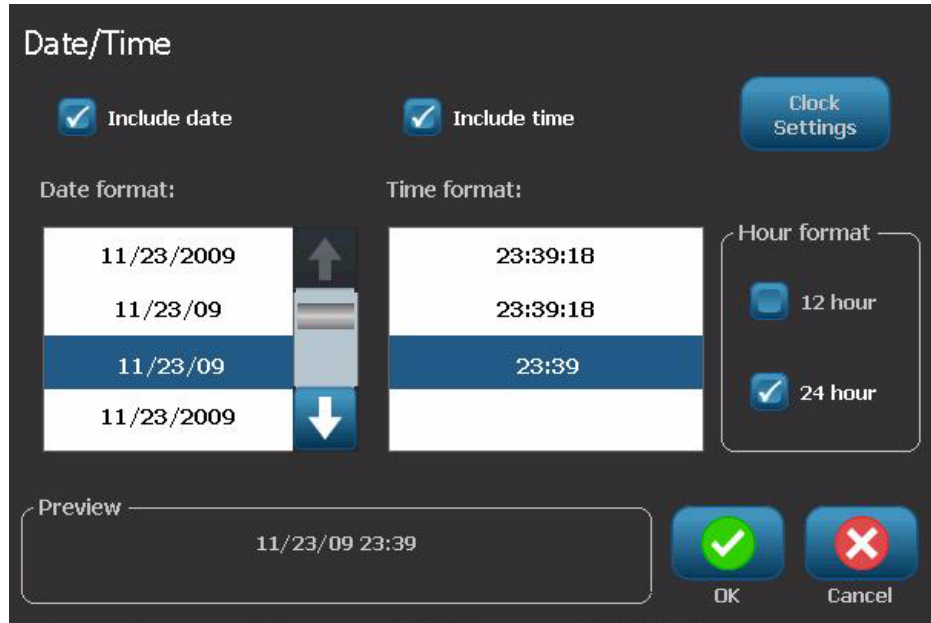

- **Include date:** Toggles the date on or off.
 - **Include time:** Toggles the time on or off.
 - **Date Format:** Format for date printed on label(s).
 - **Time Format:** Format for time printed on label(s).
 - **Hour Format:** 12-hour (AM or PM) or 24-hour time format
- When done, select **OK** . An object with the current date/time value is added to the label.

Note: When printed, the date/time value of each label will reflect the *current* date and time of the printer.

Note: If the system clock has not been set, the system displays a message requesting that you set the system clock. Selecting **OK** takes you to **Clock Settings**. Selecting **Cancel** returns you to the *Editor*.

Working with Text

Selecting or Deselecting Text

To select or deselect words in a text box:

1. In the *Editor*, touch the word(s) you want to select:
 - **Select a single word:** Touch the word. The system highlights the word.
 - **Extend the selection:** Press *Shift* and touch another word in the same text object. The system highlights the additional word(s).
 - **Deselect a word:** Touch the highlighted word. The system deselects the word. If more than one word is highlighted, the system deselects everything *except* the word that was touched.

To select individual characters in a text box:

1. In the *Editor*, choose the object with the character(s) you want to select.
2. Touch the area where you want the selection to start (or use the keyboard ← or → arrow keys).
3. On the keyboard, hold **Shift** and press the ← or → arrow keys to move the cursor to the position where you want the selection to end.

Note: Until **Shift** is released, the selection will be extended by one character each time you press an arrow key.

To select all characters in a text box:

1. In the *Editor*, select a text object.
2. Select **Select All Chars**  . The system selects all characters in the text object.

Increase or Decrease Text Size

When you change a character-level attribute, any highlighted text will reflect the change **and** new text following the current cursor position will also reflect the change. You can grow or shrink the text sizing by this procedure.

To increase text size:

- Type text into a text box. The text will automatically size to fit the size of the text box or as it reaches the label boundary.
- Touch or select a text box and then in the *Control Panel*, select **Size** .
- See also “*Changing Character Font, Size or Style*” on page 4-12.

To decrease text size:



- Press **Enter**. A new line will be started and the text size decreased to fit the text box.
- Touch or select a text box and then in the *Control Panel*, select **Size** .

Delete/Clear Text

To delete/clear text in a text box:

1. With a text label in the *Editor*, touch a text object. The cursor (blinking) is positioned at the end of the text box.
2. To delete or remove text, use these keys on the keyboard:
 - **Backspace**: Deletes character(s) to the *left* of the cursor:
 - **Highlighted Characters**: If characters are highlighted, pressing *Backspace* deletes all of the highlighted text.

Note: Pressing **Enter** deletes any highlighted text *and* starts a new line.

3. To clear all text and leave the text box:
 - a. Select **Select All Chars** .
 - b. On the *Keyboard*, press **Backspace**. Clears highlighted text.
4. To delete all text and remove the text box, touch **Delete**  in the *Tools* section. All text in the selected text box is deleted *and* the text box is removed.





Changing Character Font, Size or Style

Character-level attributes are those that affect a single character or characters in an object (e.g., The "T" in the word Text). Character-level attributes include font, font size and font style (bold, italic and underline).

When you change a character-level attribute, any highlighted text will reflect the change **and** new text following the current cursor position will also reflect the change.

To change a character font, size or style in the Text Attributes control panel:

Note: When you change the text attributes from the control panel, the changes are immediately reflected in the *Editor*. Any subsequent changes will also reflect this change.

1. In the *Editor*, select a single character or characters from the text box.
2. In the *Text Attributes* control panel:
 - Press **Font** , then select the new font type and press **OK**.
 - Press any of the following buttons:   .

To change a character font, size or style in the Fonts dialog box:

1. In the *Editor*, select a single character or characters from the text box.
2. In the *Text Attributes* controls, select **Fonts** 

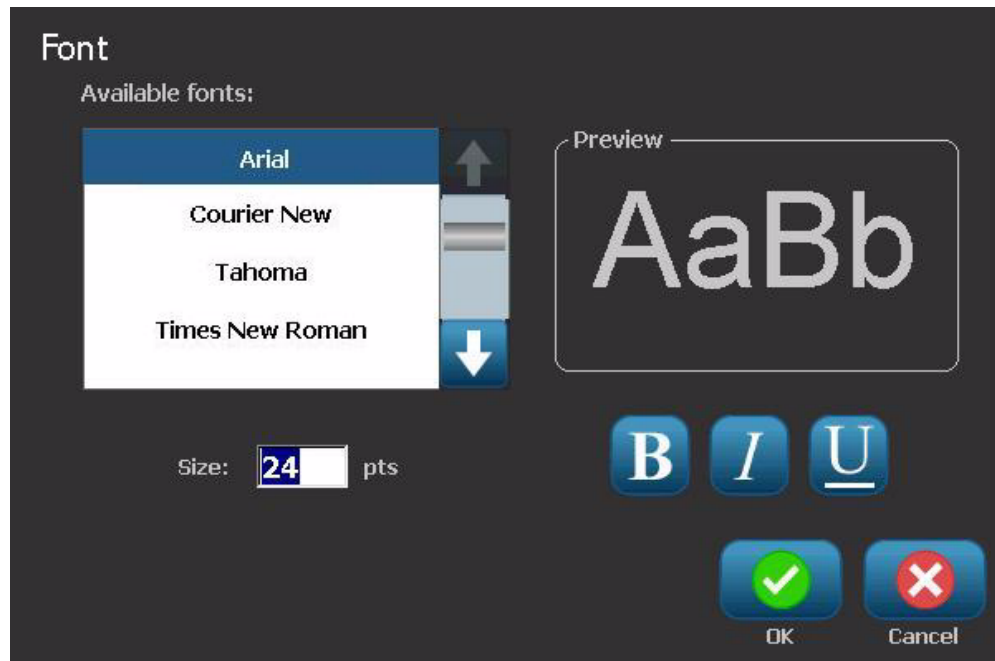



3. In the *Fonts* dialog box, select or change any of the following attributes:
 - **Fonts:** Select from the list of available fonts.
 - **Size:** Type a size for the text. Any highlighted text will change to the new size and new text following the current cursor position will also reflect the change.
 - **Style:** Select Bold, Italic and/or Underline (also see *“Increase or Decrease Text Size”* on page 4-11).
4. When you are done, select **OK**  .

Horizontal Text Justification

Use this procedure to set or change how text is horizontally aligned within the object. This primarily affects text objects with multiple lines; the alignment setting is either at the left edge, center, or right edge of the object.

Note: Horizontal alignment affects the way the text grows as characters are added. Left-justified text grows to the right, center-justified text grows both directions and right-justified text grows to the left.

To set text horizontal justification:

1. In the *Editor*, select the text object you want to change.
2. If not already displayed, select **More Options**  to go to the *Justification* controls.
3. Select the desired justification option (left, center, right) . The text is immediately displayed and justified to the new setting.



Note: Text objects can all be formatted with different alignments, however the last text object set becomes the default for any new text objects during the current editing session. See “*Set Text Defaults*” on page 2-17 for more details.

Vertical Text

Use this procedure to align text vertically as a string of characters.

Once text has been sized to fit vertically, selecting the vertical setting again will not change the text back to the original size. You will have to manually change the text size back to its original setting.

To set text vertically:

1. In the *Editor*, select the text object you want to change.
2. In the *Control Panel*, select **More Options**  to navigate to the *Vertical* controls.
3. Select **Vertical** . The text is immediately displayed vertically on the label.
4. To toggle the vertical setting on and off, select **Vertical**  again.



Notes:

- Line breaks in the text are treated as spaces when the text is formatted vertically.
 - If the vertical object does not fit on the label, the object and text will be resized so it fits within the printable area of the label (i.e., text is not truncated).
-

Expanding or Condensing Text

Use this procedure to expand or condense the text characters horizontally. This does not change the font size.

To expand or condense text:

1. In the *Editor*, select the text object you want to expand or condense.
2. In the *Control Panel*, select **More Options**  to navigate to the *Expand/Condense* controls.
3. Select **Expand**  or **Condense** . The text is immediately displayed expanded or condensed on the label.



Note: Text expands or condenses 50% to 200% in 10% increments. If the limits are reached, the Expand/Condense buttons have no further effect.

4. Repeat *Step 3* to continue expanding or condensing the text.

Reversing Text

Use this procedure to format text with the foreground and background colors reversed (i.e., black on white background or white on black background).

To set reverse text output:

1. In the *Editor*, select the text object you want formatted in reverse.
2. In the *Control Panel*, select **More Options**  to navigate to the *Reverse* control.
3. Select **Reverse** . The text is immediately displayed with the foreground and background colors reversed.
4. To toggle the setting on or off, select **Reverse**  again.

Typing Text and Accented Characters

As with standard PC keyboards, each character key supports multiple characters when used in combination with the <Shift> and <Alt Gr> keys.

Keycaps show characters in one of four positions (see Figure 4-1). The character position on the physical key indicates how to access the characters with the <Shift> and <Alt Gr> keys.

Characters that require 2 keystrokes are not differentiated in any way, however, they will respond differently when selected. For example, when an accented character is typed, it will not display until the letter to be modified is also typed. The accented character will then be displayed with the letter.

Understanding Keystroke Combinations

- The term "Key" represents the physical key on which the accent character is located.
- The "+" sign indicates that two or more keys should be pressed simultaneously.
- A comma separating a keystroke combination indicates that the first set of keys should be released before typing the next keystroke combination.

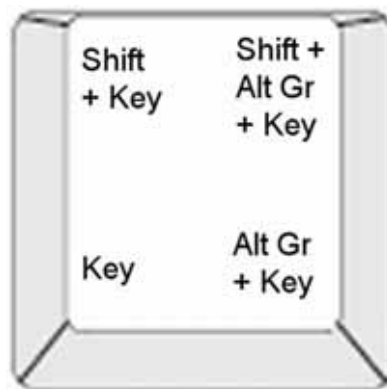

Figure 4-1. Keystroke Combinations

Typing Accented Characters

To access accented characters, typing the key combinations may vary depending on the keyboard configuration you are using. The following shows an example of using each of the 4 key combinations.

Note: See “Character Mapping & Keyboard Layouts” on page B-1 for a list of accent characters available with specific keyboards and the keyboard configurations.

To type an accented character:

1. On the keyboard, locate the key with the accented character you want applied.
2. Type the appropriate keystroke combination (see Figure 4-1). The table shows example keystroke combinations.

Note: The keyboard configuration used in all of the examples is North American QWERTY, except the ring, which used the European QWERTY.

Result	Accent Key	Keystroke Combination
ç	Cedilla	Lower Case: Alt Gr + Key Upper Case: Shift + Alt Gr + Key
ô à	Circumflex Grave	Lower Case: Shift + Alt GR + Key, Letter Upper Case: Shift + Alt GR + Key, Shift + Letter
é ñ	Acute Tilde	Lower Case: Alt-GR + Key, Letter Upper Case: Alt-GR + Key, Shift + Letter
ä	Dieresis (umlaut)	Lower Case: Shift + Key, Letter Upper Case: Shift + Key, Shift + Letter
å	Ring	Lower Case: Alt + Key, Letter Upper Case: Alt + Key, Shift + Letter

Entering Special Characters

Use this procedure to enter text characters, such as accented characters or special characters, that are *not* present on the physical keyboard.

To enter special characters:

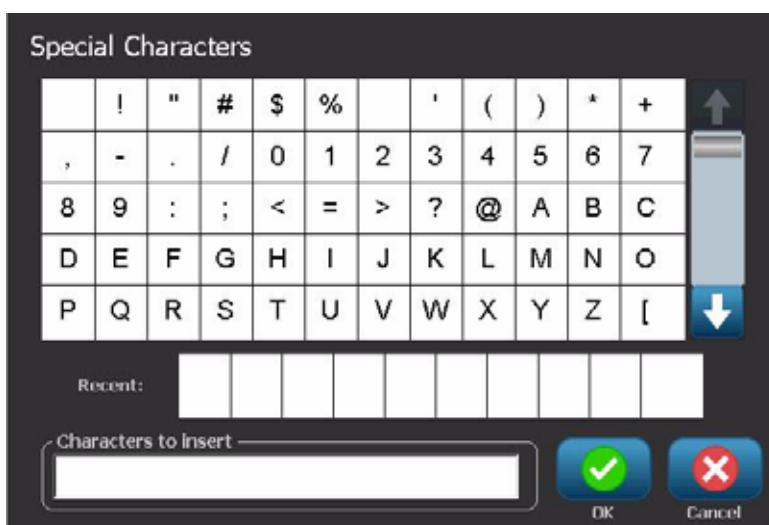

1. In the *Editor*, choose a text object then select **Special Characters** . A list of available characters is displayed.

Note: The available characters depend on the font you are using.



2. Select the character(s) you want to enter (you can select more than one character at a time). The selected character(s) immediately display in the *Characters to Insert* area.

Notes:

- If you want to mix special and normal characters, you can also type into the *Characters to Insert* area.
- Press **Up**  or **Down**  arrows to scroll through the available characters.

3. To delete characters from the area, press **Backspace** or highlight the characters and press **Delete**.
4. When you are done choosing special character(s), select **OK** . The special characters are inserted in the active text object at the current cursor position.

Working with Barcodes

Changing a Barcode

To change a barcode:

1. In the *Editor*, select a barcode object.
2. Select **Change Barcode**  .

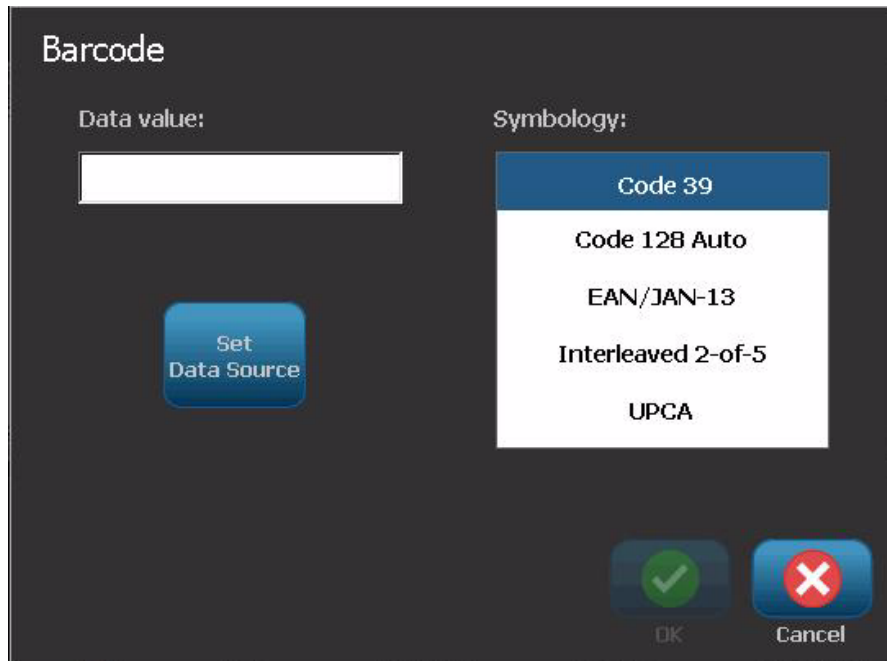

The image shows a 'Barcode' dialog box with a dark background. On the left, there is a 'Data value:' label above a white text input field. Below the input field is a blue button labeled 'Set Data Source'. On the right, there is a 'Symbology:' label above a list of barcode symbologies: Code 39, Code 128 Auto, EAN/JAN-13, Interleaved 2-of-5, and UPCA. At the bottom of the dialog are two buttons: 'OK' with a green checkmark icon and 'Cancel' with a red 'X' icon.

3. In the *Barcode* dialog box, change the desired options:
 - **Data value**
 - **Symbology**
 - **Set Data Source** (optional). See “*Converting Text or Barcode to Variable Data*” on page 4-31 for details.
4. When done, select **OK**  .

Changing Barcode Options

Barcode options include changing the barcode symbology and data value, setting a different ratio and density and increasing or decreasing the barcode size.

Barcode Size

To change the barcode size:

1. In the *Editor*, select a barcode object.
2. In the *Control Panel*, select **Size**  to increase or  to decrease the barcode vertically. Changes are immediately reflected in the *Editor*.

Barcode Ratio

Ratio is the thickness between a narrow bar and a wide bar (overall width of the barcode). Usually, the ratio is between 2:1 and 3:1. Does not apply to all symbologies.

To change a barcode ratio:

1. In the *Editor*, select a barcode object. If the *Barcode Content* dialog box opens, select **Cancel**.
2. In the *Control Panel*, choose from one of the three options . Changes are immediately reflected in the *Editor*.

Barcode Density

Density controls the width of the barcode lines and spaces (choose between 10 and 80 mils). Typically, the thinner the bar and spaces, the higher the bar code density and the less space it takes on a label.

To change the barcode density:

1. In the *Editor*, select a barcode object.
2. In the *Control panel*, select **Density** .
3. In the *Barcode Density* dialog box, choose a density for your barcode.

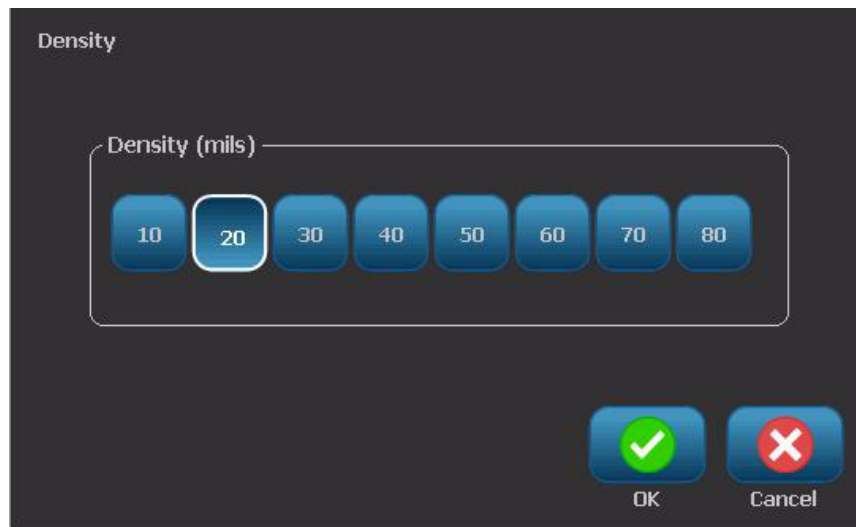

4. Select **OK**. The changes are immediately reflected in the *Editor*.

Working with Barcodes

Changing Barcode Options

Human-Readable Text Options



Barcode text options let you choose whether to show any human-readable text on your barcode and where it should be positioned (above or below the barcode).

You can also decide whether you want the text to include a check character or a start/stop character.

To add human-readable text:

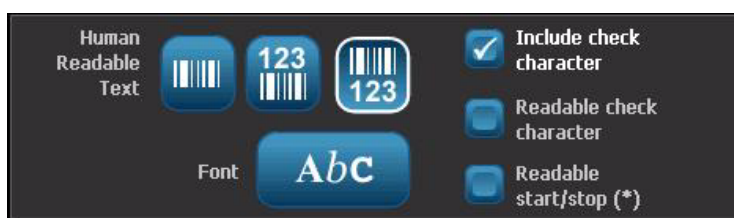
1. In the *Editor*, select a barcode object.
2. Select **More Options**  and go to the *Human Readable Text* control panel.



3. Choose the **Human-Readable Text** option you want: *none*, *above barcode* or *below barcode*.
4. To choose a font and/or size for your human-readable text, select **Font** .
5. In the *Font* dialog box, choose a font, size and/or style for the human-readable text that will be included on your barcode.
6. When done, select **OK** . The barcode reflects the changes.
7. Select the check character options you want for your barcode. The changes are immediately reflected in the *Editor*.

Handling Objects

Editing Objects

To edit an object, touch the object and then edit it using any of the settings and/or attributes available in the Control Panel. If you want to change to a different graphic or barcode, select **Change Graphic** or **Change Barcode**, then change any of the options available in the *Barcode* or *Select Graphic* dialogs.

Moving Objects

Use this procedure to reposition objects on the label. Objects can be positioned either by dragging, using arrow keys on the keyboard, or by setting specific x- and y-coordinates. They can also be positioned by aligning them to one of the edges of the label or centering them either horizontally or vertically on the label.

Note: Objects must be entirely contained within the printable area of the label.

Drag Objects

To drag an object:

1. In the *Editor*, select the object you want to move.
2. Drag the object to the new location.

Notes:

- If you drag an object off the edge of the displayed part of the label (but still within the label boundary), the display will automatically scroll so the object stays visible.
 - If you move an object so that some or all of the object is outside the printable area of the label, the object will be repositioned within the label boundary.
-

3. Repeat Step 2 until the object is where you want it.

Use Keyboard Arrow Keys

To move an object using keyboard keys:

1. In the *Editor*, select the object you want to move.
2. On the keyboard, press the up, down, left, or right arrow key [↓←→↑] to move the object in the corresponding direction. If you hold down the shift key while using the arrows, the objects move in larger increments.



Note: The text-editing panel cannot be displayed if you want to move a text object using the arrow keys. If the text-editing panel is displayed, using the arrow keys will move the cursor within the text box. To exit text editing mode, select **More Options**, then use the arrow keys to move your object.

3. Repeat Step 2 until the object is positioned where you want it.

Set Object Position

Use this procedure if you want to move an item on the label to a specific position by setting the specific x- and y-coordinates.

To move an object using object position coordinates:

1. In the *Editor*, select the object you want to move.
2. In the *Control Panel*, select **More Options**  to navigate to the *Exact Size & Position* option.
3. Select **Exact Size & Position** .
4. Type a value for:
 - **Distance from the top of label** (Y coordinate).
 - **Distance from left edge** (X coordinate).

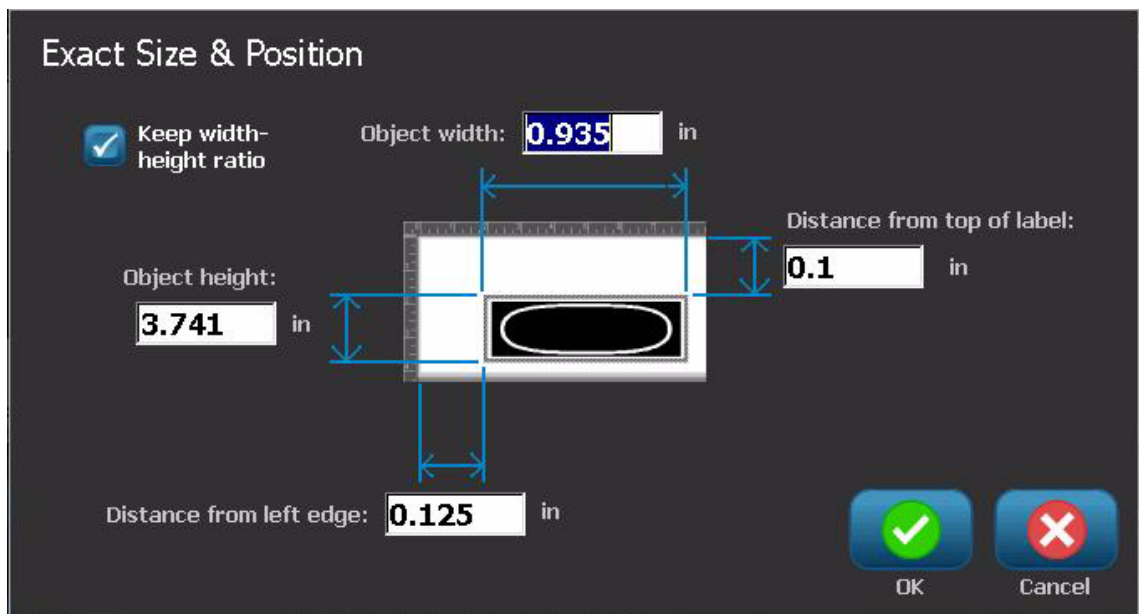

5. When done, select **OK** . The object is displayed at the specified position.

Note: If the values entered result in the object being positioned outside the printable area, the system resizes and repositions the object to fit on the label.

Aligning Objects

To align objects on label:

1. In the *Editor*, select the object you want to align.
2. Choose **More Options**  and go to the alignment *Control Panel*:





3. Choose the alignment option(s) you want (changes are immediately reflected in the *Editor*):
 - **Center on Label:** Positions the object in the *vertical* or *horizontal* center of the label.
 - **Align to Label Edge:** Align object to *top*, *bottom*, *left* or *right* of label edge. If the object already reflects an option, or if the option cannot be used for this object, the button is greyed out.

Note: If an option is unavailable, or if the object already reflects the change, the option button(s) are greyed out.

Example:

To move an object to the upper left corner:

- a. Touch  (top).
- b. Touch  (left).



Sizing Objects

Use this procedure to set the object size. Objects can be sized by using the size buttons, dragging objects to size or setting object label length and width.

Note: Sizing an object too large may cause it to overlap or cover other objects in the *Editor*.

Use Size Buttons

To use the size buttons:

1. In the *Editor*, select the object you want to resize.
2. In the *Toolbar*, touch increase  or decrease  button. Increasing or decreasing the object size with the **Size** buttons results in proportional resizing only.

Note: For barcode objects, resizing occurs only in the direction of the barcode bars (usually the vertical direction, unless the barcode has been rotated).

3. Repeat *Step 2* until the object is the size you want.

Drag Objects to Size

To drag objects to size:

1. In the *Editor*, select the object you want to resize.
2. In the *Tools* panel, touch **Size**  to display the sizing handles on the object.

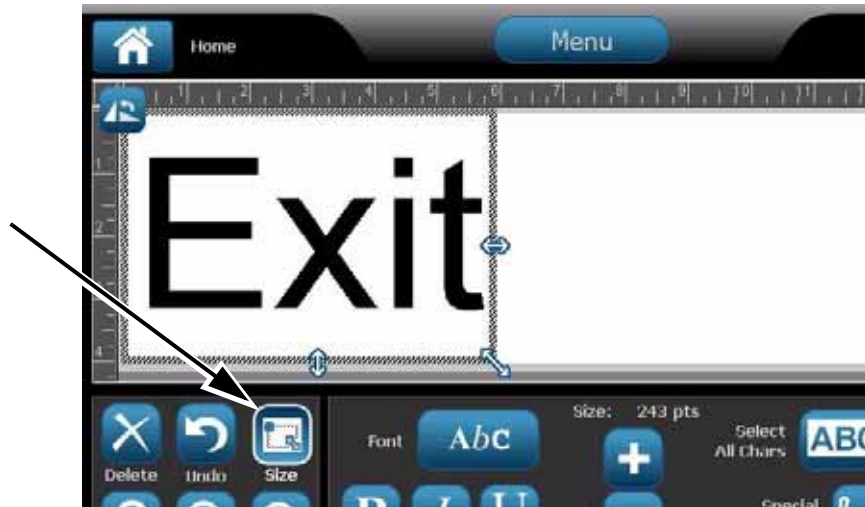



Note: If an object is rotated, the non-proportional sizing handles are hidden. To size non-proportionally, return the object to an unrotated state (0 degrees).

3. Touch a handle and drag on the touch screen to resize the object:
 - **Proportionally:** Drag the corner handle to resize the object proportionally.
 - **Non-Proportionally (Width):** Drag the right-side handle to stretch or shrink the object width in the direction of the handle only.
 - **Non-Proportionally (Height):** Drag the bottom handle to stretch or shrink the object width in the direction of the handle only.
4. To hide the sizing handles, touch **Size**  again.

Set Object Size

Use this procedure if you want to size an object by setting the object height and width.

To size an object using object dimensions:

1. In the *Editor*, select the object you want to resize.
2. In the *Control Panel*, select **More Options**  to navigate to the *Exact Size & Position* option.
3. Select **Exact Size & Position** .
4. To maintain the object proportions, select **Keep width-height ratio**.
5. Type a value for:
 - **Object width**
 - **Object height**

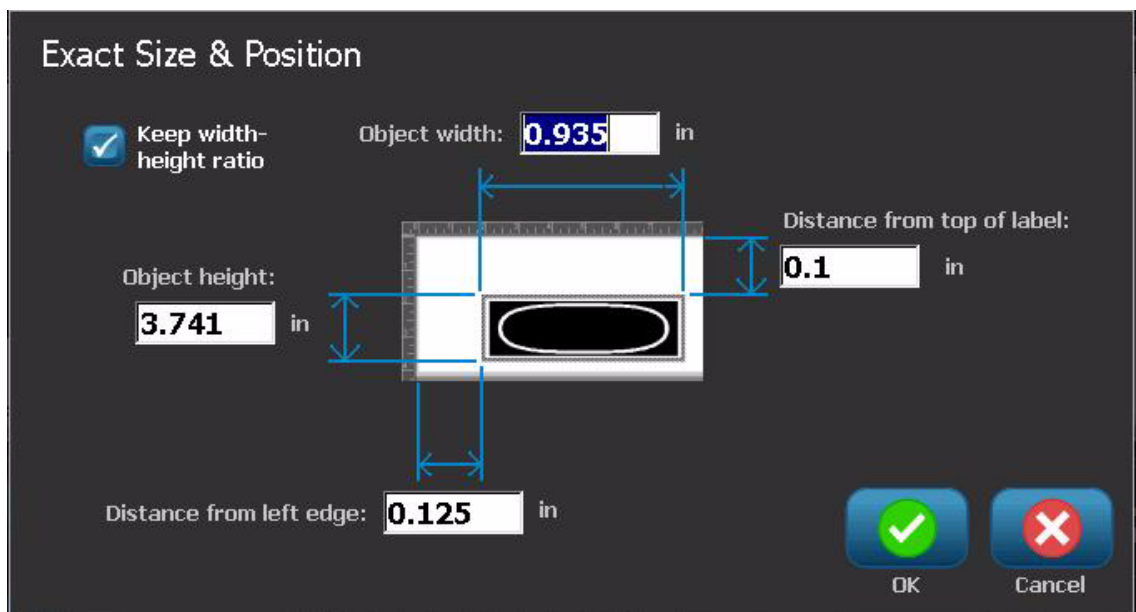

6. When done, select **OK** . The object is displayed at the specified size.

Note: If the values entered result in the object being positioned outside the printable area, the system resizes and repositions the object to fit on the label.

Deleting an Object

To delete an object from a label:

Note: This procedure does not delete the text within an object. To delete text, see “Delete/Clear Text” on page 4-11.

1. In the *Editor*, select the object you want to delete.
2. Touch **Delete**  or press **Del** on the keyboard.

Framing an Object

To place (or remove) a frame around an object, the object must be either text or graphic. Barcode objects cannot be framed. When selected, changes are immediately reflected in the *Editor*.

Note: To frame the entire label, see “Framing a Label” on page 3-6.

To frame an object on a label:

1. With a label defined in the *Editor*, select the object you want to frame.
2. Select **More Options**  and go to the *Object Frame* panel.





3. Select the *Shape* you want around the object (none, rectangle, rounded).
4. Select a *Line Width* for the frame (narrow, medium, wide).

Handling Objects

Rotating an Object

Rotating an Object

To rotate an object:

1. In the *Editor*, touch the object you want to rotate.
2. In the *Tools Panel*, touch **Size**  [1] to display the sizing and rotation handles.
3. On the label, touch **Rotate**  [2]. The object is rotated 90° counterclockwise.



Note: When rotated, the text font will be reduced so that the entire text box fits on the label. The font size will stay reduced even if the object is rotated back to its original position (a full 360°).

4. Repeat *Step 3* to rotate the object further (selecting **Rotate** 4 times returns the object to the original unrotated state).

Converting Text or Barcode to Variable Data

Use these procedures to convert an existing text or barcode object into a serial or date/time object on the label. This applies to both template or freeform objects.

Note: You cannot add serial data to a graphic.

Convert to Serial Data

To convert text or barcode to serial data:

1. In the *Editor*, select the text or barcode object that you want to use for the serial data.
2. **Text:** Select **More Options**  and go to **Set Data Source**.
 - or -

Barcode: Select **Change Barcode** .

3. Select to **Set Data Source** .



4. In the *Set Data Source* dialog box, select from the following options to choose the data source and change the format options:
 - **Constant:** Fixed (non-variable) object.
 - **Serial**
 - **Date/Time:** Places a date/time object on your label.
5. Select **Serial** . Displays the *Serial & Date/Time* dialog box. See “*Serial Objects*” on page 4-6 for details.

Handling Objects

Converting Text or Barcode to Variable Data

- In the *Serial* dialog box, type or select values for setting the serial attributes (the *Sample* area will immediately display an example of the selections):

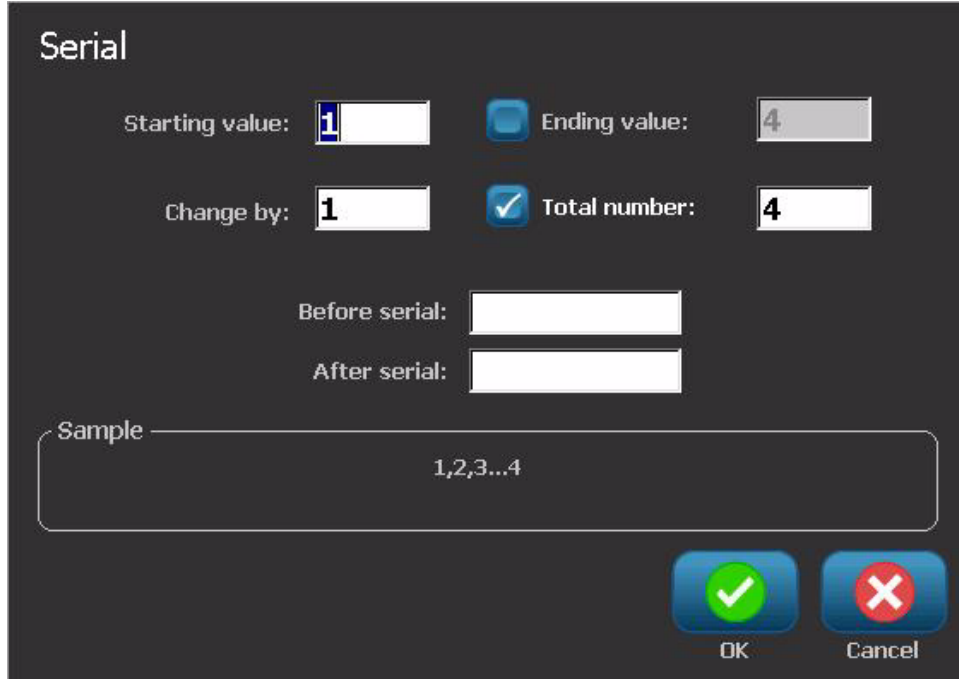

Serial

Starting value: Ending value:

Change by: Total number:

Before serial:

After serial:

Sample

- When you select **OK** , The text or barcode object is converted to a serial object on the label.

Convert from Serial Data

Use this procedure if you want to convert a serial object to constant data.

To convert text or barcode to constant data:

1. In the *Editor*, select the serialized text or barcode object that you want converted to constant data.
2. **Text:** Select **More Options**  and go to **Set Data Source**.
 - or -

Barcode: Select **Change Barcode**  .

3. Select **Set Data Source**  .



4. In the *Set Data Source* dialog box, select **Constant**  . The Barcode dialog opens and gives you the option to change the data value.

Note: If you do not change the data value, it will default to the value shown in the *Data value* box.

5. Select **OK**  . The object will change to fixed (non-serialized) data.

Handling Objects

Converting Text or Barcode to Variable Data

Convert to Date/Time

To convert a date/time object to constant data:

1. Select an object.
- or -
Touch the *Editor* to create an object.
2. Touch **Serial & Date/Time** . Displays the *Date/Time* dialog box. See “*Serial Objects*” on page 4-6 for instructions.
3. In the *Serial & Date/Time* dialog box, choose either **Date/Time Text** or **Date/Time Barcode**.
4. In the *Date/Time* dialog box, choose the settings you want for the object.

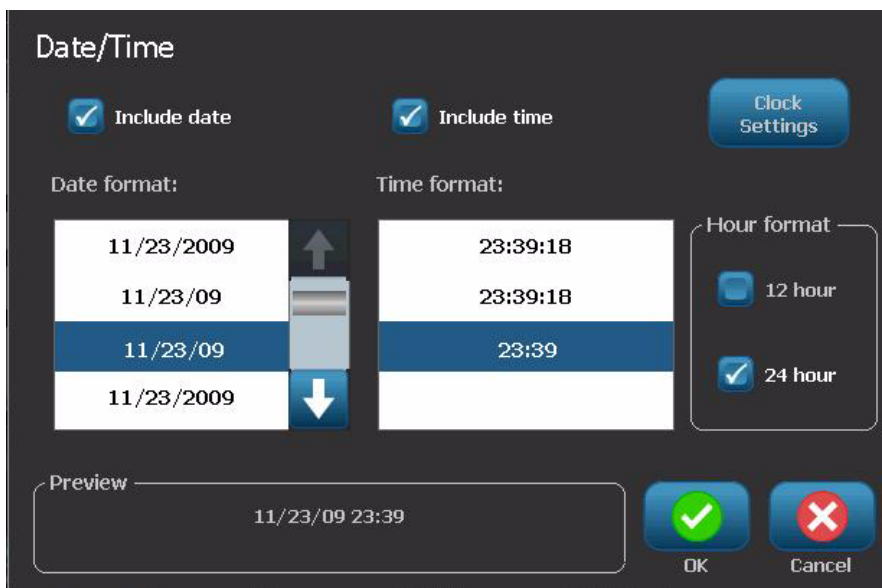



5. When done, touch **OK** .

Convert from Date/Time

To convert a date/time object to constant data:

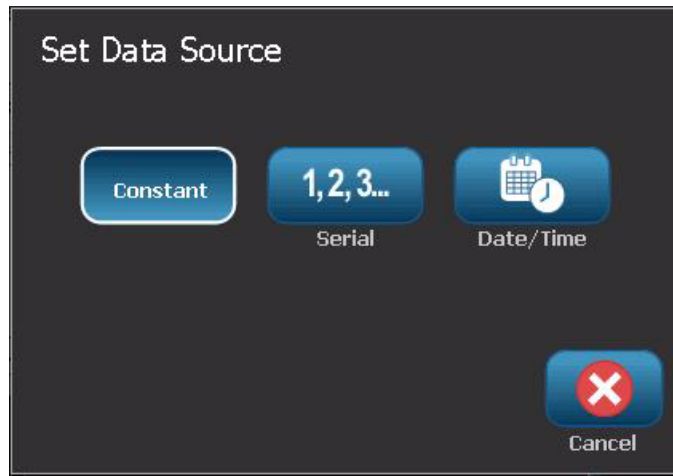
1. Select the date or time object.
2. Select **More Options**  to go to the *Set Data Source* option.
3. Select **Set Data Source**  .



4. Select **Constant**  . The date/time is converted to editable data.

5 Printing Your Labels

Previewing Labels

The Preview options differ depending on whether the label is a standard label or a serialized label.

Previewing a Label without Serialized Objects

To preview a label with no serial data:

1. With a defined label in the *Editor*, select **Print** .

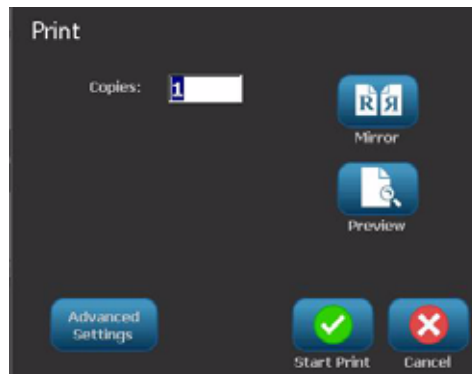

2. From the *Print* dialog box, select **Preview** . The entire label is displayed for your review.



3. Select **Start Print**  or **Cancel** .

Previewing Labels



Previewing a Label with Serialized Objects

Previewing a Label with Serialized Objects

To preview a serialized label:

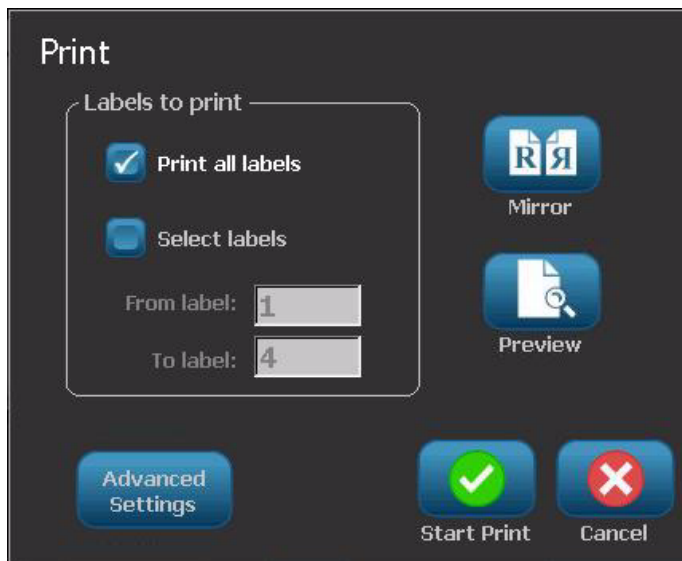
1. With a defined label in the *Editor*, select **Print** .



2. Select **Preview** . The entire label is displayed, plus options to view the other labels generated by the serial object.
3. Select **Next Label**  or **Previous Label**  to view the labels generated from the serial object.



4. Select **Start Print**  or **Cancel** .

Printing Labels

As you print your labels, keep the following in mind:

- During printing, the print status is displayed and the *Editor* is unavailable. When printing is complete, you are returned to the *Editor*.
- The printer cuts between labels or at the end of the job, according to the selected cut settings.
- If there is no media or ribbon installed, printing does not start and you will be prompted to install media or ribbon.
- If you open the ribbon cover during the print operation, printing stops and a message displays prompting you to close the cover. The print job is canceled. To print the label(s), you must restart the print job.

Printing Labels without Serialized Objects

Use this procedure to print your label. If your label contains a serial object, see “*Printing Labels with Serialized Objects*” on page 5-4.

To print labels without serialized objects:

1. With a defined label in the *Editor*, select **Print** . The *Print* dialog box displays with default copies set to 1.

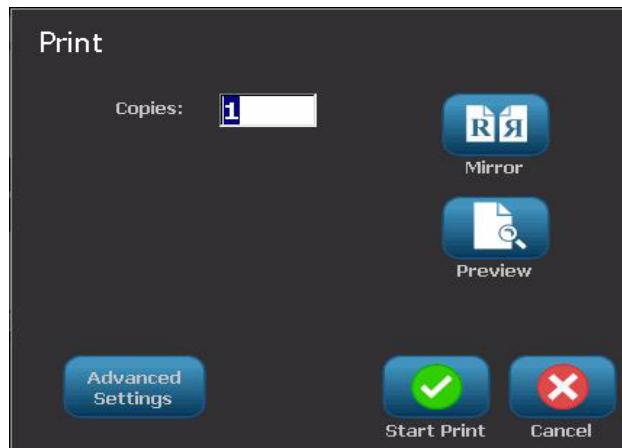

2. From the *Print* dialog box, select the print options:
 - **Copies**
 - **Mirror**
 - **Preview**
 - **Print energy** (accessed from the *Advanced Settings* button)
 - **Adjust Offset** (accessed from the *Advanced Settings* button)
3. Select **Start Print**  to start printing the label.

Printing Labels

Printing Labels with Serialized Objects

Printing Labels with Serialized Objects

Use this procedure to print labels that contain a serial object. If your label does not contain a serialized object, see *“Printing Labels without Serialized Objects”* on page 5-3.

Note: You can only select one set of copies when printing labels that contain serialized objects. However, If the label includes more than one serial object, the option to “print all labels” results in one complete set of the labels generated from the serial object that prints the most labels; the shorter series will repeat until the longer series is completed.

To print labels with serialized objects:

1. With a serial label in the *Editor*, select **Print** .
2. From the *Print* dialog box, select the print options:
 - **Labels to print** (print all labels, or select a range of labels to print)
 - **Mirror**
 - **Preview**
 - **Print energy** (accessed from the *Advanced Settings* button)
 - **Adjust Offset** (accessed from the *Advanced Settings* button)

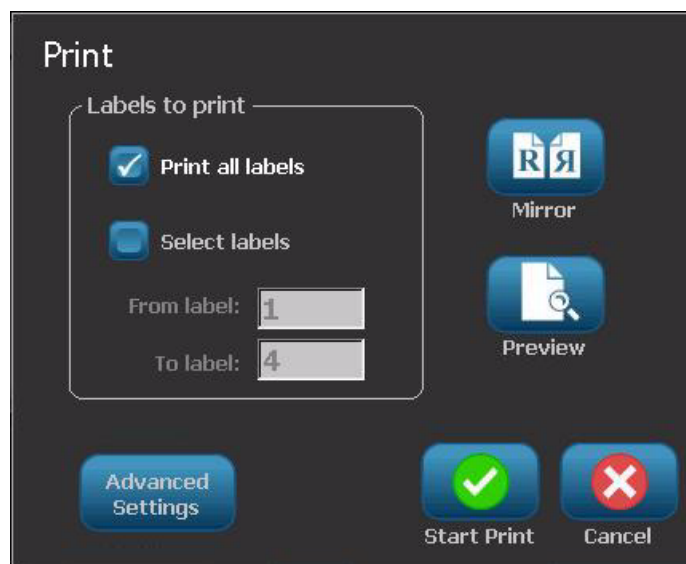



3. Select **Start Print**  to start printing the labels.

Printing Mirror-Image Labels

Use this procedure to print labels suitable for reading in a mirror or through the back of the label.

To print a mirror-image label:

1. With a defined label in the *Editor*, select **Print** .
2. From the *Print* dialog box, select **Mirror** .
3. Select **Start Print**  to start printing the labels. The labels are printed mirrored across the media.

Note: The Mirror setting is **not** retained for the next print job. The Mirror setting must be reselected each time you want to print mirror-image labels.

Canceling a Print Job

This procedure assumes that a print job has been initiated and is currently printing.

To cancel a print job:

1. In the *Printing Status* dialog box, select **Cancel** . The printer immediately stops printing, displays a *print job cancelled* message, and cuts the media.

Note: Once Cancel is selected, the print job cannot be resumed.

Printing Labels

Resuming an Interrupted Print Job

Resuming an Interrupted Print Job

Use this procedure to resume a print job that was interrupted.

To resume an interrupted print job:

1. When the job interruption message displays, correct the condition that caused the interruption (e.g., replace the media or ribbon).
2. Select the option to continue:
 - **Resume Current** (reprints the current label, then continues printing)
 - **Resume Next** (prints the next label, then continues printing)
 - or -
 - **Cancel** the print job.

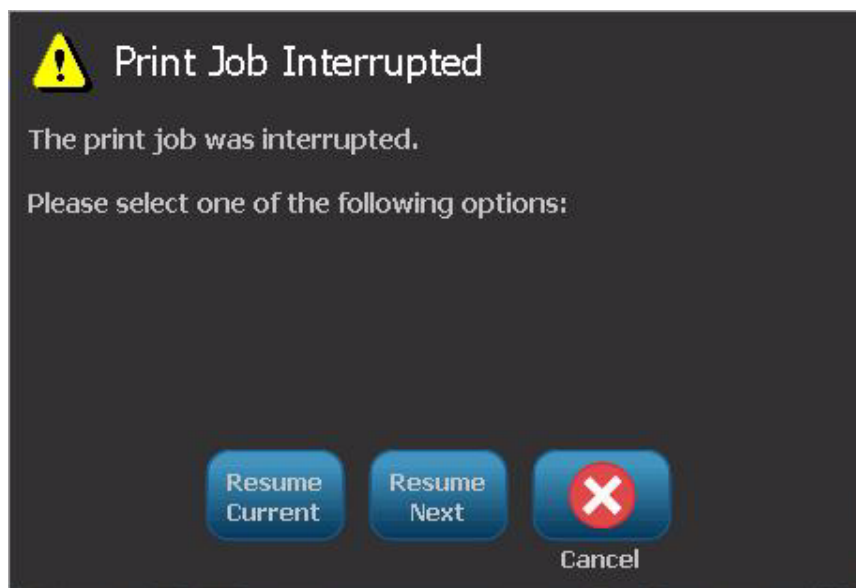

Adjusting Print Energy



If your printing is spotty, you may want to increase the print energy to make sure more of the ribbon ink transfers to the label. However, if your ribbon is sticking or tearing during printing, the heat energy may be too high and should be reduced.



CAUTION!

Constantly printing at high energy levels may cause printer jams or other printing errors and may reduce the overall life of your printhead.

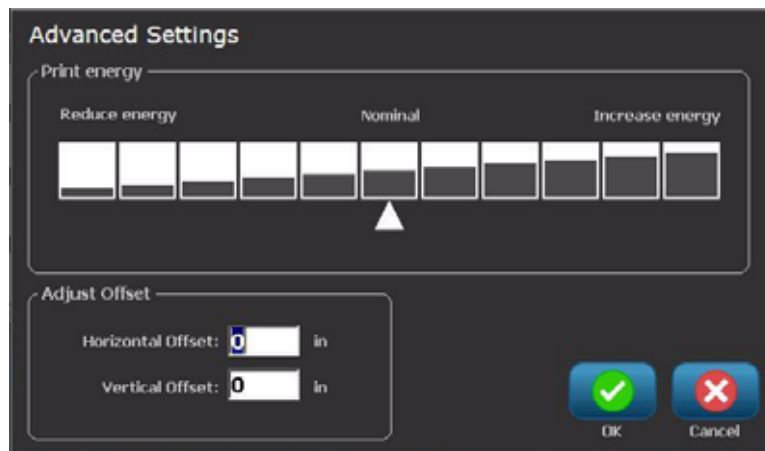

To adjust the print energy:

1. With a defined label in the *Editor*, select **Print** .
2. In the *Print* dialog, select **Advanced Settings** .



3. In the *Print Energy* area, select the appropriate box to increase or decrease the print energy level.

Note: By default, the print energy is at the nominal setting for the best overall performance.



4. Select **OK** . The print energy level is changed and the *Print* dialog box is displayed.
5. Choose your print options and select **Start Print** . The system uses the new setting for printing the label(s) in this print job.

Note: The selected print energy setting will stay in effect for all subsequent print jobs with the currently installed media. When new media is installed, the print energy level is reset to the default setting. The print energy level is also reset by rebooting the system.

Adjusting Print Offset

Print Offset is a value that will move the image from its "nominal" position slightly in one direction or another on the label. Adjust Offset is typically used to do a fine adjustment of the printed image on a die-cut label, or to move the image slightly closer or further from the edge of a continuous supply.

To adjust the print offset:

1. With a defined label in the *Editor*, select **Print** .
2. In the *Print* dialog, select **Advanced Settings** .

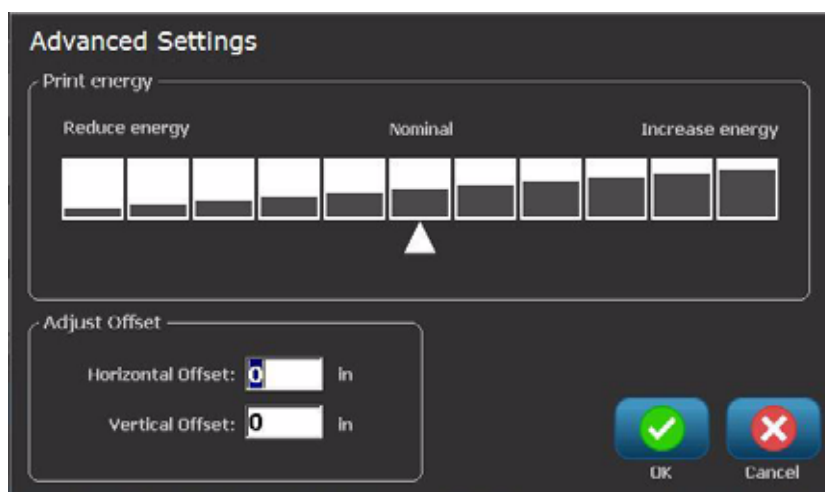

3. In the *Adjust Offset* area, enter a value in the horizontal and/or vertical offset boxes:
 - **Horizontal Offset:** shifts the image (printed portion of the label) to the right or left.
 - **Vertical Offset:** shifts the image (printed portion of the label) up or down.

Printing from a PC

Use this procedure to print labels that you created on a PC. See “*Compatible Applications*” on page 1-2 for more details.

Note: To use this procedure, the printer must be physically connected to PC, the appropriate drivers (i.e., printer driver, USB driver) must be installed on the PC (see “*Using Your Printer with a PC*” on page 2-12) and the **BBP™31** printer must be powered on.

To print from a PC:

1. From the label creation application at the PC, start the print job. The PC will send the data to the printer.

Note: If the printer is already printing when the data is sent from the PC, the printer will not acknowledge the data and eventually the PC will time out and display an error message.

2. When the printer starts printing the job, let the job print, or select **Cancel**



to cancel the print job.

Note: All standalone printer capabilities are disabled or unavailable while printing from the PC.

6 Working with Label Files

Save a Label File

Use this procedure to save a label file.

1. With a label created in the *Editor*, select **Menu** .
2. Select **Save File** . The *Save File* dialog box displays.

Note: If the label was previously saved, the system defaults to that location and file name. If the storage location is no longer available (e.g., the external storage location has been removed), the system defaults to the internal memory location.

3. Choose a **Label Location**:
 - **Internal Memory** (file is saved on the printer).
 - **External USB** (file is saved on a USB flash drive). If the location is full, no files can be saved until one or more files in that location are deleted.

Note: The system will support only one USB flash drive at a time.

4. Choose a **Category** or select **New Category**  and type a category name.
5. Choose a **Filename**: Type a name for the label file, or confirm the existing label file name, if the file has been previously saved in this location. The system will not let you type illegal characters.



Note: If filename already exists, the system will ask if you want to replace the existing file.

6. Select **OK**  to save the label file. The label remains displayed in the *Editor*.



Open a Label File

Use this procedure to retrieve a label file that has been saved in internal or external storage.

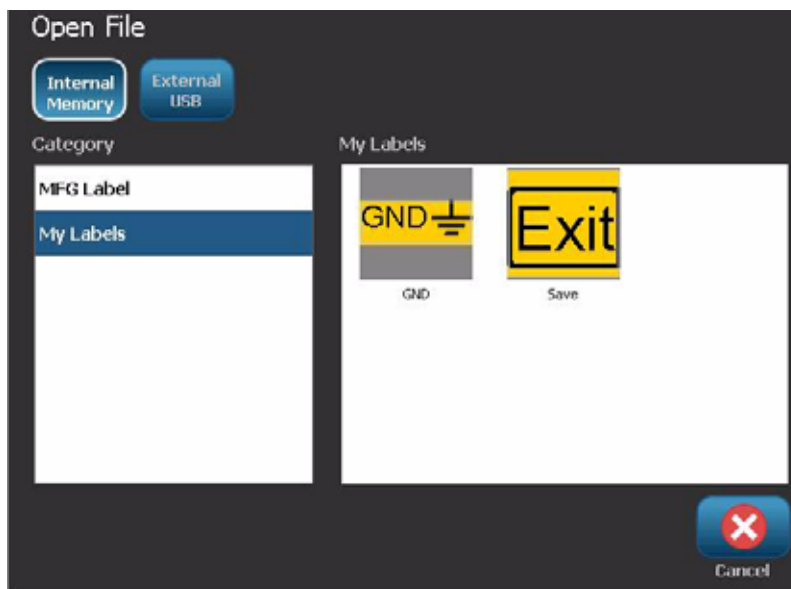

1. Select **Menu** .
2. Select **Open File** . If a label file with unsaved changes is currently in the *Editor*, you will be prompted to save the current label. Click **No** if you do not want to save the label.
3. In the *Open Label File* dialog box, select the **Location** and **Category** where the file is stored. The system will display all of the label files available at that location.
4. Select the label file you want to open. The label will immediately open in the *Editor*.

Note: If the selected label does not fit on the currently installed media, you will be prompted to have the system make the data fit, or cancel the operation. If you choose to make the data fit, objects will be moved and/or resized to fit on the label.



Delete a Label File

To delete a label file:

1. Select **Menu** .
2. In the menu list, select **Delete File** .
3. In the *Delete Label File* dialog box, choose the location where the file is located:
 - **Internal Memory** (label files saved on the printer)
 - **External USB** (label files saved on a USB flash drive)

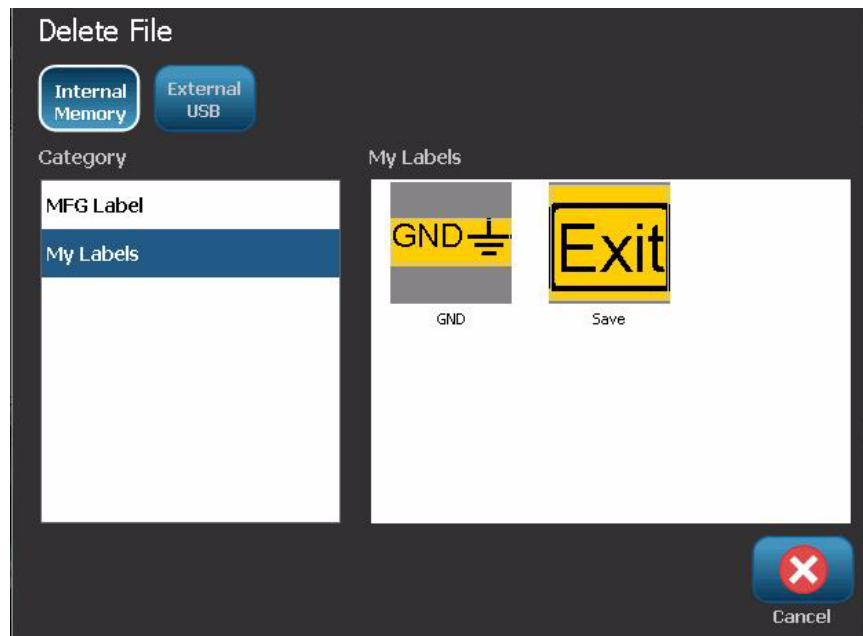

4. Choose the **Category** where the label is saved. The system will display the label files available in the selected location.
 5. Touch the label file you want deleted.
 6. At the prompt to confirm file deletion, select **Yes**. The file is permanently deleted.
- or -
- Select **No** if you want to return to the previous screen without deleting the file.

Note: If you delete all labels in a category, the system will automatically delete the category (except My Labels).

7 Using System Tools

Import Graphics

Use this procedure to add your own graphics for use in labels that will be created on the printer. Graphics that will be imported must be in the supported format(s) and imported from a USB flash drive. Supported graphics file formats are Windows metafile (*.wmf) and Bitmap (*.bmp).

Note: This is a monochrome printer. Imported graphics should be black and white.

Windows metafile (*.wmf) formats are vector images that maintain their clarity and crispness when they are resized. Bitmap files (*.bmp) are composed of pixels which may appear fuzzy and become distorted when they are resized. Be sure to choose the correct format for the graphic you are using.

To import a graphic:



1. Copy the graphics you want to import into the root directory of the USB flash drive you will be using.
2. Connect the USB flash drive that contains the graphic(s) to any available USB port on the printer.

Note: The system will only support one USB flash drive at a time.

3. Select **Menu**  .

4. Select **Import** . The *Import* dialog box displays.



5. In the *Import* dialog box, select **Graphics** .
6. In the *Available:* list, select the graphic you want to import. A preview of the selected graphic shows at the bottom of the dialog box.
7. Select **Import** . The graphic will be imported and the name will display in the *Installed* list.
8. Repeat Step 5 until all of your graphics have been selected.
9. Select **OK** .

Note: If there is not enough space available to store the imported graphic(s), you will have to clear some space by deleting saved files (“*Delete a Label File*” on page 6-3) or deleting previously imported files (“*Delete Imported Graphics*” on page 7-3) before you can import any new graphics. There is approximately 56MB of storage space available.



Delete Imported Graphics

Use this procedure to delete your own imported graphics that you no longer need.

To delete a graphic:

1. Select **Menu** .
2. Select **Import** . The *Import* dialog box displays.



3. In the *Import* dialog box, select **Graphics** .
4. In the *Installed:* list, select the graphic you want to delete.
5. Select **Delete** .
6. Select **Yes** to confirm the deletion. The graphic will be deleted from the *Installed* list.
7. Repeat Step 5 to delete additional graphics.
8. Select **OK**  to exit the dialog.

Import Fonts

Use this procedure to add your own fonts for use in labels created on the printer. Only True-Type fonts can be imported.



To import a font:

1. Copy the fonts you want to import into the root directory of the USB flash drive you will be using.
2. Connect the USB flash drive to any available USB port on the printer.

Note: The system will only support one USB flash drive at a time.

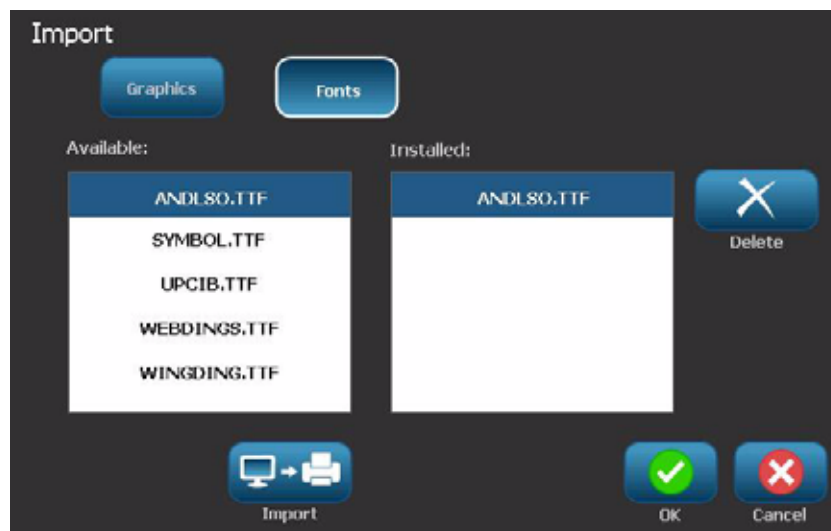
3. Select **Menu** .
4. In the menu options list, select **Import** . The *Import* dialog box displays.



5. In the *Import* dialog box, select **Fonts** .
6. In the *Available* list, select the font you want to import.
7. Select **Import** . The font will be imported and the name will display in the *Installed* list.
8. Repeat Step 5 until all of your fonts have been selected.
9. Select **OK** .

Note: If there is not enough space available to store the imported font(s), you will have to clear some space on the system before you can import any new fonts. You can clear space by deleting saved files. There is approximately 56MB of storage space available.

Printer Upgrades

Future upgrades to **BBP™31** software can be downloaded from the **Brady** website at: www.bradyid.com/bbp31 or www.bradyeurope.com

To download printer upgrades:

1. Click **Support>Downloads**.
2. Select **BBP™31** printer from the list of products.
3. See *“Installing Software Upgrades”* on page 7-6 for instructions on upgrading the software on your printer.

Installing Software Upgrades



Upgrade from a PC

Use this procedure to upgrade your printer to a new version.

To upgrade:

1. Before installing, verify the following:
 - Upgrade Utility is available on your PC or via www.bradyid.com/support.
 - **USB cable** is connected from your **BBP™31 Printer** to your PC.
 - Printer is **ON**.

Note: If the printer driver has not been installed on your PC, you will be prompted to install the printer driver before continuing.

2. On the printer, press **Menu** .
3. In the menu list, select **More Tools** .
4. Select **Upgrade from a PC** .

Note: If there are unsaved changes in the currently active file, the system will prompt you to save the file before continuing with the upgrade.

5. On the PC, launch the upgrade utility.
6. In the *Welcome* dialog, select **Next**.
7. In the *Select your printer* dialog, select your **BBP™31 Printer**.

Note: If your printer does not have enough free space, you will be prompted to install a USB Flash Drive with at least 64MB of free space.

8. In the *Version Confirmation* dialog, select **Go** to accept the upgrade or **Cancel** to exit.

Note: The printer restarts automatically after the upgrade is complete.

9. In the *Success* dialog, click **Finish**.

Upgrade from USB Flash Drive

Use this procedure to upgrade the firmware or software from a USB flash drive that has the upgrade on it. The system will support only one USB device at a time.

To upgrade software from a USB flash drive :



CAUTION!

Do not interrupt power during an upgrade from a USB flash drive .

1. Connect the USB flash drive to any available USB port on the printer.
2. Press **Menu** .
3. In the menu list, select **More Tools** .
4. Select **Upgrade from USB drive** .

Note: If there are unsaved changes in the currently active file, the system will prompt you to save the file before continuing with the upgrade. Select **Yes**, **No** or **Cancel**.

5. At the prompt to continue with the upgrade, select **Yes**. The printer will go into upgrade mode and restart after the upgrade is complete.



8 Maintenance

Printer Maintenance

Removing Power and Media from Printer

Before performing any maintenance procedure that involves opening the enclosure cover, you should remove the power and media from the printer.

To remove printer power and media:

1. Remove the power plug [1] from the printer.



2. Open the enclosure cover (opens from left).



Printer Maintenance

Removing Power and Media from Printer

3. Release the latch on the ribbon cover [2] and swing open.
4. Release the ribbon cartridge latch [3] and lift the ribbon cartridge up and out.

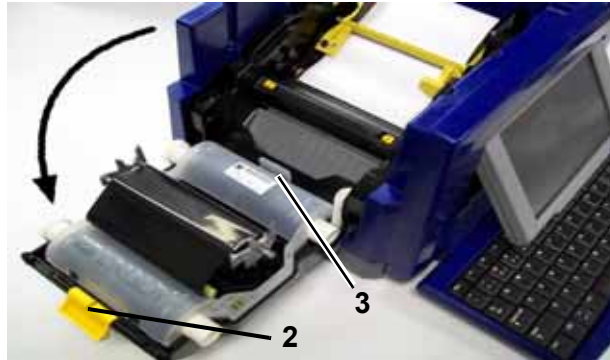

5. Move yellow media wiper [3] to far right (when facing display).
6. Move yellow media guides [4] to full-open.
7. Remove media cartridge from the slots of media holder [5].

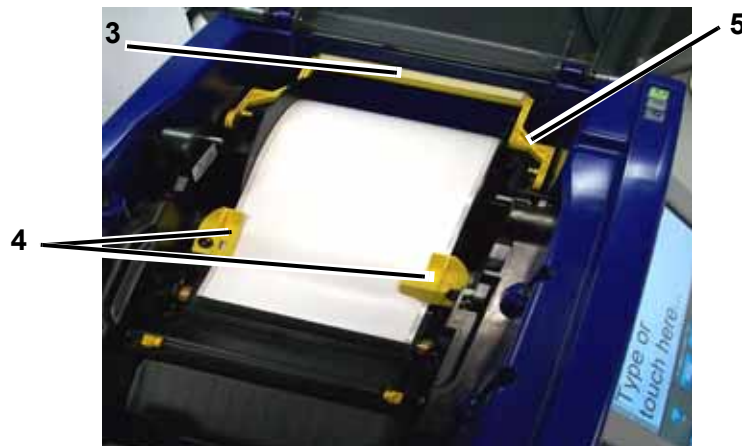

Cleaning the Printer

Cleaning Residue from Printer and Keyboard

Whenever performing any maintenance on the printer, you should also clean any residue caused by the media.

Materials Required

- Compressed Air Bottle, purchased locally (e.g., HOSA AIR-464 Gear Duster)
- Lint-free Cloth
- Isopropyl Alcohol
- Safety Glasses

To clean residue from the printer:



CAUTION!

Always wear safety glasses when using compressed air.

1. Remove power and media from the printer (see *“Removing Power and Media from Printer”* on page 8-1).
2. With safety glasses on, spray compressed air on any parts of the printer and keyboard that have built-up residue.

Note: If compressed air is not available, use a lint-free cloth lightly moistened with isopropyl alcohol and wipe off residue.

3. If necessary, use a moistened, lint-free cloth to clean the keyboard keys.
4. Replace the ribbon and tape.
5. Close all covers and plug in the power cord.

Cleaning the Touch Screen

Materials Required

- Lint-free Cloth, non-abrasive
- Isopropyl Alcohol
 - or -
- Pre-moistened Cloth (appropriate for cleaning PC screens)

To clean the touch screen:

Note: Normal cleaners with ammonia, soaps, or any acids can damage the screen. Use only a lint-free cloth dampened with isopropyl alcohol.

1. Lightly moisten a lint-free cloth with isopropyl alcohol, or use a pre-moistened cloth suitable for cleaning a PC screen.
2. Gently rub the damp cloth across the screen until all of the residue is removed.

Cleaning the Cutter Blade

Note: When cleaning the cutter, you should also clean the media and cutter sensors.

Materials Required

- BBP31 Cleaning Kit (Cat # B31-CCT)
- Isopropyl Alcohol
- Cutter Cleaning Tool (included in cleaning kit)

To clean the cutter:

1. Remove power and media from the printer (see *Removing Power and Media from Printer* on page 1).
2. Squeeze the two yellow cutter tabs [6] to release the cutter. The cutter mechanism and exit chute [7] will slide down behind the ribbon cover.

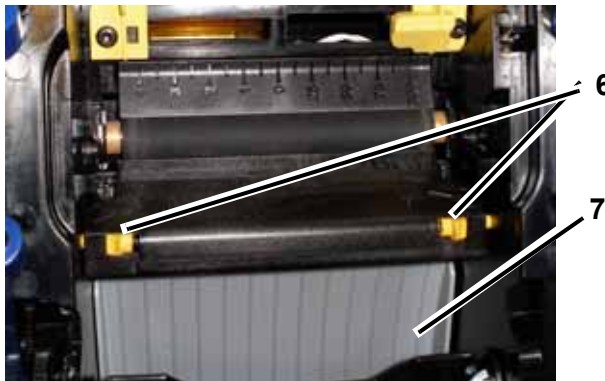

3. Fill the plastic bottle from the cleaning kit with isopropyl alcohol.

Printer Maintenance

Cleaning the Printer

4. Clean metal cutting blade [8]:
 - a. If the cutting blade shows significant residue, use a flathead screwdriver or other flat-edged tool to gently scrape the residue off the cutting blade.
 - b. Moisten one of the foam swabs from the cleaning kit with the alcohol. Do not allow the alcohol to drip from the swab.
 - c. Clean cutting blade with moistened swab until all residue is removed.

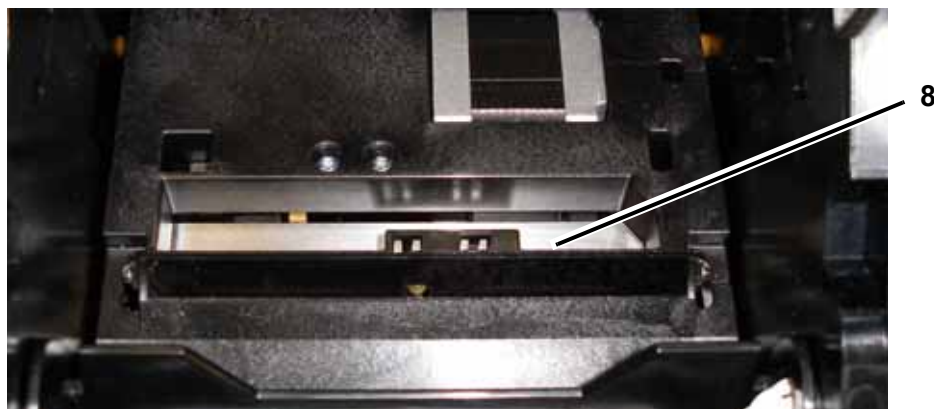

5. Close the cutting blade by pushing up on the exit chute until the cutter tabs snap into place.

Note: You may need to hold ribbon cover up slightly to access the exit chute.

6. Replace the ribbon and tape.
7. Close all covers and plug in the power cord.

Cleaning the Sensors

The media and cutter sensors are located inside the printer and may be covered with dust that results from cutting the media. The media sensor is located under the yellow media guide. The cutter sensor is located above the cutting blade and is visible only when the cutter is released.

Materials Required

- BBP31 Cleaning Kit (Cat # B31-CCT)
- Isopropyl Alcohol

To clean the sensors:

1. If necessary, remove power and media from the printer (see *Removing Power and Media from Printer* on page 1).
2. If not already released, squeeze the two yellow cutter tabs to release the cutter.
3. With a pre-moistened foam swab, gently wipe the surface of the media sensor [9] and cutter sensor [10] at the locations shown in the figure. Do not allow the alcohol to drip from the swab.

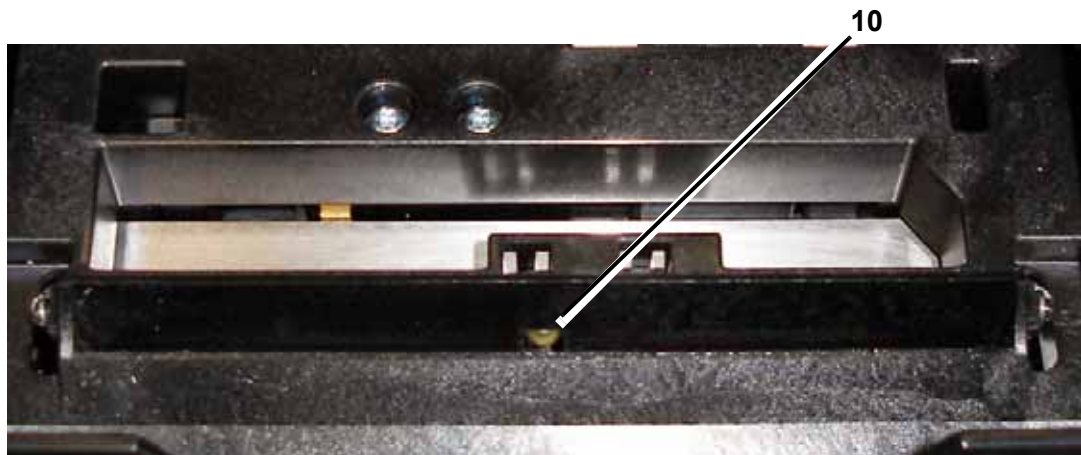
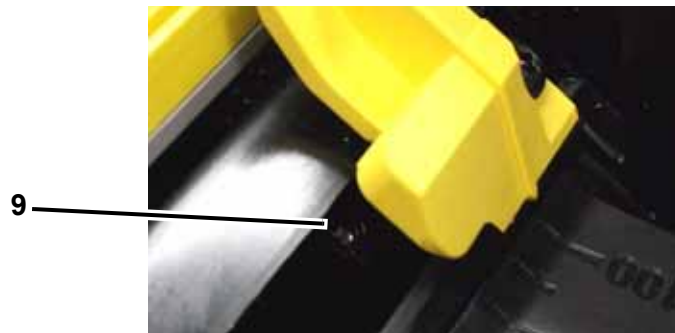

Cleaning the Cutter Blade Exit Area

This procedure cleans the cutter blade exit area and the exit chute.

Note: You should clean the exit area after cleaning the cutter blade and sensors. The cleaning swab may be damaged when cleaning the exit area.

Materials Required

- BBP31 Cleaning Kit (Cat # B31-CCT)
- Isopropyl Alcohol

To clean the exit chute:

1. If necessary, remove power and media from the printer (see *Removing Power and Media from Printer* on page 1).
2. Close the ribbon cover. It does not need to snap into place.
3. Using a pre-moistened swabs from the cleaning kit with the alcohol and clean the exit chute entrance [11] and exit chute ramp [12].

Note: To reach all areas of the exit chute, you can close the enclosure cover and tilt the printer up on its side.

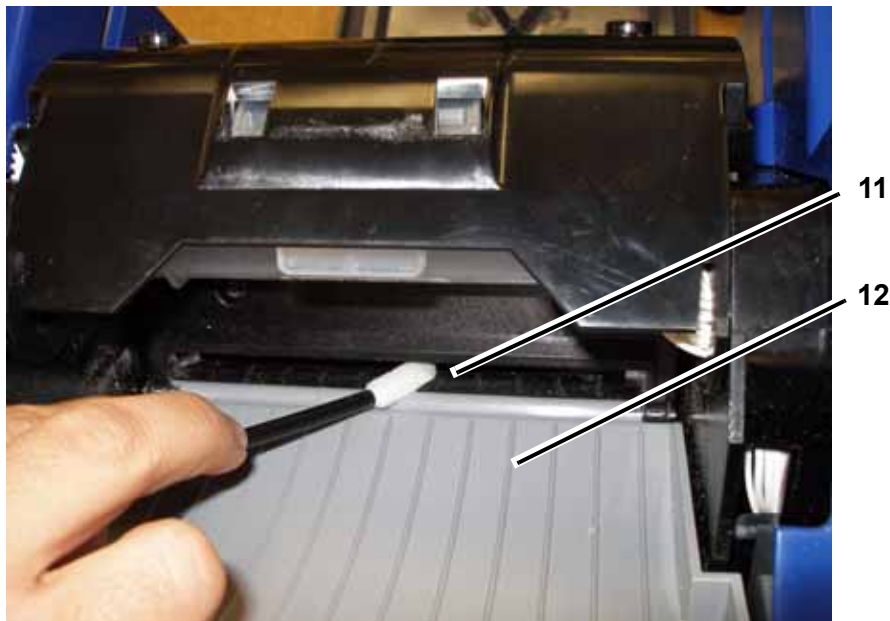

4. Replace the ribbon and tape.
5. Close all covers and plug in the power cord.

Dust Cleaning

Dust generated by media cuts can accumulate in the unit. If a significant amount of dust is built up, clean the unit using this procedure.

Materials Required

- BBP31 Cleaning Kit (Cat # B31-CCT)
- Isopropyl Alcohol
- Compressed Air Bottle, purchased locally (e.g., HOSA AIR-464 Gear Duster)

To clean dust from the unit:



CAUTION!

Always wear safety glasses when using compressed air.

1. Remove power and media from the printer (see *Removing Power and Media from Printer* on page 1).
2. Using compressed air, spray all visible areas inside the printer to remove accumulated dust.
3. Using a cloth moistened with isopropyl alcohol, wipe any remaining dust from inside the printer.
4. Wipe exterior cover and frame of printer for dirt and residue.

Cleaning the Printhead

Materials Required

- BBP31 Cleaning Kit (Cat # B31-CCT)
- Isopropyl Alcohol

To clean the printhead:

1. Remove power and media from the printer (see *Removing Power and Media from Printer* on page 1).
2. Fill the plastic bottle from the cleaning kit with isopropyl alcohol.

Note: Do not rub the swab over the bronze-colored area of the printhead.

3. Moisten one of the foam swabs from the cleaning kit with the alcohol and gently rub across the green and black area of the printhead [13].



CAUTION!

Use only the materials supplied in the cleaning kit. Using other materials may permanently damage the printhead.



4. Replace the ribbon and tape.
5. Close all covers and plug in the power cord.

Replacing the Media Wiper

Materials Required

- BBP31 Cleaning Kit (Cat # B31-CCT)

To replace the media wiper:

1. Remove power and media from the printer (see *Removing Power and Media from Printer* on page 1).
2. Lift and hold the wiper arm while grasping the tab of the wiper insert [14].
3. Pull the tab slightly forward and then slide the wiper insert out of the wiper arm.
4. To replace the wiper, insert the lip of the wiper insert into the slot [15] of the wiper arm and slide in until the tab snaps into place.

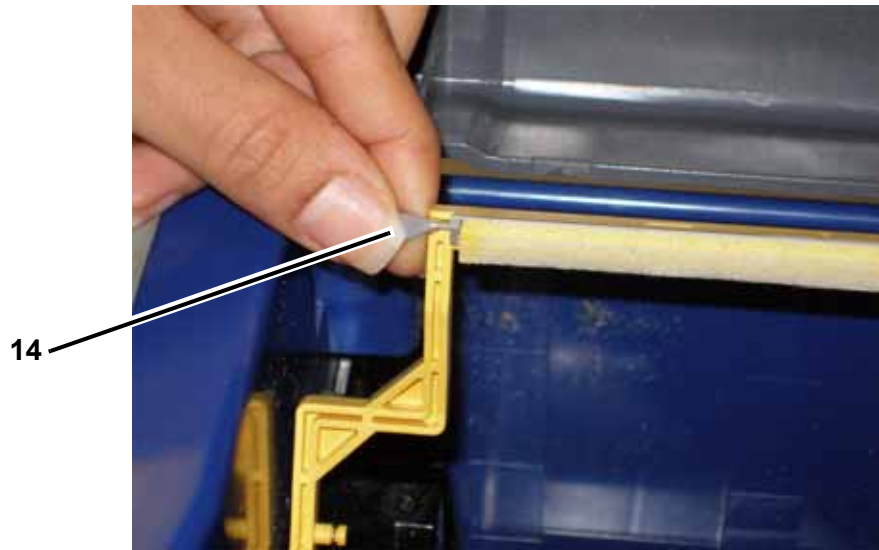

5. Replace the ribbon and tape.
6. Close all covers and plug in the power cord.

Clearing Jams

To clear jams from the printer:

1. Remove all damaged ribbon and/or media from the printer.
2. Check that there is no damage to the print head, cutter blades, sensors, etc..
3. Check whether any cleaning is needed. If cleaning is required, see *“Cleaning the Printer”* on page 8-3 for details.
4. Reload ribbon and media and clear all error messages.

9 Troubleshooting

Messages

The **BBP™31 Sign & Label Printer** contains pictures and animations that describe (or show) what action you should take to resolve any messages or errors.

The following example is for illustration only and may not represent the exact message text.

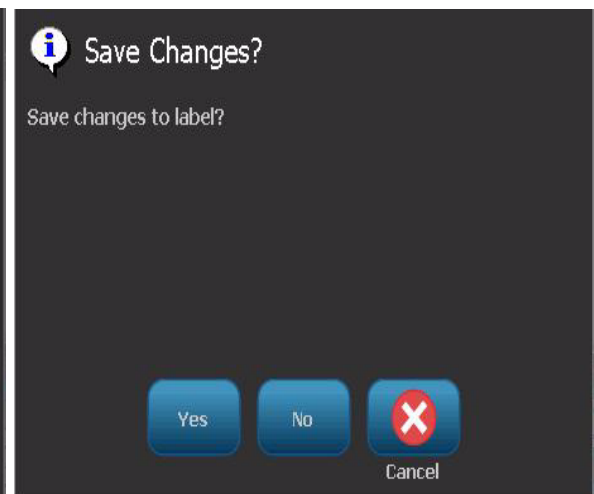
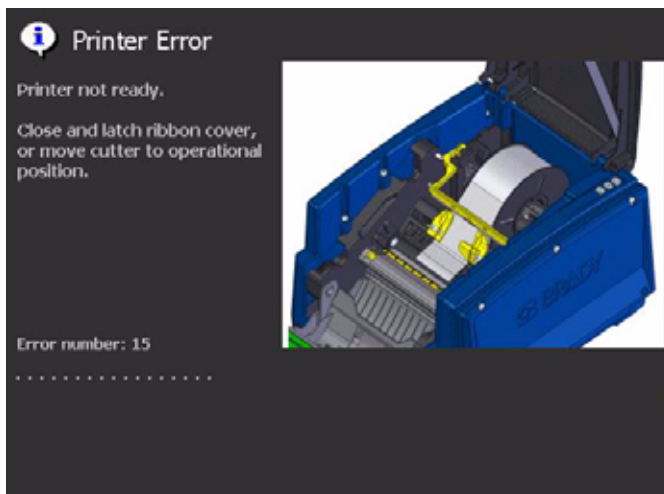

Problem Resolution

Hardware Errors

Problem Resolution

Messages indicate the problem for the task being performed and also provide a possible corrective action. The following sections provide additional information for troubleshooting printer errors.

Hardware Errors

Problem/Message	Cause	Corrective Action
Cut quality is poor.	Cutter needs cleaning.	Clean the cutter (see <i>"Cleaning the Cutter Blade"</i> on page 8-5).
Keyboard works intermittently or not at all.	One or more keys is stuck in depressed state.	Identify any keys stuck in down position. Repress key to unstick. Clean the keyboard (see <i>"Cleaning Residue from Printer and Keyboard"</i> on page 8-3).
Printer too warm. Print job was canceled. Error: 18	The printhead is too hot.	The printhead has reached maximum operating temperature. Let the printhead cool down for approximately 10 minutes, then re-initiate the print job.
Printer too cold. Print job canceled. Error: 20	The printhead has not reached operating temperature.	Normal operating range is between 50-104° F (10-40° C). Allow printer to warm up to operating temperature before printing.
Cutter does not cut. Error: 80	There is a jam in the cutter.	Clear media path at cutter. If error persists, contact Technical Support.
Printer Error Error: 85	Printer has advanced die-cut media but cannot detect the notch. Sensor may need cleaning or be failing.	Check and clear media path, then reload media. If problem persists, contact Technical Support.

Media Errors

Problem/Message	Cause	Corrective Action
Printer will not feed labels.	The leading edge of the label roll is not inserted correctly. - or - The leading edge of the label roll is uneven or torn (not a straight edge).	Install the media correctly - or - Cut a straight leading edge on the label roll.
Printer Error. Media Jam. Print job canceled. Errors: 45, 54	Media is in the media guides, but not present in leading edge sensor. - or - Media is in the leading edge sensor, but not present in the media guides. - or - Media is jammed in printer.	Reinstall the media then restart print job.
Error reading media memory cell. Reload or replace media. If error persists, contact technical support. Errors: 48, 49, 50, 51, 52	Printer cannot read the media memory cell: code incorrect [48], cannot read cell [49], data in cell is corrupted [50], cell is wrong version [51], media counter shows no media remaining [52]	Replace media. If problem persists, contact Technical Support.
Media out. Replace media and close inside printer cover. Error: 53	Tape ran out during print job. This message could also appear if the media guides move out of correct position during printing.	Reinstall media then restart the print job.
Media shifts when printing frames around label causing a slight misalignment of the frame.	Media guides not adjusted correctly, producing slack that allows the tape to shift during printing.	Adjust media guides so they are snug against the media. To make fine adjustments to the frame, see "Adjusting Print Offset" on page 5-8





Ribbon Errors

Problem/Message	Cause	Corrective Action
Ribbon out. Replace ribbon and close inside printer cover. [58]	The ribbon ran out or broke during the print job.	Replace the ribbon and restart the interrupted print job.
Error reading ribbon memory cell. Reload or replace ribbon. If error persists, contact technical support. Errors: 64, 65, 66, 67, 68	The printer cannot read the ribbon memory cell: memory cell code incorrect [64], cannot read cell [65], data in cell is corrupted [66], cell is wrong version [67], ribbon counter shows no ribbon remaining [68].	Replace the ribbon. If problem persists, contact Technical Support.

Problem Resolution

Power Errors

Power Errors

Problem/Message	Cause	Corrective Action
Printer does not power up when turned on.	Power cord has been pulled out of printer or wall socket.	Check power cord.
Screen freezes	User Interface error	<ol style="list-style-type: none"> 1. Press Power  to turn printer off. 2. Press Power  again to turn printer on. <p>If power does not shut down printer:</p> <ol style="list-style-type: none"> 3. Press and hold Power  for more than 5 seconds to reset the machine. 4. Release Power  after observing that printer has reset.

Printing Errors

Problem/Message	Cause	Corrective Action
Faint print on labels.	Ribbon not advancing correctly.	<ul style="list-style-type: none"> • Tension the ribbon by rotating the rewind spool (top spool) in a downward direction until all slack is removed. • Try another ribbon cartridge.
	Print energy might be too low.	Adjust the print-energy setting (see <i>“Adjusting Print Energy”</i> on page 5-7).
No print on the label.	The label or ribbon is not loaded correctly or out of ribbon.	Reinstall the ribbon cartridge. - or - Load a new ribbon.
Poor print quality.	Ribbon and label media are incompatible, or using an incorrect label material and ribbon combination.	Verify the correct ribbon for the label roll is loaded in the printer. - or - Change the ribbon or label combination.
	Dust or adhesives accumulated on the printhead.	Clean the printhead (see <i>“Printer Maintenance”</i> on page 8-1).
	Media wiper dirty.	Replace media wiper (see <i>“Printer Maintenance”</i> on page 8-1).
Void areas or lines appear on printed text.	Ribbon wrinkling.	<ul style="list-style-type: none"> • Tension the ribbon by rotating the rewind spool (top spool) in a downward direction until all slack is removed. • Try another ribbon cartridge.
Printer not ready. Error: 15	The ribbon cover is open or the cutter is not in operational position.	<ul style="list-style-type: none"> • Close ribbon cover. - or - • Move cutter to operational position.
Printer Error Error: 16	Ribbon cover was opened during printing.	Close ribbon cover.

A Glossary of Terms

The following are the definitions of terms that are used in this manual.

- **Alignment/Justification** page 14: Refers to how text lines are aligned in the text object. Alignment can refer to both horizontal and vertical alignment. Justification is only used in the context of horizontal alignment.
- **Autosize** page 4: When setting label length, to automatically set the label length to fit the data included on the label. Applicable for continuous media only. When setting text size, to automatically set the size of the text to the largest possible size that still fits on the label.
- **Barcode** page 5: A barcode is a series of black and white bars and white spaces with varying widths. Linear barcodes are based on bars or spaces, bar height, bar position or distance of adjacent bars.
 - **Barcode Check Character:** Identify the barcode symbology and also enable the scanner to read the data in the correct order.
 - **Barcode Start/Stop Characters:** Start/stop characters help to detect errors during the printing process. Available options are:
 - **Include Check Character:** On/off. Includes a check character in the barcode. Does not apply to all symbologies.
 - **Readable Check Character:** Displays the check character on the label if *Include Check Character* is also selected. Does not apply to all symbologies.
 - **Readable Start/stop:** Displays the start/stop character (*) on the label (does not apply to all symbologies).



- **Barcode Ratio:** The thickness ratio between a narrow bar and a wide bar. Usually, the ratio is between 2:1 and 3:1.
- **Barcode Density:** The number of characters that can be captured in a particular space, usually a linear inch. The "X" dimension determines a bar code's density. High-density bar codes have low numbers (e.g., 5 mil) and low-density bar codes have high numbers (e.g., 55 mil). When "X" is small, the area required for each character is less than when "X" is large; thus the bar code can hold more per linear inch and is said to be of higher density. The width of the barcode is influenced by the following 3 variables:
 - **Symbology:** Different symbologies have different widths of bars and spaces.
 - **Ratio of Wide to Narrow Elements:** Basically, changing the width of the narrowest bar in relation to the width of the thickest bar.
 - **Width of Narrowest Bar (x-dimension):** The most common user variable density component, is measured in thousandths of an inch or mils. Very high density barcodes can have a density as low as 3 mils.
- **Category** [pages 3-1, 4-4, 6-1, 6-2, 6-3]: Group of related items (symbols, graphics, files).
- **Condense** page 15: To compress text characters horizontally but not vertically, distorting the font. Does not change the font size.
- **Default** page 14: Predetermined action or setting. The one that will be taken or established if the user makes no changes.
- **Editor** page 4: The display area used to create and edit labels.
- **Expand** page 15: To widen text characters horizontally but not vertically, distorting the font. Does not change font size.
- **External USB** [pages 6-1, 6-3]: Removable device such as a USB flash drive .
- **Feed** page 8: Physically advance the media without printing.
- **Font Attribute** page 11: General term referring to attributes of text characters. Includes bold, italic, underline, size, superscript, subscript.
- **Font Size** page 12: Size of characters, often measured in "points" although sometimes in inches or mm.
- **Frame** page 29: A printed outline around the label or portion of the label.
- **Function:** An action or operation. Often used on a keypad key to access secondary operations from other keys.
- **Graphic:** An image or visual representation of an object. Any non-photo image or (non-text) symbol.
- **Horizontal Offset** page 8: Shifts the image (printed portion of the label) to the right or left.
- **Internal Memory** page 1: Memory built into the device used for permanent storage of files, graphics, fonts, templates, etc.
- **Key:** Physical component, typically on keyboard. Used for data entry and navigation.

- **Keystrokes** page 16: A combination of keys that when typed together result in a special or accented character. Keystroke types are:
 - **Alt Gr** (Alternative Graphic): A modifier key used to access alternate characters, represented on keys with a third or fourth symbol on the right side. Key accessed also depends on the state of the “Caps Lock” key and the type of toggle it performs.
 - **Alt Gr Lock**: A key that toggles the keyboard between access to Alt Gr and non-Alt Gr mode for specific keys.
 - **Caps Lock**: A key that toggles the keyboard between upper-case and lower-case modes for all alphabetic keys, but has no affect on other keys.
 - **Shift**: A modifier key used to access alternate “upper” characters on keys. Key accessed also depends on the state of the “Caps Lock” key and the type of toggle it performs.
 - **Shift Lock**: A version of caps lock that affects all keys as shift does.
- **Label**: The area on the display where text, graphics and barcodes are located. A discrete “page” or unit of output.
- **Media**: Substrate on which labels are printed. Includes “tape” (continuous) and “label” (die-cut).
- **Menu** page 4: A display of options that are provided to a user. There are several types of menus (e.g., pop-up, cascading, pull-down, moving-bar, etc.).
- **Mirror Print** page 5: Output that is suitable for reading in a mirror, or through the back of the label.
- **Object** page 1: Discrete data, graphic or barcode element on a label that is movable as a unit.
- **Print Energy** page 7: Defines how much heat is applied to the printhead when you are printing a label. As you print, heat applied to the printhead elements causes the ink to transfer to the label material as it passes under the printhead. The higher the print energy, the more ink is transferred to the label (i.e., the higher the heat on the heat element). Therefore, if your printing is spotty, you may want to increase the print energy to make sure more of the ribbon ink transfers to the label. However, if your ribbon is sticking or tearing during printing, the heat energy may be too high and should be reduced.
- **Print Offset** page 8: A value that will move the image from its “nominal” position slightly in one direction or another. Adjust Offset is typically used to do a fine adjustment of the printed image on a die-cut label, or to move the image slightly closer or further from the edge of a continuous supply.
- **Proportional Sizing** page 26: Uniform scaling of an object or text. Object maintains its size in both the horizontal and vertical direction.
- **Non-proportional Sizing** page 27: Non-uniform scaling of an object or text. Object size is distorted in the direction being sized.

- **Reverse Print** page 15: Attribute applied to an object where the foreground and background colors are switched.
- **Rotate** page 30: Turning the label data some number of degrees on the label (the printer supports 90, 180, 270 degree rotation only).
- **Screen**: A unit of software content to show on the display (could also be called a page or a window). Not the physical display itself.
- **Sequence/Serialization/Serial** page 31: Generating a series of alpha or numeric characters for subsequent labels. Also called variable data.
- **Sizing Handles** page 27: Small arrows that appear at the corner (proportional sizing) and sides (non-proportional sizing) of an object.
- **Supply**: Includes ribbon and media or both.
- **Template** page 1: Label with predefined content areas or data placeholders.
- **Undo** page 2: Restores the last editing operation. For example, if a segment of text was deleted or changed, performing an undo will restore the original text.
- **USB Device** (Universal Serial Bus) [pages 2-12, 7-6]: A plug-and-play interface between a computer and other devices. A USB device can be a Type B cable that connects from the PC to a device (e.g., BBP31™ printer), or a small, portable storage device (e.g., flash drive).



USB Flash Drive

- **Vertical Offset** page 8: Shifts the image (printed portion of the label) up or down.
- **Vertical Text** page 14: Text characters oriented one above the next, so subsequent characters appear below preceding characters.
- **Wizard** page 12: Series of prompts guiding user through specific action(s).

B Character Mapping & Keyboard Layouts

Keyboard configurations vary by region. See “*Character Mapping*” on page B-1 for a list of accent characters available for each keyboard configuration. See “*Keyboard Layouts*” on page B-4 for a graphical layout of the keyboard configurations.

When used in combination with the <Shift> and <AltGr> keys, the keyboards support multiple characters. The position in which the character appears on a keycap indicates which combination of keystrokes to use to access the character.

For a complete description of how to use the special characters, see “*Entering Special Characters*” on page 4-18.

Character Mapping

The following are the accent keys that are available for each of the keyboard layouts. To access the keys, just press the key and then the character (not simultaneously).

Americas QWERTY

Accent	Characters Affected
´	A, a, E, e, I, i, O, o, U, u
ˆ	A, a, E, e, I, i, O, o, U, u, Y, y
^	A, a, E, e, I, i, O, o, U, u
~	N, n, O, o
¨	A, a, E, e, O, o, U, u
¸	C, c, K, k, G, g, N, n, L, l, R, r, S, s, T, t

Character Mapping

European AZERTY

European AZERTY

Accent	Characters Affected
`	A, a, E, e, I, i, O, o, U, u
´	A, a, E, e, I, i, O, o, U, u, Y, y, C, c, S, s, N, n
^	A, a, E, e, I, i, O, o, U, u
~	N, n, O, o, A, a
¨	A, a, E, e, O, o, U, u
ˇ	S, s, Z, z, C, c, T, t, N, n, E, e, R, r
˘	A, a, G, g
“	U, u, O, o
°	A, a, U, u
ˉ	A, a, E, e, I, i, U, u
ˆ	E, e, Z, z, C, c

European QWERTZ

Accent	Characters Affected
`	A, a, E, e, I, i, O, o, U, u
´	A, a, E, e, I, i, O, o, U, u, Y, y, C, c, S, s, Y, y, N, n
^	A, a, E, e, I, i, O, o, U, u
~	N, n, O, o, A, a
¨	A, a, E, e, O, o, U, u
ˇ	S, s, Z, z, C, c, T, t, N, n, E, e, R, r
˘	A, a, G, g
“	U, u, O, o
°	A, a, U, u
ˉ	A, a, E, e, I, i, U, u
ˆ	E, e, Z, z, C, c

European QWERTY

Accent	Characters Affected
`	A, a, E, e, I, i, O, o, U, u
´	A, a, E, e, I, i, O, o, U, u, Y, y, S, s, Z, z, C, c, N, n
^	A, a, E, e, I, i, O, o, U, u
~	N, n, O, o, A, a
¨	A, a, E, e, O, o, U, u
ˇ	S, s, Z, z, C, c, T, t, N, n, E, e, R, r
˘	A, a, G, g
“	U, u, O, o
°	A, a, U, u
ˉ	A, a, E, e, I, i, U, u
ˆ	E, e, Z, z, C, c

European Cyrillic

Accent	Characters Affected
`	A, a, E, e, I, i, O, o, U, u

Keyboard Layouts

The following figures show the supported keyboard layouts for each of the configurations.

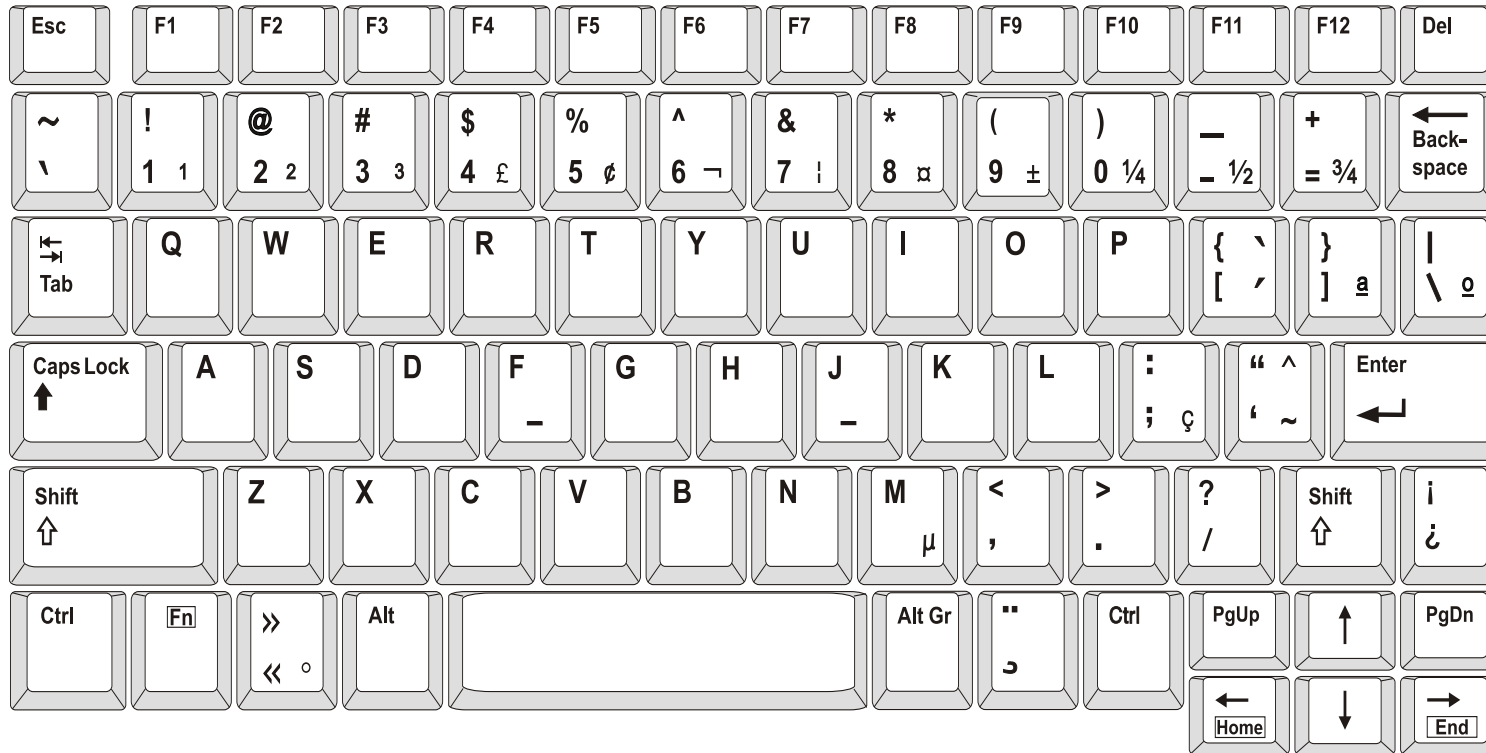

Figure 3. QWERTY - America's Keyboard Configuration

Keyboard Layouts

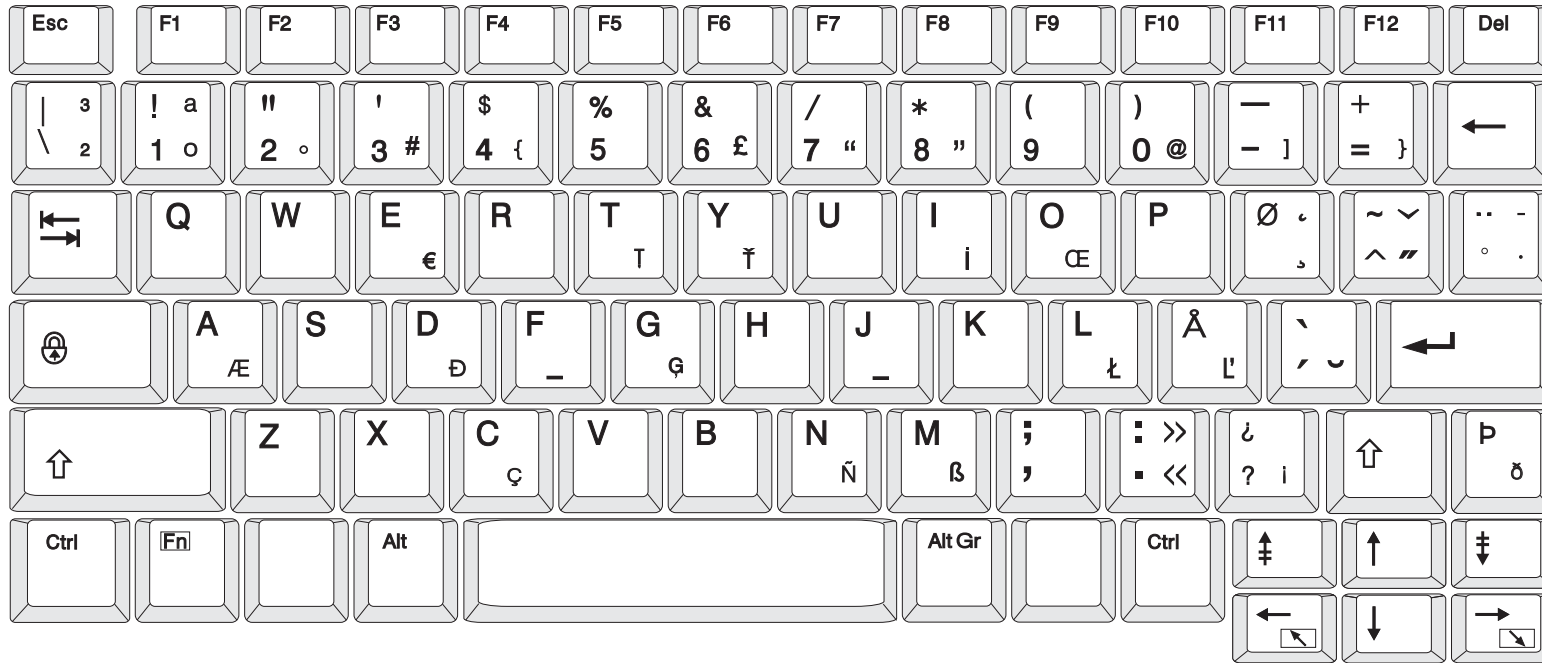

Figure 4. QWERTY - EU Keyboard Configuration

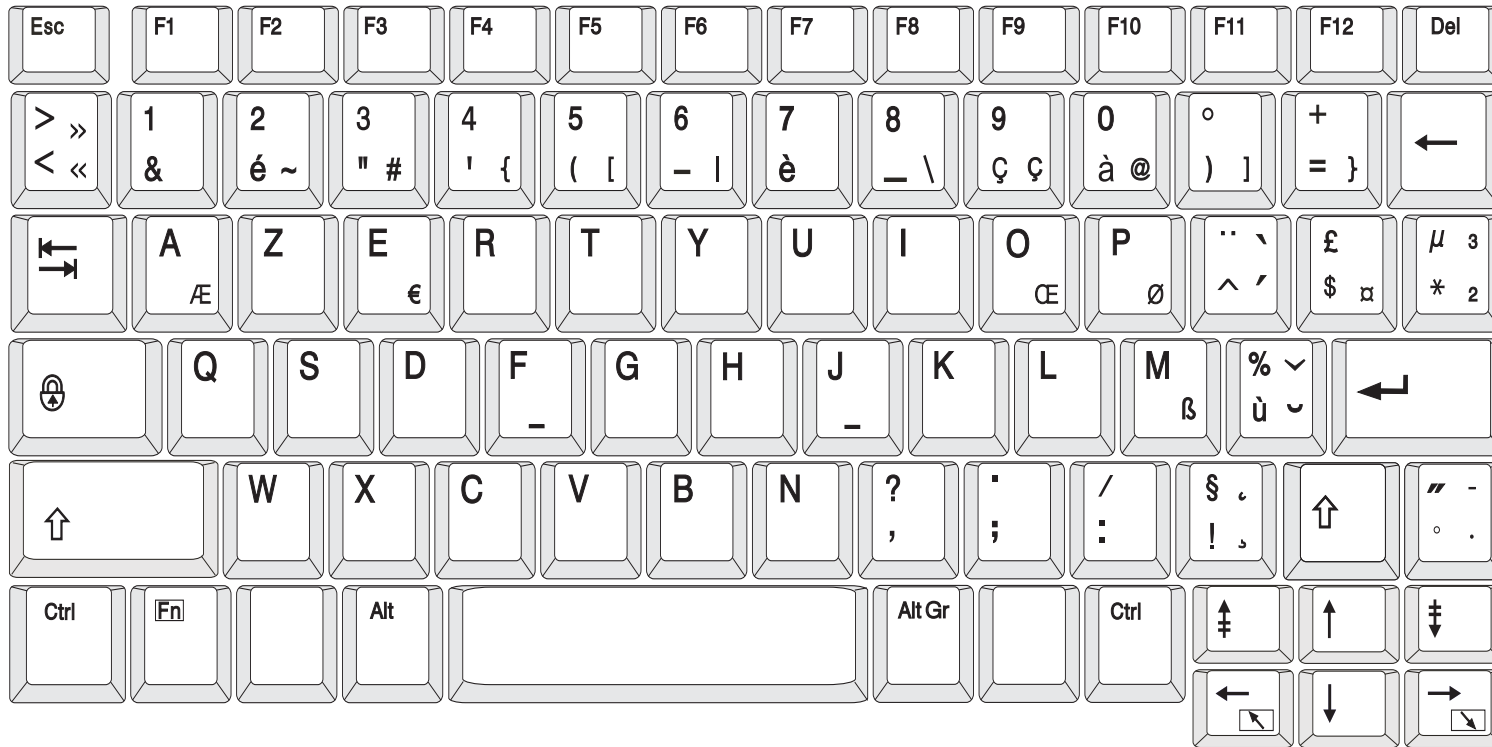

Figure 5. AZERTY - EU Keyboard Configuration

Keyboard Layouts

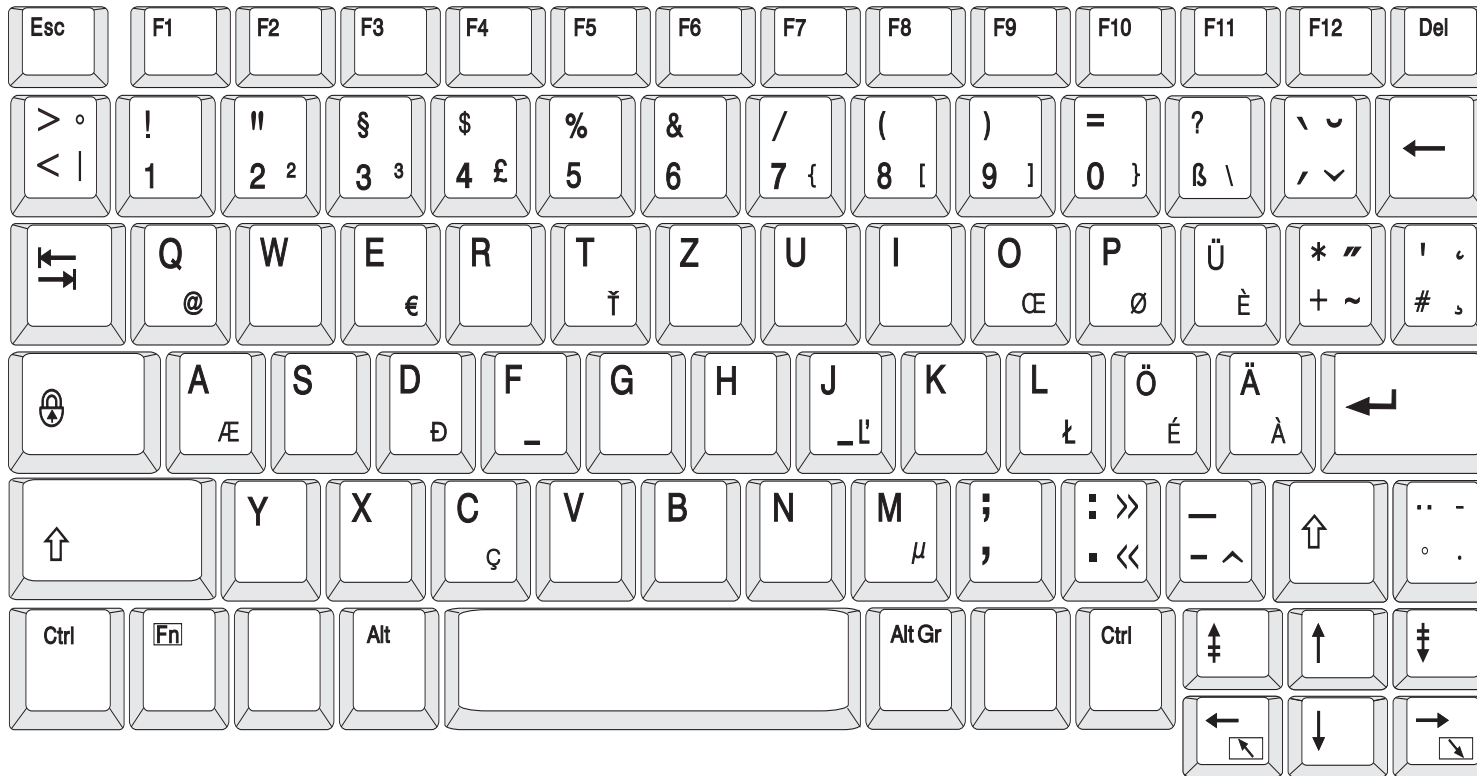

Figure 6. QWERTZ - EU Keyboard Configuration

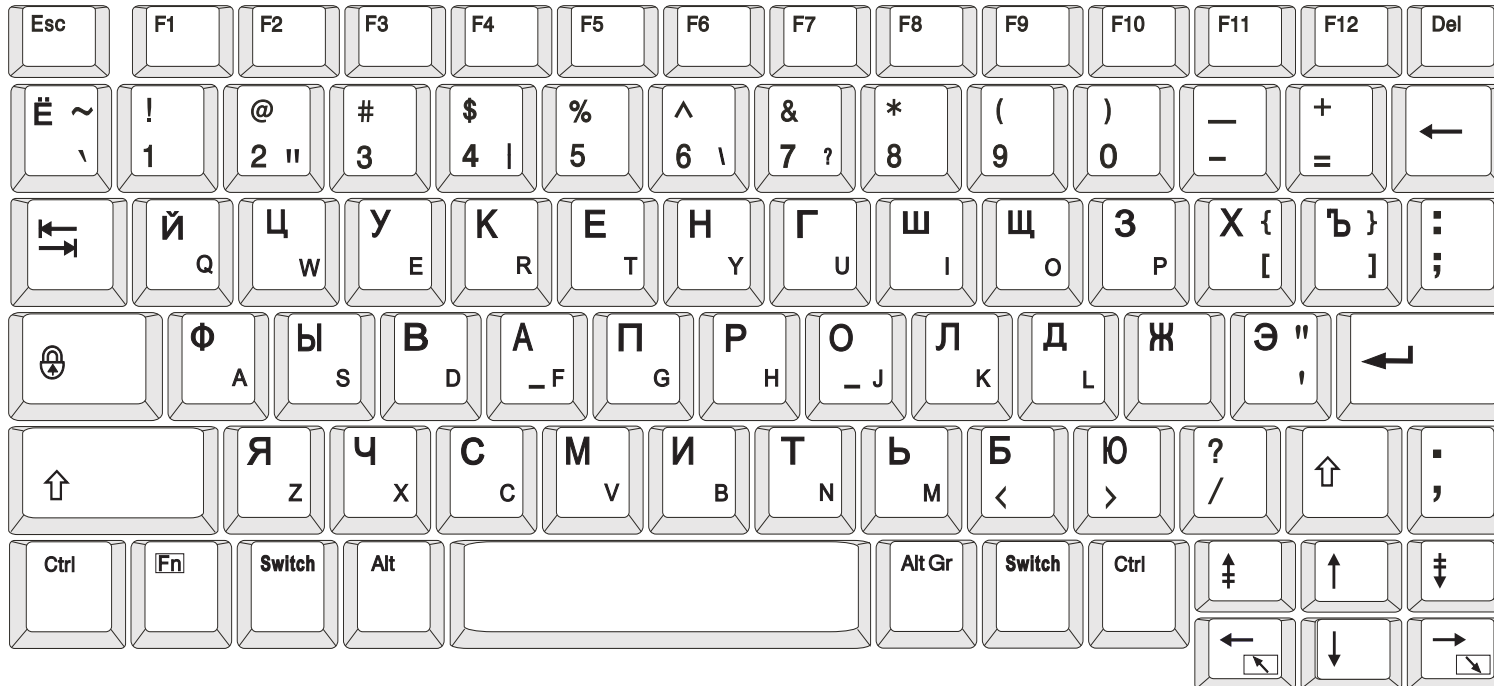

Figure 7. CYRILLIC - EU Keyboard Configuration



c Specialty Label Types

Pipe Markers

Set Up Pipe Marker Options

Setup options for Pipe Markers are different than those for standard labels. Use this procedure to set up the pipe marker color norms.

To setup pipe marker color norms:

1. From the *Home* page, select **Pipe Markers** .
- or -
Select **More Label Types**, then select **Pipe Markers**
2. From the *Pipe Marker* home page, select **Menu** .
3. Select **Setup** .

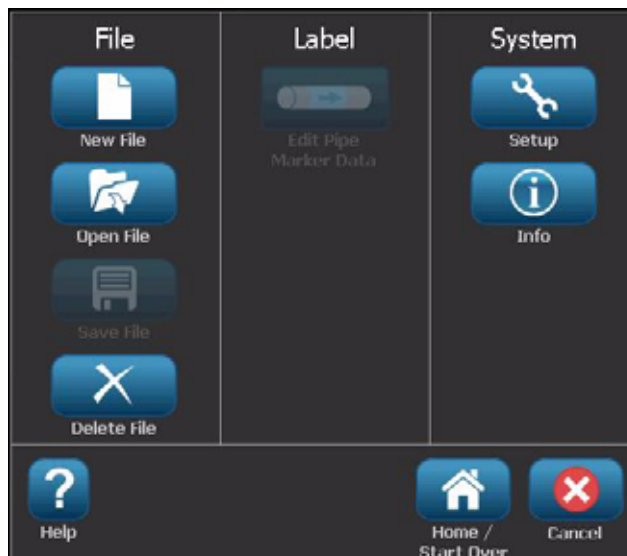

Pipe Markers
Set Up Pipe Marker Options

4. In the *Pipe Marker Preferences* dialog, choose from the following options:

Preference	Description
Printing	
Supply Saver	Prints multiple labels across the tape, if they fit (e.g., if you create a 1.125" pipe marker and have 3" media installed, it will print 2 labels across the tape). Note: Only applies if you print multiple copies of a pipe marker.
Print Label Boundary	Prints a frame around the label.
Color Norm	
ANSI/ASME 2007	American Pipe Marker standard.
CAN/CGSB	National standard of Canada.
AS1345-1995	Australia & New Zealand standard for hazardous substances.

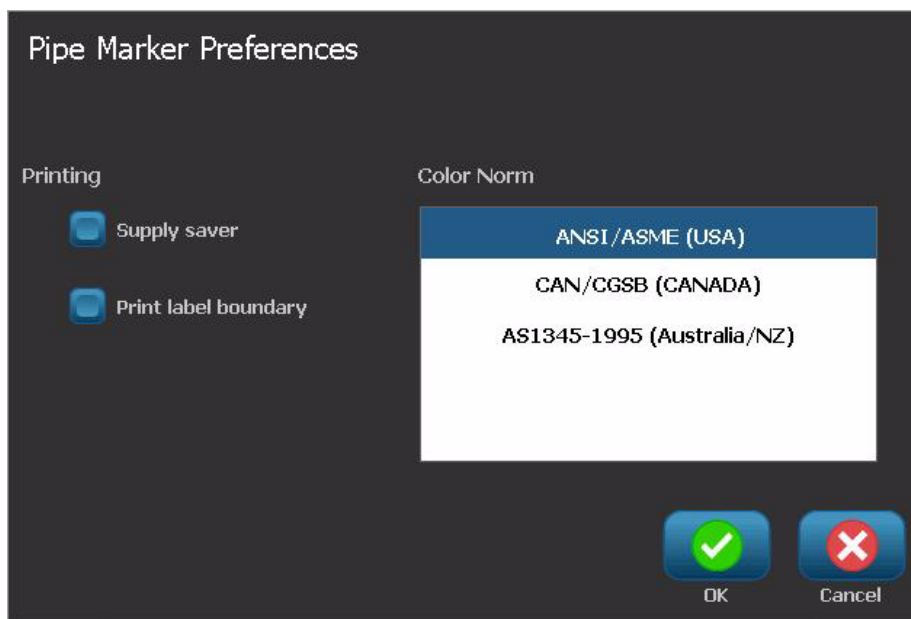



5. When done, select **OK**. Until changed, these settings will remain for all future labels.

Create Pipe Marker Labels

Use these procedures to create pipe marker labels. See “*Set Up Pipe Marker Options*” on page C-1 for an explanation on setting color norm and other Pipe Marker preferences.

To create a pipe marker label:

1. From the *Home* page, select **Pipe Markers** .
 - or -
 - Select **More Label Types**, then select **Pipe Markers**
2. From the *Pipe Marker* panel, select **Create New File** .
3. From the *Pipe Marker Style* dialog, select one of the following pipe marker label types:

Label Type	Description
Standard	Label is placed along the length of the pipe. Contents include text and graphics. Flow direction is optional.
Rollform	Similar to standard pipe markers except designed to wrap around the circumference of the pipe.
Symbol or Arrow Type	<i>Symbol</i> repeats along the entire length of the label and wraps around the circumference of the pipe. <i>Arrow</i> wraps around the pipe and indicates the direction of flow.

4. Perform the steps appropriate for your pipe marker style (see “*Creating a Standard Pipe Marker*” on page C-4, “*Creating a Rollform Pipe Marker*” on page C-7 or “*Creating a Symbol or Arrow Tape Pipe Marker*” on page C-9).

Creating a Standard Pipe Marker

To create a standard pipe marker:

1. In the *Dimensions* dialog, choose a **Tape Width** that corresponds to the diameter of your pipe, then select **Next**.
2. In the *Pipe contents* dialog, choose the type of material that will flow through the pipe, then select **Next**.

The material selected determines the pipe marker colors based on the selected color norm in the Pipe Marker setup menu.

Note: The *Ribbon/Tape* information in the dialog indicates the ribbon and tape colors that should be installed for this type of label.

3. In the *Legend* dialog, enter the text you want to appear on the label, then select **Next**.

4. To enter special characters, click  , then enter the character(s). See “*Entering Special Characters*” on page 4-18 for more detail.

If too many characters per line are used, a message will display prompting you to edit the text or lengthen the pipe marker.

Legend

Legend line 1:

Legend line 2:

Supplemental data:

Note: Multiple lines reduce text height, possibly causing the pipe marker to not comply with the standard.

←
Back

→
Next

✕
Cancel

Special Characters 

5. In the *Graphics* dialog:
 - a. Touch the graphic(s) you want to include on the label. A white line appears around the selected graphic(s) and the total number of selected graphics immediately updates. A maximum of 4 graphics are allowed.

Note: To deselect a graphic, touch the graphic again.

- b. If necessary, press **Change Category** Change Category to choose from a different set of graphics. You can select graphics from more than one category.

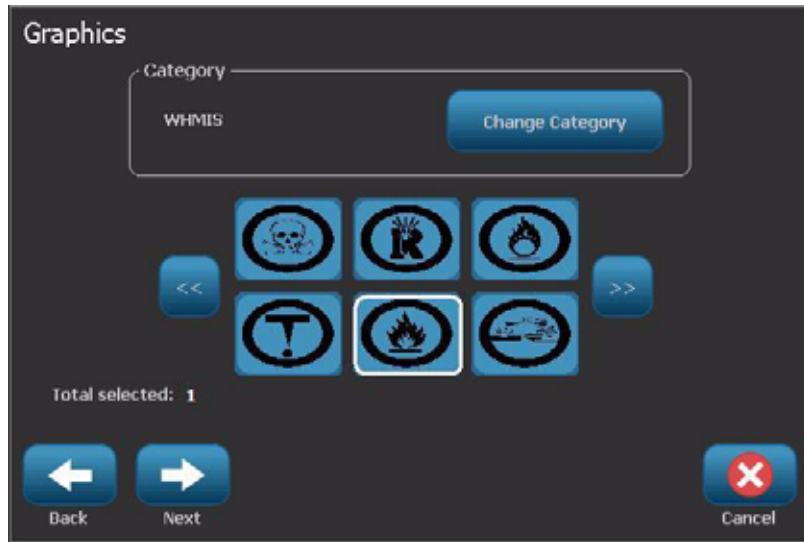



6. Select **Next**.

Pipe Markers

Create Pipe Marker Labels

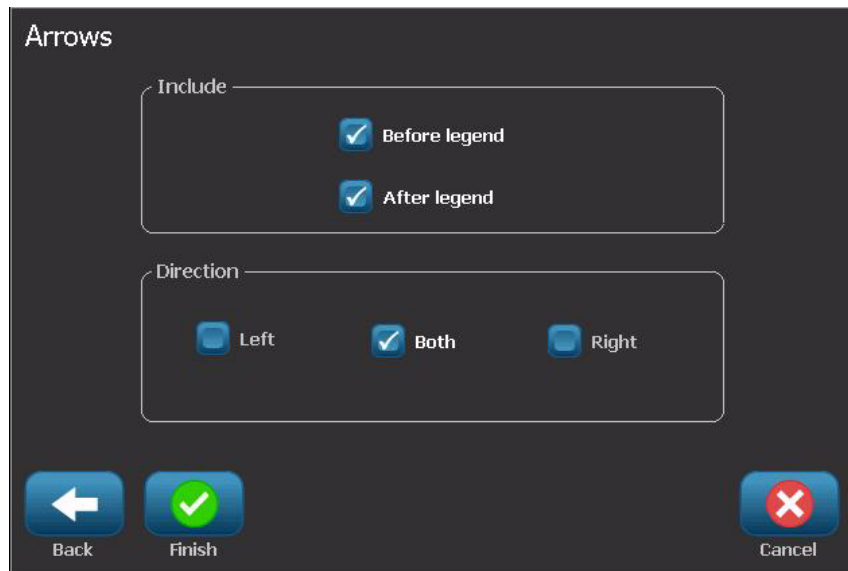
7. In the *Arrows* dialog, choose from the following options:
 - **Include:** *Before legend, After legend* (selecting both will include arrows both before and after the legend).
 - **Direction:** *Left, Right, Both*



8. Select **Finish**. The completed label will display in the Editor.
9. If desired, edit the data by selecting **Edit Pipe Marker Data**  in the *Pipe Marker* control panel. Not all fields are editable.

Note: If the length of all elements together exceeds the recommended length, you will be prompted to edit the data or lengthen the pipe marker.

10. Install the correct ribbon/tape as necessary, and print the label.

Creating a Rollform Pipe Marker

To create a rollform pipe marker:

1. In the *Dimensions* dialog, enter the pipe diameter.
2. Choose a *Tape width* from the list, then select **Next**.
3. In the *Pipe contents* dialog, choose the type of material that will flow through the pipe, then select **Next**.

The material selected determines the pipe marker colors based on the selected color norm in the Pipe Marker setup menu.

Note: The *Ribbon/Tape* information changes to indicate the ribbon and tape colors that should be installed for this label.

4. In the *Legend* dialog, enter the text you want to appear on the label, then select **Next**.

Sentences will line wrap as needed, however long, single words cannot wrap. Instead, the font will reduce to fit the whole word on the line.

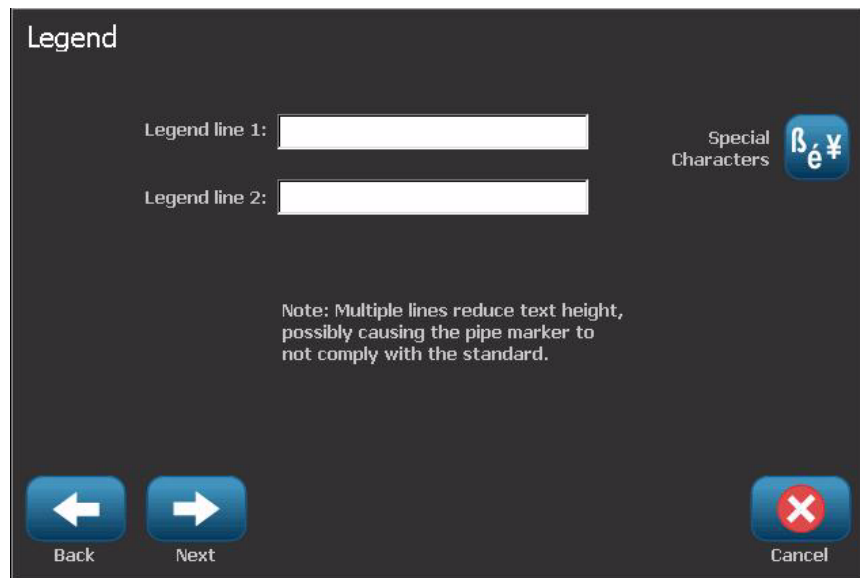

5. To enter special characters, click , then enter the character(s). See “Entering Special Characters” on page 4-18 for more detail.

Pipe Markers

Create Pipe Marker Labels

6. In the *Graphics* dialog:
 - a. Touch the graphic(s) you want to include on the label. A white line appears around the selected graphic(s) and the total number of selected graphics immediately updates. A maximum of 4 graphics are allowed.

Note: To deselect a graphic, touch the graphic again.

- b. If necessary, press **Change Category**  to choose from a different set of graphics. You can select graphics from more than one category.
7. Select **Finish**.

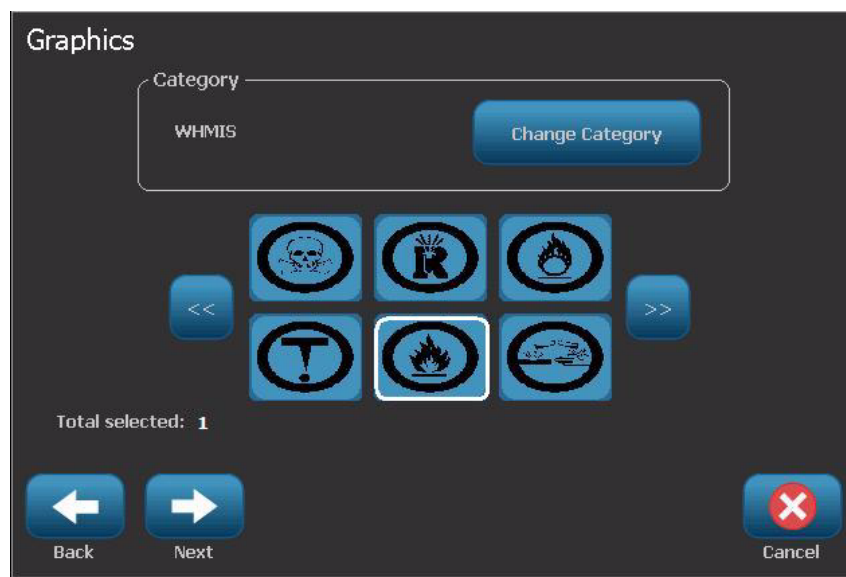

8. If desired, edit the data by selecting **Edit Pipe Marker Data**  in the *Pipe Marker* control panel. Not all fields are editable.
9. Install the correct ribbon/tape as necessary, and print the label.

Creating a Symbol or Arrow Tape Pipe Marker

To create a symbol or arrow pipe marker:

1. In the *Dimensions* dialog, enter the pipe diameter.
2. Choose a *Tape width* from the list.

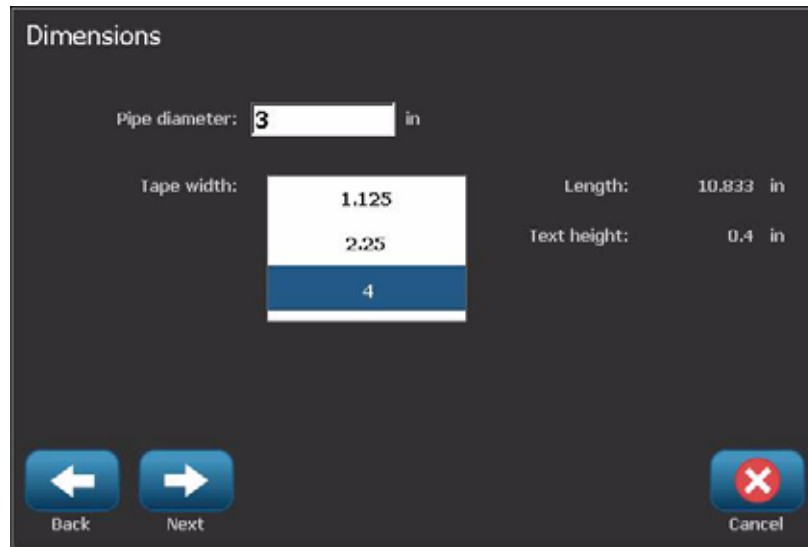

3. Select **Next**.
4. In the *Pipe contents* dialog, choose the type of material that will flow through the pipe, then select **Next**.

The material selected determines the pipe marker colors based on the selected color norm in the *Pipe Marker* setup menu.

Note: The *Ribbon/Tape* information changes to indicate the ribbon and tape colors that should be installed for this label.

5. In the *Symbol Type* dialog, choose the symbol type:
 - a. Select **Arrow**, then select **Finish**.
- or -
 - b. Select **Symbol**, then choose a category and graphic. As soon as you select a graphic, the label will be created and displayed in the *Editor*.
6. Install the correct ribbon/tape as necessary, and print the label.

Pipe Markers

Save, Open or Delete a Pipe Marker Label

Save, Open or Delete a Pipe Marker Label



You can only save, open or delete pipe marker labels from the Pipe Marker application.

To open the pipe marker application:

1. From the *Home* page, select **Pipe Markers** .
- or -
Select **More Label Types**, then select **Pipe Markers**

To save a pipe marker:

Note: This procedure assumes that a pipe marker has already been created. To create a pipe marker, see “*Create Pipe Marker Labels*” on page C-3.

1. With the pipe marker displayed in the *Pipe Marker* control panel, select **Menu**.
2. Select **Save File** .
3. Select a category, or if desired, create a new category.
4. In the *File* name field, enter a file name for the pipe marker.
5. Select **OK** . The pipe marker is saved.

To open an existing pipe marker:

1. From the *Pipe Marker* control panel, select **Open Saved File** .
2. In the *Open File* dialog, select a category.
3. Select a label. The file immediately opens in the pipe marker editor.
4. To edit the pipe marker, select **Edit Pipe Marker Data**.

To delete a pipe marker:

1. In the *Pipe Marker* control panel, select **Menu**.
2. Select **Delete File** .
3. In the *Delete File* dialog, select the category where the label is located.
4. Select the label you want to delete.
5. When prompted to delete the file, select **Yes**. Selecting *No* will cancel the operation.

QuickLabels

Creating Quick Labels

QuickLabel is an application that lets you choose from a list of predefined labels. Use this procedure to open QuickLabels.

To create a QuickLabel:

1. From the *Home* page, select **QuickLabel** .
 - or -

Select **More Label Types**, then select **QuickLabel**.

2. From the *Select Label* dialog, enter the **Label ID**, then select **OK**.



- or -

QuickLabels
Creating Quick Labels

Touch **Browse** Browse..., choose a category, then select the label you want. The label immediately opens in the *Editor*. See “*Quick Label Reference Images*” on page C-13 for examples of available quick labels.

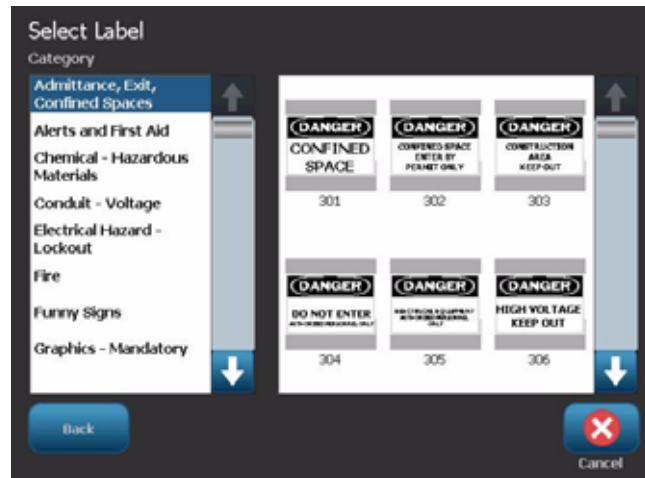

3. If desired, edit the quick label using the normal editing procedures. See “*Working with Labels*” on page 3-1 and “*Working with Objects*” on page 4-1 for more information.
4. To open, save or delete a quick label, see “*Working with Label Files*” on page 6-1.

Quick Label Reference Images

Reference the following labels when creating Quick Labels.

Admittance, Exit, Confined Spaces

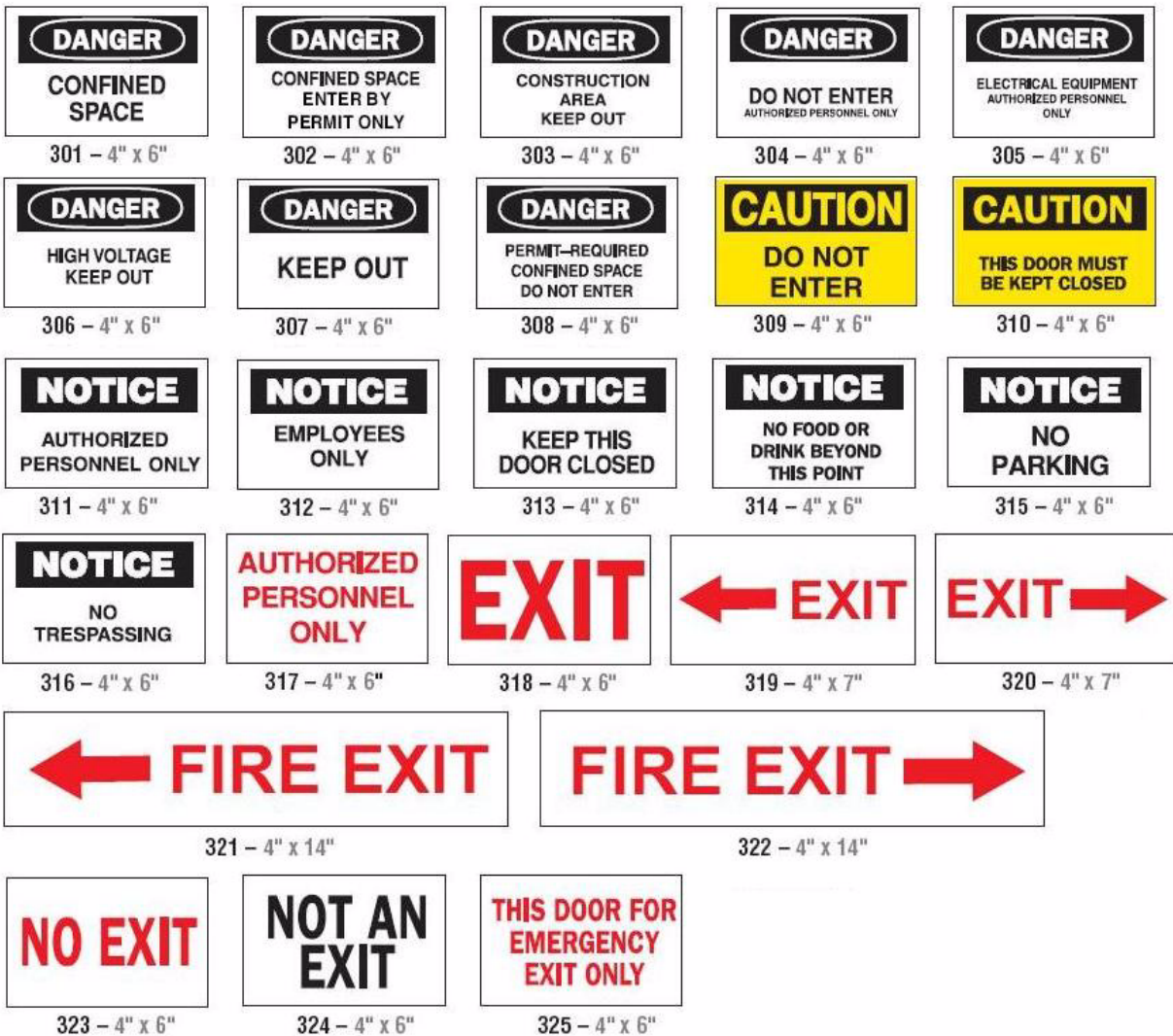

QuickLabels

Quick Label Reference Images

Alerts and First Aid



326 – 4" x 6"



327 – 4" x 6"



328 – 4" x 10"



329 – 4" x 10"



330 – 4" x 10"



331 – 4" x 6"



332 – 4" x 6"

Chemical - Hazardous Materials

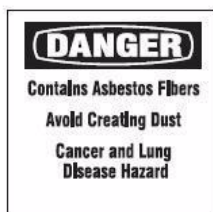

333 – 4" x 4"



334 – 4" x 6"



335 – 4" x 6"



336 – 4" x 6"

Quick Label Reference Images

Conduit - Voltage



408 – 2.25" x 9"



409 – 2.25" x 9"



410 – 2.25" x 9"



411 – 2.25" x 9"



412 – 2.25" x 9"

Electrical Hazard - Lockout



337 – 3" x 5"



338 – 3" x 5"

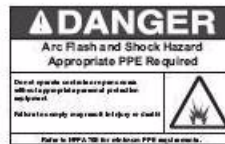

339 – 3" x 5"



340 – 3" x 5"

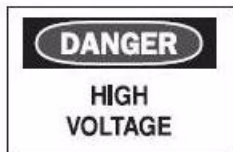

341 – 4" x 6"



342 – 6" x 4"



343 – 8" x 4"



344 – 6" x 4"



345 – 6" x 4"



350 – 8" x 4"

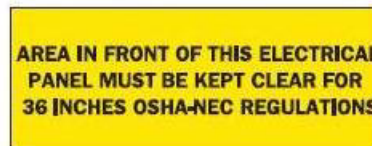

351 – 4" x 10"



352 – 3" x 5"



354 – 2.25" x 5"



355 – 2.25" x 5"



356 – 2.25" x 5"

QuickLabels

Quick Label Reference Images

Fire



361 - 4" x 14"



362 - 4" x 14"



358 - 4" x 6"



359 - 4" x 6"



363 - 4" x 6"



365 - 4" x 10"

Funny Signs



366 - 4" x 6"



367 - 4" x 6"



368 - 4" x 6"



371 - 6" x 4"



372 - 4" x 6"

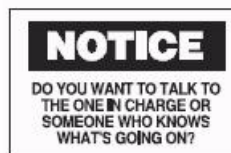

369 - 4" x 6"



370 - 4" x 6"

Graphics - Mandatory



001



002



003



004



005



006



007



008



009



010



011



012



013



014



015



016



017



018



019



020



021



022



023



024



025



026

QuickLabels

Quick Label Reference Images

Graphics - Packaging



046



047



048



049



050



051

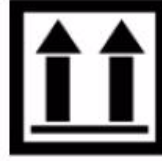

052

Graphics - PPE



027



028



029



030



031



032



033



034



035



036



037



038



039



040



041



042



043



044



045

Graphics - Prohibition



053



054



055



056



057



058



059



060



061



062



063



064



065



066



067



068



069



070



071



072



073



074



075



076



077



078



079

QuickLabels

Quick Label Reference Images

Graphics - Signal Words



080



086



087



088



089



090



091



094



095



096



099

Graphics - Warning

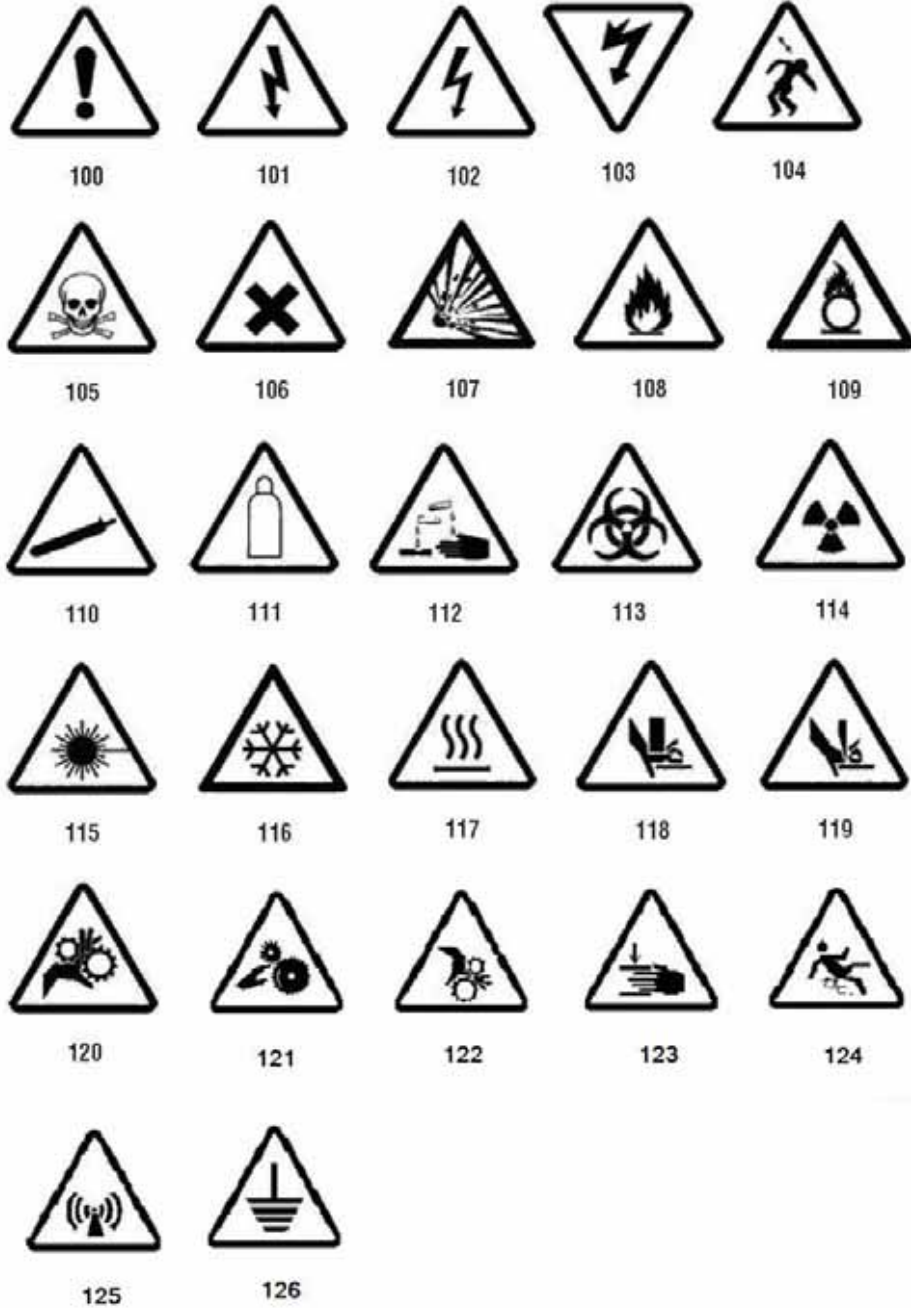

QuickLabels

Quick Label Reference Images

Inspection



402 – 0.5" x 2"



403 – 0.5" x 2"

Machine - Operational



374 – 4" x 6"



376 – 4" x 6"



378 – 4" x 6"



379 – 4" x 6"



380 – 4" x 6"



381 – 4" x 6"



382 – 4" x 6"



384 – 4" x 6"

No Smoking



385 – 4" x 6"



386 – 4" x 6"



387 – 4" x 6"



388 – 6" x 4"



389 – 4" x 6"

Pipe Marker Arrows



595



599



603



607



611



615



619



623



637



638

QuickLabels

Quick Label Reference Images

Pipe Markers



Quick Label Reference Images

MEDICAL AIR

627

MEDICAL AIR

628

MEDICAL VACUUM

629

MEDICAL VACUUM

630

NITROGEN

631

NITROGEN OXIDE

632

OXYGEN

633

AIR

639

CARBON DIOXIDE

640

CARBON DIOXIDE

641

COMPRESSED AIR

642

DEIONIZED WATER

643

HOT WATER

644

NATURAL GAS

645

VACUUM

646

QuickLabels

Quick Label Reference Images

Protective



390 – 4" x 6"



391 – 4" x 6"



392 – 4" x 6"



393 – 4" x 6"



394 – 4" x 6"



395 – 4" x 6"



396 – 4" x 6"



397 – 4" x 6"



398 – 4" x 6"

Warning Stakes



399 – 14" x 3"



400 – 14" x 3"





401 – 14" x 3"

Right to Know (RTK)

Setting RTK Preferences

From the *Right-to-Know Preferences* menu, you can choose default label settings for size and format. You can also add or delete hazards and/or organ types. Any defaults set here will stay in effect until you change them.

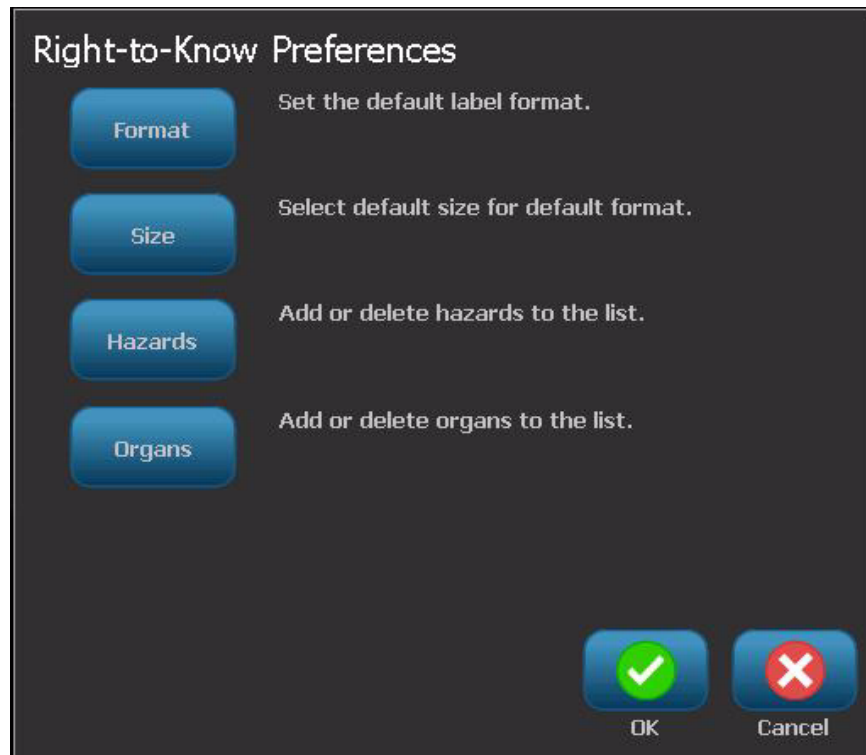

1. From the *Home* page, select **Right To Know** .
- or -
Select **More Label Types**, then select **Right To Know**.
2. From the *Right To Know* home page, select **Menu** .
3. Select **Setup** . Choose from any of the available options, then follow the instructions in “*Set Label Defaults*” on page C-28 or “*Add or Delete Hazards or Organs*” on page C-29.



Set Label Defaults

Format

To setup a default label format:

1. In the *Right-to-Know Preferences* dialog, select **Format** .
2. In the *Right-to-Know Format* dialog, choose a format type from the list. An example of the highlighted format type will display on the right side of the screen.
3. Click **OK** .
4. Click **OK**  again to close the dialog and return to the main page.

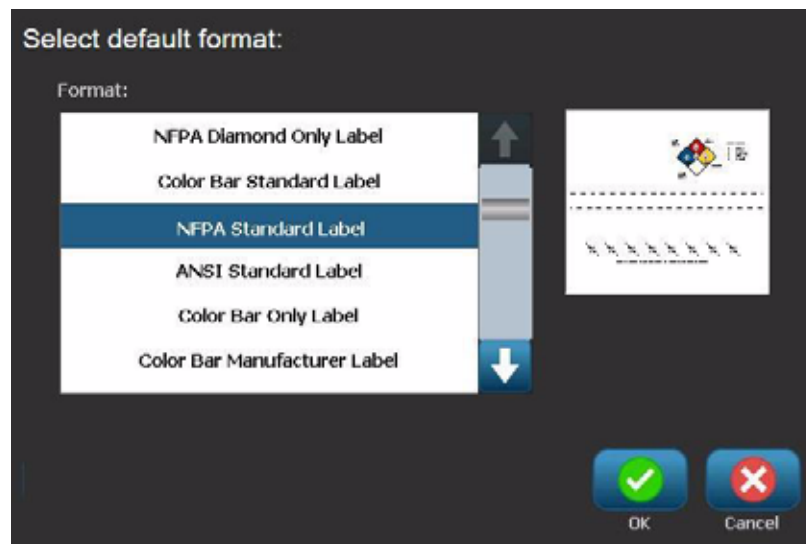



Size

To choose a default label size:

1. In the *Right-to-Know Preferences* dialog, select **Size** .
2. From the *Standard Label* options for the selected format type, choose the label size you want.



Note: The available label sizes are determined by the format type you have selected.

3. Click **OK** .
4. Click **OK**  again to close the dialog and return to the main page.

Add or Delete Hazards or Organs



Hazard Types

To add a hazard type:

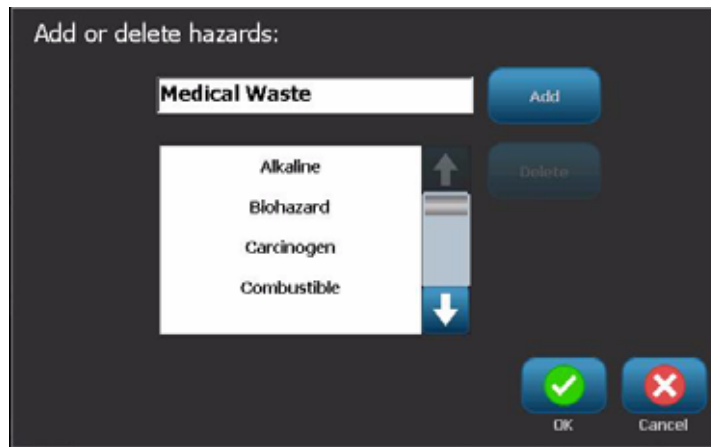
1. In the *Right-to-Know Preferences* dialog, select **Hazards** .
2. In the *Add or delete hazards* dialog, type the new hazard you want to include.
3. Select **Add** . The hazard will be added to the list.





To delete a hazard type:

1. In the *Right-to-Know Preferences* dialog, select **Hazards** .
2. In the *Add or delete hazards* drop-down list, choose the hazard you want to delete, then select **Delete** .



Organ Types

To add an organ type:

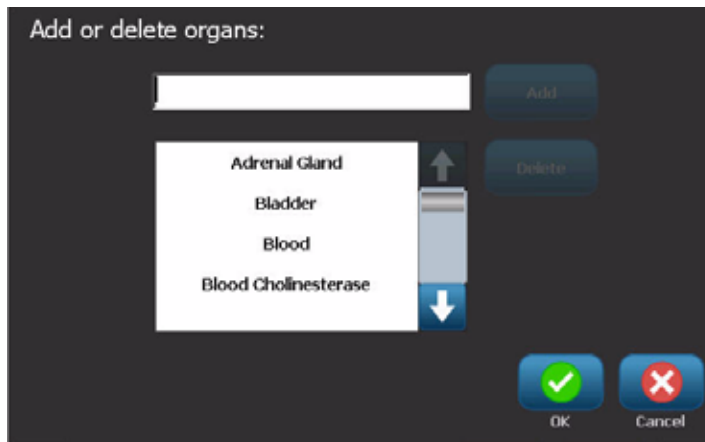
1. In the *Right-to-Know Preferences* dialog, select **Organs** .
2. In the *Add or delete organs* dialog, type the new organ you want to include.
3. Select **Add** . The organ will be added to the list.



To delete an organ type:

1. In the *Right-to-Know Preferences* dialog, select **Organs** .
2. In the *Add or delete hazards* drop-down list, choose the organ you want to delete, then select **Delete** .

Create RTK Labels

The selected label format determines the options that are available. See *Table 1. "Available RTK Formats and Options"* on page C-33 for a list of formats and options that are available from the RTK menu.

To create a new RTK label:

1. From the *Right To Know* panel, select **Create New File** .

Note: Depending on the defaults selected in the *Setup* menu, the defaults selected will vary. To change the selected defaults, see "*Setting RTK Preferences*" on page C-27.

2. Select a new label format, or click **Next** to continue with the default selection.

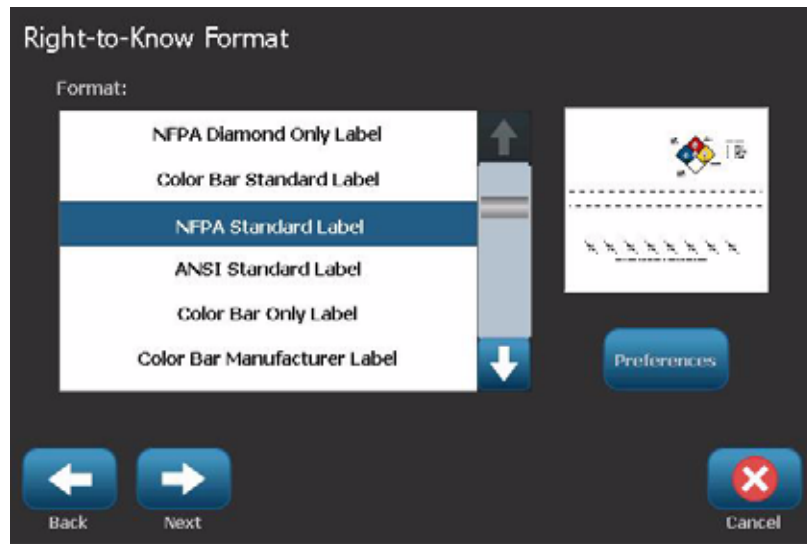

3. Select or enter data for each of the dialogs that display for your label format. The dialogs that display depend on the label format you selected.
4. When done, select **Finish**. The label is generated and displayed in the *Editor*.

Note: Before printing, install the supply that matches the label you are creating.

5. To edit or change the objects, select **Edit RTK Data** .
6. In the dialog(s) that display, select or enter the new data, then click **Next** or **Finish**.

Note: The format cannot be edited after a label has been created.

Right to Know (RTK)

Open, Save or Delete an RTK Label

Open, Save or Delete an RTK Label

You can only save, open or delete RTK labels from the Right To Know (RTK) application.

To open an existing RTK label:

1. From the *Home* page, select **Right To Know** .



- or -

Select **More Label Types**, then select **Right To Know**.

2. From the *Right To Know* control panel, select **Open Saved File** .
3. In the *Open File* dialog, choose a category.
4. Select a label. The file immediately opens in the *Editor*.

To save an RTK label:

Note: This procedure assumes that an RTK label has already been created. To create an RTK label, see “*Create RTK Labels*” on page C-31.

1. With the RTK label displayed in the *Editor*, select **Menu**.
2. Select **Save File** .
3. Select a category, or if desired, create a new category.
4. In the *File* name field, enter a file name for the RTK label.
5. Select **OK** . The RTK label is saved.

To delete an RTK label:

1. In the *Right To Know* control panel, select **Menu**.
2. Select **Delete File** .
3. In the *Delete File* dialog, choose the category where the label is located.
4. Touch the label you want to delete.
5. When prompted to delete the file, select **Yes**. Selecting **No** will cancel the operation.

Open, Save or Delete an RTK Label

Table 1. Available RTK Formats and Options

RTK Formats	Available Options*	Description
NFPA Diamond Only Color Bar Standard NFPA Standard ANSI Standard Color Bar Only Color Bar Manufacturer NFPA Manufacturer NFPA Tag - One Sided NFPA Tag - Two Sided Color BarTag - One Sided Color BarTag - Two Sided	Size	Select a label size for the chosen format.
	Chemical Name / Name	Enter the chemical description.
	Common Name	Enter a common name for the chemical.
	Health Hazard Rating	Select standard ratings ranging from none to severe, if applicable
	Fire Hazard Rating	
	Instability (reactivity) Rating	
	Specific Hazard Rating	Select specific hazard rating type, if applicable.
	CAS#/Title	Enter the chemical identification number and/or title.
	Synonym	Enter an alternate name for the chemical.
	Signal Word	Select a standard OSHA signal word (danger, warning, caution), if applicable.
	Physical & Health Hazards	Select hazards to health and/or physical body.
	Target Organs	Select organs affected. The list includes target organs for the selected chemical.
	Comments	Add relevant comments to your label.
	Graphics	Add graphic(s). Graphics are sorted by category.
	Statement of Hazard	Enter a statement of the hazard (displays in all caps on label).
	Precautionary Statements	Specify any precautions.
	Effects of Overexposure	Describe condition that will result from overexposure.
	First Aid Procedures	Provide first aid information.
	Protective Equipment	Designat protective equipment codes and manufacturers for Color Bar and NFPA labels.
	Manufacturer	Enter manufacturer of chemical, if known.
Temperature	Enter temperature that you want printed on the label.	
Date	Enter the date.	

** Available options depend on the RTK format selected.*

D Material / Ribbon Cross Reference

BBP™ 31 Material / Ribbon Cross Reference Guide					
Material		Ribbon			
		● = Recommended Δ = Acceptable			
Brady Material #	Material Description	B30-R10000 (Black, Colors)	B30-R6000 (Black)	B30-R4300 (Black)	M30-R4400-WT (White)
B-423	Polyester		●		Δ
B-427	Self-Laminating Vinyl			●	
B-438	Tamper-Evident Metallized Polyester			●	
B-509	Magnetic	●	Δ		
B-526	Phosphorescent	●	Δ		
B-549	Cold Temperature	●	Δ		
B-551	Tag Stock	●			
B-565	Metallized Polyester	●	Δ		
B-569	Hi-Performance Polyester	●	Δ		Δ
B-575	Brushed Polyester	●	Δ		
B-581	Repositional Vinyl	●	Δ		
B-584	Reflective Tape	●	Δ		Δ
B-593	Adhesvie Taped Polyester		●		Δ
B-595	Indoor/Outdoor Vinyl Tape	●	Δ		Δ
B-7563	Metallized Polyester		Δ	●	Δ
B-7589	Vinyl Tape	Δ	●		Δ
B-7591	Indoor Vinyl Tape	Δ	●		
B-7594	Polypropylene	?	?		

