

9EC SERIES - 4/10 HP

APPLICATIONS

Effluent wastewater removal, dewatering, water transfer

FEATURES

- Permanent Split Capacitor (PSC)
- Designed for continuous duty
- Energy-saving low amp draw
- 1-1/2" FNPT (38 mm) discharge
- Handles solids up to 3/4" (19 mm) diameter
- Multiple switch options for automatic operation
- 140 °F (60 °C) liquid temperature rating
- cCSAus listed



SERIES SPECIFICATIONS

Model	HP	Volts	HZ	Amps	Watts	Max. Water Temp.	GPM / Liters per Minute @ Height					Shut-Off	
							5 ft / 1.5 m	10 ft / 3 m	20 ft / 6.1 m	30 ft / 9.1 m	40 ft / 12.2 m	ft / m	PSI / Bar
9EC	4/10	115	60	7.5	800	140 °F / 60 °C	70 / 265	65 / 246	50 / 189	26 / 98	-	40 / 12.2	17.3 / 1.19
	4/10	230	60	-	-	140 °F / 60 °C	70 / 265	65 / 246	50 / 189	26 / 98	-	40 / 12.2	17.3 / 1.19

Item No.	Model	HP	Volts	Switch Type / Operation	On Level	Off Level	Cord	Weight
509804	9EC-CIA-SFS	4/10	115	Integral Float Switch	7" - 10" 18 cm - 25 cm	2" - 5" 5 cm - 13 cm	30' 9.1 m	28.5 lbs 12.93 Kg
509801	9EC-CIA-RF	4/10	115	Piggyback Float Switch	12" - 15" 30 cm - 38 cm	6" - 9" 15 cm - 23 cm	20' 6.1 m	27.5 lbs 12.47 Kg
509802	9EC-CIA-RF	4/10	115	Piggyback Float Switch	12" - 15" 30 cm - 38 cm	6" - 9" 15 cm - 23 cm	30' 9.1 m	28.5 lbs 12.93 Kg
509806	9EC-CIM	4/10	115	Manual	-	-	10' 3.0 m	27.5 lbs 12.47 Kg
509805	9EC-CIM	4/10	115	Manual	-	-	20' 6.1 m	27.5 lbs 12.47 Kg
509808	9EC-CIM	4/10	115	Manual	-	-	30' 9.1 m	28.5 lbs 12.93 Kg
509803	9EC-CIA-RF	4/10	230	Piggyback Float Switch	12" - 15" 30 cm - 38 cm	6" - 9" 15 cm - 23 cm	20' 6.1 m	27.5 lbs 12.47 Kg
509807	9EC-CIM	4/10	230	Manual	-	-	20' 6.1 m	27.5 lbs 12.47 Kg

EFFLUENT PUMPS

9EC SERIES - 4/10 HP

ENGINEERING DATA

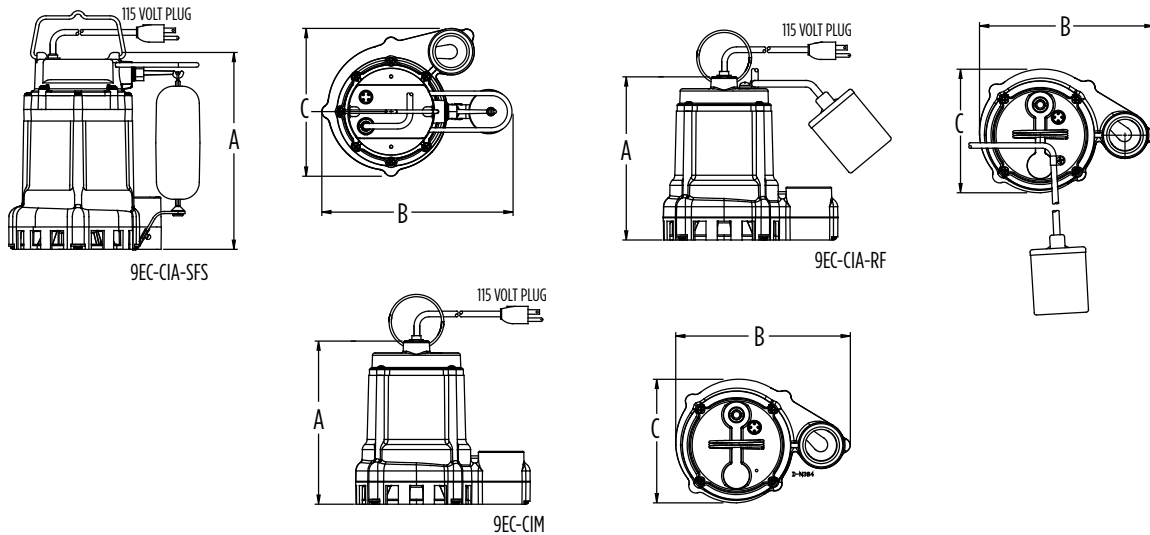

Model	A	B	C
9EC-CIA-SFS	11.8" (300 mm)	10.7" (271 mm)	8.4" (214 mm)
9EC-CIA-RF	11.0" (280 mm)	8.9" (226 mm)	8.4" (214 mm)
9EC-CIM	11.0" (280 mm)	8.9" (226 mm)	8.4" (214 mm)

PERFORMANCE DATA

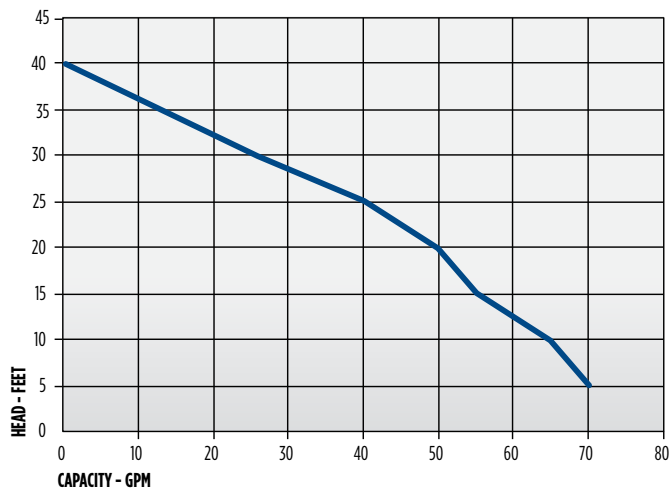

CONSTRUCTION

Cover	Epoxy-coated cast iron/ *Thermoplastic
Motor Housing	Epoxy-coated cast iron
Impeller Material	Thermoplastic elastomer
Impeller Type	Non-clog
Volute	Epoxy-coated cast iron
Motor Shaft	Steel
Mechanical Shaft Seal	Nitrile with carbon and ceramic faces
Fasteners	Stainless steel
Bearings	Upper sintered sleeve and lower ball bearing
Power Cord	SJTW **SJTOW

* On SFS models

** On 30' 9EC-CIA-RF and 9EC-CIM models