

R8070SD

# REED INSTRUMENTS

## Data Logging Sound Level Meter



## Instruction Manual

**REED Instruments**

1-877-849-2127 | [info@reedinstruments.com](mailto:info@reedinstruments.com) | [www.reedinstruments.com](http://www.reedinstruments.com)

# Table of Contents

Introduction .....	3
Product Quality.....	3
Safety .....	4
Features.....	4
Included.....	4
Specifications.....	5-6
<i>Comparison of Frequency Weightings and Tolerance Limits</i> .....	6
<i>Time Weighting (Fast &amp; Slow) Characteristics</i> .....	6
Instrument Description .....	7
Display Description .....	8
Operating Instructions.....	9-11
<i>Power ON/OFF</i> .....	9
<i>Basic Operation</i> .....	9-10
<i>Data Hold</i> .....	10
<i>Peak Hold</i> .....	10
<i>Recording Maximum and Minimum Readings</i> .....	10
<i>Backlight</i> .....	11
Setup Mode.....	11-13
<i>Setting the Time and Date (dAtE)</i> .....	11
<i>Setting Data Decimal Format (dEC)</i> .....	12
<i>Enabling/Disabling Auto Power OFF (PoFF)</i> .....	12
<i>Enabling/Disabling the Beeper Sound (bEEP)</i> .....	12
<i>Setting the Data Logging Sampling Rate (SP-t)</i> .....	12
<i>Formatting the SD Card (Sd F)</i> .....	13
<i>Checking Time and Date</i> .....	13
<i>Checking Sampling Rate</i> .....	13

*continued...*

Data Logging.....	13-17
<i>Data Recording Modes.....</i>	<i>13</i>
<i>Manual Data Logging Mode.....</i>	<i>14</i>
<i>Automatic Data Logging Mode.....</i>	<i>14-15</i>
<i>Transferring Data from the SD Memory Card to a Computer.....</i>	<i>15</i>
<i>Calibration Procedure.....</i>	<i>16</i>
<i>Data Stream Output.....</i>	<i>16</i>
<i>3.5mm Terminal to RS-232 Serial Connection.....</i>	<i>17</i>
Battery Replacement.....	17
Applications.....	17
Accessories and Replacement Parts.....	18
Frequently Asked Questions (FAQ's).....	18
Product Care.....	19
Product Warranty.....	19
Product Disposal and Recycling.....	20
Product Support.....	20

## Introduction

Thank you for purchasing your REED R8070SD Data Logging Sound Level Meter. Please read the following instructions carefully before using your instrument. By following the steps outlined in this manual your meter will provide years of reliable service.

## Product Quality

This product has been manufactured in an ISO 9001 facility and has been calibrated during the manufacturing process to meet the stated product specifications. If a certificate of calibration is required please contact the nearest authorized REED distributor or authorized Service Center. Please note an additional fee for this service will apply.

## Safety

Never attempt to repair or modify your instrument. Dismantling your product, other than for the purpose of replacing batteries, may cause damage that will not be covered under the manufacturer's warranty. Servicing should only be provided by an authorized service center.

## Features

- High accuracy of  $\pm 1.0\text{dB}$  to 1kHz meets Type 2 standards
- Triple range measurement (50dB dynamic range)
- A & C frequency weighting
- Fast & Slow time weighting
- Real time data logger with integrated SD memory card
- User selectable sampling rate from 1 to 3600 seconds
- Easy-to-read backlit LCD display
- Peak hold, Data hold and Min/Max hold
- Tripod mount for long-term monitoring
- Low battery indicator and auto shut off
- The single AC output jack (3.5mm stereo mini-plug) provides analog signals to frequency analysers, level recorders, FFT analysers, graphic recorders, etc.

## Included

- Windshield Ball
- Soft Carrying Case
- Batteries

## Specifications

Measuring Ranges:	30 to 130dB Low: 30 to 80dB Med: 50 to 100dB High: 80 to 130dB Full: 30 to 130dB
Dynamic Range:	50dB (in each range)
Accuracy:	31.5Hz $\pm$ 3.0dB, 63Hz $\pm$ 2.0dB, 125Hz $\pm$ 1.5dB, 250Hz $\pm$ 1.5dB, 500Hz $\pm$ 1.5dB, 1kHz $\pm$ 1.0dB, 2kHz $\pm$ 2.0dB, 4kHz $\pm$ 3.0dB, 8kHz $\pm$ 5.0dB
Resolution:	0.1dB
Response Time:	500ms
Frequency Range:	31.5Hz to 8kHz
Frequency Weighting:	A, C
Time Weighting:	Fast/Slow (125ms and 1s)
Microphone:	0.5" (12.7mm) electret condenser
Display:	4-digit LCD
Backlit Display:	Yes
Data Hold:	Yes
Min:	Yes
Max:	Yes
Alarm Indicators:	Under and Over (visual on-screen)
Datalogging Capabilities:	Yes
Real-Time Clock and Date Stamp:	Yes
Selectable Sampling Rate:	Yes (1, 2, 5, 10, 30, 60, 120, 300, 600, 1800, 3600 seconds)
External Memory:	Yes, expandable up to 16GB with SD card (optional)
Auto Shut-Off:	Yes (after 10 minutes/off)
Kick Stand:	Yes
Tripod Mountable:	Yes
Low Battery Indicator:	Yes

*continued...*

**REED Instruments**

1-877-849-2127 | [info@reedinstruments.com](mailto:info@reedinstruments.com) | [www.reedinstruments.com](http://www.reedinstruments.com)

Power Supply:	6 x AA batteries or AC Adapter (optional)
Data Output:	Yes (RS-232)
AC Output Signal:	0.5Vrms (full scale of selected range)
AC Output Impedance:	600 ohms
AC Output Terminal:	3.5mm Stereo Jack
Battery Life:	Sampling Time Dependent
Product Certifications:	CE, IEC 61672-1-2013, Class 2
Operating Temperature:	32 to 122°F (0 to 50°C)
Storage Temperature:	14 to 140°F (-10 to 60°C)
Operating Humidity Range:	Less than 85% RH
Dimensions:	9.7 x 2.7 x 1.8" (245 x 68 x 45mm)
Weight:	0.7lbs (320g)

### *Comparison of Frequency Weightings and Tolerance Limits*

Frequency Hz	A Weighting Characteristics	C Weighting Characteristics	Tolerance (IEC 61672 class 2)
31.5	-39.4dB	-3dB	±3.0dB
63	-26.2dB	-0.8dB	±2.0dB
125	-16.1dB	-0.2dB	±1.5dB
250	-8.6dB	0dB	±1.5dB
500	-3.2dB	0dB	±1.5dB
1K	0dB	0dB	±1.0dB
2K	+1.2dB	-0.2dB	±2.0dB
4K	+1dB	-0.8dB	±3.0dB
8K	-1.1dB	-3dB	±5.0dB

### *Time Weighting (Fast & Slow) Characteristics*

Time Weighting Characteristics	Max Response Reference Continuous Signal	Tolerance (IEC 61672 class 2)
F (Fast)	-1.0dB	±1.0dB
S (Slow)	-4.1dB	±1.0dB

## Instrument Description

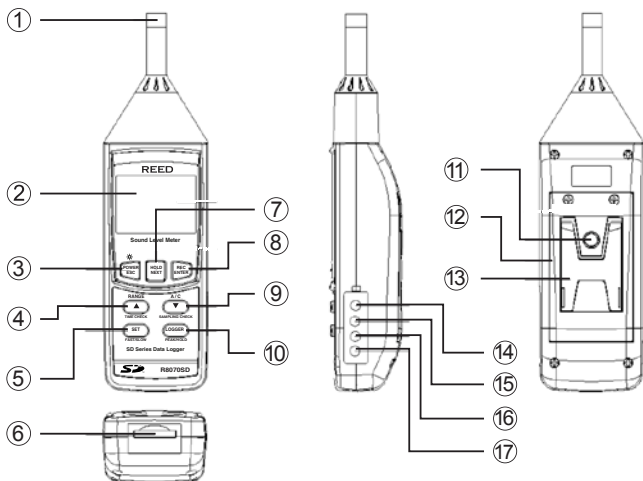

1. Microphone
2. LCD Display
3. POWER/ESC/Backlight Button
4. Up/Range/Time Check Button
5. SET/FAST/SLOW Button
6. SD Card Slot
7. HOLD/NEXT Button
8. REC/ENTER Button
9. Down/A/C/SAMPLING CHECK Button
10. Logger/Peak Hold Button
11. Tripod Mounting Screw
12. Battery Cover
13. Kickstand
14. AC Output Jack
15. Calibration Potentiometer
16. RS-232 Output Jack
17. Power Adapter Input

**REED Instruments**

1-877-849-2127 | [info@reedinstruments.com](mailto:info@reedinstruments.com) | [www.reedinstruments.com](http://www.reedinstruments.com)

## Display Description

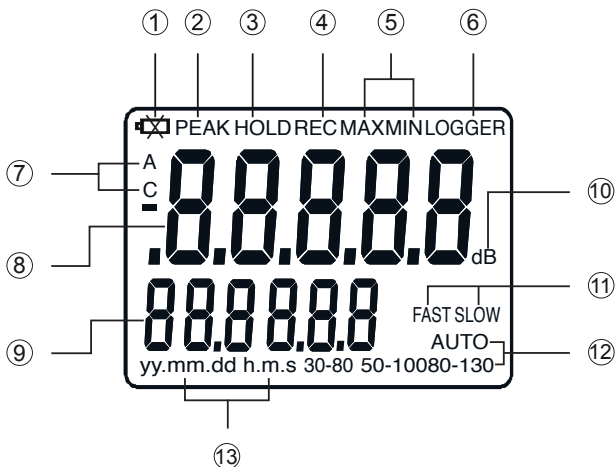

- |                                  |                                  |
|----------------------------------|----------------------------------|
| 1. Low Battery Indicator         | 7. Frequency Weighting Indicator |
| 2. Peak Indicator                | 8. Reading Indicator             |
| 3. Data Hold Indicator           | 9. Date/Time Values              |
| 4. Record Mode Indicator         | 10. Unit of Measure              |
| 5. Maximum and Minimum Indicator | 11. Time Weighting Indicator     |
| 6. Data logging Status Indicator | 12. dB Range indicators          |
|                                  | 13. Date/Time Stamp              |



# Operating Instructions

## Power ON/OFF

1. Turn the meter on by pressing the **POWER** button. To turn the meter off, press and hold the **POWER** button for 2 seconds.

**Note:** This meter can be powered by either six (6) 1.5VDC "AA" batteries or an optional AC adapter (sold separately).

## Basic Operation

1. At start up, the meter's default settings are "Auto Range", "A Frequency Weighting" and "Fast Time Weighting".

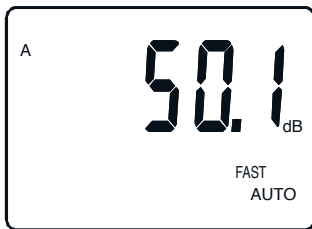

2. Press the **Fast/Slow** button to select the desired Response Time. If the sound source consists of short bursts, set the response to FAST (125ms). To measure average sound level, select SLOW (1 second).
3. Press the **A/C** button to select the Frequency weighting. Select "A" Weighting for a general noise sound level, or "C" Weighting for measuring high level noise. "C" Weighting is a standard weighting of the audible frequencies commonly used for the measurement of Peak Sound Pressure Level. If the "C" Weighted level is much higher than the "A" Weighted level, then there will be a large amount of low-frequency noise.
4. Press the **RANGE** button to scroll through the four dB range types. There are three manual dB ranges to select from and auto range. The manual ranges are described as follows:

**Range 1: 30 to 80dB range**

**Range 2: 50 to 100dB range**

**Range 3: 80 to 130dB range**

*continued...*

**REED Instruments**

1-877-849-2127 | info@reedinstruments.com | www.reedinstruments.com

5. Hold the instrument comfortably in one hand (away from your body) or position it on a tripod for long-term monitoring. Point the microphone in the direction of the noise to take a measurement.

**Note:** Direct contact with strong winds or blowing air on the microphone may cause measurement errors. These effects can be reduced by using the included windshield ball.

### *Data Hold*

1. While taking a measurement, press the **HOLD** button to freeze the current readings on the display.
2. While in this mode a HOLD symbol will appear.
3. Press the **HOLD** button again to resume normal operation.

**Note:** When the Data Hold feature is active all buttons except the **POWER** button are disabled.

### *Peak Hold*

1. While taking a measurement, press the **LOGGER** button to capture and freeze a noise peak.
2. While in this mode a PEAK symbol will appear and the displayed reading will only change when a higher sound peak is registered.
3. Press the **LOGGER** button again to resume normal operation.

### *Recording Maximum and Minimum Readings*

1. Press the **REC** button to enter recording mode as indicated by "REC" on the LCD. The meter will now begin recording maximum and minimum readings.
2. While in recording mode:
  - A) Press the **REC** button once and the maximum value will appear on the display as indicated by "REC MAX".
  - B) Press the **REC** button again and the minimum value will appear on the display as indicated by "REC MIN".
  - C) To exit recording mode and resume normal operation, press and hold the **REC** button for two seconds.

**Note:** When in recording mode the **POWER** button is disabled and the meter cannot be turned off.

*continued...*

## Backlight

After powering the meter ON, the LCD Backlight will turn on automatically. Press the BACKLIGHT button to turn the LCD Backlight on or off.

## Setup Mode

1. Press and hold the **SET** button for 2 seconds to enter Setup Mode.
2. Press the **NEXT** button continuously to scroll through the following parameters.

Parameter	Description
dAtE	Set the time and date
dEC	Set the decimal format (Basic (20.00) or European (20,00))
PoFF	Enable or disable the auto-power off function
bEEP	Turn the beeper on or off
SP-t	Set the data logging sampling rate
Sd F	Format the SD memory card

3. Once the appropriate parameter has been selected follow the associated instructions below.

**Note:** The meter automatically exits out of the Setup mode if no key is pressed within 7 seconds.

### Setting the Time and Date (dAtE)

1. Press the **ENTER** button when "dAtE" appears on the LCD.
2. Use the **▲** and **▼** buttons to adjust the year as indicated by "YY".
3. Press the **ENTER** button to confirm selection.
4. Repeat steps 2 and 3 for month, day, hour, minute and seconds as indicated by (mm/dd/h/m/s).
5. After each value has been selected and confirmed, the meter will automatically skip to the next parameter.

**Note:** At any time, you can press the **ESC** button to exit the Setup mode and resume normal operation. The internal clock will keep accurate time when the meter is powered off. When new batteries are installed the clock will have to be reset.

*continued...*

## ***Setting Data Decimal Format (dEC)***

Numeric formats vary in different countries. By default the meter is set to bASIC mode where a decimal point is used to separate units, (i.e. 20.00). The European format uses a comma (i.e. 20,00) to separate units. To change this setting, follow steps 1 and 2 when "dEC" appears on the LCD.

1. Use the ▲ and ▼ buttons to select between bASIC and Euro.
2. Press the **ENTER** button to confirm selection and skip to next parameter.

**Note:** At any time, you can press the **ESC** button to exit the Setup mode and resume normal operation.

## ***Enabling/Disabling Auto Power OFF (PoFF)***

Follow steps 1 and 2 when "PoFF" appears on the LCD.

1. Use the ▲ and ▼ buttons to select between ON (enabled) or OFF (disabled). With the Auto Power OFF feature enabled, the meter will automatically switch OFF after 10 minutes of inactivity to preserve battery life.
2. Press the **ENTER** button to confirm selection and skip to next parameter.

**Note:** At any time, you can press the **ESC** button to exit the Setup mode and resume normal operation.

## ***Enabling/Disabling the Beeper Sound (bEEP)***

Follow steps 1 and 2 when "bEEP" appears on the LCD.

1. Use the ▲ and ▼ buttons to select between ON (enabled) or OFF (disabled).
2. Press the **ENTER** button to confirm selection and skip to next parameter.

**Note:** At any time, you can press the **ESC** button to exit the Setup mode and resume normal operation.

## ***Setting the Data Logging Sampling Rate (SP-t)***

Follow steps 1 and 2 when "SP-t" appears on the LCD.

1. Use the ▲ and ▼ buttons to adjust the sampling rate between 0, 1, 2, 5, 10, 30, 60, 120, 300, 600, 1800, and 3600 seconds.
2. Press the **ENTER** button to confirm selection and skip to next parameter.

**Note:** At any time, you can press the **ESC** button to exit the Setup mode and resume normal operation.

*continued...*

## ***Formatting the SD Card (Sd F)***

Follow steps when "Sd F" appears on the LCD.

1. Use the ▲ and ▼ buttons to select YES to format the card. Select NO to abort.
2. Press the **ENTER** button to confirm selection.
3. Press the **ENTER** button again to re-confirm.
4. The meter will format the SD card and automatically return to the Setup menu when formatting is complete.
5. Press the **ESC** button to exit the Setup mode and resume normal operation.

**Note:** It is recommended that new SD cards should be formatted prior to first use. If the formatting process fails, the meter will display Sd -E-.

## ***Checking Time and Date***

During normal operation, hold the **TIME CHECK** button to display the year, month, day, hour, minutes and seconds.

## ***Checking Sampling Rate***

During normal operation, hold the **SAMPLING CHECK** button to view the selected sampling rate.

# **Data Logging**

## ***Data Recording Modes***

**Manual Data Logging:** Manually log up to 99 readings on a SD memory card (see *Manual Data Logging Mode* section for details).

**Automatic Data Logging:** Setup the meter parameters in order to automatically log data on a SD memory card. The number of data points is limited by the size of the memory card.

**Note:** It is recommended to use a class 4 SDHC memory card between 1Gb and 16Gb. Insert the SD memory card in the slot at the bottom of the meter. The card must be inserted with the label side facing the rear of the meter.

*continued...*

## *Manual Data Logging Mode*

In manual mode the **LOGGER** button is pressed to manually log a reading on the inserted SD card at any time. In order to setup the meter for manual data logging, follow steps 1 through 8 below.

1. Set the data logging sampling rate to '0' seconds.
2. Press the **REC** button to enter manual data logging mode.
3. "REC" will appear on the LCD as well as P-X (X = memory position number between 1 and 99).
4. Press the **SET** button to set the desired memory position.
5. Use the **▲** and **▼** buttons to select one of the 99 data memory positions in which to record.
6. Press the **ENTER** button to confirm the selection. Repeat steps 4 to 6 for every selection.
7. Press the **LOGGER** button to save a reading to memory. "LOGGER" will flash each time a data point is stored.
8. To exit manual data logging mode, press and hold the **REC** button 2 seconds to resume normal operation.

**Note:** The meter will scan for a SD memory card when a first manual recording is attempted. If a card is not inserted or the card is defective, the meter will flash CARd-E-. In this case, power the meter OFF and try again with another SD memory card.

## *Automatic Data Logging Mode*

In automatic mode the desired data logging sampling rate is set to 1, 2, 5, 10, 30, 60, 120, 300, 600, 1800 or 3600 seconds prior to recording. In order to setup the meter for automatic data logging, follow steps 1 through 5 below.

1. Press the **REC** button and "REC" will appear on the LCD.
2. Press the **LOGGER** button to enter automatic data logging mode.
3. The "REC" icon will continuously flash while the "LOGGER" will flash every time a reading is stored at the user selected sampling rate.
4. To pause the data logging session press the **LOGGER** button and both the **REC** & **LOGGER** buttons will stop flashing. To resume press the **LOGGER** button again.

*continued...*

- To end the current data logging session pause the data logging session and hold the **REC** button for 2 seconds.

**Note:** The meter will scan for a SD memory card when a first manual recording is attempted. If a card is not inserted or the card is defective, the meter will flash "CaRD-E-". In this case, power the meter OFF and try again with another SD memory card.

### *Transferring Data from the SD Memory Card to a Computer*

- While the meter is powered OFF remove the SD memory card from the SD card slot.
- Insert the SD memory card into the computer.
- Open the file(s) with Excel.

See below for an Excel sample file.

Place	Date	Time	Value	Unit
1	19-07-10	0:05:02	42.5	dB
2	19-07-10	0:05:04	45.3	dB
3	19-07-10	0:05:06	52	dB
4	19-07-10	0:05:08	58.5	dB
5	19-07-10	0:05:10	58.1	dB
6	19-07-10	0:05:12	64	dB
7	19-07-10	0:05:14	50.8	dB
8	19-07-10	0:05:16	41.1	dB
9	19-07-10	0:05:18	41.5	dB
10	19-07-10	0:05:20	41.1	dB
11	19-07-10	0:05:22	44.7	dB

The raw data can be used to create a graph in Excel. See sample below:

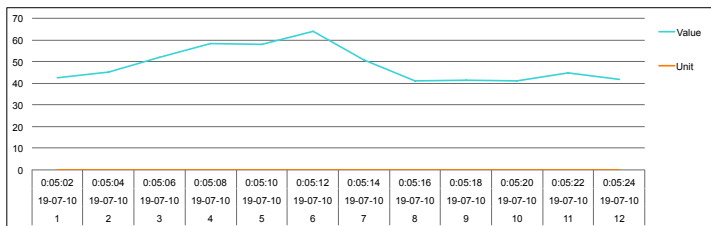

*continued...*

## Calibration Procedure

In order to calibrate the R8070SD, an external calibrator that can provide a 94.0dB signal is required (REED R8090). If the meter has been exposed to extreme conditions or has not been used in a long period of time the meter should be calibrated by following steps 1 through 7 below.

1. Remove the windshield ball.
2. Power on the meter.
3. Select "50 - 100dB" range.
4. Select "FAST" time weighting.
5. Select "A" weighting.
6. Insert Microphone into the sound calibrator's microphone adapter.
7. Power on the sound calibrator (R8090).

If the measured value is not within "94  $\pm$ 0.2" dB, adjust the meter's calibration potentiometer until the display matches the output of the calibrator (94.0dB).

## Data Stream Output

Using Terminal application, a data stream can be viewed from the RS-232 output, Connect the RS-232/USB cable between the product and terminal/PC and use the following setting to view the data stream.

Terminal Settings:

- Bits per second: 9600
- Data bits: 8
- Parity: None
- Stop bits: 1

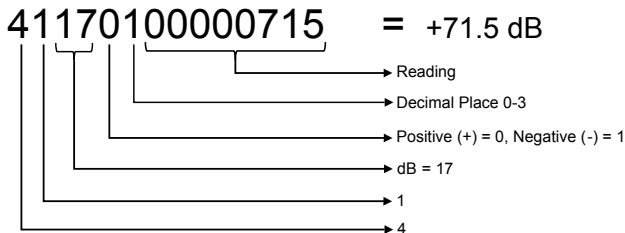

*continued...*

**REED Instruments**

1-877-849-2127 | info@reedinstruments.com | www.reedinstruments.com



## 3.5mm Terminal to RS-232 Serial Connection

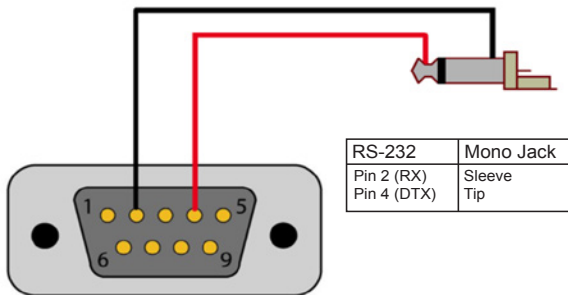

## Battery Replacement

When the low battery icon  appears on the LCD, the batteries must be replaced.

1. Remove the two (2) Phillips screws on the back of the meter directly located above the top of the kickstand.
2. Remove the battery cover.
3. Replace 6 x 1.5V "AA" batteries.
4. Secure the battery cover with the two (2) Phillips screws.

## Applications

- Preventative Maintenance
- Industrial Machinery/Equipment
- Construction Sites
- Ensuring Safe Working Conditions
- Public Venues/Concerts
- Code Enforcement
- Traffic
- Appliance Noise Testing
- Long-term Measurement
- Recording of Acoustic Levels for Environmental Impact Studies

## Accessories and Replacement Parts

**R8090** Sound Calibrator

**REED-WB** Windshield Ball

**RSD-ADP-NA** Power Supply, 110V

**RSD-ADP-EU** Power Supply, 220V

**SD-4GB** 4GB SD Memory Card

**RSD-16GB** 16GB Micro SD Memory Card w/ Adapter

**R1500** Tripod

**CA-05A** Soft Carrying Case

**R8888** Deluxe Hard Carrying Case

Don't see your part listed here? For a complete list of all accessories and replacement parts visit your product page on [www.reedinstruments.com](http://www.reedinstruments.com).

## Frequently Asked Questions (FAQ's)

### **I cannot turn off my meter, do you know why?**

Often times the meter cannot be turned off because it is in recording mode ("REC" mode). Make sure to exit that function by holding down the REC button before attempting to turn your meter off.

### **How long can I record for?**

Battery life will depend on a number of factors:

- Quality of Battery
- Whether the beeper is ON or OFF
- Whether the backlight is ON or OFF
- Environmental Conditions during data logging

As a reference, using alkaline batteries with both the backlight and beeper on while automatic data logging at a 2 second sampling rate; the batteries lasted approximately 14 hours.

### **Does this sound level meter have the capabilities to do a 8 hour TWA?**

The R8070SD does not automatically calculate an 8-hour TWA. The user would have to export the data to Excel and calculate the TWA with an Excel function.

## Product Care

To keep your instrument in good working order we recommend the following:

- Store your product in a clean, dry place.
- Change the battery as needed.
- If your instrument isn't being used for a period of one month or longer please remove the battery.
- Clean your product and accessories with biodegradable cleaner. Do not spray the cleaner directly on the instrument. Use on external parts only.

## Product Warranty

REED Instruments guarantees this instrument to be free of defects in material or workmanship for a period of one (1) year from date of shipment. During the warranty period, REED Instruments will repair or replace, at no charge, products or parts of a product that proves to be defective because of improper material or workmanship, under normal use and maintenance. REED Instruments total liability is limited to repair or replacement of the product. REED Instruments shall not be liable for damages to goods, property, or persons due to improper use or through attempts to utilize the instrument under conditions which exceed the designed capabilities. In order to begin the warranty service process, please contact us by email at 1-877-849-2127 or [info@reedinstruments.com](mailto:info@reedinstruments.com) to discuss the claim and determine the appropriate steps to process the warranty.

## Product Disposal and Recycling



Please follow local laws and regulations when disposing or recycling your instrument. Your product contains electronic components and must be disposed of separately from standard waste products.

## Product Support

If you have any questions on your product, please contact your authorized REED distributor or REED Instruments Customer Service by phone at 1-877-849-2127 or by email at [info@reedinstruments.com](mailto:info@reedinstruments.com).

Please visit [www.REEDINSTRUMENTS.com](http://www.REEDINSTRUMENTS.com) for the most up-to-date manuals, datasheets, product guides and software.

*Product specifications subject to change without notice.  
All rights reserved. Any unauthorized copying or reproduction of this manual is strictly prohibited without prior written permission from REED Instruments.*

# REED

## INSTRUMENTS

### TEST & MEASURE WITH CONFIDENCE



**CHECK OUT OUR LATEST PRODUCTS!**

**REED Instruments**

1-877-849-2127 | [info@reedinstruments.com](mailto:info@reedinstruments.com) | [www.reedinstruments.com](http://www.reedinstruments.com)

# REED INSTRUMENTS

TEMPERATURE  
& HUMIDITY



SOUND



MOISTURE



AIR VELOCITY



ELECTRICAL



**REED Instruments**

1-877-849-2127 | [info@reedinstruments.com](mailto:info@reedinstruments.com) | [www.reedinstruments.com](http://www.reedinstruments.com)