

# Dimensional Drawing

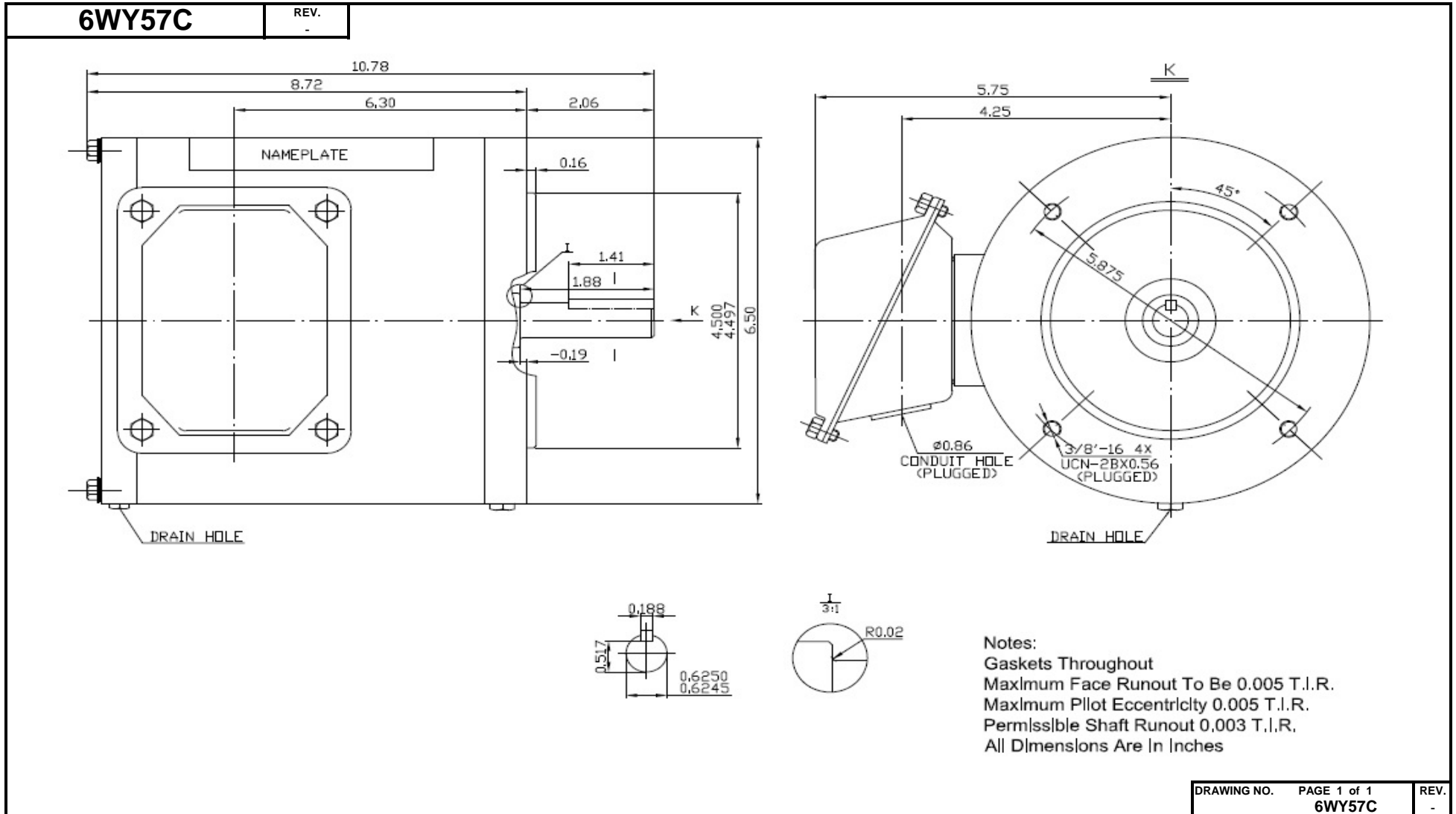

# Performance Data



**6WY57C**

REV.  
-

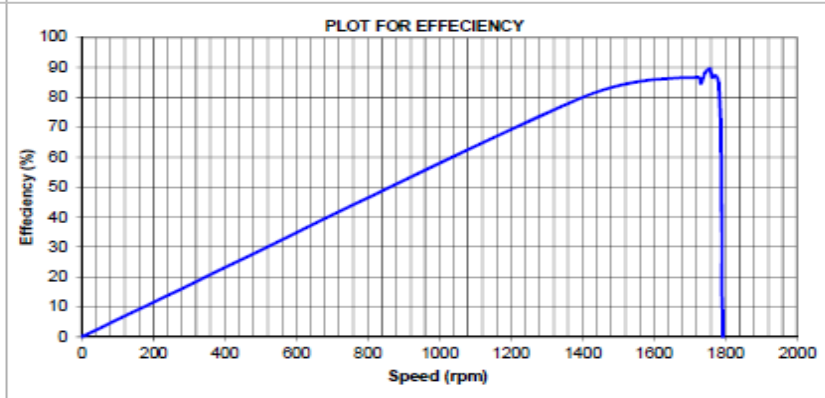
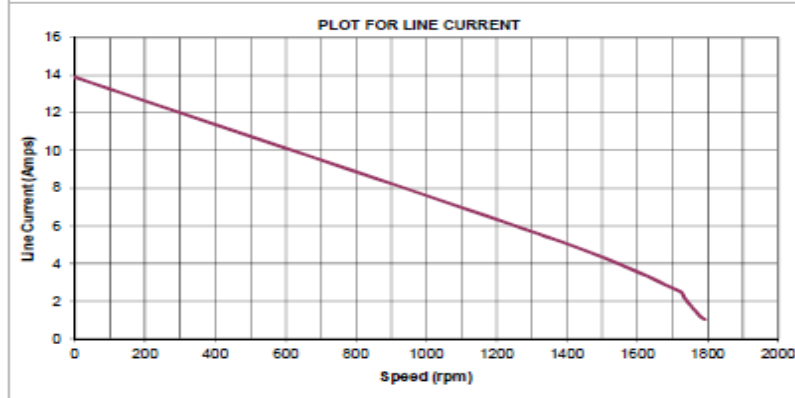
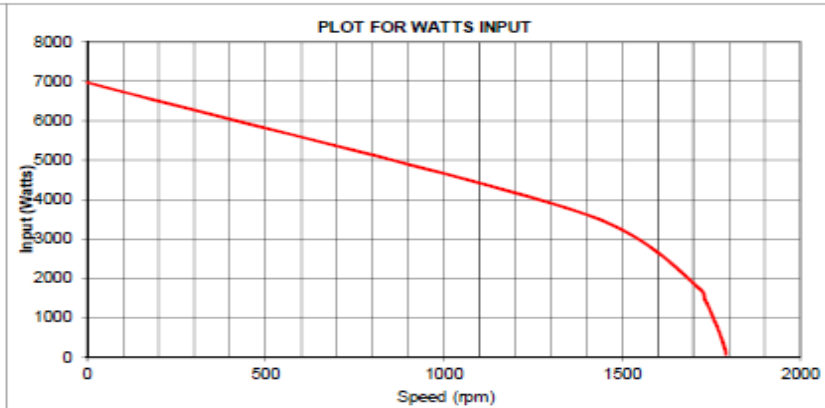
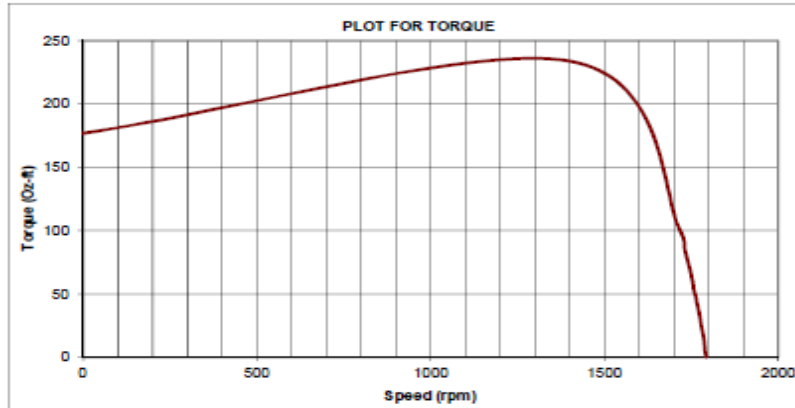

Model No: 6WY57C      Curve at 460 Volts , 60Hz, 1HP,1740 RPM

Full load torque	47.5 Oz-ft
BD Torque	234.0 Oz-ft
LR Torque	177 Oz-ft

Full load Amps	1.52 Amps
PU Torque	150 Oz-ft
LR AMPS @ 460V	13.9 Amps

DRAWING NO.	PAGE 1 of 2	REV.
	<b>6WY57C</b>	-

Dayton Electric Mfg. Co. Lake Forest, IL 60045 USA

# Performance Data



6WY57C		REV. -								
	Speed	Torque	Watts In	Current	Power Factor	Capacitor Volt	Efficiency	Watts Loss	Motor Mode	
No load	1792	0	68	1.03	8		0	68	0.00FL	
	1787	11.92	270	1.08	29		68.89	84	0.25FL	
	1780	23.72	436	1.16	48		85.55	63	0.50FL	
	1772	35.40	640	1.31	61		87.34	81	0.75FL	
Full load	1763	47.44	860	1.52	71		86.74	114	1.00FL	
	1757	53.81	956	1.61	74		89.75	98	1.15FL	
	1754	59.47	1041	1.71	77		89.53	109.00	1.25FL	
	1743	72.33	1268	1.96	81		88.25	149	1.50FL	
	1731	86.14	1490	2.23	84		84.58	185	1.75FL	
	1720	98.88	1719	2.52	86		86.79	227	2.00FL	
Break Down	1400	234	3620	5.04	90		80	724	BD	
Locked Roto	0	177	6969	13.9	63		0	6969	LR	

DRAWING NO.	PAGE 2 of 2	REV.
6WY57C		-

**6WY57C**

REV.  
0

## SCHEMATIC

LOW VOLT 2Y

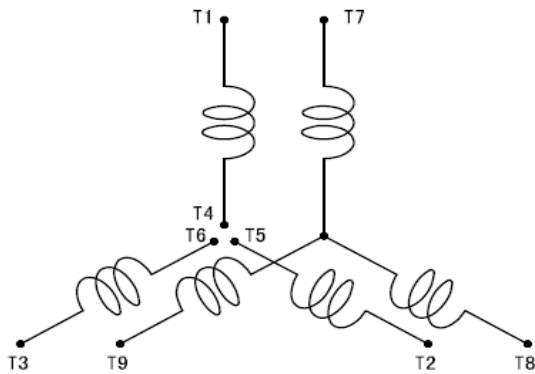

HIGH VOLT Y

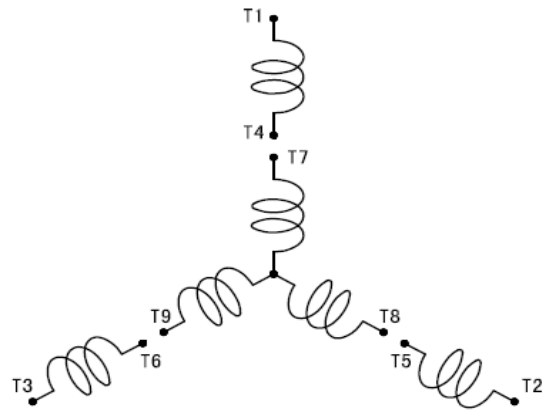

## CONNECTION

LOW VOLT 2Y

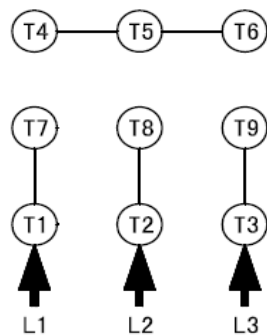

HIGH VOLT Y

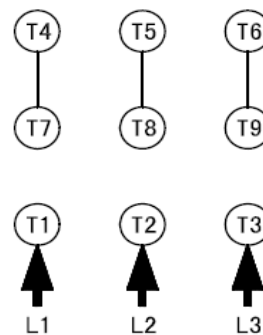

DRAWING NO.	PAGE 1 of 1	REV.
6WY57C		0