



OM-245 368D

2014-07

CoolBelt™ Helmet Cooling System



To help us serve you better, go to www.MillerWelds.com/CoolerNow

TABLE OF CONTENTS

SECTION 1 – HELMET COOLER SAFETY PRECAUTIONS – READ BEFORE USING	1
1-1. Symbol Usage	1
1-2. Hazards	1
1-3. Proposition 65 Warnings	2
1-4. Principal Safety Standards	2
SECTION 2 – BATTERY SAFETY PRECAUTIONS – READ BEFORE USING	3
2-1. Symbol Usage	3
2-2. Hazards	3
2-3. Proposition 65 Warnings	4
2-4. Principal Safety Standards	4
SECTION 3 – HELMET COOLING SYSTEM	5
3-1. Helmet Cooling System Specifications	5
3-2. Installing Headgear And Shroud	6
3-3. Charging The Battery	7
3-4. Installing The Battery	8
3-5. Installing The Filter	9
3-6. Attaching The Connecting Hose	10
3-7. Operating The Controls	11
3-8. Checking The Helmet Cooling System Before Use	12
3-9. Putting On The Helmet Cooling System	13
3-10. Changing Hose Length	14
3-11. Replacing Belt	15
3-12. Maintenance And Storage	16
3-13. Helmet Cooling System Troubleshooting	16
SECTION 4 – ADJUSTING HEADGEAR	18
SECTION 5 – PARTS LIST	19
SECTION 6 – LIMITED WARRANTY	20

SECTION 1 – HELMET COOLER SAFETY PRECAUTIONS – READ BEFORE USING

-  **Protect yourself and others from injury — read, follow, and save these important safety precautions and operating instructions.**

1-1. Symbol Usage

Helmet Cooler 2013-09



DANGER! – Indicates a hazardous situation which, if not avoided, will result in death or serious injury. The possible hazards are shown in the adjoining symbols or explained in the text.

 Indicates special instructions.



This group of symbols means Warning! Watch Out! ELECTRIC SHOCK, MOVING PARTS, and HOT PARTS hazards. Consult symbols and related instructions below for necessary actions to avoid the hazards.



Indicates a hazardous situation which, if not avoided, could result in death or serious injury. The possible hazards are shown in the adjoining symbols or explained in the text.

NOTICE – Indicates statements not related to personal injury.

1-2. Hazards

-  **Only qualified persons should install, operate, maintain, and repair this unit.**

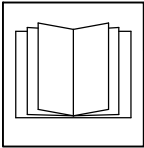

READ INSTRUCTIONS.

- Read and follow all labels and the Owner's Manual carefully before installing, operating, or servicing unit. Read the safety information at the beginning of the manual and in each section.

- Use only genuine replacement parts from the manufacturer.
- Perform maintenance and service according to the Owner's Manuals, industry standards, and national, state, and local codes.



HELMET COOLER MISUSE can be hazardous.

Welding produces fumes and gases. Breathing these fumes and gases can be hazardous to your health.

- Read and follow these instructions and the safety labels carefully. This product is intended for use as a cooling device only. It is not a respiratory protective device and does not protect the user from airborne contaminants. Have an industrial hygienist test the air in your facility to determine if respiratory protection is required to provide adequate protection from contaminants in your environment. With cooling system-equipped helmet on your head and cooling system operating, also test the air inside the helmet to determine if respiratory protection is required. If you have questions about the type of respiratory protection equipment required, consult your safety director and a certified Industrial Hygienist.
- Do not use this product where there is danger of fire or explosion.
- Do not use this product in windy conditions or negative pressure inside the hood may draw in contaminants from the outside air.
- Do not use this product without a properly installed spark guard unless the unit is designed and intended to be used without one. Without the spark guard (on applicable products), welding sparks may ignite the filter or damage the filter.
- This product does not supply oxygen. Do not use this product where oxygen levels are 19.5% or lower, where contaminant levels are unknown or are immediately dangerous to life or health (IDLH), or where the contaminant levels exceed the equipment specifications.

- Do not enter a work area until you are sure the equipment is correctly assembled, working properly, and properly worn.
- Before each use, inspect the equipment for damage and verify it operates properly.
- Dangerous contaminants may not smell or be visible. Leave the area immediately if you notice the following:
 - ... Breathing becomes difficult.
 - ... You experience dizziness, impaired vision, or eye, nose, or mouth irritation.
 - ... The equipment is damaged.
- Do not repair, modify, or disassemble this product or use with parts or accessories not supplied by the manufacturer.
- Do not operate unit without properly installed filter(s). Replace damaged or plugged filters. Do not wash or reuse filters. Do not clean filters by tapping or with compressed air or filter elements may be damaged.
- Do not restrict or alter helmet cooler air flow. Do not block air inlet or outlet. Be sure safety glasses, hair, weld cap, and other objects do not block air flow.
- This product contains electrical parts which have not been evaluated as an ignition source in flammable or explosive atmospheres by MSHA/NIOSH.

1-3. Proposition 65 Warnings



Welding or cutting equipment produces fumes or gases which contain chemicals known to the State of California to cause birth defects and, in some cases, cancer. (California Health & Safety Code Section 25249.5 et seq.)



This product contains chemicals, including lead, known to the state of California to cause cancer, birth defects, or other reproductive harm. *Wash hands after use.*

1-4. Principal Safety Standards

Safety in Welding, Cutting, and Allied Processes, ANSI Standard Z49.1, is available as a free download from the American Welding Society at <http://www.aws.org> or purchased from Global Engineering Documents (phone: 1-877-413-5184, website: www.global.ihs.com).

Safe Practice For Occupational And Educational Eye And Face Protection, ANSI Standard Z87.1, from American National Standards Institute, 25 West 43rd Street, New York, NY 10036 (phone: 212-642-4900, website: www.ansi.org).

SECTION 2 – BATTERY SAFETY PRECAUTIONS – READ BEFORE USING

-  **Protect yourself and others from injury — read, follow, and save these important safety precautions and operating instructions.**

2-1. Symbol Usage

Small Batt 2013-10



DANGER! – Indicates a hazardous situation which, if not avoided, will result in death or serious injury. The possible hazards are shown in the adjoining symbols or explained in the text.

 Indicates special instructions.



This group of symbols means Warning! Watch Out! **ELECTRIC SHOCK, MOVING PARTS, and HOT PARTS** hazards. Consult symbols and related instructions below for necessary actions to avoid the hazards.



Indicates a hazardous situation which, if not avoided, could result in death or serious injury. The possible hazards are shown in the adjoining symbols or explained in the text.

NOTICE – Indicates statements not related to personal injury.

2-2. Hazards



Only qualified persons should install, operate, maintain, and repair this unit.

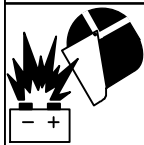
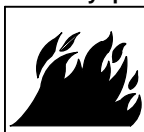

FIRE OR BATTERY EXPLOSION hazard.

- During operation keep everyone, especially children, away.
- Do not install or place charger on, over, or near combustible surfaces.
- Do not charge battery near flammables.
- Examine the battery before first use. Return battery to the manufacturer if battery is damaged, dirty, or emits an unusual odor.
- Use battery only with equipment with which it was supplied. Replace battery only with battery specified in Owner's Manual. Use of another battery may present a risk of fire or explosion.
- Keep battery dry.
- Do not use or store the battery in extremely hot or humid conditions. See the Owner's Manual for specific operating and storage information.
- Keep battery away from fire, out of direct sunlight, and away from other sources of heat.
- Do not use or charge the battery if it has been dropped or damaged.
- Do not open, puncture, repair, disassemble, or modify the battery.
- Charge battery only with supplied charger in an open, well-ventilated location out of direct sunlight and according to supplied instructions.
- Do not overcharge a battery or charge battery longer than specified (if charger is not equipped with automatic shutoff). See the Owner's Manual for specific information on battery charging.
- Do not charge battery by connecting directly to AC receptacle. Do not connect battery charger to automobile auxiliary power receptacle.
- Do not connect (short circuit) battery terminals to each other. Do not allow tools, conductive materials, or other objects to touch both battery terminals at the same time.
- Do not weld on battery or fasten any objects to battery.
- Do not heat battery in a microwave oven or any other heating device.
- Keep battery away from sources of high voltage.
- Do not expose battery to static electricity.
- Do not use or mix battery with damaged or worn out batteries, or other types of batteries.



BATTERY ACID can BURN SKIN and EYES.

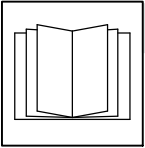

- Replace damaged battery.
- Do not touch materials from inside a damaged battery.
- Flush eyes and skin immediately with water.



READ INSTRUCTIONS.

- Read and follow all labels and the Owner's Manual carefully before using the battery or battery charger. Read the safety information at the beginning of the manual and in each section.
- Dispose of battery according to local, state, and federal requirements. Do not dispose of battery in fire or water.
- Contact the equipment manufacturer if you have any questions about the battery.

2-3. Proposition 65 Warnings

-  **Welding or cutting equipment produces fumes or gases which contain chemicals known to the State of California to cause birth defects and, in some cases, cancer. (California Health & Safety Code Section 25249.5 et seq.)**
-  **This product contains chemicals, including lead, known to the state of California to cause cancer, birth defects, or other reproductive harm. *Wash hands after use.***

2-4. Principal Safety Standards

Safety in Welding, Cutting, and Allied Processes, ANSI Standard Z49.1, is available as a free download from the American Welding Society at <http://www.aws.org> or purchased from Global Engineering Documents (phone: 1-877-413-5184, website: www.global.ihs.com).

Safe Practice For Occupational And Educational Eye And Face Protection, ANSI Standard Z87.1, from American National Standards Institute, 25 West 43rd Street, New York, NY 10036 (phone: 212-642-4900, website: www.ansi.org).

SECTION 3 – HELMET COOLING SYSTEM



Read and follow these instructions and the safety labels carefully. This product is intended for use as a cooling device only. It is not a respiratory protective device and does not protect the user from airborne contaminants. Have an industrial hygienist test the air in your facility to determine if respiratory protection is required to provide adequate protection from contaminants in your environment. With cooling system-equipped helmet on your head and cooling system operating, also test the air inside the helmet to determine if respiratory protection is required. If you have questions about the type of respiratory protection equipment required, consult your safety director and an Industrial Hygienist.

 Use the cooling system only with compatible Miller welding helmets (see Specifications below). See the welding helmet Owner's Manual for information on helmet operation.

The helmet cooling system draws in air and blows it into the welding helmet shroud through a flexible connecting hose. The system must include and/or be used with the equipment listed below:

- Helmet and head shroud
- Connecting hose
- Blower assembly with filtration system (spark guard and filter)
- Belt assembly
- Battery charger

The helmet cooling system operates at temperatures from 23° to 131°F and provides air flow of 6 CFM (low speed) to 7 CFM (high speed) under normal conditions. Battery life is reduced when the unit is used in a dirty environment. (The blower assembly Batt light goes on when battery power is low.)

3-1. Helmet Cooling System Specifications

Application	Fits Most Miller Welding Helmets: Elite, Digital Elite, MP-10, Performance [®] , Pro-Hobby [®] , Titanium, XLix
Size (Blower Assembly)	6-5/8 x 6-1/2 x 2-3/8 in (169.4 x 164.1 x 57.4 mm)
Weight (Blower Assembly w/Battery, Filter, Belt, Hose)	25.6 oz. (726 g)
Filter  Filter is required for proper operation of equipment, but does not provide respiratory protection.	Use Miller Filter Only (Miller Part No. 245 233)
Air Flow	Low Speed: 6+ CFM (170+ LPM) minimum High Speed: 7 CFM (200 LPM)
Operating Temperature	23° to 131°F (-5° to 55°C)
Storage Temperature	-4° to 140°F (-20° to 60°C)
Battery Type	Rechargeable Lithium
Battery Charging Time	Four Hours (typical)
Battery Life	500 Charges Run Time At High Speed: 4-1/2 Hours Run Time At Low Speed: 6 Hours (Run Time Dependent On Air Flow Rate And Filter Load.)
Belt Size	Up To 48 in. (122 cm)
Shroud Service Life	Replace After 50 Washings

3-2. Installing Headgear And Shroud

Use bottom hole for quick release Elite and Titanium helmets. Use top hole for all other helmets.

⚠ After installing shroud, make sure there are no gaps between shroud and helmet edge.

- 1 Standard Headgear
- 2 Velcro Strip
- 3 Cooling System Headgear
- 4 Shroud
- 5 Velcro On Shroud

Remove knobs, o-rings, and washers from standard headgear. Remove headgear.

Use damp towel to clean area inside helmet where Velcro® will be installed. Allow cleaned area to dry.

Remove backing from Velcro. Install Velcro strip 5/8 in. (1.5 cm) from edge of quick release Elite and Titanium helmets. For all other helmets, install Velcro 3/4 in. (2 cm) from edge of helmet.

Position cooling system headgear in helmet. Install headgear mounting screw in headgear bottom hole (quick release Elite and Titanium helmets) or top hole (all other helmets).

Secure headgear with knobs, o-rings, and washers.

Align Velcro on shroud with Velcro strip inside helmet. Press the Velcro surfaces securely together.

Check for gaps between shroud and helmet. Reposition shroud and Velcro if necessary.

☞ Remove shroud from helmet when using helmet with the cooling system turned off.

☞ See Section 4 for headgear adjustment information.

Ref. 231 425 / Ref. 804 111

3-3. Charging The Battery

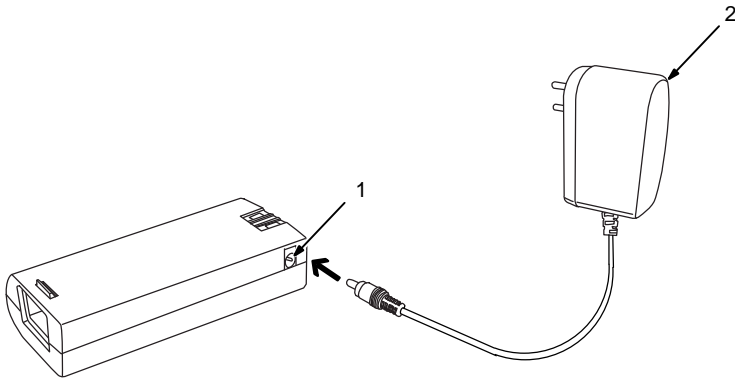
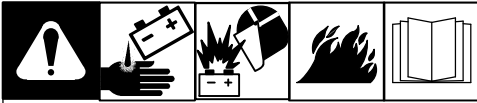

⚠ Charge battery only with supplied charger in an open, well-ventilated location.

⚠ Do not allow battery to get wet. Do not attempt to open the battery case.

⚠ Keep battery away from fire or heat.

☞ *Charge battery before first use or if battery has not been used for five days. If battery was not*

used for three months or longer, fully discharge and recharge battery twice (for optimal battery life).

☞ *Dispose of battery at a designated collection facility.*

☞ *Battery charging stops when battery is fully charged.*

1 Battery Terminal

2 Battery Charger

3 120 Volt AC Receptacle (Not Shown)

Remove battery from blower assembly (Section 3-4).

Connect charger cord to battery terminal. Connect charger to 120 volt AC receptacle.

The charger red light goes on when battery is being charged. When fully charged, the charger green light goes on. Charging normally takes about four hours.

3-4. Installing The Battery

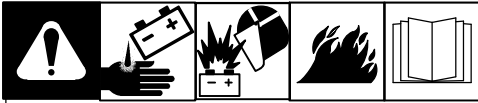

⚠ Do not allow battery to get wet. Do not attempt to open the battery case.

⚠ Keep battery away from fire or heat.

1 Battery

2 Blower Assembly

Slide battery into blower assembly until it locks into position.

3 Battery Release

To remove battery, lift battery release while pulling battery away from blower assembly.

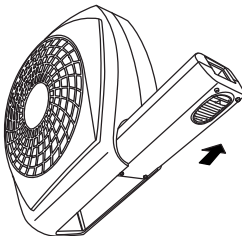
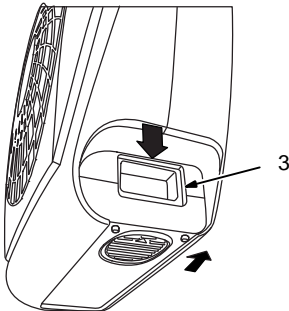
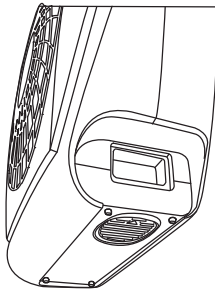
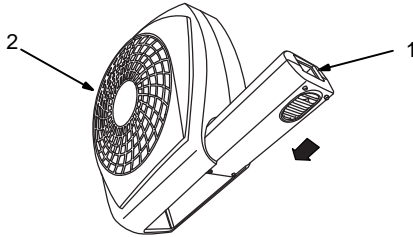

3-5. Installing The Filter

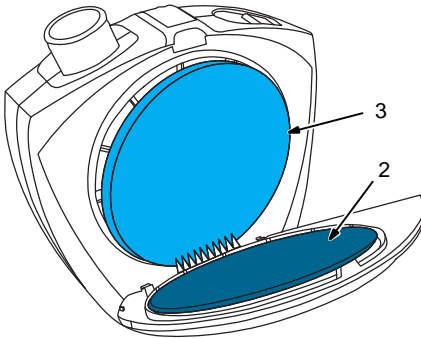
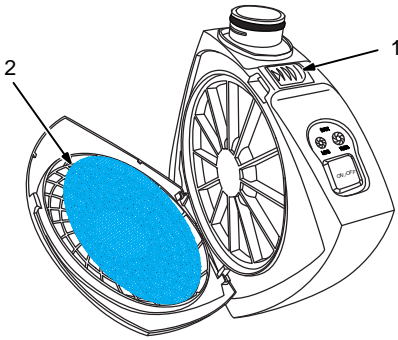

⚠ Do not use the helmet cooling system without the spark guard screen and filter installed.

⚠ Replace damaged or dirty filter. Do not wash filter, clean with compressed air, reverse filter, or reuse dirty filter.

☞ Filter is required for proper operation of equipment, but does not provide respiratory protection.

- 1 Cover Release
- 2 Spark Guard Screen
- 3 Filter

Push on release to open cover.

Install screen in cover.

Install filter in recessed area on blower housing.

☞ Install filter in recessed area on blower housing, not in the cover.

Close cover.

3-6. Attaching The Connecting Hose



⚠ Be sure connecting hose is properly installed or cooler will not work properly.

1 Release Buttons

Align hose connector (round end) with outlet on blower assembly. Press release buttons and slide hose connector over outlet until it locks in position

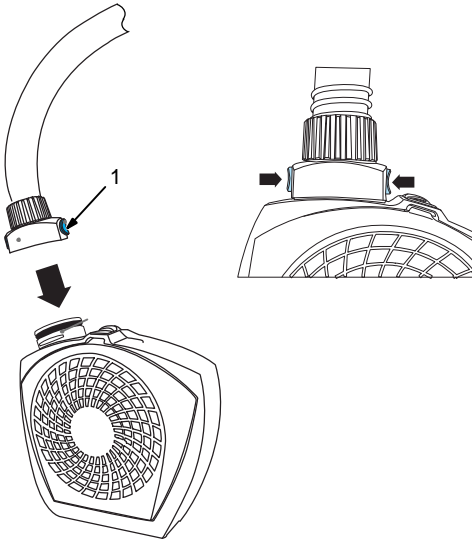

2 Locking Tab

Push hose connector (rectangular end) into helmet air inlet until hose locks in position. (Locking tab should be on outside of helmet air inlet.

⚠ Do not insert hose locking tab into helmet inlet. Locking tab should be on outside of helmet air inlet.

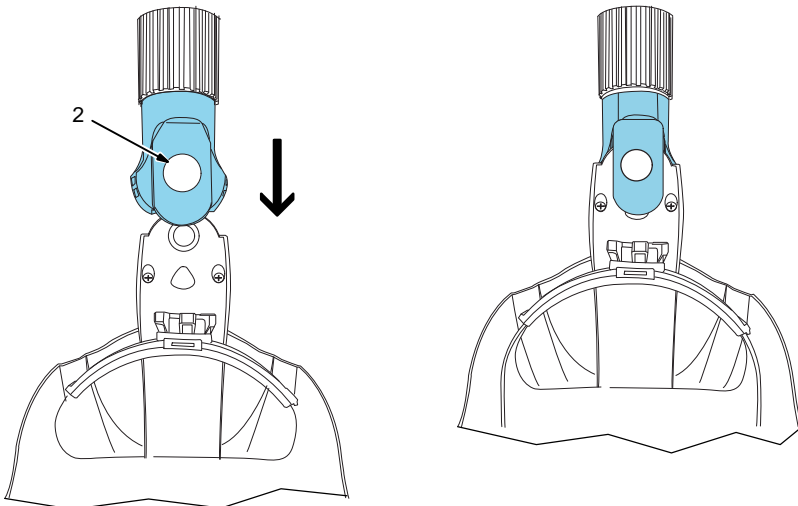

3-7. Operating The Controls

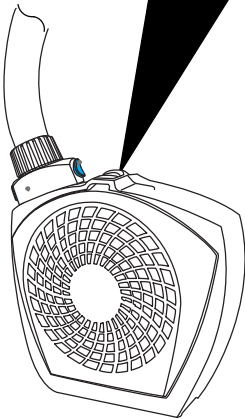
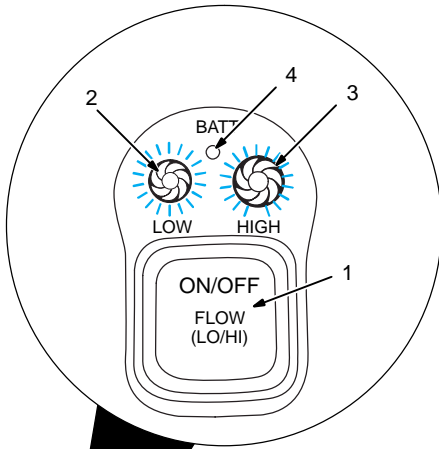

! Read and follow these instructions and the safety labels carefully. This product is intended for use as a cooling device only. It is not a respiratory protective device and does not protect the user from airborne contaminants. Have an industrial hygienist test the air in your facility to determine if respiratory protection is required to provide adequate protection from contaminants in your environment. With cooling system-equipped helmet on your head and cooling system operating, also test the air inside the helmet to determine if respiratory protection is required. If you have questions about the type of respiratory protection equipment required, consult your safety director and an Industrial Hygienist.

! Do not restrict or alter helmet cooling system air flow. Be sure safety glasses, hair, weld cap, and other objects do not block air flow.

- 1 On/Off Button
- 2 Low Speed Indicator
- 3 High Speed Indicator
- 4 Battery Level Indicator

To Start: Press On button for 1–2 seconds until alarm sounds and blower starts.

The blower always starts at the low speed. Press the On/Off button to switch between Low and High speeds.

To Stop: Press Off button for 2 – 3 seconds until the audible alarm and the blower stop.

The Battery Level indicator lights when battery power is low. See Section 3-3 for battery charging information.

 *The Battery Level indicator lights for several seconds after blower is started.*

3-8. Checking The Helmet Cooling System Before Use



⚠ Read and follow these instructions and the safety labels carefully. This product is intended for use as a cooling device only. It is not a respiratory protective device and does not protect the user from airborne contaminants. Have an industrial hygienist test the air in your facility to determine if respiratory protection is required to provide adequate protection from contaminants in your environment. With cooling system-equipped helmet on your head and cooling system operating, also test the air inside the helmet to determine if respiratory protection is required. If you have questions about the type of respiratory protection equipment required, consult your safety director and an Industrial Hygienist.

⚠ Do not restrict or alter helmet cooling system air flow. Be sure safety glasses, hair, weld cap, and other objects do not block air flow.

Before using the helmet cooling system, check the following items:

- 1 Filter And Spark Guard (Section 3-5)

☞ Filter is required for proper operation of equipment, but does not provide respiratory protection.

Verify the filter and spark guard are undamaged, properly assembled, and securely connected to the blower assembly.

- 2 Flexible Hose (Section 3-6)

Be sure the hose is undamaged and properly connected to the blower assembly and shroud.

- 3 Battery (Sections 3-3 And 3-4)

Verify the battery is fully charged and securely installed in the blower assembly.

- 4 Air Flow (Section 3-7)

Turn on blower assembly and test air flow at low and high speeds.

- 5 Shroud (Section 3-2)

Inspect the shroud and replace if damaged. See Troubleshooting (Section 3-13) if air is not being supplied to front of helmet.

Put on helmet and adjust helmet so helmet fits snugly on head. Verify shroud is properly installed on helmet.

☞ See the welding helmet Owner's Manual for helmet adjustment information.

- 6 Fabric Shroud (Section 3-2)

Inspect the shroud and replace if damaged. See Troubleshooting (Section 3-13) if air is not being supplied to shroud.

☞ See Section 4 for headgear adjustment information.

3-9. Putting On The Helmet Cooling System



⚠ Do not use the equipment belt or straps as a safety harness.

Place blower assembly against lower back with hose extending upwards. Fasten belt around waist. Adjust belt so unit rests comfortably against lower back.

Put on helmet and adjust helmet so helmet fits snugly on head. Tighten shroud drawstring to establish a tight seal around head.

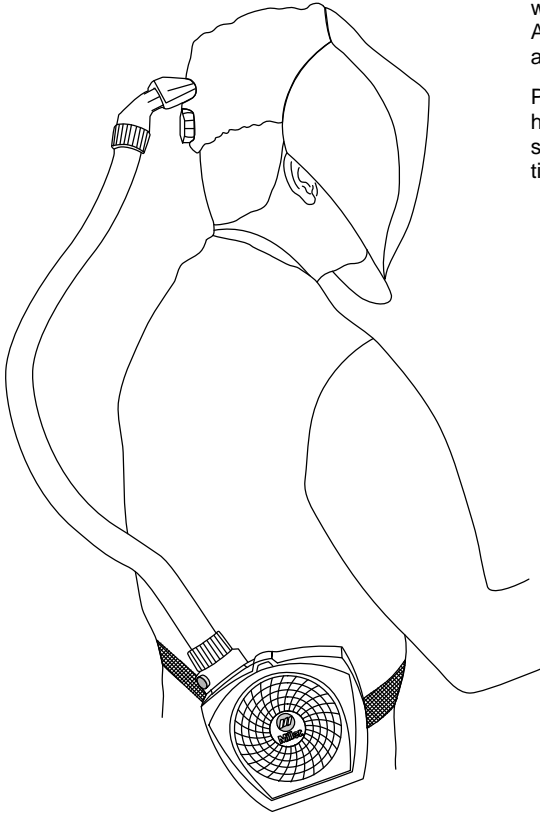

3-10. Changing Hose Length



The hose can be shortened to improve comfort or meet personal requirements.

1 Connector (Blower End)

2 Collar

Carefully pry collar away from connector. Do not remove collar from hose.

Cut hose to desired length. Turn connector counterclockwise into hose. Push collar on connector.

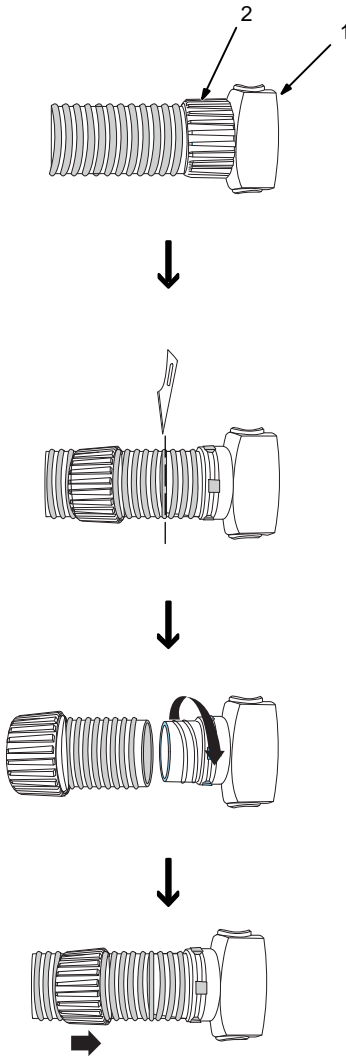

Tools Needed:

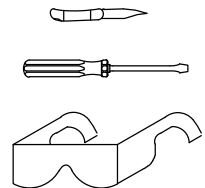

3-11. Replacing Belt



- 1 Screw
- 2 Body Mount
- 3 Belt
- 4 Loops

Remove screw and turn body mount 90° counterclockwise. Remove belt from mount. Install new new belt as shown. Reassemble mount and tighten screw.

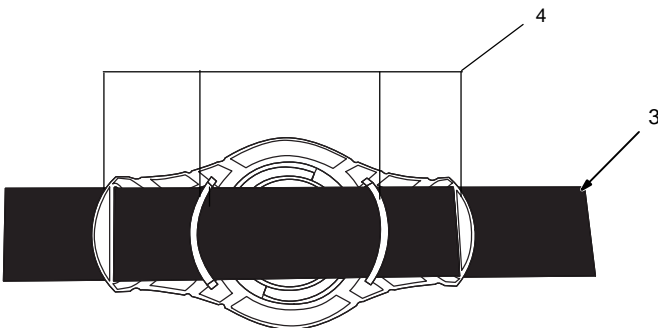
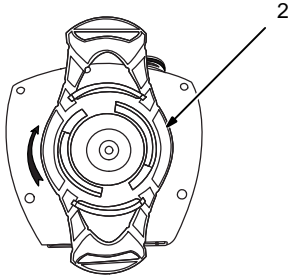
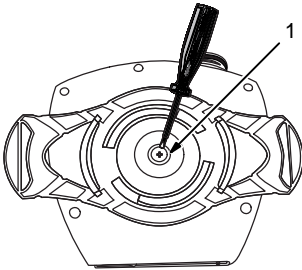

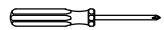

Tools Needed:



phillips

3-12. Maintenance And Storage

-  **Replace damaged or dirty filter. Do not wash filter, clean with compressed air, reverse filter, or reuse dirty filter.**
-  **Never use solvents or abrasive cleaning solutions to clean the helmet cooling system . Keep water and other fluids out of blower assembly.**
-  **Replace shroud after 50 washings. Shroud loses its fire retardant properties with repeated washing.**

For best performance clean the equipment after each use. Use a soft cloth dampened with a mild soap and water solution to wipe all external surfaces clean. Allow to air dry.

Product usage, workplace contamination levels, and other factors affect the life of the filter. Replace filter if air flow is reduced due to a dirty filter (see Section 3-5).

Inspect connecting hose and replace if damaged or if inside of hose is extremely dirty.

If the helmet cooling system will not be used for an extended period, remove the filter and battery and store them in a clean, dry, cool place free of solvent-based vapors.

3-13. Helmet Cooling System Troubleshooting

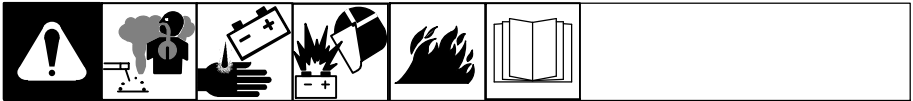

Trouble	Remedy
Blower does not supply air to helmet.	Press On/Off button.
	Dead battery; recharge battery (see Section 3-4).
	Verify battery is properly connected to blower body.
	Verify hose is properly connected.
	Remove blockage from blower outlet and hose.
Blower cannot be turned Off.	Press and hold On/Off button for two to three seconds.
Blower runs for short time even though battery is fully charged.	Be sure battery is properly connected to battery charger.
	Replace filter.
	Replace battery.
Replace charger.	
Battery Level Indicator light is On.	Charge or replace the battery. The blower will operate for about 20 minutes after the light goes on. (The Battery Level indicator lights for several seconds after blower is started.)

Battery run time is too short.	Replace battery.
	Check filter and replace if necessary (see Section 3-5). A clogged filter element reduces battery life.
Air supplied to helmet smells and tastes unusual; eyes and throat irritation.	Continue wearing the helmet cooling system and leave the contaminated area immediately. Check contamination level of filter, and replace filter if necessary.
	Check hose connections to blower and shroud.
	Have Safety Director and an Industrial Hygienist determine if you are using the proper equipment for the work environment.
Blower supplies insufficient air to helmet.	Check hose connections to blower and shroud.
	Remove blockage from blower outlet and/or hose.
	Check filter and replace if necessary (see Section 3-5). A clogged filter element reduces battery life.

SECTION 4 – ADJUSTING HEADGEAR

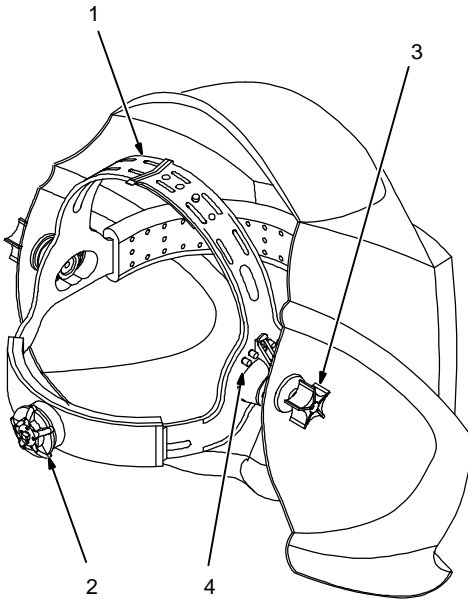
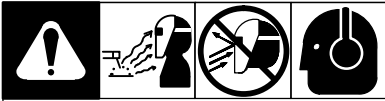

☞ *There are four headgear adjustments: headgear top, tightness, angle adjustment, and distance adjustment.*

1 Headgear Top

Adjusts headgear for proper depth on the head to ensure correct balance and stability.

2 Headgear Tightness

To adjust tightness, rotate the adjusting knob left or right to desired position.

☞ *If adjustment is limited, it may be necessary to remove the comfort cushion.*

3 Distance Adjustment

Adjusts the distance between the face and the lens. To adjust, loosen both outside tension knobs and press inward to free from adjustment slots. Move forward or back to desired position and retighten. (Both sides must be equally positioned for proper vision.)

4 Angle Adjustment

Four pins on the right side of the headband top provide adjustment for the forward tilt of the helmet. To adjust, loosen the right outside tension adjustment knob then lift on the control arm tab and move it to the desired position. Retighten tension adjustment knob.

☞ *When using the back distance adjustment positions, only the back three angle adjustment pins can be used.*

SECTION 5 – PARTS LIST

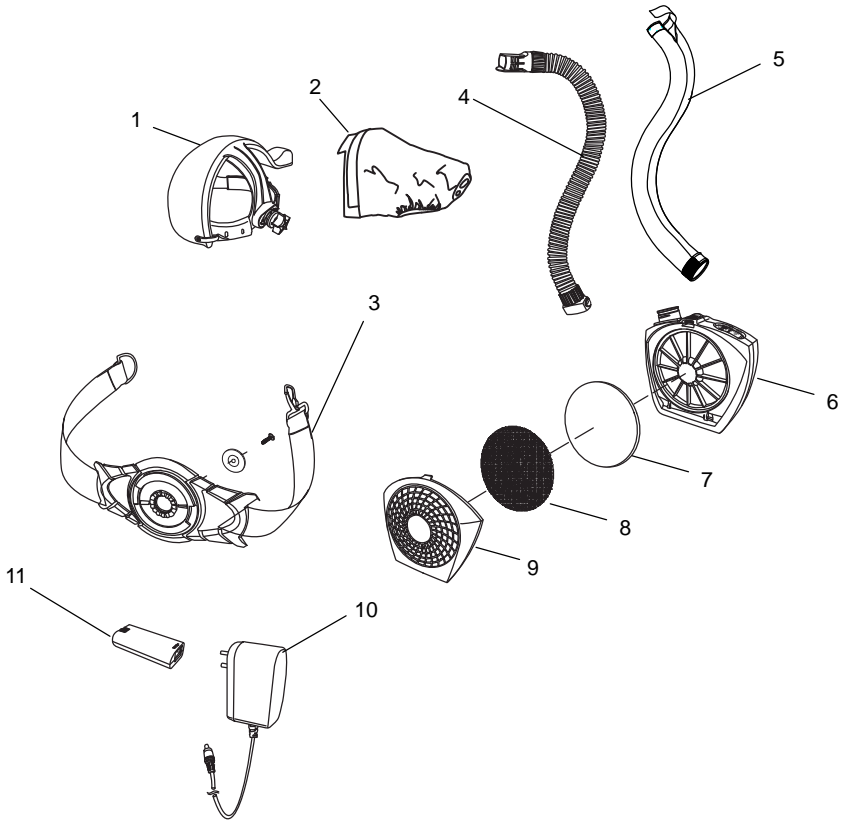

Ref. 805 193

Figure 5-1. CoolBelt Helmet Cooling System

Item No.	Part No.	Description	Quantity
----------	----------	-------------	----------

Figure 5-1. CoolBelt Helmet Cooling System

1	245235	Headgear (Includes)	1
		Replacement O-rings (5 Per Pkg.)	1
	770249	Fabric Headband	1
2	245236	Head Shroud	1
3	245232	Belt	1
4	245231	Hose Assembly	1
5	246964	Cover, Hose	1
6	246965	Blower Unit	1
7	245233	Filter	1
8	247921	Spark Arrestor	1
9	245234	Filter Cover	1
10	245238	Charger	1
11	245237	Battery, Blower	1

SECTION 6 – LIMITED WARRANTY

LIMITED WARRANTY – Subject to the terms and conditions below. Miller Electric Mfg. Co., Appleton, Wisconsin, warrants to its original retail purchaser that the new Miller equipment sold after the effective date of this limited warranty is free of defects in material and workmanship at the time it is shipped by Miller. THIS WARRANTY IS EXPRESSLY IN LIEU OF ALL OTHER WARRANTIES, EXPRESS OR IMPLIED, INCLUDING THE WARRANTIES OR MERCHANTABILITY AND FITNESS.

The helmet cooling system is warranted for one year from the date of purchase. *Proof of purchase is required for warranty transactions so it is imperative that a copy of the original invoice or sales receipt be retained.*

For warranty transactions, contact your Miller Distributor.

Effective January 1, 2014



Visit our website at
www.MillerWelds.com



Miller Electric Mfg. Co.
An Illinois Tool Works Company
1635 West Spencer Street
Appleton, WI 54914 USA