

# Twist-Lock® Devices

## Switched Twist-Lock® and Hubbellock® Enclosures



UL Listed, CSA Certified  
Type 3R and 12K Enclosure Rating

**IP54**  
SUITABILITY

### Switched Enclosure Ready for Twist-Lock® Receptacle Addition

Ideal unit for stockroom. This single unit provides the complete enclosure ready to accept any Hubbell 20 or 30A Twist-Lock receptacle.

Description	Ratings	Catalog Number
Switched Twist-Lock enclosure accommodates any NEMA 2 pole, 3 wire to 4 pole, 5 wire grounding receptacle (sold separately).	Amperage, voltage, and horsepower ratings will be determined by the choice of the NEMA 20 or 30A Twist-Lock receptacle selected.	<b>SETL3</b>
Auxiliary contact.	“Break After Main Break”, 1 set of n/o contacts, 1 set of n/c contacts.	<b>HBLAC1</b>
Auxiliary contact.	“Break Before Main Break”, 1 set of n/o contacts.	<b>HBLAC2</b>

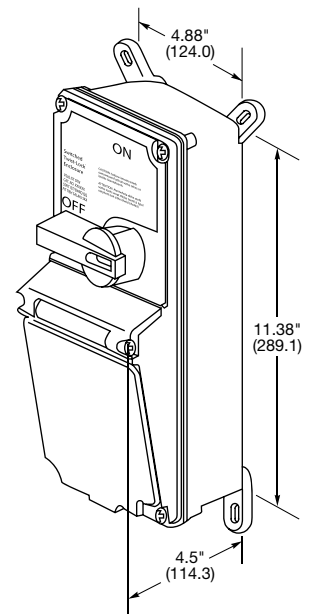

**SETL3**

### Switched Enclosure Complete with Twist-Lock® Receptacle

Completely pre-wired with a Twist-Lock receptacle, these application oriented combinations are available to satisfy your needs.

Description	Amps	Voltage	NEMA Config.	Horsepower	Switched Enclosure	Use Twist-Lock Plug
Switched Twist-Lock enclosure with a pre-wired HBL2720 receptacle.	30	3Ø 240V AC	L15-30R	3	<b>SE2720A</b>	<b>HBL2721</b>
Switched Twist-Lock enclosure with a pre-wired HBL2730 receptacle.	30	3Ø 480V AC	L16-30R	10	<b>SE2730A</b>	<b>HBL2731</b>



**SE2720A**

### Switched Enclosure Ready for Hubbellock® Receptacle Addition

Ideal unit for stockroom. This single unit provides the complete enclosure ready to accept your 30A, 4 wire Hubbellock receptacle choice.

Description	Ratings	Catalog Number
Switched enclosure for use with 3 pole 4 wire 30A Hubbellock receptacle (sold separately).	Amperage, voltage, and horsepower ratings will be determined by the choice of the 4 wire Hubbellock receptacle selected.	<b>SEHBL3</b>
Auxiliary contact.	“Break After Main Break”, 1 set of n/o contacts, 1 set of n/c contacts.	<b>HBLAC1</b>
Auxiliary contact.	“Break Before Main Break”, 1 set of n/o contacts.	<b>HBLAC2</b>



**HBLAC1**

**HBLAC2**

### Replacement Mounting Feet

Description	Catalog Number
For 30A switches.	<b>HBLRFT1<sup>Δ</sup></b>

Note: <sup>Δ</sup> Package of 10 feet and 10 screws.  
See page B-74 for technical information on Switched Safety Enclosures.



**HBLRFT1**

Dimensions in Inches (mm)