

Straight Blade Devices
15A, 125V, 2 Pole, 3 Wire Grounding
Hospital Grade Plug

HUBBELL

Features

- Beveled housing prevents snagging
- Powerful, offsetting cord grips clamp on individual conductors

Ordering Information

Description	Cord Diameter	UPC	Catalog Number
Transparent housing	.230"-.720"(5.8-18.3)	783585179308	HBL8215CT



Listings

UL Listed to UL498 File No. E2186
Certified to CSA, C22.2, No. 42 File 285
Fed. Spec. W-C-596

Specifications

Housing	Clear Polycarbonate
Terminal Retainer	PBT
Blades	.06" (1.5) Brass
Cord Clamp	Nylon
Terminal Screws	Brass
Terminal Clamp	Plated steel
Assembly Screws	Plated steel

Performance

Electrical

Current Interrupting Certified for current interrupting at full rated current
Dielectric Voltage Withstands 2000V AC minimum

Mechanical

Product Identification Ratings are a permanent part of the device
Terminal Accommodation #18-10 AWG
Terminal Identification Terminals identified in accordance with UL 498 and CSA

Environmental

Flammability UL 94 HB or better
IP Suitability IP20
Operating Temperatures Maximum continuous 75°C; minimum -40°C (w/o impact)

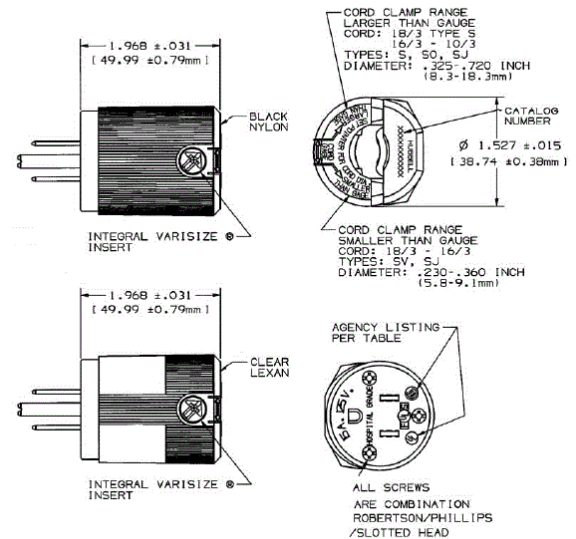

Resources

Customer Use Drawing
eCatalog

Dimensions in Inches (mm)

Hubbell Wiring Device-Kellems • Hubbell Incorporated (Delaware) • 40 Waterview Drive • Shelton, CT 06484

Phone (800) 288-6000 • Fax (800) 255-1031 • Specifications subject to change without notice.

