

STEEL TRUCK DOCKPLATE - SEH-4830

APPROX WEIGHT: 211.16 lbs.
DOES NOT INCLUDE WEIGHT OF POWER OR PACKAGING!!!

ANY ADDITIONS, DELETIONS, OR OMISSIONS MUST BE CORRECTED ON THIS DRAWING AS THIS DRAWING WILL BE CONSIDERED ALL INCLUSIVE

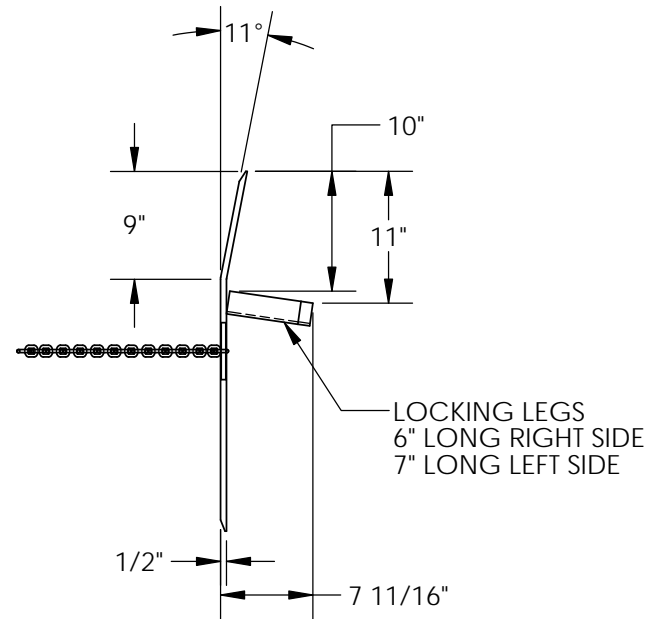
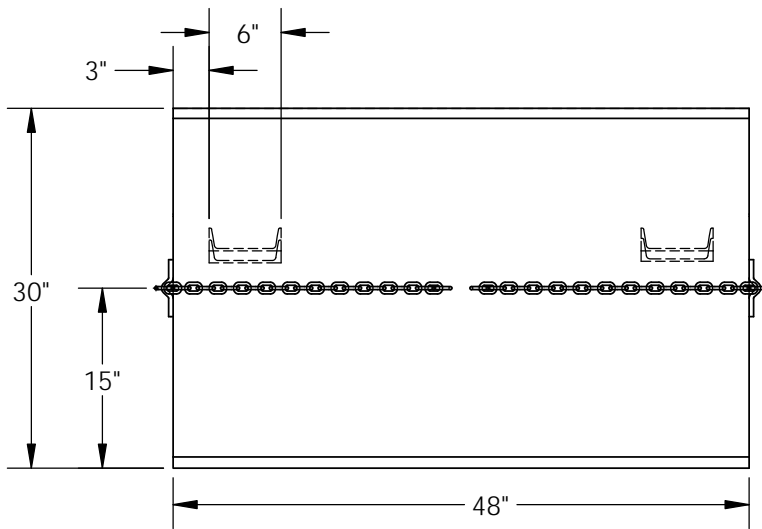

PICK UP CHAINS

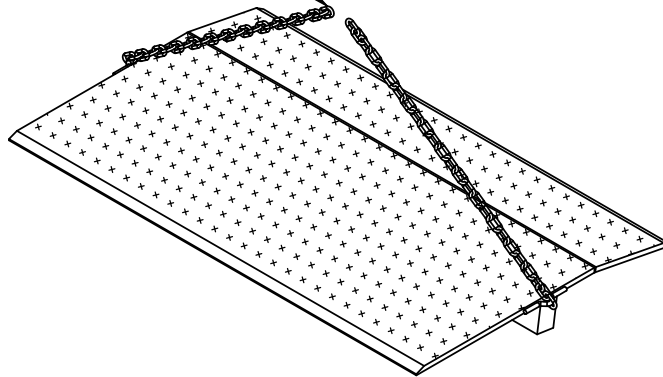

FOR INTERNAL USE ONLY PROJECT SIGN OFF	
SALES	
ENG.	
FAB.	
POWER	

ALL GRAPHICS PROVIDED ARE FOR REFERENCE ONLY. IF CERTAIN DIMENSIONS ARE CRITICAL PLEASE VERIFY THOSE DIMENSIONS WITH YOUR SALESPERSON
DIMENSION TOLERANCE ± 1/4"

STANDARD FEATURES

- MODEL NUMBER IS SEH-4830
- CAPACITY IS 8,800 LBS
- OVERALL WIDTH IS 48"
- OVERALL LENGTH IS 30"
- OVERALL HEIGHT IS 7 11/16"
- DOCKPLATE THICKNESS IS 1/2"
- PICK UP CHAIN IS STANDARD
- LOCKING LEGS ARE 6" WIDE
- LEG LENGTHS ARE 6" RIGHT & 7" LEFT
- CROWN IS 11° & 9" FROM EDGE
- STEEL TREAD PLATE FOR TRACTION

SPECIAL FEATURES

NONE

APPROVAL

I, THE UNDERSIGNED, AGREE THAT THE PRODUCT AS REPRESENTED SATISFIES DESIGN AND DIMENSION REQUIREMENTS. I ALSO ACKNOWLEDGE MY DUTY TO CONFIRM PRODUCT AND INSTALLATION COMPLIANCE WITH ALL APPLICABLE FEDERAL, STATE AND LOCAL REGULATIONS AND STANDARDS.
ALL SPECIAL UNITS ARE NON-RETURNABLE
[] As drawn [] As marked

Signed: _____ Date: _____

LEAD TIME WILL START UPON RECEIPT OF SIGNED APPROVAL DRAWING

DISTRIBUTOR'S NAME:		P.O.#
VESTIL MANUFACTURING		X
DRAWN BY: MTS		W.O.#
DATE: 1/28/14		X
REFERENCE: X	SCALE: 1:16	SALES: X
QUOTED LEAD TIME: X	QUOTE # X	FILE NAME:
		12-007-070