

UL 1686 C1 Pin and Sleeve

60A, 600/250V AC/DC, 3 Pole, 4 Wire

Insulgrip® Pin and Sleeve Receptacle

Features

- Beryllium copper spring maintains high unit pressure on mating sleeves
- Closure cap with neoprene gasket for watertight seal when not in use
- O-Rings- provide a watertight and dust tight seal around pins negating contamination to the wire chamber
- Pin chamber confines arcing within the interior chamber

Ordering Information

| | | |
|---|-----------------------------------|-------------------------------------|
| Description Pin and Sleeve, Watertight Insulgrip Receptacle | UPC 783585010649 | Catalog Number HBL460RS2W |
| Device Color Aluminum | Grounding Style Style 2 | |

Standards

UL Standard 1682
CSA Certified to CSA Spec. C22.2 No. 182.1
UL Listed and CSA Certified Type 4X

Specifications

| | |
|-----------------|------------------------|
| Housing | Epoxy Painted Aluminum |
| Gaskets & Seals | Neoprene |
| Contact Carrier | Thermoset Polyester |
| Pin Spring | Beryllium Copper |
| Cover | Epoxy Painted Aluminum |

Performance

| | |
|--------------------------|---|
| Electrical | |
| Current Interrupting | Certified for current interrupting at full rated current |
| Dielectric Voltage | Withstands 3,000V AC |
| Max. Working Voltage | 600V AC RMS |
| Mechanical | |
| Impact Resistance | Per CSA C22.2, No. 182.1, UL 1682 |
| Product Identification | Identification and ratings are permanently fastened to the device housing |
| Terminal Identification | Terminals identified in accordance with UL 1686(1, 2, 3, Green) |
| Environmental | |
| Flammability (Enclosure) | UL 94V-0 and CSA C22.2 No. 0.17 |
| Moisture Resistance | Type 3, 4, 4X per UL 50E and CSA 22.2, No. 94 |
| Operating Temperatures | Max. Continuous 75°C; Min. -40°C w/o impact -25° with impact |

Accessories

Back Boxes

Online Resources

Customer Use Drawing
eCatalog
Installation Instructions

HUBBELL

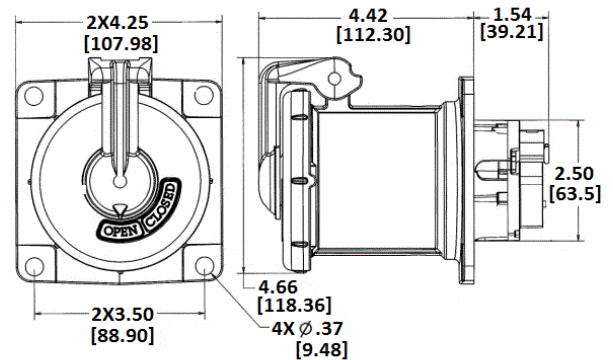

Dimensions in Inches (mm)

Hubbell Wiring Device-Kellems • Hubbell Incorporated (Delaware) • 40 Waterview Drive • Shelton, CT 06484

Phone (800) 288-6000 • Fax (800) 255-1031 • Specifications subject to change without notice.

