

## UL 1686 C1 Pin and Sleeve

30A, 600/250V AC/DC, 3 Pole, 4 Wire

## Insulgrip® Pin and Sleeve Receptacle

### Features

- Beryllium copper spring maintains high unit pressure on mating sleeves
- Closure cap with neoprene gasket for watertight seal when not in use
- O-Rings- provide a watertight and dust tight seal around pins negating contamination to the wire chamber
- Pin chamber confines arcing within the interior chamber

### Ordering Information

<b>Description</b> Pin and Sleeve, Watertight Insulgrip Receptacle	<b>UPC</b> 783585010229	<b>Catalog Number</b> HBL430RS2W
<b>Device Color</b> Aluminum	<b>Grounding Style</b> Style 2	

### Standards

UL Standard 1682  
CSA Certified to CSA Spec. C22.2 No. 182.1  
UL Listed and CSA Certified Type 4X

### Specifications

Housing	Epoxy Painted Aluminum
Gaskets & Seals	Neoprene
Contact Carrier	Thermoset Polyester
Pin Spring	Beryllium Copper
Cover	Epoxy Painted Aluminum

### Performance

<b>Electrical</b>	
Current Interrupting	Certified for current interrupting at full rated current
Dielectric Voltage	Withstands 3,000V AC
Max. Working Voltage	600V AC RMS
<b>Mechanical</b>	
Impact Resistance	Per CSA C22.2, No. 182.1, UL 1682
Product Identification	Identification and ratings are permanently fastened to the device housing
Terminal Identification	Terminals identified in accordance with UL 1686(1, 2, 3, Green)
<b>Environmental</b>	
Flammability (Enclosure)	UL 94V-0 and CSA C22.2 No. 0.17
Moisture Resistance	Type 3, 4, 4X per UL 50E and CSA 22.2, No. 94
Operating Temperatures	Max. Continuous 75°C; Min. -40°C w/o impact -25° with impact

### Accessories

Back Boxes

### Online Resources

Customer Use Drawing  
eCatalog  
Installation Instructions

# HUBBELL

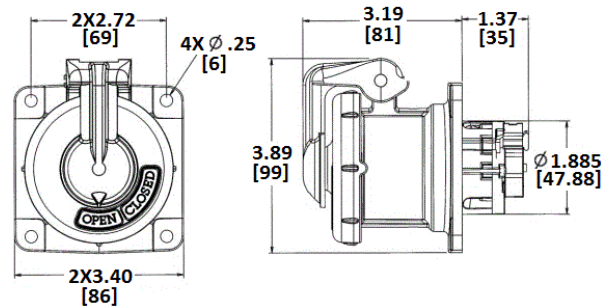

Dimensions in Inches (mm)

Hubbell Wiring Device-Kellems • Hubbell Incorporated (Delaware) • 40 Waterview Drive • Shelton, CT 06484

Phone (800) 288-6000 • Fax (800) 255-1031 • Specifications subject to change without notice.

