

## UL 1686 C1 Pin and Sleeve

30A, 600/250V AC/DC, 3 Pole, 4 Wire

## Insulgrip® Pin and Sleeve Connector

### Features

- Beryllium copper spring maintains high unit pressure on mating sleeves
- Spring-loaded gasket cover provides 4X seal while the device is not in use
- Pin chamber confines arcing within the interior chamber

### Ordering Information

Description	UPC	Catalog Number
Pin and Sleeve, Watertight Insulgrip Connector	783585010205	HBL430CS2W
Device Color	Grounding Style	
Aluminum	Style 2	

### Standards

UL Standard 1682  
CSA Certified to CSA Spec. C22.2 No. 182.1  
UL Listed and CSA Certified Type 4X

### Specifications

Housing	Valox® 357
Connector Shroud	Epoxy Painted Aluminum
Cord Clamps	Rynite® SST35
Clamp Nut	Nickel Plated Brass
Cover Gasket	Neoprene

### Performance

Electrical	
Current Interrupting	Certified for current interrupting at full rated current
Dielectric Voltage Max. Working Voltage	Withstands 3,000V AC 600V AC RMS
Mechanical	
Impact Resistance	Per CSA C22.2, No. 182.1, UL 1682
Product Identification	Identification and ratings are permanently fastened to the device housing
Terminal Identification	Terminals identified in accordance with UL 1686(1, 2, 3, Green)
Environmental	
Flammability (Enclosure)	UL 94V-0 and CSA C22.2 No. 0.17
Moisture Resistance	Type 3, 4, 4X per UL 50E and CSA 22.2, No. 94
Operating Temperatures	Max. Continuous 75°C; Min. -40°C w/o impact -25° with impact

### Accessories

Cord Clamps and Locking Ring  
Liquidtight Adapters

### Online Resources

Customer Use Drawing  
eCatalog  
Installation Instructions

# HUBBELL

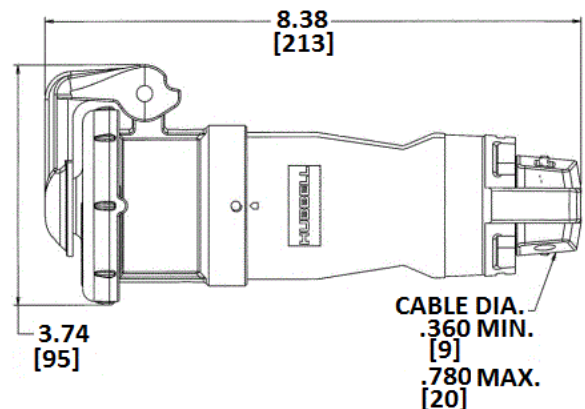

Dimensions in Inches (mm)

Hubbell Wiring Device-Kellems • Hubbell Incorporated (Delaware) • 40 Waterview Drive • Shelton, CT 06484

Phone (800) 288-6000 • Fax (800) 255-1031 • Specifications subject to change without notice.

