

# RLW

REVALUME™ LINEAR WRAP

DATE: \_\_\_\_\_ LOCATION: \_\_\_\_\_  
 TYPE: \_\_\_\_\_ PROJECT: \_\_\_\_\_  
 CATALOG #: \_\_\_\_\_

## FEATURES

- Uninterrupted ribbon of light for single or row mount applications
- Optional integral emergency battery pack
- Decorative injection molded ABS material endcaps
- Modular replaceable LED boards and driver accessible for future maintenance or upgrades
- Surface mount, stem mount or cable mount
- DLC® (Design Lights Consortium) Qualified - see [www.designlights.org](http://www.designlights.org)



## CONTROL TECHNOLOGY



### RELATED PRODUCTS

- ◉ [Reverie™ Decorative Low Bay](#)
- ◉ [Multipurpose Linear](#)

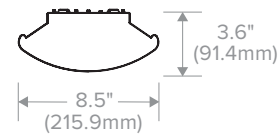

END VIEW (ALL SIZES)

## SPECIFICATIONS

### CONSTRUCTION

- Housing, and wireway are formed from code-gauge steel
- Back of housing knockouts are provided for electrical access and mounting
- Decorative injection molded ABS material endcaps

### SHIELDING

- Round frosted acrylic lens offers a smooth appearance and even light distribution

### FINISH

- White painted parts are treated with a five-stage phosphate bonding process and finished with high reflectance baked enamel

### ELECTRICAL

- Long-life LEDs are rated for 60,000 hours at L80 lumen maintenance
- Driver options include fixed output for on/off function, step dimming (high/low/off), or continuous 0–10V dimming
- Superior drivers and long-life LEDs provide quality illumination for prolonged service life. Drivers < 10% THD at 120V, power factor > 0.95

### CONTROLS

- Optional SpectraSync™ offers two modes of tunable white solutions and integrates seamlessly into a variety of control systems
- NX Distributed Intelligence™ provides options for standalone and networked integrated sensor with wired or wireless connectivity for NX system deployments

### TECHNOLOGY

- SpectraSAFE™ is a scalable, cloud-enabled and lighting-based wireless video security solution for interior commercial and industrial applications

### CERTIFICATION

- All luminaires are built to UL 1598 and 2108 standards, and bear appropriate CSA labels.
- Damp location labeling is standard
- CSA certified to UL 924 standards with battery pack or DTS (Dimming Bypass Module) options
- Adheres to LM79, LM80, and TM21 industry standards

### CERTIFICATION (CONTINUED)

- The DTS, Dimming Bypass Module, is for emergency circuit control loads including sensors and wireless systems CSA certified to UL 924. See page 6 for wiring diagram. [Link to Dimming Bypass Module Specification sheet](#)
- This product qualifies as a “designated country construction material” per FAR 52.225-11 Buy American–Construction Materials under Trade Agreements effective 06/01/2020. [See Buy American Solutions](#)

### WARRANTY

- 5 year warranty
- See [HLI Standard Warranty](#) for additional information

KEY DATA	
Lumen Range	1513–14711
Wattage Range	12–112
Efficacy Range (LPW)	115–144
Reported Life (Hours)	L80/60,000

**ORDERING GUIDE**

Example: RLW4-40ML-FAW-EDU

CATALOG # \_\_\_\_\_

RLW		Color Temp		Nominal Lumens <sup>2</sup>		FA	W	
Model	Size					Shielding	Distribution	
RLW Revalume™ Linear Wrap	2 2'	30	3000K	XW	4' (2700), 8' (5400) <sup>3</sup>	FA Frosted Acrylic	W Wide	
	4 4'	35	3500K	VW	2' (1600), 4' (3400), 8' (6800) <sup>3</sup>			
	8 8'	40	4000K	MW	2' (2200), 4' (3800), 8' (7700) <sup>3</sup>			
		50	5000K	LW	2' (2600), 4' (4200), 8' (8500) <sup>3</sup>			
		2750T	2700K–5000K SpectraSync™ Tunable White <sup>1</sup>		ML			2' (3400), 4' (5300), 8' (9800) <sup>3</sup>
		2765T	2700K–6500K SpectraSync™ Tunable White <sup>1</sup>		HL			2' (3800), 4' (6000), 8' (11,800) <sup>4</sup>
			VL	2' (4500), 4' (7800), 8' (14,200) <sup>4</sup>				

Driver	Voltage	Options	Control Options
E Fixed Output	U 120–277V	ELL14 Emergency Battery Pack, 1400 Lumens <sup>5</sup>	<b>NX Standalone</b>
ED 0-10V Dimming	347 347V	GTD Generator Transfer Device <sup>6</sup>	NXOS NX, PIR BT Occupancy/Daylight Sensor, Round Ceiling Mount <sup>11</sup>
ED1 0-10V 1% Dimming		DTS Dimming Bypass Module <sup>7</sup>	<b>Third-Party Control Options</b>
EDD 0-10V Dim-to-Dark		GLR Fast Blow Fuse	LVR Lutron Vive Integral Fixture Control DFCSJ-OEM-RF (RF only) <sup>12,13,14</sup>
ESD Step Dimming		INT Intermediate (provides ends with wiring access for continuous row mounting) <sup>8</sup>	LVS Lutron Vive Integral Fixture Control DFCSJ-OEM-OCC (RF with daylight and occupancy sensing) <sup>12,13,14</sup>
LUTH Hi-lume 1% EcoSystem LED driver with Soft-on, Fade-to-Black dimming technology		EOR End of Row (provides end wiring access for continuous row mounting)	ODPG Occupancy and Daylight Sensors w/ Grouping, Philips SNS200 <sup>12,14</sup>
LUT5 5-Series EcoSystem LED Driver		SAF SpectraSAFE™ Integrated Surveillance Lighting System <sup>10</sup>	
DALIP DALI Power Bus <sup>9</sup>			

**Accessories (Order Separately)**

RLWWG2	2' Wire Guard
RLWWG4	4' Wire Guard
S18	18" Stem, Canopy
SS18	18" Swivel Stem–45° Swivel
CM24SCF3-KIT	24" Adjustable Cable Mounting Kit, 3-wire feed
CM48SCF3-KIT	48" Adjustable Cable Mounting Kit, 3-wire feed

Notes:

- 1 Only available with ED driver
- 2 Nominal Lumens. Refer to performance tables for exact values and available lumen outputs for fixture size
- 3 RLW4' & RLW8' lumen packages XW - ML qualified up to 40°C
- 4 RLW4' & RLW8' lumen packages HL & VL qualified up to 35°C
- 5 For compatibility with Dual-Lite LiteGear® inverters in lieu of installed battery pack, contact Hubbell Lighting representative. Not available with 2'
- 6 Available for universal voltage and fixed output driver options only
- 7 For emergency circuit control loads including sensors and wireless systems CSA certified to UL 924. Only available with 0-10V drivers. Universal voltage only. See page 6 for wiring diagram
- 8 Suspension support required at every fixture coupling; see [Mounting Accessories Guide](#)
- 9 DALIP only available when LVS, LVR or ODPG control options are selected
- 10 Not available with Control Options. Not available in 347. Not available with through wiring
- 11 Only available with ED and ED1 drivers. Universal voltage only
- 12 LVS, LVR and ODPG only available with DALIP driver option
- 13 VIVE is a trademark of Lutron Electronics Co., Inc
- 14 Not available with SpectraSync (2750T or 2765T)

DATE: \_\_\_\_\_ LOCATION: \_\_\_\_\_  
 TYPE: \_\_\_\_\_ PROJECT: \_\_\_\_\_  
 CATALOG #: \_\_\_\_\_

**CONTROLS**

**NX Distributed Intelligence™ Lighting Controls:**

Supports both indoor and outdoor applications in a variety of deployment options- wired, wireless, hybrid. Integrates with and enables a wide array of luminaires including those with SpectraSync Color Tuning Technology.



NX INTEGRATED CONTROLS REFERENCE									
NX Option	Sensor	Networkable	Scheduling	Occupancy	Daylight Harvesting	0-10V Dimming	On/off Control	Bluetooth® App Programming	Commissioning
<b>NX Standalone</b>									
<a href="#">NXOS</a>	NXSMP-OMNI	No	Yes	Yes	Yes	Yes	Yes	Yes	On-site

**SpectraSync™ Color Tuning Technology:**

Control your space based on the needs of the application, specific activities throughout the day and preferences of the occupants with distinct SpectraSync™ Color Tuning Technologies.



SPECTRASYNC COLOR TUNING TECHNOLOGY		
Mode	Kelvin Range	Description
Tunable White	2700K-5000K 2700K-6500K	Offers users the ability to tailor CCT to their personal preference, enhancing task visibility, material and colors or the aesthetics of the space

**SpectraSAFE™ Integrated Surveillance Lighting System**

**Technical Features**

- High resolution 1080p full HD camera
- 2.8mm lens / 140° field of view
- IR emitter for low / no-light conditions
- [Multiple wiring configurations available](#)
- Supports 2-way audio communication
- Supports 2.4GHz WPA-PSK/WPA2-PSK Wi-Fi
- Data encrypted using AES 256 standard
- Low power consumption (2-5W)
- Transmissions secured using Open TLS / SSL

**Software & Support**

- Free Android, iOS and web-based app
- Versatile and supports multiple applications
- Multi-tenant web-based camera application
- Phone and in-app chat technical support
- Scalable cloud services and video storage
- Supported by a 5-year warranty

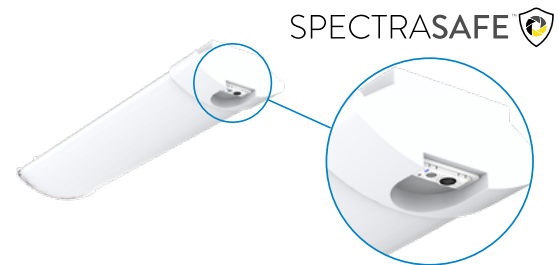

**SPECTRASAFE WIRING DIAGRAM**

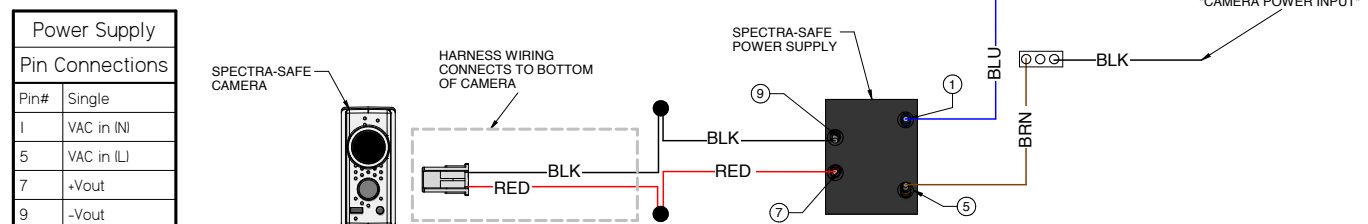

**DELIVERED LUMENS**

FIXTURE	COLOR	LUMENS	WATTS	LPW
RLW2-VW	3000K	1513	11.6	130
	3500K	1541	11.6	133
	4000K	1559	11.6	134
	5000K	1612	11.6	139
RLW2-MW	3000K	2020	16.3	124
	3500K	2057	16.3	126
	4000K	2082	16.3	128
	5000K	2152	16.3	132
RLW2-LW	3000K	2553	22.1	116
	3500K	2600	22.1	118
	4000K	2631	22.1	119
	5000K	2720	22.1	123
RLW2-ML	3000K	3297	26.6	124
	3500K	3357	26.6	126
	4000K	3397	26.6	128
	5000K	3511	26.6	132
RLW2-HL	3000K	3594	29.5	122
	3500K	3660	29.5	124
	4000K	3704	29.5	126
	5000K	3828	29.5	130
RLW2-VL	3000K	4354	37.2	117
	3500K	4434	37.2	119
	4000K	4487	37.2	121
	5000K	4638	37.2	125
RLW4-XW	3000K	2711	19.5	140
	3500K	2673	19.4	138
	4000K	2705	19.4	139
	5000K	2755	19.4	142
RLW4-VW	3000K	3275	25.2	130
	3500K	3335	25.2	132
	4000K	3375	25.2	134
	5000K	3488	25.2	138
RLW4-MW	3000K	3854	28.8	134
	3500K	3925	28.8	136
	4000K	3972	28.8	138
	5000K	4106	28.8	143
RLW4-LW	3000K	4174	33.9	123
	3500K	4251	33.9	125
	4000K	4302	33.9	127
	5000K	4447	33.9	131
RLW4-ML	3000K	5128	40.4	127
	3500K	5222	40.4	129
	4000K	5285	40.4	131
	5000K	5462	40.4	135

DATE: \_\_\_\_\_ LOCATION: \_\_\_\_\_

TYPE: \_\_\_\_\_ PROJECT: \_\_\_\_\_

CATALOG #: \_\_\_\_\_

**DELIVERED LUMENS**

FIXTURE	COLOR	LUMENS	WATTS	LPW
RLW4-HL	3000K	5553	48.1	115
	3500K	5655	48.1	118
	4000K	5723	48.1	119
	5000K	5915	48.1	123
RLW4-VL	3000K	7510	55.9	135
	3500K	7645	55.9	137
	4000K	7767	55.9	139
	5000K	8024	55.7	144
RLW8-XW	3000K	4989	39	128
	3500K	5080	38.8	131
	4000K	5141	38.8	132
	5000K	5314	38.8	137
RLW8-VW	3000K	6397	50.4	127
	3500K	6514	50.4	129
	4000K	6592	50.4	131
	5000K	6814	50.4	135
RLW8-MW	3000K	7157	57.6	124
	3500K	7288	57.6	127
	4000K	7375	57.6	128
	5000K	7623	57.6	132
RLW8-LW	3000K	8349	67.8	123
	3500K	8502	67.8	125
	4000K	8604	67.8	127
	5000K	8893	67.8	131
RLW8-ML	3000K	9525	80.8	118
	3500K	9700	80.8	120
	4000K	9816	80.8	121
	5000K	10146	80.8	126
RLW8-HL	3000K	11106	96.2	115
	3500K	11310	96.2	118
	4000K	11446	96.2	119
	5000K	11830	96.2	123
RLW8-VL	3000K	13811	111.8	124
	3500K	14064	111.8	126
	4000K	14233	111.8	127
	5000K	14711	111.4	132

**DIMENSIONS**

**FIXTURE HEIGHT (ALL SIZES)**

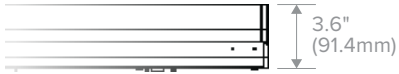

**END VIEW (ALL SIZES)**

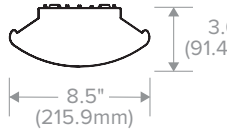

**KOs (ALL SIZES)**

- 0.25" (1/4") KOs are for CM (Cable Mount) Kits
- 0.875" (7/8") KOs are for wiring and stem mounting

**2' SINGLE ASSEMBLY**

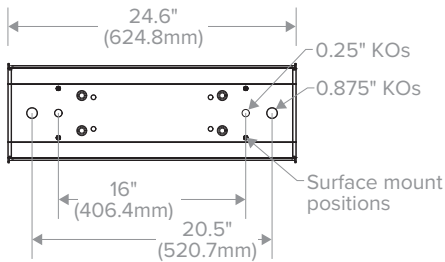

**2' INTERMEDIATE ASSEMBLY**

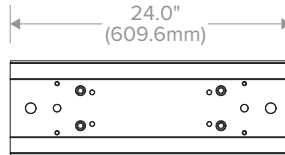

**2' END OF ROW ASSEMBLY**

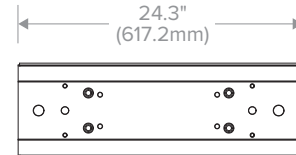

**4' SINGLE ASSEMBLY**

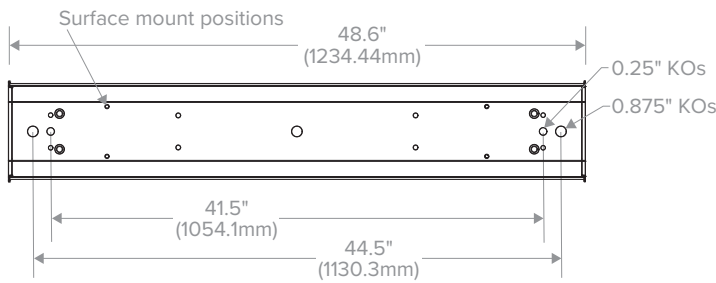

**4' INTERMEDIATE ASSEMBLY**

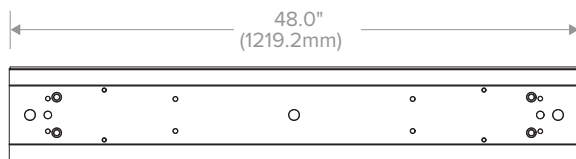

**4' END OF ROW ASSEMBLY**

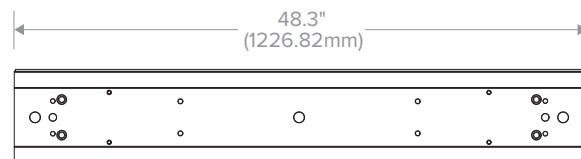

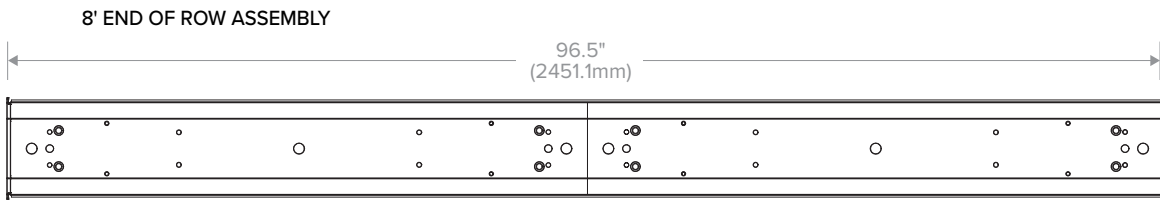
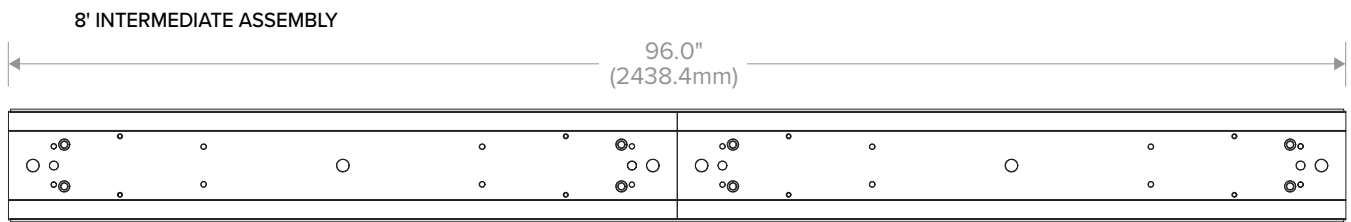
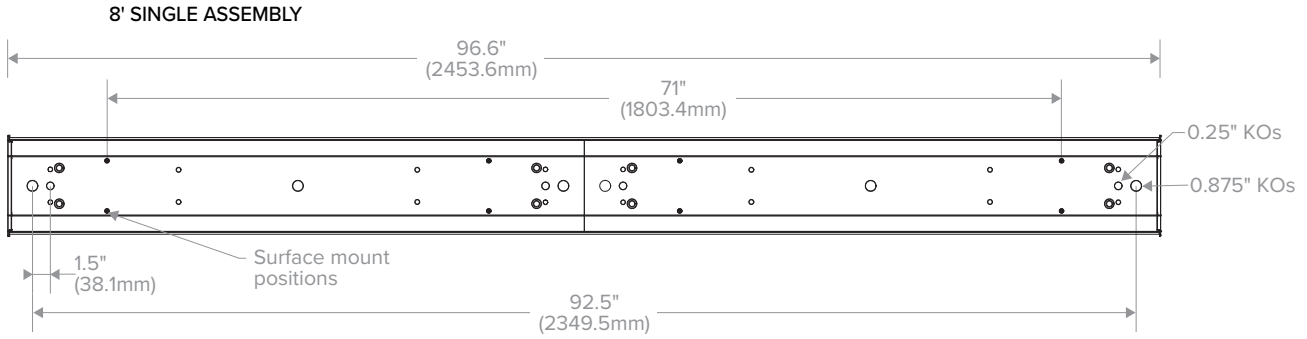

**ADDITIONAL INFORMATION**

**DTS WIRING DIAGRAM (0-10V DIMMING DRIVER SHOWN)**

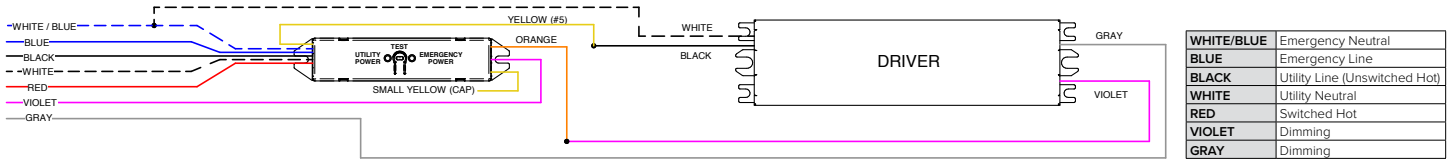

**PHOTOMETRY**

**RLW4-30XW-FAW-EDU**

**LUMINAIRE DATA**

Test No.	18.01231
Description	Revalume Linear Surface, Wraps 8.5" x 48" with frosted acrylic refractor
Delivered Lumens	2502
Watts	19.5
Efficacy	128
Mounting	Surface
Spacing Criterion	0° = 1.21 90° = 1.25

**ZONAL LUMEN SUMMARY**

Zone	Lumens	% Lamp	% Fixt.
0-30	646	25.8	25.8
0-40	1051	42.0	42.0
0-60	1841	73.6	73.6
0-90	2431	97.1	97.1
0-180	2502	100.0	100.0

**POLAR GRAPH**

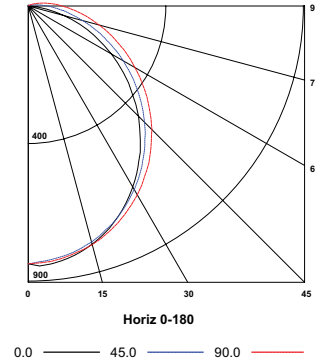

**RLW4-35VW-FAW-EDU**

**LUMINAIRE DATA**

Test No.	18.01221
Description	Revalume Linear Surface, Wraps 8.5" x 48" with frosted acrylic refractor
Delivered Lumens	3234
Watts	40.4
Efficacy	128
Mounting	Surface
Spacing Criterion	0° = 1.21 90° = 1.25

**ZONAL LUMEN SUMMARY**

Zone	Lumens	% Lamp	% Fixt.
0-30	1263	25.8	25.8
0-40	2056	42.0	42.0
0-60	3607	73.6	73.6
0-90	4755	97.0	97.0
0-180	4901	100.0	100.0

**POLAR GRAPH**

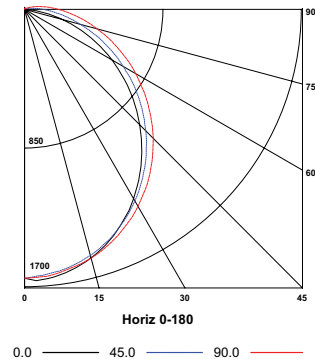

**RLW4-50VL-FAW-EDU**

**LUMINAIRE DATA**

Test No.	18.01234
Description	Revalume Linear Surface, Wraps 8.5" x 48" with frosted acrylic refractor
Delivered Lumens	7476
Watts	55.7
Efficacy	134
Mounting	Surface
Spacing Criterion	0° = 1.21 90° = 1.25

**ZONAL LUMEN SUMMARY**

Zone	Lumens	% Lamp	% Fixt.
0-30	1914	25.6	25.6
0-40	3118	41.7	41.7
0-60	5479	73.3	73.3
0-90	7241	96.9	96.9
0-180	7476	100.0	100.0

**POLAR GRAPH**

