

LED



create**change**



FEATURES

- Two attractive architectural center lens choices
- High efficiency acrylic center lens features linear prisms for high performance without pixelation
- Appropriate for offices, schools, medical, and public spaces
- High performance reflector with matte white paint standard
- 60,000 hour LEDs at L80 (up to 150,000 projected life) for reduced maintenance
- 83 CRI standard or optional 90 CRI for color sensitive applications
- Four LED color choices
- Five lumen packages
- Multiple driver options to satisfy different applications
- LED modules and electrical accessible from below
- Optional architecturally styled integration of daylight and occupancy sensor(s)
- Wireless ZigBee® radio enabled option
- QR code traceability
- Integral battery pack optional on most models
- Compatible with Dual-Lite inverters
- Recessed, surface or cable mount
- Air return option
- DesignLights Consortium® (DLC) qualified with many configurations qualifying for DLC Premium
- Five year warranty (Terms and Conditions apply)

PROJECT INFORMATION

Project Name _____

Type _____

Catalog No. _____

Date _____

CONSTRUCTION

Luminaire housing, reflectors and end caps are die formed code gauge cold rolled steel. High transmission extruded acrylic enclosed lens features linear prisms with custom frost for high efficacy without pixelation.

SHIELDING

Removable lens for easy access to LED module and electrical components.

FINISH

All reflective surfaces are finished after fabrication with unique formula high reflectivity matte white paint for soft, uniform indirect illumination.

INSTALLATION

An access plate is furnished with each luminaire for fast wiring access without the necessity to open the fixture or wireway.

CEILING COMPATIBILITY

Luminaire fits recessed exposed Grid ceilings (G); four integral NEC compliant T-bar clips are standard. Can be placed in Slot Grid (SG) style ceiling with regress 3/8" above ceiling plane. A Flange Kit (FK) accessory is available for recessed hard ceiling applications. Surface Mount (SM) option allows placement below ceiling plane. Cable Mount (CM) option allows product suspension below ceiling plane.

CERTIFICATION

All luminaires are built to UL1598 and 2108 standards, and bear appropriate CSA labels. Damp location label standard. Emergency-equipped fixtures labeled UL 924 and Dry Location unless specified. Adheres to LM79, LM80, and TM21 industry standards. DesignLights Consortium® (DLC) and DLC Premium qualified. Please refer to the DLC website for specific product qualifications at www.designlights.org.

IC RATING

IC label is standard for recessed products. Note that IC label is void if product is installed on site with a combination of both battery pack plus through wiring or for air return fixtures.

WARRANTY

Five year warranty (Terms and Conditions apply).

ORDERING INFORMATION

EXAMPLE LCAT22-35HLG-ESDU

LCAT		22											
MODEL	CRI	COLOR TEMP		CEILING TYPE		AIR FUNCTION		VOLTAGE		OPTIONS			
LCAT LED Contemporary Architectural Troffer	Blank >80 9 >90	30 3000K 35 3500K 40 4000K 50 5000K	G Grid Lay-in ¹ SM Surface Mount ² CM Cable Suspended Mount ^{2,3}	Blank Static A Air Return Side Slots	U 120V-277V 347 347V	ELL14 Emergency Battery Pack Installed, 1400 Lumens ^{5,6} C388 3-Wire Flex C488 4-Wire Flex C588 5-Wire Flex GLR Fast Blow Fuse NYC NYC Compliant EOR End of Row (SM and CM only. Provides end wiring access for continuous row mounting.) ² INT Intermediate (SM and CM only. Provides ends with wiring access for continuous row mounting.) ² CP Chicago Plenum ODP Occupancy and Daylight Sensors, Philips ^{6,7} ZRE Wireless ZigBee® radio enabled ⁹							
SIZE		LUMEN OUTPUT		SHIELDING		DRIVER							
22 2' x 2'		VW Very Low Watt VWHE Very Low Watt High Efficacy MW Medium Low Watt MWHE Medium Low Watt High Efficacy LW Low Watt ML Medium Lumen MLHE Medium Lumen High Efficacy HL High Lumen HLHE High Lumen High Efficacy VL Very High Lumen VLHE Very High Lumen High Efficacy		Blank Curve R Rectangular		E Fixed Output ESD Step Dimming ^{6,6} ED 0-10V Dimming ED1 0-10V 1% Dimming LUTH Lutron H Series 1% Dimming ^{6,6} LUTS Lutron S Series 5% Dimming ^{6,6}							
ACCESSORIES (ORDER SEPARATELY)													
FK22 2' x 2' Single Flange Kit (Shipped separately) CM48Y2SC3F-KIT 48" Cable Mount Kit for 2' wide Cable Mount fixtures, 3 Wire		See Product Availability Table on following pages.											

	VW	XWHE	MW	VWHE	LW	ML	MLHE	HL	HLHE	VL	VLHE
E	X	X	X	X	X	X	X	X	X	X	X
ED	X	X	X	X	X	X	X	X	X	X	X
ED1	X	X	X	X	X	X	X	X	X	X	X
ESD						X		X		X	
LUTS			X		X	X					
LUTH			X		X	X					
347	X		X		X	X		X		X	

¹ For drywall, order G with Flange Kit Accessory.
² Not available with Air Return (A) air function
³ Order hanger accessories separately.
⁴ Limitations apply based on lumen packages (see Driver Table).
⁵ For compatibility with Dual-Lite LiteGear® inverters, contact Hubbell Lighting Representative.
⁶ Not available in 347V
⁷ Only available with 0-10V Dimming (ED) Driver Option.
⁸ Only available with 0-10V Dimming (ED, ED1) Driver Options.
 For questions about configuration options, contact Hubbell Representative.
 Page 1/5 Rev. 01/26/17

Product Availability 80 CRI					Product Availability 90 CRI				
Lumen Package	Shielding	Lumens	Input Watts	LPW	Lumen Package	Shielding	Lumens	Input Watts	LPW
LCAT22-30VW	Curve	1567	13.6	115	LCAT22-930VW	Curve	1342	13.4	100
LCAT22-30VWx-R	Rectangle	1545	13.4	115	LCAT22-930VWx-R	Rectangle	1313	13.4	98
LCAT22-30VWHE	Curve	1530	12.6	121					
LCAT22-35VW	Curve	1614	13.6	119	LCAT22-935VW	Curve	1371	13.4	102
LCAT22-35VWx-R	Rectangle	1597	13.4	119	LCAT22-935VWx-R	Rectangle	1341	13.4	100
LCAT22-35VWHE	Curve	1576	12.6	125					
LCAT22-40VW	Curve	1639	13.6	121	LCAT22-940VW	Curve	1400	13.4	104
LCAT22-40VWx-R	Rectangle	1623	13.4	121	LCAT22-940VWx-R	Rectangle	1370	13.4	102
LCAT22-40VWHE	Curve	1600	12.6	127					
LCAT22-50VW	Curve	1785	13.6	131	LCAT22-950VW	Curve	1492	13.4	111
LCAT22-50VWx-R	Rectangle	1666	13.4	124	LCAT22-950VWx-R	Rectangle	1459	13.4	109
LCAT22-50VWHE	Curve	1743	12.6	138					
LCAT22-30MW	Curve	2049	18.0	114	LCAT22-930MW	Curve	1744	17.7	99
LCAT22-30MWx-R	Rectangle	2017	17.7	114	LCAT22-930MWx-R	Rectangle	1714	17.7	97
LCAT22-30MWHE	Curve	2010	16.5	122					
LCAT22-35MW	Curve	2110	18.0	117	LCAT22-935MW	Curve	1781	17.7	101
LCAT22-35MWx-R	Rectangle	2085	17.7	118	LCAT22-935MWx-R	Rectangle	1750	17.7	99
LCAT22-35MWHE	Curve	2070	16.5	125					
LCAT22-40MW	Curve	2143	18.0	119	LCAT22-940MW	Curve	1819	17.7	103
LCAT22-40MWx-R	Rectangle	2118	17.7	120	LCAT22-940MWx-R	Rectangle	1788	17.7	101
LCAT22-40MWHE	Curve	2102	16.5	127					
LCAT22-50MW	Curve	2334	18.0	130	LCAT22-950MW	Curve	1938	17.7	109
LCAT22-50MWx-R	Rectangle	2174	17.7	123	LCAT22-950MWx-R	Rectangle	1905	17.7	108
LCAT22-50MWHE	Curve	2289	16.5	139					
LCAT22-30LW	Curve	2689	22.6	119	LCAT22-930LW	Curve	2286	22.6	101
LCAT22-30LWx-R	Rectangle	2661	22.6	118	LCAT22-930LWx-R	Rectangle	2263	22.6	100
LCAT22-35LW	Curve	2770	22.6	123	LCAT22-935LW	Curve	2339	22.6	103
LCAT22-35LWx-R	Rectangle	2752	22.6	122	LCAT22-935LWx-R	Rectangle	2311	22.6	102
LCAT22-40LW	Curve	2813	22.6	124	LCAT22-940LW	Curve	2393	22.6	106
LCAT22-40LWx-R	Rectangle	2795	22.6	124	LCAT22-940LWx-R	Rectangle	2361	22.6	104
LCAT22-50LW	Curve	3063	22.6	136	LCAT22-950LW	Curve	2527	22.6	112
LCAT22-50LWx-R	Rectangle	2870	22.6	127	LCAT22-950LWx-R	Rectangle	2515	22.6	111
LCAT22-30ML	Curve	3320	28.7	116	LCAT22-930ML	Curve	2821	28.7	98
LCAT22-30MLx-R	Rectangle	3267	28.7	114	LCAT22-930MLx-R	Rectangle	2778	28.7	97
LCAT22-30MLHE	Curve	3293	27.6	119					
LCAT22-35ML	Curve	3420	28.7	119	LCAT22-935ML	Curve	2888	28.7	101
LCAT22-35MLx-R	Rectangle	3378	28.7	118	LCAT22-935MLx-R	Rectangle	2836	28.7	99
LCAT22-35MLHE	Curve	3392	27.6	123					
LCAT22-40ML	Curve	3473	28.7	121	LCAT22-940ML	Curve	2954	28.7	103
LCAT22-40MLx-R	Rectangle	3431	28.7	120	LCAT22-940MLx-R	Rectangle	2897	28.7	101
LCAT22-40MLHE	Curve	3442	27.6	125					
LCAT22-50ML	Curve	3781	28.7	132	LCAT22-950ML	Curve	3121	28.7	109
LCAT22-50MLx-R	Rectangle	3522	28.7	123	LCAT22-950MLx-R	Rectangle	3086	28.7	108
LCAT22-50MLHE	Curve	3751	27.6	136					
LCAT22-30HL	Curve	3599	31.8	113	LCAT22-930HL	Curve	3123	31.8	98
LCAT22-30HLx-R	Rectangle	3543	31.6	112	LCAT22-930HLx-R	Rectangle	3012	31.6	95
LCAT22-30HLHE	Curve	3497	27.8	126					

Product Availability 80 CRI					Product Availability 90 CRI				
Lumen Package	Shielding	Lumens	Input Watts	LPW	Lumen Package	Shielding	Lumens	Input Watts	LPW
LCAT22-35HL	Curve	3707	31.8	117	LCAT22-935HL	Curve	3190	31.8	100
LCAT22-35HLx-R	Rectangle	3664	31.6	116	LCAT22-935HLx-R	Rectangle	3076	31.6	97
LCAT22-35HLHE	Curve	3616	27.8	130					
LCAT22-40HL	Curve	3764	31.8	118	LCAT22-940HL	Curve	3259	31.8	102
LCAT22-40HLx-R	Rectangle	3721	31.6	118	LCAT22-940HLx-R	Rectangle	3142	31.6	99
LCAT22-40HLHE	Curve	3671	27.8	132					
LCAT22-50HL	Curve	4099	31.8	129	LCAT22-950HL	Curve	3471	31.8	109
LCAT22-50HLx-R	Rectangle	3820	31.6	121	LCAT22-950HLx-R	Rectangle	3347	31.6	106
LCAT22-50HLHE	Curve	3769	27.8	136					
LCAT22-30VL	Curve	4270	38.6	111	LCAT22-930VL	Curve	4289	38.9	110
LCAT22-30VLx-R	Rectangle	4432	40.4	110	LCAT22-930VLx-R	Rectangle	3767	40.4	93
LCAT22-30VLHE	Curve	4257	34.6	123					
LCAT22-35VL	Curve	4398	38.6	114	LCAT22-935VL	Curve	4381	38.9	113
LCAT22-35VLx-R	Rectangle	4583	40.4	113	LCAT22-935VLx-R	Rectangle	3848	40.4	95
LCAT22-35VLHE	Curve	4401	34.6	127					
LCAT22-40VL	Curve	4466	38.6	116	LCAT22-940VL	Curve	4476	38.9	115
LCAT22-40VLx-R	Rectangle	4655	40.4	115	LCAT22-940VLx-R	Rectangle	3930	40.4	97
LCAT22-40VLHE	Curve	4470	34.6	129					
LCAT22-50VL	Curve	4863	38.6	126	LCAT22-950VL	Curve	4767	38.9	123
LCAT22-50VLx-R	Rectangle	4779	40.4	118	LCAT22-950VLx-R	Rectangle	4187	40.4	104
LCAT22-50VLHE	Curve	4649	34.6	134					

PHOTOMETRIC DATA

Test 16540 Test Date 7/28/2016

LUMINAIRE DATA

Luminaire	LCAT22-35LWG-EU LCAT Led Architectural Troffer, Recessed Architectural 2 x 2 led with frosted linear prism lens
Ballast	XI040C11CV054BST1
Ballast Factor	1.00
Lamp	LED
Fixture Lumens	2769
Watts	22.60
Mounting	Recessed
Shielding Angle	0° = 90 90° = 90
Spacing Criterion	0° = 1.19 90° = 1.31
Luminous Opening in Feet	Length: 1.92 Width: 1.92 Height: 0.00

ZONAL LUMEN SUMMARY

Zone	Lumens	% Lamp	% Fixt.
0-30	705	25.5	25.5
0-40	1154	41.7	41.7
0-60	2056	74.3	74.3
0-90	2769	100.0	100.0
0-180	2769	100.0	100.0

ENERGY DATA

Total Luminaire Efficiency	100.0%
Total Lumens per Watt	123
IESNA RP-1-2004 Compliance	Non-Compliant
Comparative Yearly Lighting Energy Cost per 1000 Lumens	\$2.00 based on 3000 hrs. and \$0.08 per KWH

INDOOR CANDELA PLOT

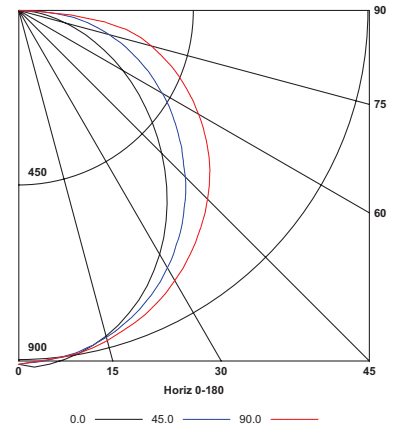

LUMINAIRE DATA

Luminaire	LCAT22-35MLG-EU LCAT Led Architectural Troffer, Recessed Architectural 2 x 2 led with frosted linear prism lens
Ballast	XI040C11CV054BST1
Ballast Factor	1.00
Lamp	LED
Fixture Lumens	3420
Watts	28.70
Mounting	Recessed
Shielding Angle	0° = 90 90° = 90
Spacing Criterion	0° = 1.19 90° = 1.31
Luminous Opening in Feet	Length: 1.92 Width: 1.92 Height: 0.00

ZONAL LUMEN SUMMARY

Zone	Lumens	% Lamp	% Fixt.
0-30	871	25.5	25.5
0-40	1424	41.7	41.7
0-60	2539	74.2	74.2
0-90	3420	100.0	100.0
0-180	3420	100.0	100.0

ENERGY DATA

Total Luminaire Efficiency	100.0%
Total Lumens per Watt	119
IESNA RP-1-2004 Compliance	Non-Compliant
Comparative Yearly Lighting Energy Cost per 1000 Lumens	\$2.03 based on 3000 hrs. and \$0.08 per KWH

INDOOR CANDELA PLOT

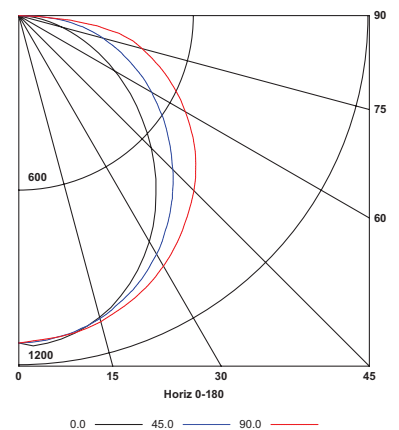

Test 16543 Test Date 7/28/2016

LUMINAIRE DATA

Luminaire	LCAT22-35HLG-EU LCAT Led Architectural Troffer, Recessed Architectural 2 x 2 led with frosted linear prism lens
Ballast	XI040C11CV054BST1
Ballast Factor	1.00
Lamp	LED
Fixture Lumens	3707
Watts	31.80
Mounting	Recessed
Shielding Angle	0° = 90 90° = 90
Spacing Criterion	0° = 1.19 90° = 1.31
Luminous Opening in Feet	Length: 1.92 Width: 1.92 Height: 0.00

ZONAL LUMEN SUMMARY

Zone	Lumens	% Lamp	% Fixt.
0-30	943	25.4	25.4
0-40	1543	41.6	41.6
0-60	2751	74.2	74.2
0-90	3707	100.0	100.0
0-180	3707	100.0	100.0

ENERGY DATA

Total Luminaire Efficiency	100.0%
Total Lumens per Watt	117
ANSI/IESNA RP-1-2004 COMPLIANCE:	Non-Compliant
Comparative Yearly Lighting Energy Cost per 1000 Lumens	\$2.07 based on 3000 hrs. and \$0.08 per KWH

INDOOR CANDELA PLOT

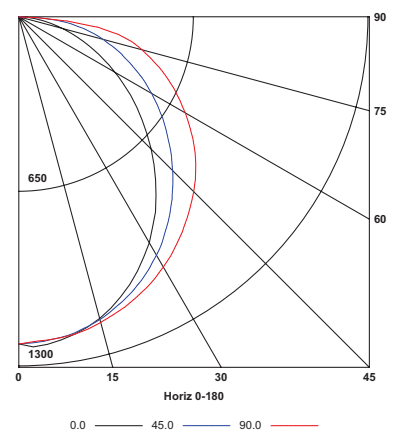

Test 16546 Test Date 7/28/2016

DIMENSIONAL DATA — GRID, STATIC

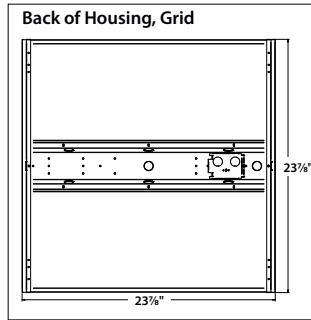
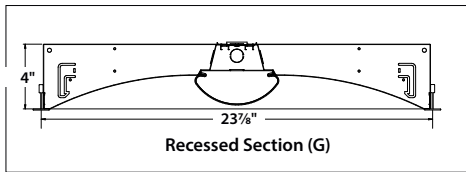

CEILING COMPATIBILITY

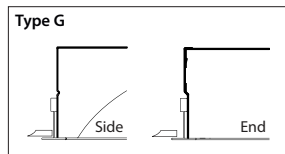

For lay-in installation in exposed grid ceilings. Maximum tee widths of 1" and maximum tee heights of 2" allowed.

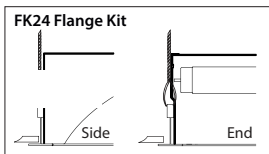

For hard ceiling applications, order FK22 flange kit. Flange kit wires directly into concealed ceiling opening for a clean, finished appearance.

GRID, STATIC

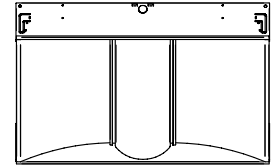
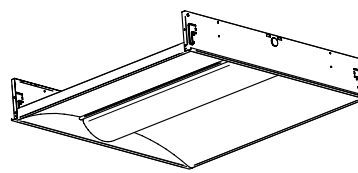

GRID, AIR RETURN

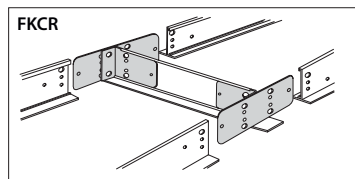
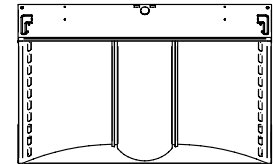
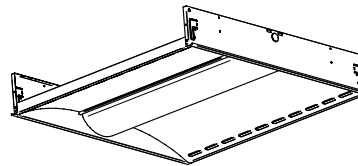

For flanged fixtures in row configurations, the FKCR adapter bracket kit is required in addition to the FK22 kit. Order one less FKCR than the total number of fixtures in row. (Example: Row of two, order (2) FK22 & (1) FKCR)

Row cut out dimensions using FK22s & FKCR adapters:
Width 24 3/8", Length [24" x (# in row)] + 3/8".
Example: (24" x 2) + 3/8" = 48 3/8"

Flange kit cut out dimension for single unit only: 24 3/8" x 24 3/8"

DIMENSIONAL DATA — SURFACE MOUNT & CABLE MOUNT, STATIC ONLY

Surface Section (SM)

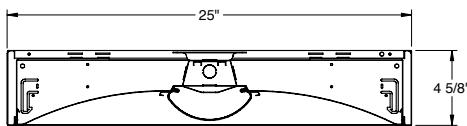

Back of Housing, Surface Mount (SM) and Cable Mount (CM)

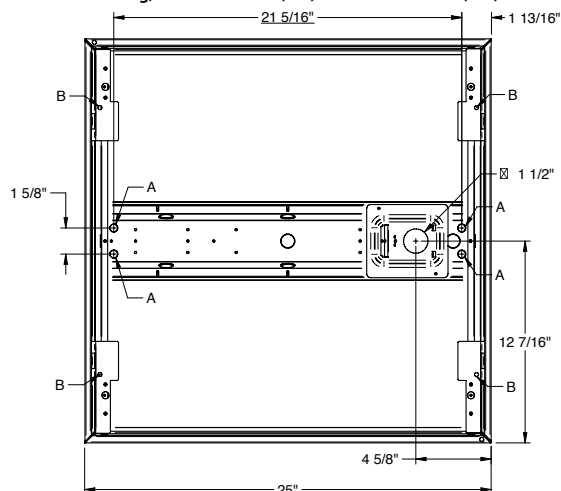

Surface Mount:

Order SM ceiling type. Mounting collar required for surface mounting. (4) Mounting knock-outs, 3/8", provided in center channel as indicated at left, marked A.

Cable Mount:

Order CM ceiling type. Use CM48Y2SC3F-KIT 48" Cable Mount Kit for 2' wide CM fixtures. Mounting holes are provided in diagonal straps shown at left, marked B.

* For Cable Mount a 2" x 3" access plate with (4) 7/8" KOs provided in place of Mounting Collar shown.

NOTE: All dimensions are in inches; dimensions and specifications are subject to change without notice. Please consult factory or check sample for verification.