

# LDT-05

## Digital electronic theodolite

### *User Manual*





# Content

1. Use and Scope of Application of the instrument
2. Main Technical Parameters
3. Structure
4. Function of Buttons
5. Preparation before Measurement
  - 5.1 Preparation of Battery
  - 5.2 Set-up of the Instrument
  - 5.3 Leveling of the Instrument
  - 5.4 Centering
  - 5.5 Collimation
  - 5.6 Initial Setting
6. Operation Method
  - 6.1 Start Up
  - 6.2 Measurement of Angles
  - 6.3 Turning Off
  - 6.4 Measuring Distance Using the Stadia Method
  - 6.5 Installation and Removal of Base
7. Inspection and Adjustment
  - 7.1 Tubular vial
  - 7.2 Circular vial
  - 7.3 Laser Plummet
  - 7.4 Perpendicularity of Vertical Hair of Reticle of Telescope
  - 7.5 Collimation error
  - 7.6 Index Error of Vertical Circle
8. Accessories
9. Error Information

## Cautions

- Carefully read and understand this manual before use.
- Do not directly aim the telescope to the sun to avoid injury to your eyes.
- Do not loosen or remove any screw(s) of the instrument.
- Protect the instrument from hard shocks.
- Do not carry the instrument mounted on a tripod on your shoulder.
- Do not expose the instrument under the sun for long periods of time and keep away from heat source to avoid damage.
- Sudden changes of temperature will influence the precision of measurement and the normal operation of the electronic system and may cause fogging on the object lens. When the instrument is taken from the cold weather outdoors to indoors, it must be placed in a warm place to allow any fog to evaporate.
- This instrument contains many sensitive electronic components and is provided with protection against dust and moisture. If dust or moisture enters into the instrument damage to the instrument may result. Therefore, after using in a humid environment, the instrument must be dried immediately and stored in the instrument case.
- The display of LCD system will be affected in operation under low temperatures. It is recommended to start the instrument in advance before operation.
- The battery must be removed from the instrument if it is to be out of service for a long time.
- Before placing the instrument into the instrument case, align the dot mark of the instrument up ward and on the same line, and lightly tighten the clamp knobs then loosen after the instrument is placed in the case. All the clamp knobs must be slightly tightened again after the instrument is in place in the case for transport.



## 1. Use and Scope of Application of the Instrument

This series of electronic theodolite adopts the photoelectric incremental angle measuring system. They integrate optical, mechanical, electronic and computer technologies all in one, realizing a variety of functions including angle measurement, display and storage. They can also display horizontal and vertical angles and realize conversion from vertical angle to gradient and compensation of vertical angle. The precision of angle measurement is 5".

This series of electronic theodolite adapts to wide applications in the Grade III and Grade IV triangle control measurement in national and urban projects, including engineering measurement in railway, highway, bridge, water conservancy, mining projects, etc. It can be also used in various engineering, construction, and topographic surveys.

## 2. Main Technical Parameters

Telescope	Image	Erect
	Magnification	30x
	Objective aperture	45mm
	Field of view	1°30'
	Shortest visibility distance	1.35m
	Stadia multiplying constant	100
	Stadia additive constant	0
	Resolution	3"
Angle Measurement System	Mode of angle measurement	Photoelectric incremental reading
	Minimum reading	1" 5"
	Detection method	H: both sides; V: single side
	Precision of angle measurement	5"
	Angle unit	DEG MIL GON
	Display	LCD double sides
Compensator	Tilt sensor	Yes - vertical
	Compensator range	± 3'
Optical Plummet	Image	Erect
	Magnification ratio	3x
	Angle of View	5°
	Focusing range	0.5m~ ∞
Vial sensitivity	Tubular vial	30" /2mm
	Circular vial	8' /2mm
Ambient temperature range		-20°C ~ +50°C
Power	Battery	Alkaline battery, rechargeable Ni-H battery
	Source voltage	4.8V
	Duration of operation	Alkaline battery 36h
Weight		4.6kg
Dimensions		164 x 154 x 340mm

### 3. Structure



### 3. Structure (part 2)

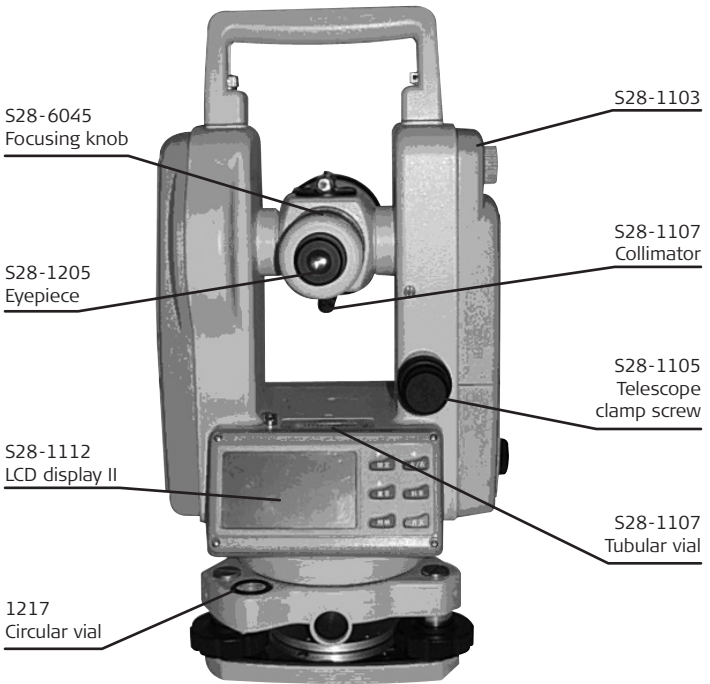



## 4. Function of Buttons

Button	Function 1	Other
ON/OFF	ON/OFF power for the instrument	<ol style="list-style-type: none"> <li>1. One of the functions for entering into initial setting of the instrument.</li> <li>2. One of the function buttons for entering into index error setting.</li> <li>3. One of the function buttons for entering into compensation setting.</li> </ol>
	Button for illumination of Reticle and LCD Display	
OSET △	Reset of horizontal angle (zeroing)	<ol style="list-style-type: none"> <li>1. Menu selection button in initial setting.</li> <li>2. One of the function buttons for entering into Compensator setting.</li> <li>3. One of the function buttons for entering into initial setting of the instrument.</li> </ol>
HOLD ▷	Horizontal angle hold button	<ol style="list-style-type: none"> <li>1. Menu selection button in initial setting.</li> <li>2. One of the function buttons for entering into initial setting of the instrument.</li> <li>3. One of the function buttons for entering into index error setting.</li> </ol>
R/L ◁	Increment of left rotation and right rotation of horizontal angle	<ol style="list-style-type: none"> <li>1. Menu selection button in initial setting.</li> <li>2. One of the function buttons for entering into initial setting of the instrument.</li> </ol>
V%	Vertical angle and slope convert	<ol style="list-style-type: none"> <li>1. One of the function buttons for entering into initial setting of the instrument.</li> <li>2. Button for confirmation after initial setting of the instrument.</li> </ol>

## 5. Preparation before Measurement

### 5.1 Preparation of Battery

5.1.1 Checking the Electric Quantity of Battery Case Refer to 6.1.3

5.1.2 Removal of Battery Case

1. Turn the knob of the battery case and let the mark ▼ point to "UNLOCK", take the battery case off. (as shown in Fig.5-1).
2. Open the case cover, insert four AA batteries into the battery case according to (+) and (-).
3. Insert the raised part at the bottom of the battery case into the slot of the right battery cover, and put the battery case in place. Then turn the knob and let the mark ▼ point to "LOCK" (as shown in Fig. 5-2).



Fig 5-1



Fig 5-2

## 5. Preparation before Measurement

### 5.1.3 Recharging the Battery

1. Remove the charger from the instrument case and connect the charger to AC 110V power source. The green light on the charger is lit.
2. Insert the charger plug into the charging port of the battery case. The green light of the charger turns red, the charging process is started. After 3–4 hours when the red light turns green, it indicates that the charging process is complete.

#### ATTENTION

- The four batteries in the battery case should be of the same brand-type.
- Do not use batteries which have different remaining capacities.
- When batteries are wet, dry them immediately, and take them out of the instrument case, air-dry thoroughly.
- When the battery case is removed from the unit, power must be off to avoid damage or problems.

## 5. Preparation before Measurement

### 5.2 Set-up of the Instrument

- 5.2.1 Extend the tripod to the desired height .
- 5.2.2 Ensure that the measure point is exactly under the central hole of the tripod head.
- 5.2.3 Level up the tripod (this is very important when centering with plumb bob).
- 5.2.4 Ensure that all locking handles are securely tightened.
- 5.2.5 Secure the instrument to the tripod.

### 5.3 Leveling up of the Instrument

- 5.3.1 Centering the circle vial using leveling screws A, B and C. (Presume that the three leveling screws be A, B and C).
- 5.3.2 Turn the collimation unit so that the axis of the tubular vial is parallel to the connecting line of B and C. adjust B and C so that the tubular vial is centered (as shown in 1. of Fig. 5-3).
- 5.3.3 Turn the collimation  $90^\circ$ , adjust the leveling screw A and center the bubble.
- 5.3.4 Repeat 5.3.2–5.3.3, until the bubble is the centered when observed from both directions.

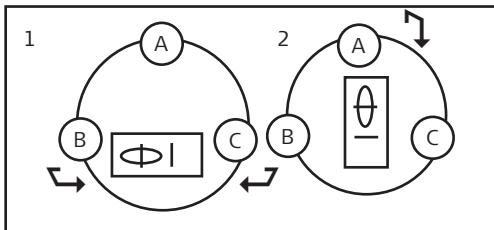

Fig 5-3

## 5. Preparation before Measurement

- 5.3.5 After 5.3.2 is complete, turn collimation unit  $180^\circ$ . If the tubular vial is still centered, the leveling up of the instrument is complete. If the bubble strays from the center, perform leveling up with the procedure for adjustment of tubular vial in "Inspection and Adjustment".

### 5.4 Centering

#### 5.4.1 Centering with Plumb Bob

1. Tie the plumb bob wire to the hook on the central screw. Adjust the length of the wire so that the tip of the bob is (1/8") 2mm above ground.
2. Loosen the central screw and move the base so that the tip of the plumb bob is precisely positioned to the ground point (when observed from two directions perpendicular to each other).

#### 5.4.2 Centering with Laser plummet

To ensure maximum measuring precision, we recommend the performance of the steps described in "Inspection and Adjustment" before using this instrument.

1. View the laser beam in relation to the desired target point. Loosen the central screw to translate the whole instrument (be sure not to turn the instrument) so that the ground point coincides with the central point of the laser. Retighten the central screw.
2. Perform precise leveling up of the instrument as described in 5.3 and repeat the operation in (1) of 5.4.2 until the instrument is precisely leveled up and the center of the laser precisely coincides with the ground point (as shown in Fig.5-4).

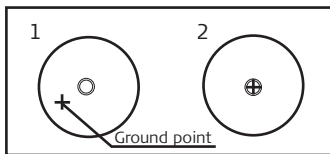

Fig. 5-4

## 5. Preparation before Measurement

### 5.5 Collimation

#### 5.5.1 Adjustment of diopter

Direct the telescope to a bright background. Turn the eyepiece knob so that the cross hairs of the reticle are clearly seen.

#### 5.5.2 Elimination of Optical Parallax

Adjust the focusing knob so that the object forms an image on the reticle. Move your eyes up and down to see if the image of the object moves relative to the graduation lines. If it does not move, there is no optical parallax; otherwise turn the focusing knob to eliminate the optical parallax.

### 5.6 Initial Settings

Before you start measuring, please confirm all initial settings. Items in bold indicate factory settings.

Initial Setting	Selection		
1. Unit of Angle	<b>360°</b> <b>UNIT A</b>	400G UNIT B	6400 UNIT C
2. Zenith Angle	<b>ZEN = = 0</b>	ZEN = = 90	
3. Auto Power Off Time	<b>30 OFF</b>	NO OFF	
4. Min. Display	<b>DSP1</b>	DSP5	
5. Compensator Switch	<b>V TILT ON</b>	V T1LT OFF	
6. Indication of Position of Horizontal Angle	<b>NO BEEP</b>	90 BEEP	

#### 5.6.1 Method of Setting

Press and hold [HOLD] button + [OSET] button and press [ON/OFF] button. Release [ON/OFF] button when full character display appears and release [HOLD] + [OSET] buttons when four beeps are heard. The instrument enters into initial setting mode and the LCD displays:

## 5. Preparation before Measurement

V 360° ' ''  
UNITA ...

1. Press [▷] button or [◁] button for turning pages and selecting options.
2. Press [△] button for selecting specific content in the options.
3. Finally, press [V / %] button to confirm and enter into angle measuring mode.

### 5.6.2 Setting of Items

#### 1. Unit of Angle

UNIT A: 360° (Degree)

UNIT B: 400 (GON)

UNIT C: 6400 (Mil)

#### 2. Zero Position of Vertical Angle

ZEN = = 0: Zenith being 0°

ZEN = = 90: Zenith being 90°

#### 3. Auto Power off Time

NO OFF: Auto power off disabled

30 OFF: Turns power off if no action within 30min

#### 4. Minimum Display

DSP 1: minimum display being 1"

DSP 5: minimum display being 5"

DSP 10: minimum display being 10"

V 360° ' ''  
UNITA ...



ZEN==90  
VERTICAL ...



NO OFF  
AUTO OFF ...



DSP 1 ...

## 5. Preparation before Measurement

### 5. Setting of compensator

V TILT ON: Turn on the compensator

V TILT OFF: Turn off the compensator



### 6. Indication of Horizontal Angle

NO BEEP: Horizontal angle indication disabled

90 BEEP: Beeps when the instrument is close to  $0^\circ$ ,  $90^\circ$ ,  $180^\circ$  and  $270^\circ$ .





## 6. Operation Method

### 6.1 Start Up

- 6.1.1 Press and hold [ON/OFF] button. Release [ON/OFF] button when the full character display appears. The LCD displays:

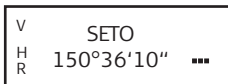

- 6.1.2 Sway the telescope up and down ward when the instrument is in the normal position. A beep occurs and the LCD displays vertical angle. The instrument enters into measuring mode.
- 6.1.3 After the power is switched on and the instrument has entered into measuring mode, the battery energy consumption is indicated by the battery symbol in the lower right corner of LCD.
1. If all of the three cubes are displayed, it indicates that the battery is fully
  2. Decreasing of the cubes indicates the reduction of charge.
  3. If the battery symbol twinkles, it indicates a low battery and recharging is required.

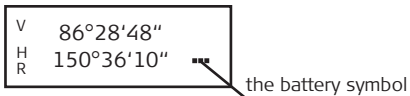

### 6.2 Measurement of Angles

- Observing in the "Normal" and "Reverse" Positions of the Telescope

The normal position of the telescope refers to observation with the object lens facing right ahead (the vertical encoder being on the left); the reverse position refers to observation with the object lens facing right ahead (the vertical encoder being on the right). The mechanical errors can be offset by the average of the values of measured in the normal and reverse positions.

## 6. Operation Method

### 6.2.1 Measurement of Vertical Angle

#### 1. Measurement of $0^\circ$ angle of vertical angle

$0^\circ$  angle position can be set as follows in the initial setting:

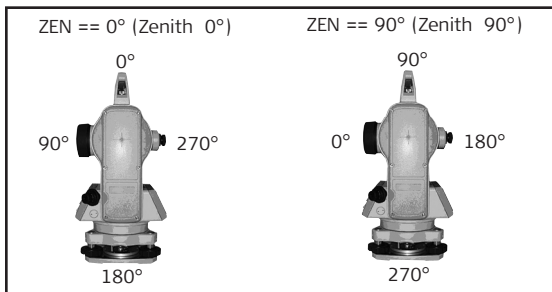

Fig. 6-2

#### 2. Compensation of the tilt sensor to Vertical Angle

If the instrument is inclined within  $\pm 3'$ , the tilt sensor compensates to the vertical angle.

If the inclination is greater than  $\pm 3'$ , the instrument will display as shown in the figure.

#### 3. Display of slope

Press [V/%] button, the vertical angle display is turned into a slope display; press [V/%] button, the vertical angle display is resumed.

Note: When vertical angle is turned into slope, the precision of slope is to the fourth digit after the decimal.

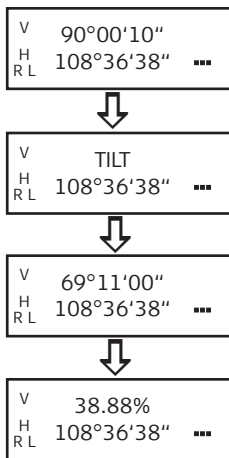

## 6. Operation Method

The value of slope is effective within  $\pm 45^\circ$ ; there will be no slope display exceeding this range.



V	69°11'00"	
H	150°36'10"	...
R L		

### 6.2.2 Measurement of Horizontal Angle

#### 1. Reset of Horizontal Angle

Press [OSET] button, the horizontal angle returns to zero.

V	90°00'10"	
H	150°36'10"	...
R L		



V	90°00'10"	
H	00°00'00"	...
R L		

#### 2. Selecting the Direction of Measurement of Horizontal Angle

Press [R/L] button to change the direction of measurement of the horizontal angle.

When "HR" is displayed, the angle increases with clockwise turning of the collimation unit.

When "HL" is displayed, the angle increases with counter-clockwise turning of the collimation unit.

V	90°00'10"	
H	150°36'10"	...
R L		



V	90°00'10"	
H	199°23'50"	...
R L		

## 6. Operation Method

### 3. Holding Horizontal Angle

Press [HOLD] button, the horizontal angle will be held; the reading of the horizontal angle will remain unchanged even if the direction of collimation is changed. Press [HOLD] button again, the hold of horizontal angle is released.

V	90°00'10"	
H	150°36'10"	...
R L		



V	90°00'10"	
H	150°36'10"	...
R L		

### 6.3 Turning Off

Press [ON/OFF] button, "OFF" will be displayed at the position of vertical angle display after a beep; release [ON/OFF] button, the instrument is turned off.

V	OFF	
H	150°36'10"	...
R L		

### 6.4 Measuring Distance Using the Stadia Method

Take reading  $l$  from the staff gauge using the stadia hair on the reticle of the telescope. Multiply reading  $l$  by 100, we obtain the actual distance  $L$  from the target to the measured point. (100 is the multiplication constant error of the instrument, i.e.,  $L = 1 \times 100$ )

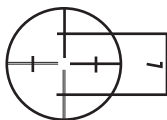

Fig. 6-3

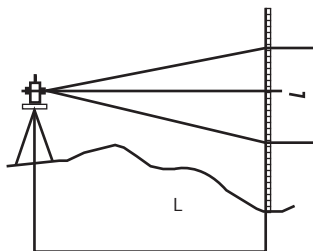

Fig. 6-4

## 6. Operation Method

### 6.5 Installation and Removal of the Base

#### 6.5.1 Remove of the Base

1. Turn the screw on knob S5-3004 outward using flat screw driver until it no more limits position.
2. Turn knob S5-3004 180° counter-clockwise, holding the base with one hand and take the main body of the instrument off the base (as shown in Fig.6-5).

#### 6.5.2 Installation of the Base

1. Turn the knob S5-3004 counter-clockwise until it reaches the position limit ' '. Make the positioning block S3-4001 on the main body of the instrument is in line with the notch on the base and install the main body onto the base (as shown in Fig.6-6).
2. Turn the knob S5-3004 clockwise until it reaches the position limit so that the  $\Delta$  mark points downward. Turn the screw until it can limit position.

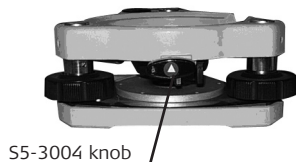

Fig. 6-5

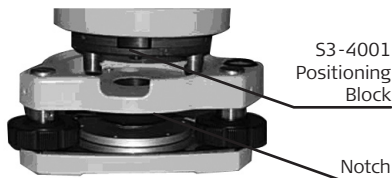

Fig. 6-6

## 7. Inspection and Adjustment

### 7.1 Tubular vial

#### 7.1.1 Inspection

1. Fix the instrument to the tripod and roughly level up the instrument and make the tubular vial parallel to the connecting line of two of the three leveling screws on the base. Adjust the two leveling screws so that the tubular vial is centered.
2. Turn the instrument  $180^\circ$  and check if the bubble remains centered.
3. If the bubble remains centered, no adjustment is required; otherwise, perform adjustment as follows.

#### 7.1.2 Adjustment

1. Adjust the bubble adjusting screw so that the bubble moves toward tube center for half the off-center value (as shown in Fig.7-1)



Fig. 7-1

2. Turn the leveling screw to correct the other half off-center so that the bubble stays centered.
3. Repeat steps in 7.1.1 and 7.1.2 until the long level is centered when the instrument is at any position.

## 7. Inspection and Adjustment

### 7.2 Circle vial

After making sure that the long level is correctly adjusted, check if there is any off-center with the round level. If it is centered, no adjustment is required; otherwise, adjust the three adjustment screws with needle as shown in Fig.7-2 to center the bubble.

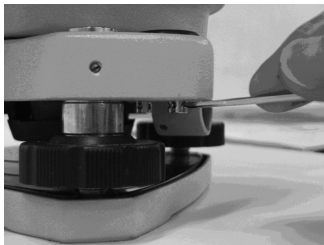

Fig. 7-2

### 7.3 Optical Plummet – **Not applicable to LDT-05 units with laser plummet**

#### 7.3.1 Inspection

1. Set the instrument on the tripod (no adjustment is required).
2. Place the cross mark exactly under the instrument.
3. Adjust the image of the object so that is in focus. Using the optical plummet, adjust the leveling screws so that the cross mark moves to the center of the reticle.
4. Turn the instrument for 180°.
5. If the cross mark remains at the center of the reticle, no adjustment is required; otherwise, adjust as follows.

## 7. Inspection and Adjustment

### 7.3.2 Adjustment

Adjust the adjustment screw of the reticle, using the needle, so that the cross mark moves to halfway of the off-center (as shown in Fig.7-3 and Fig.7-4).

Repeat the steps 3-5 in 7.3.1 and step 1 in 7.3.2 until the cross mark coincides with the center.

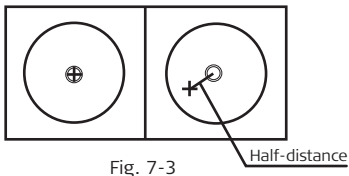

Fig. 7-3

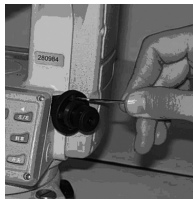

Fig. 7-4

### 7.4 Perpendicularity of Vertical Hair of Reticle of Telescope

#### 7.4.1 Inspection

1. Fix the instrument on the tripod and perform precise leveling up.
2. Set an target point A 50m away from instrument.

Aim the telescope at target point A and adjust the vertical fine movement. If point A moves along the vertical hair of the reticle, no adjustment is required; perform adjustment if the target point A strays from the vertical hair.

#### 7.4.2 Adjustment

1. Remove the protective cover of the reticle and slightly loosen the four adjusting screws. Turn the assembly so that point A coincides with the vertical hair. Retighten the four adjusting screws.

Repeat step 3 in 7.4.1 and step 1 in 7.4.2 until there is no error.



## 7. Inspection and Adjustment



Fig. 7-5

### 7.5 Collimation Discrepancy

#### 7.5.1 Inspection

1. Fix the instrument on the tripod and perform precise leveling up.
2. Aim at object point A in the distance with the normal position of telescope and take the reading of the horizontal angle  $HR_{norm}$ . and aim at object A with the reverse position of the telescope and take the reading of the horizontal angle  $HR_{rev}$  then:

$$\text{Collimation Error } C = (HR_{norm} - HR_{rev} \pm 180^\circ) / 2$$

If  $C < 10''$ , no adjustment is required; if  $C > 10''$ , adjustment is required.

#### 7.5.2 Adjustment

1. Adjust the horizontal fine motion in the reverse position of the telescope so that the reverse reading  $HR_{rev}' = HR_{rev} + C$ .
2. Remove the protective cover of the reticle of the telescope and adjust both the left and right adjusting screws so that the vertical hair of the reticle coincides with object A.

Repeat the steps in 7.5.1 and 7.5.2 until acceptable condition is reached.

## 7. Inspection and Adjustment

### 7.6 Index Error of Vertical Circle

#### 7.6.1 Inspection

1. Fix the instrument on the tripod and perform precise leveling up.
2. Aim the telescope at any object point P in the normal position and take the reading of vertical angle  $V_{norm}$ .
3. Turn the telescope to the reverse position and aim it at point P again. Take the reading of other vertical angle  $V_{Rev}$ .

If  $(V_{norm} + V_{Rev}) - 360^\circ = 2I$ ,  $I \leq 15''$ , no adjustment is required; otherwise, perform adjustment as follows:

#### 7.6.2 Adjustment

1. Press and hold [R/L] + [HOLD] buttons and press [ON/OFF] button. Release [ON/OFF] button when full character display appears and release [R/L] + [HOLD] buttons when four beeps are heard.

V	SETO	...
H	FACE-1	...
R		



2. Sway the telescope near horizontal plane with instrument in the normal position and allow vertical angle to be reset after zero cross.

V	96°28'48"	...
H	FACE-1	...
R		



Aim the telescope in the normal position at object P and press [OSET] to confirm.

V	272°36'06"	...
H	FACE-2	...
R		



Aim the telescope in the reverse position at object P and press [OSET] to confirm. With this, the compensation of index error is completed.

V	90°00'10"	...
H	150°36'10"	...
R		

## 8. Accessories

- 1 x plumb bob
- 1 x tool kit (containing a screw driver and 2 needles)
- 2 x bags of desiccant
- 1 x rain cover
- 1 x instruction manual
- 1 x charger
- 1 x battery case

## 9. Error Information

display	meaning and dealing method
E01	count error, if displayed repetitively ,repair is needed
TOO FAST	the telescope or collimation unit rotated too fast,press any key except [on/off] and [  , the instrument returns to normal state
E04	horizontal sensor I error, repair is needed
E05	horizontal sensor II error, repair is needed
E06	vertical sensor error, repair is needed
TILT	the tilt sensor is out of range, level the instrument again, if in vain, repair is needed. Note: Turn off the tilt sensor, and the instrument still functions

Due to our policy of continuous improvement, we reserve the right to alter product design and specification without prior notification.

Illustrations, descriptions and technical specifications are not binding and may change.  
Printed in USA. SAP# 8227238.