

**INSTRUCTION MANUAL FOR
MAX PERFORMANCE SURFACE LINEAR: 2', 4', 8'**

Components shown in images are representative only and may vary based on the configuration ordered.

Refer to the following sections for instructions on the desired mounting condition:

- A. Surface Mount
- B. Injection Molded ABS Endcap Installation



CAUTION! – READ THIS FIRST - IMPORTANT SAFETY INSTRUCTIONS

WARNING: THIS PRODUCT MUST BE INSTALLED IN COMPLIANCE WITH THE NATIONAL ELECTRICAL CODE AND/OR ANY LOCAL CODES BY A PERSON FAMILIAR WITH THE CONSTRUCTION AND OPERATION OF THE PRODUCT AND THE HAZARDS INVOLVED. IF YOU HAVE ANY QUESTIONS REGARDING THE PROPER INSTALLATION OR LOCAL CODES, CONSULT A QUALIFIED ELECTRICIAN.

WARNING: RISK OF FIRE, MINIMUM OF 90°C SUPPLY CONDUCTOR. CONSULT A QUALIFIED ELECTRICIAN TO ENSURE CORRECT BRANCH CIRCUIT CONDUCTOR.

WARNING: TO AVOID SHOCK HAZARD, DISCONNECT THE POWER AT THE PANEL BOARD (CIRCUIT BREAKER BOX) BEFORE BEGINNING INSTALLATION.

WARNING: INSTALL THE FIXTURE IN ONLY AN INDOOR ENVIRONMENT AND FOR THE INTENDED USE.

WARNING: INJURY TO PERSONS AND DAMAGE TO THE FIXTURE AND/OR MOUNTING SURFACE MAY RESULT IF THE FIXTURE IS PULLED FROM THE SURFACE. TO REDUCE THE LIKELIHOOD OF SUCH INJURY OR DAMAGE, MOUNT ONLY ON A SURFACE THAT IS MECHANICALLY SOUND.

PART NOMENCLATURE

Refer to Figure 1 and Figure 2 for identification of the parts referenced in this guide.

- A. Housing
- B. Metal end cap (2)
- C. Reflector plate assembly
- D. Lens

Injection Molded
ABS Endcap

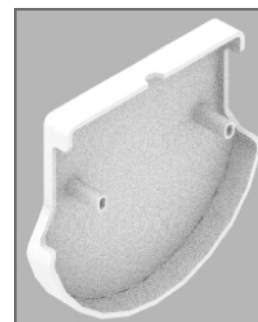
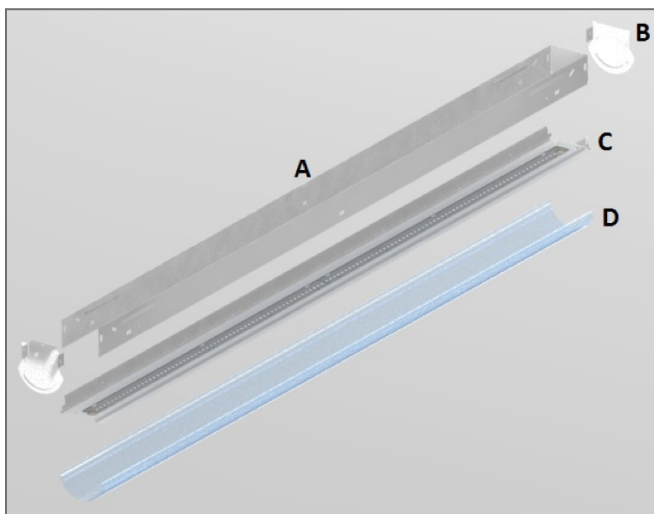

FIGURE 2

FIGURE 1

A. SURFACE MOUNTING INSTRUCTIONS

1. Squeeze the housing above each of the engagement points (circled in red in Figure 3) and separate the reflector plate and lens from the housing.

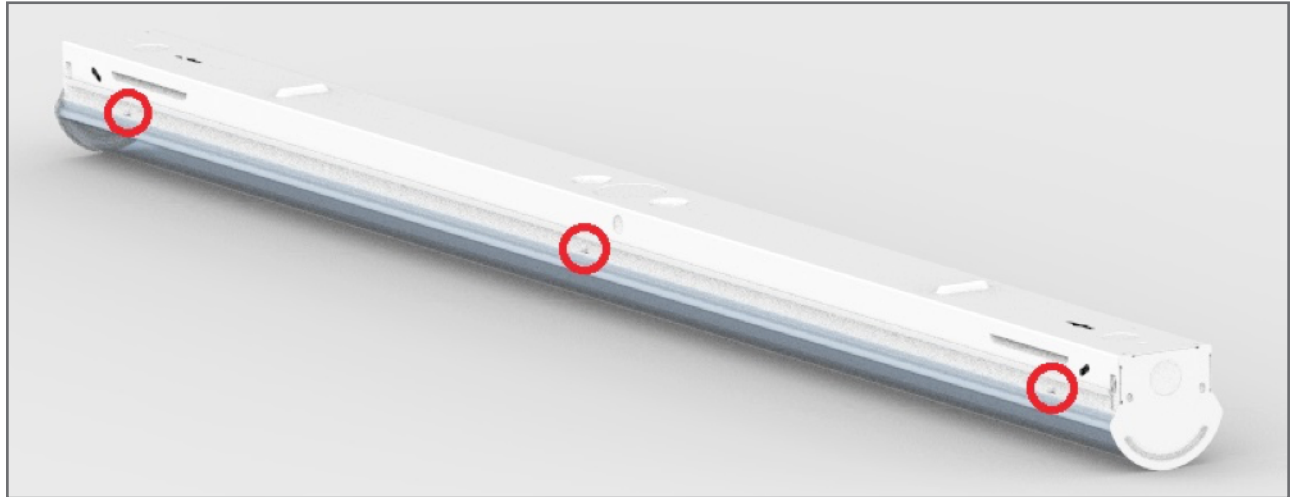

FIGURE 3

2. Select the knockout desired for input wire routing either on the housing or the metal end cap and remove it.

3. Position the housing to the desired mounting location on the wall or ceiling. At the designated mounting points (circled in blue in Figure 4), use appropriate fasteners (by others) to secure the housing to wall or ceiling.

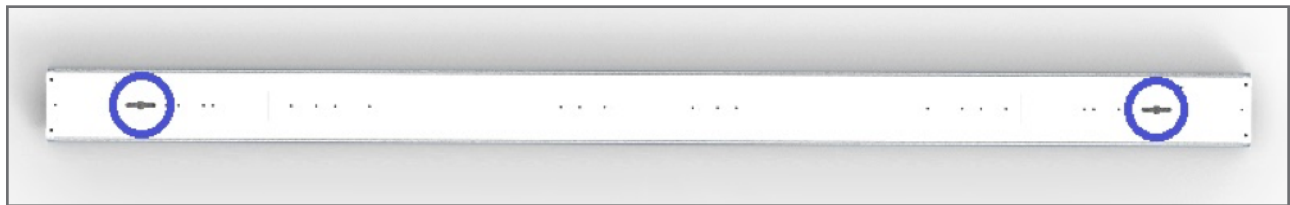

FIGURE 4

5. Route the input wires through the chosen knockout and make electrical connections according to Figure 5.

6. Reinsert the reflector plate and lens. If desired, screws (by others) can be inserted next to the outer engagement points to further secure the reflector plate to the housing.

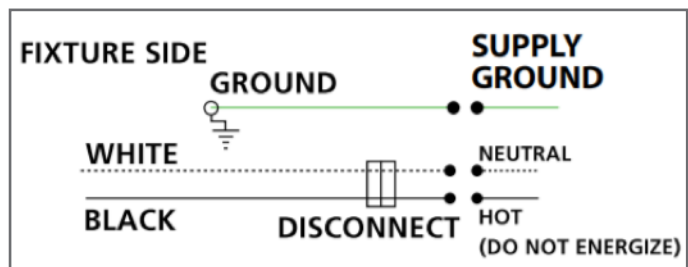

FIGURE 5

B. INJECTION MOLDED ABS ENDCAP INSTALLATION

1. Remove the two oblong knockouts (circled in Figure 6) on the metal end cap.

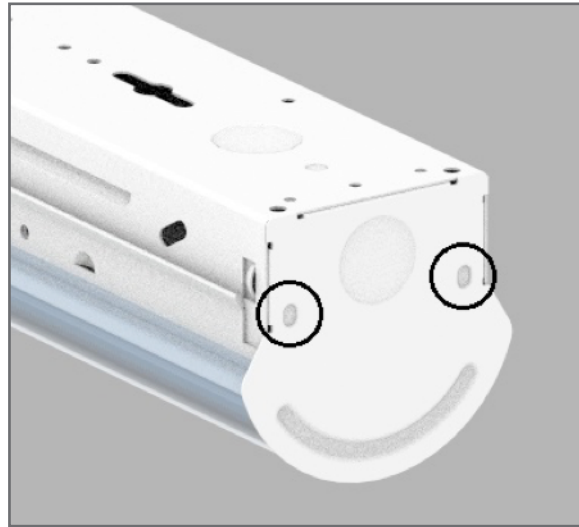

FIGURE 6

2. Snap the Injection Molded ABS Endcap (Figure 2) into place over the metal end caps as shown in Figure 7.

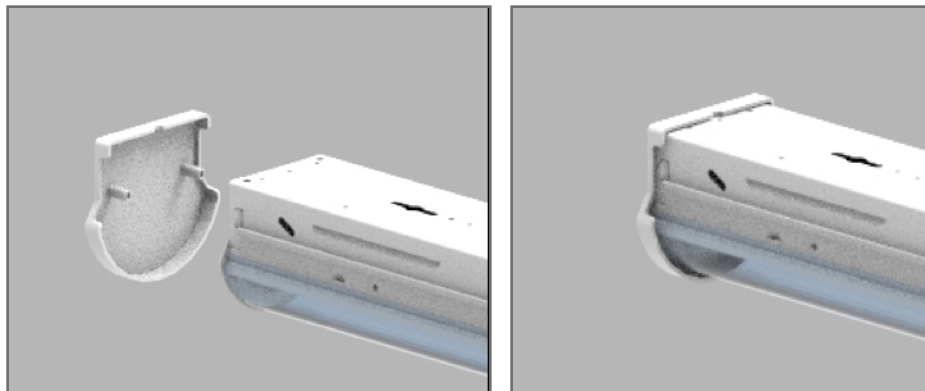

FIGURE 7