

Weather Station models 01021 / 06047



CONTENTS

Unpacking Instructions	2	Backlight Settings	11
Package Contents	2	Placement Guidelines	13
Product Registration	2	Using the Weather Station	15
Features & Benefits: Lightning Sensor ..	3	Programmable Alarms	16
Features & Benefits: Display	4	Troubleshooting	18
Features & Benefits: Rain Gauge ..	7	Care & Maintenance	19
Setup	8	Calibration	20
Lightning Sensor Setup	8	Specifications	22
Rain Gauge Setup	9	FCC Information	22
Display Setup	10	Customer Support	23
Set the Time, Date & Units	11	Warranty	23

Questions? Contact Customer Support at (877) 221-1252 or visit www.AcuRite.com.

SAVE THIS MANUAL FOR FUTURE REFERENCE.



Congratulations on your new AcuRite product. To ensure the best possible product performance, please read this manual in its entirety and retain it for future reference.

Unpacking Instructions

Remove the protective film that is applied to the LCD screen prior to using this product. Locate the tab and peel off to remove.

Package Contents

1. Display with Tabletop Stand
2. Lightning Sensor
3. Rain Gauge
4. Power Adapter
5. Instruction Manual

IMPORTANT

PRODUCT MUST BE REGISTERED
TO RECEIVE WARRANTY SERVICE

PRODUCT REGISTRATION

Register online to receive 1 year warranty protection

www.AcuRite.com

Features & Benefits

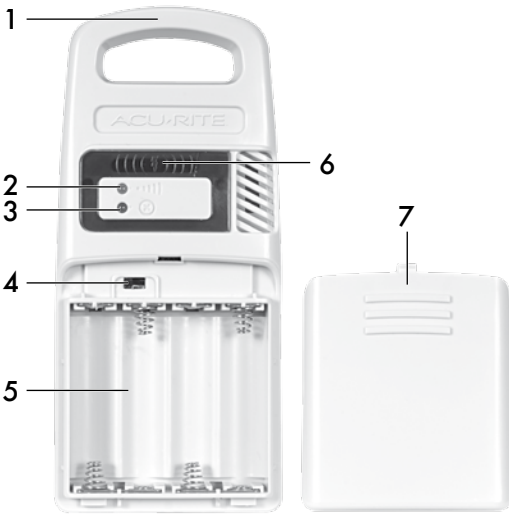

LIGHTNING SENSOR

- 1. Integrated Hanger**
For easy placement.
- 2. Wireless Signal Indicator**
Flashes when data is being sent to the companion unit.
- 3. Interference Indicator**
Flashes when interference is detected (see page 14).
- 4. A-B-C Switch**
ID code that must match display's A-B-C switch to ensure units synchronize.
- 5. Battery Compartment**
- 6. Lightning Strike Indicator**
Indicates a lightning strike has occurred within 25 miles (40 km).
- 7. Battery Compartment Cover**

NOTE: Under no circumstances shall the Lightning Detector, Chaney Instrument Co. or the Primex Family of Companies be held responsible for any damages whatsoever that may result from the use of or inability to use this product, including without limitation any indirect, incidental, special, exemplary or consequential damages, which are expressly disclaimed. This disclaimer of liability applies to any damages or injury caused by any failure of performance, error, omission, inaccuracy, interruption, deletion, defect, delay in operation or transmission software virus, communication failure, theft or destruction or unauthorized access to, alteration of, or use of the product, whether for breach of contract, tortious behavior (including, without limitation, strict liability), negligence, or under any other cause of action, to the fullest extent permissible by law. This does not affect any statutory rights which may not be disclaimed. The contents of this product, including all lightning and weather data are provided "as is" and without warranty or condition of any kind, express or implied, including, without limitation, any warranty of merchantability or fitness for a particular purpose. Chaney Instrument Co. & the Primex Family of Companies do not warrant that this product or the data that it provides will be free of errors, interruptions, viruses or other harmful components. Chaney Instrument Co. & the Primex Family of Companies do not warrant the accuracy or reliability of any lightning strike alerts, weather data or other information provided by the product. Chaney Instrument Co. & the Primex Family of Companies reserve the right to alter the product or withdraw it from the market at its sole discretion.

Features & Benefits

FRONT OF DISPLAY



FRONT OF DISPLAY

1. Current Outdoor Temperature

Arrow indicates direction temperature is trending.

2. Outdoor Low Temperature Record

Lowest temperature recorded since midnight.

3. Outdoor High Temperature Record

Highest temperature recorded since midnight.

4. Current Outdoor Humidity

Arrow indicates direction humidity is trending.

5. Outdoor Low Humidity Record

Lowest humidity recorded since midnight.

6. Outdoor High Humidity Record

Highest humidity recorded since midnight.

7. Seasonal Information

Displays dew point calculation when temperature is 79°F (26°C) or below. Displays heat index calculation when temperature is 80°F (27°C) or above.

8. Interference Indicator

Flashes when interference is detected (see page 14).

9. Strike Counter

Displays most recent total of lightning strikes that has been detected (today, this week, this month).

10. Lightning Strike Indicator

Indicates a lightning strike has occurred within 25 miles.

11. Alarm ON Indicator

Indicates alarm is activated to emit an audible alert when conditions exceed your presets (see page 16).

12. Lightning Sensor Low Battery Indicator

13. Lightning Sensor Signal Strength

14. Rain Gauge Signal Strength

15. Rain Gauge Low Battery Indicator

16. RECORDS Button

Press to view historical records.

17. SELECT and SELECT Buttons

For setup preferences and display navigation.

18. Icon

Indicates display is in auto-dimming brightness mode (see page 11).

19. SET ENTER Button

For setup preferences.

20. Display Low Battery Indicator

21. ALARMS Button

For alarm setup.

22. Date

23. Clock

Automatically updates for Daylight Saving Time.

24. Rainfall

Accumulates data during rainfall.

25. FLOODING POSSIBLE Indicator

Indicates conditions are present that could lead to flooding.

26. Estimated Distance to Storm Front

Updates with latest lightning strike detected today.

27. Current Barometric Pressure

Arrow icon indicates direction pressure is trending.

28. Icon

Disappears after weather forecast self-calibration is complete.

29. 12 to 24 Hour Weather Forecast

Self-Calibrating Forecasting pulls data from the outdoor sensor to generate your personal forecast.

30. Storm Alert Indicator

Activates when barometric pressure drops.

31. Backlight Button

For momentary backlight and dimmer settings.

32. Freeze Alert Indicator

Indicates temperature is below freezing (32°F; 0°C).

Features & Benefits



BACK OF DISPLAY

- 1. Integrated Hang Hole**
For easy wall mounting.
- 2. RESET Button**
Press and release for full reset to factory defaults.
- 3. Plug-in for Power Adapter**
- 4. Power Adapter**
- 5. Battery Compartment Cover**
- 6. Battery Compartment**
- 7. A-B-C Switch**
ID code that must match the lightning sensor and rain gauge's A-B-C switches to ensure units synchronize.

Features & Benefits

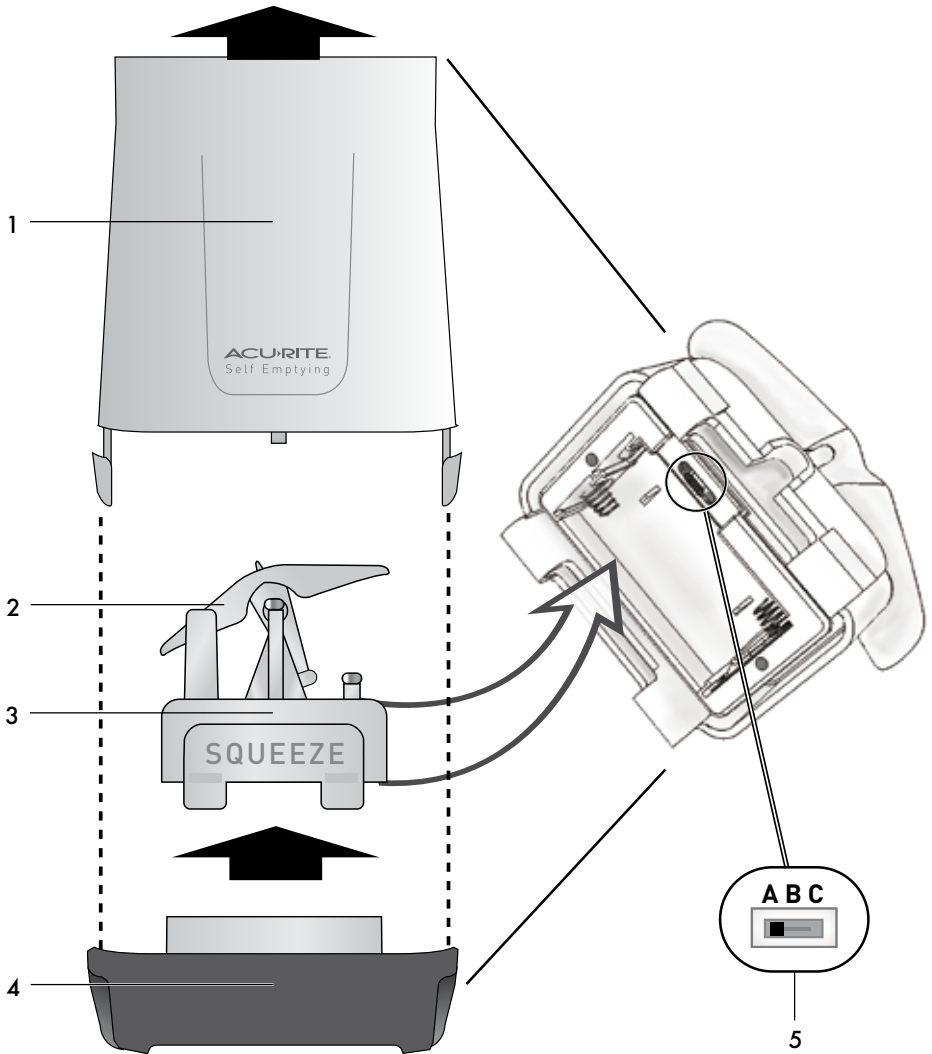

RAIN GAUGE

1. Rain Gauge Cover

2. Rain Gauge Tipping Cups

Collects and empties rain for continuous rain measurement.

3. Battery Compartment & Electronics Box

4. Rain Gauge Base

5. A-B-C Switch

ID code that must match display's A-B-C switch to ensure units synchronize.

Lightning Sensor Setup

1 Set the A-B-C Switch

Locate the A-B-C switch inside the battery compartment. It can be set to A, B or C. However, you must select the same letter choices for the display, rain gauge and lightning sensor in order for the units to synchronize.

The sensor requires lithium batteries in low temperature conditions. Cold temperatures can cause alkaline batteries to function improperly. Use lithium batteries in the sensor for temperatures below -4°F / -20°C.

2 Install or Replace Batteries

AcuRite recommends high quality alkaline or lithium batteries in the wireless sensor for the best product performance. Heavy duty or rechargeable batteries are not recommended.

1. Slide off the battery compartment cover.
2. Insert 4 x AA batteries into the battery compartment, as shown. Follow the polarity (+/-) diagram in the battery compartment.
3. Replace the battery cover.

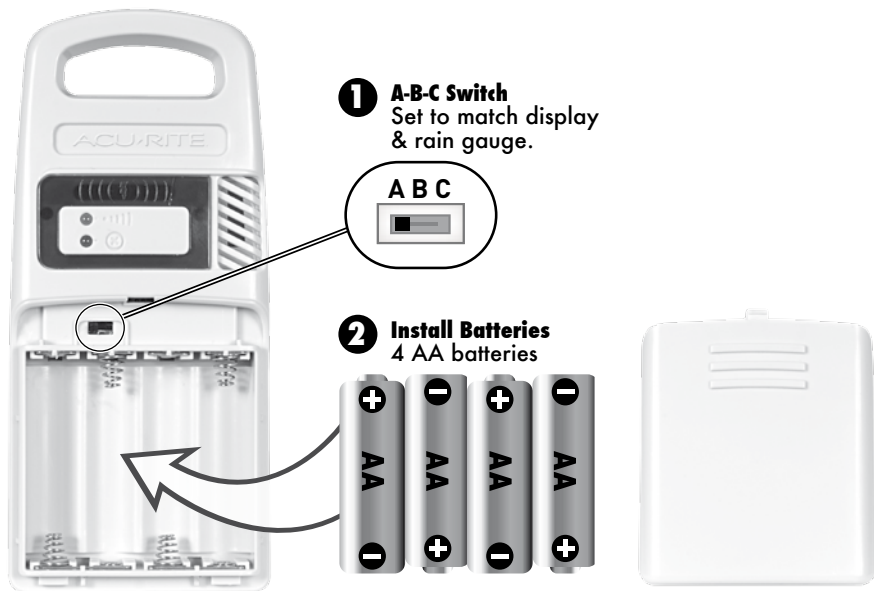

1 A-B-C Switch
Set to match display & rain gauge.

2 Install Batteries
4 AA batteries

LITHIUM BATTERIES **-40°F** (-40°C) (70°C) **158°F**

ALKALINE BATTERIES **-4°F** (-20°C) (70°C) **158°F**





PLEASE DISPOSE OF OLD OR DEFECTIVE BATTERIES IN AN ENVIRONMENTALLY SAFE WAY AND IN ACCORDANCE WITH YOUR LOCAL LAWS AND REGULATIONS.

BATTERY SAFETY: Clean the battery contacts and also those of the device prior to battery installation. Remove batteries from equipment that will not be used for an extended period of time. Follow the polarity (+/-) diagram in the battery compartment. Promptly remove dead batteries from the device. Dispose of used batteries properly. Only batteries of the same or equivalent type as recommended are to be used. DO NOT incinerate used batteries. DO NOT dispose of batteries in fire, as batteries may explode or leak. DO NOT mix old and new batteries or types of batteries (alkaline/standard). DO NOT use rechargeable batteries. DO NOT recharge non-rechargeable batteries. DO NOT short-circuit the supply terminals.

Rain Gauge Setup

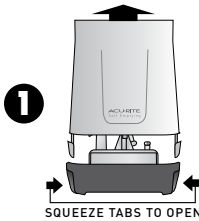
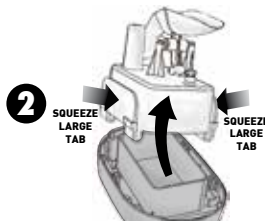
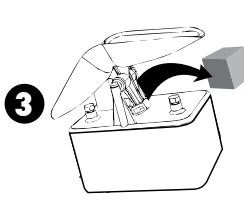
Install or Replace Batteries

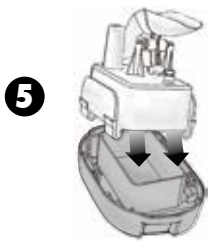
AcuRite recommends high quality alkaline batteries for the best product performance. Heavy duty or rechargeable batteries are not recommended.

- 
- 
- 
- 
- 
- 
1. Separate rain gauge cover from the base by gently squeezing tabs and pulling the cover upwards.
 2. Remove battery box by squeezing the two tabs on each end together (take note of battery box orientation, for re-installation).
 3. Remove and discard cardboard rain gauge stabilizer.
 4. Insert 2 x AA batteries into the battery compartment as shown. Follow the polarity (+/-) diagram in the battery compartment.
 5. Securely place the battery box back into the rain gauge base.
 6. Securely re-attach the rain gauge cover onto rain gauge base.

Set the A-B-C Switch

Locate the A-B-C switch inside the battery compartment. Set the A-B-C switch to A, B or C. You must select the same letter choices for the rain gauge, display and lightning sensor in order for the units to synchronize.

- 
- 1 **A-B-C Switch**
Set to match display and lightning sensor.

Display Setup

1 Set the A-B-C Switch

Locate the A-B-C switch inside the battery compartment. It can be set to A, B or C. However, you must select the same letter choices for the display, rain gauge and lightning sensor in order for the units to synchronize.

2 Install or Replace Backup Batteries (optional)

1. Remove the battery compartment cover.

1 **A-B-C Switch**
Set to match rain gauge and lightning sensor.

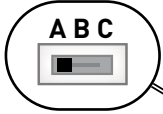

3 **Plug in Power Adapter**

2. Insert 3 x AA alkaline batteries into the battery compartment, as shown. Follow the polarity (+/-) diagram in the battery compartment.

3. Replace the battery cover.

3 Plug in Power Adapter

For the best performance, plug in the power adapter as the main power source for this product.

IMPORTANT: Batteries are a backup power source to preserve records in the event of a power outage. **Power adapter is recommended as the primary power source to enjoy the full functionality of this product.**

2 **Install Backup Batteries (optional)**
3 AA batteries

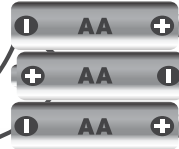



PLEASE DISPOSE OF OLD OR DEFECTIVE BATTERIES IN AN ENVIRONMENTALLY SAFE WAY AND IN ACCORDANCE WITH YOUR LOCAL LAWS AND REGULATIONS.

BATTERY SAFETY: Clean the battery contacts and also those of the device prior to battery installation. Remove batteries from equipment that will not be used for an extended period of time. Follow the polarity (+/-) diagram in the battery compartment. Promptly remove dead batteries from the device. Dispose of used batteries properly. Only batteries of the same or equivalent type as recommended are to be used. DO NOT incinerate used batteries. DO NOT dispose of batteries in fire, as batteries may explode or leak. DO NOT mix old and new batteries or types of batteries (alkaline/standard). DO NOT use rechargeable batteries. DO NOT recharge non-rechargeable batteries. DO NOT short-circuit the supply terminals.

Set the Time, Date & Units

The display will automatically enter SET MODE after the unit has powered on. Once in set mode, the preference you are currently setting will blink on the display.

To adjust the currently selected item, press and release the " " or " " buttons (press and HOLD to fast adjust).

To save your adjustments, press and release the " " button again to adjust the next preference.

The preference set order is as follows:

TIME ZONE (PST MST CST EST AST HAT AKT NAT)

AUTO DST (YES, NO)*

CLOCK HOUR

CLOCK MINUTE

CALENDAR MONTH

CALENDAR DATE

CALENDAR YEAR

TEMPERATURE UNITS (°F or °C)

PRESSURE UNITS (inHg or hPa)

DISTANCE UNITS (mi or km)

RAINFALL UNITS (in. or mm)

* If you live in an area that observes Daylight Saving Time, DST should be set to YES, even if it is not currently Daylight Saving Time.

You will automatically exit SET MODE if no buttons are pressed for 10 seconds. Enter SET MODE at any time by pressing the " " button.

Display Backlight Settings

This weather station's color display features three different lighting settings: High (100%) brightness, Medium (60%) brightness and Low (15%) brightness. Using battery power alone, the backlight is available momentarily for 10 seconds by pressing the backlight button.

When the display is powered with the power adapter, the backlight remains on at 100% brightness. Press the backlight button once to dim to 60% brightness; press again to dim to 15%, press a 3rd time to enter "AUTO DIM" mode.

 appears to the left of the clock to indicate that auto-dim mode is ON.

NOTE: Pressing and holding the backlight button for 5 seconds will disable the backlight. Once any button is pressed, the backlight will return to your selected setting.

AUTO DIM MODE: Automatically adjusts display brightness based on time of day.
6:00 a.m. - 9:00 p.m. = 100% brightness
9:01 p.m. - 5:59 a.m. = 15% brightness

Rain Gauge Installation

- To ensure accurate rain measurement, the rain gauge **MUST** be placed on a flat, level surface.
- Ensure the rain gauge is not placed in a low spot that could become flooded or in an area where there are obstructions above it.

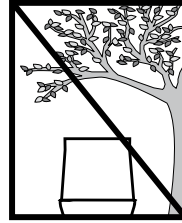
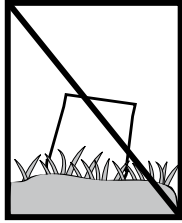
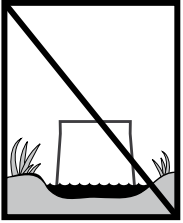

1. Separate the rain gauge cover from the rain gauge base.
2. Locate the two holes on the rain gauge base.
3. Fasten the rain gauge base to a sturdy surface, like a deck railing or a fence post, with screws (included) using hand tools (power tools may slip during installation, causing damage to the rain gauge).

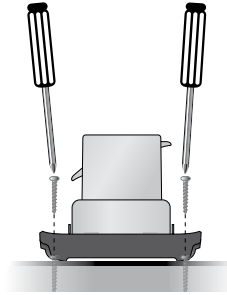
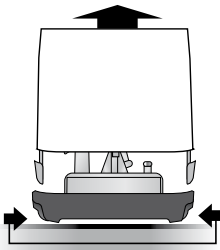

Placement for Maximum Accuracy

AcuRite sensors are sensitive to surrounding environmental conditions. Proper placement of the display, 5-in-1 sensor and lightning sensor is critical to the accuracy and performance of this product.



Display Placement

Place the display in a dry area free of dirt and dust. Display stands upright for tabletop use or is wall-mountable.



Lightning Sensor Placement

Sensor must be placed outside to observe outdoor conditions. Sensor is water resistant and is designed for general outdoor use, however, to extend its life place the sensor in an area protected from direct weather elements.

Hang the sensor using the integrated hanger, or by using string (not included) to hang it from a suitable location, like a well covered tree branch. The best location is 4 to 8 feet above the ground with permanent shade and plenty of fresh air to circulate around the sensor.

Important Placement Guidelines

- To maximize communication, install the rain gauge at least 3 ft (.9m) above the ground.
- Display and rain gauge must be within 100 ft (30 m) of each other.
- To ensure accurate temperature measurement, place lightning sensor out of direct sunlight and away from any heat sources or vents.
- Display and lightning sensor must be within 330 ft (100 m) of each other.
- To maximize wireless range, place units away from large metallic items, thick walls, metal surfaces, or other objects that may limit wireless communication.
- To prevent wireless interference, place all units at least 3 ft (.9 m) away from electronic devices (TV, computer, microwave, radio, etc.).

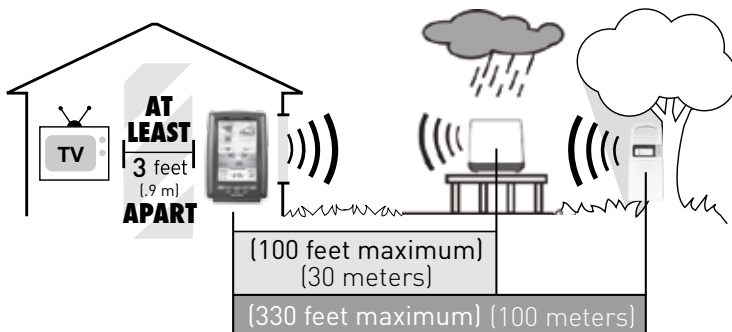

Lightning Sensor Installation Guidelines

False Detection

This sensor features advanced technology to distinguish between lightning strikes and interference, however in rare cases the sensor may "false detect" lightning activity due to interference. In these situations, verify there is no lightning in the area and then relocate the sensor. If the false detections persist, identify and relocate the source of interference or relocate the sensor.

Interference

The sensor features enhanced interference rejection capabilities to prevent false lightning detection. When the detector cannot detect lightning due to interference from nearby equipment, the sensor's interference indicator will flash.

- Electric motors (windshield wiper motor or fan motors in cars, hard drive and optical drive motors on your PC and AV equipment, well pumps, sump pumps)
- CRT monitors (PC monitors, TV's)
- Fluorescent light fixtures (turned off or on)
- Microwave ovens (while in use)
- PC's and mobile phones

WARNING: Take shelter IMMEDIATELY when lightning is present, whether or not it has been detected by the Lightning Detector. If you are concerned about lightning strikes, follow all safety precautions to keep yourself and others safe. DO NOT rely on this Lightning Detector as your only source for warnings about potentially deadly lightning strikes or other severe weather conditions.

Setup is Complete

The rain gauge and lightning sensor will now synchronize with the display. It may take a few minutes for synchronization to complete. Please refer to the troubleshooting section of this manual if anything appears to be functioning improperly.







Using the Weather Station

Learning Mode

Self-Calibrating Forecasting uses a unique algorithm to analyze changes in pressure over a time period (called Learning Mode) to determine your altitude. After 14 days, the (⚡) icon disappears from the display screen. At this point, the self-calibrated pressure is tuned in to your location and the unit is ready for superior weather prediction.

Weather Forecast

AcuRite's patented Self-Calibrating Forecasting provides your personal forecast of weather conditions for the next 12 to 24 hours by collecting data from the sensor in your backyard. It generates a forecast with pinpoint accuracy - personalized for your exact location.

<p>STORM CONDITIONS DEVELOPING</p>  <p>(Rain = Flashing)</p>	<p>SNOW LIKELY</p> 	<p>LIGHT RAIN LIKELY</p> 	<p>CLOUDY</p> 	<p>PARTLY CLOUDY</p> 	<p>CLEAR SKIES</p> 
---	---	---	--	---	---

View the complete list of icons at www.AcuRite.com/acurite-icons

Barometric Pressure

Subtle variations in barometric pressure greatly affect the weather. This weather station displays the current pressure with an arrow icon to indicate the direction the pressure is trending (FALLING, STEADY, or RISING).

Lightning Detection

The lightning sensor detects cloud-to-cloud, cloud-to-ground and intra-cloud lightning. When lightning is detected, the sensor will beep and the strike indicator will flash for each of the first 10 strikes. After 10 strikes, the sensor will enter silent mode but will continue to flash. The sensor will stay in silent mode for 2 hours after the last lightning detection.

The display will automatically show the most recent lightning event (TODAY, WEEK, MONTH, YEAR). The (⚡) icon appears on the display when lightning is detected and keeps a running count of lightning strikes detected. The display shows an estimate of the distance to the front of today's lightning-producing storm.

Programmable Weather Alarms

Each selectable weather category features an alarm option. When an alarm sounds, the display emits audible beeping and flashes the affected category, its alarm settings, and any other relevant data.

Alarms can be customized to alert you when your programmed value is reached. Alarms include:

OUTDOOR TEMPERATURE

OUTDOOR HUMIDITY

LIGHTNING STRIKES (ON/OFF only; ON by default)

RAINFALL

Setup an Alarm

1. Press and release the "SELECT" or the "SELECT" button until the reading for which you wish to set an alarm is shown on the display.
2. Press and release the "ALARMS" button until  is shown on the display.
4. Press and release the "SET ENTER" button. If applicable, the current LOW alarm value will flash on the display.
5. Press and release the "SELECT" or "SELECT" buttons to adjust the alarm's LOW value.
6. Press and release the "SET ENTER" button. The current HIGH alarm value will flash on the display.
7. Press and release the "SELECT" or "SELECT" buttons to adjust the alarm's HIGH value.
8. Press and release the "SET ENTER" button to save your adjustments.
9. Repeat steps 1-8, as needed.

Disable an Alarm

1. Press and release the "SELECT" or the "SELECT" button until the reading for which you wish to disable an alarm is shown on the display.
2. Press and release the "ALARMS" button until  is shown on the display.
3. Press and release the "SET ENTER" button until the display returns to normal viewing mode.

NOTE: To disable ALL alarms at once, press and HOLD the "ALARMS" button for 5 seconds.

High & Low Records

Today's high and low records are displayed for outdoor temperature and humidity. Today's records automatically clear at 12:00am midnight every day.

Historical records can also be viewed by accessing the records menu. Records include:

OUTDOOR TEMPERATURE
OUTDOOR HUMIDITY
BAROMETRIC PRESSURE
LIGHTNING STRIKES
RAINFALL

To view historical records, press and release the RECORDS button to cycle through all-time records. You will automatically exit the records menu if no buttons are pressed for 5 seconds.

To view or clear historical records for a specific reading, press and release the "SELECT" or the "SELECT" button until the desired reading is shown on the display. Then press and release the "RECORDS" button to cycle through available record values for that reading. The date and timestamp of the record are shown near the clock. You will automatically exit the records menu if no buttons are pressed for 5 seconds.

To clear a record, press and hold both the "SELECT" and "SELECT" buttons simultaneously for 2 seconds while viewing the record you wish to clear. Dashes display to confirm you have cleared the record.

Flooding Possible Indicator

This weather station features an algorithm that predicts when conditions are present for flooding. The indicator flashes on the display when these conditions are present.

Flood conditions include:

- > 3" (76.2 mm) in the last 7 days, and then >0.7" (17.78 mm) in the last 2 hours or 1" (25.4 mm) in the last 24 hours
- > 2.3" (58.4 mm) in the last 4 days, and then >0.7" (17.78 mm) in the last 2 hours or 1" (25.4 mm) in the last 24 hours
- > 1.5" (38.1 mm) in the last 2 days, and then >0.7" (17.78 mm) in the last 2 hours or 1" (25.4 mm) in the last 24 hours
- > 1.4" (35.6 mm) in the last 2 hours
- > 1.6" (40.6 mm) in the last 8 hours
- > 1.8" (45.7 mm) in the last 24 hours

Troubleshooting

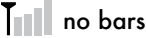
Problem	Possible Solution
<p>No lightning sensor or rain gauge reception</p> 	<p>If the wireless signal indicator shows no bars:</p> <ul style="list-style-type: none"> • Relocate the display and/or the lightning sensor. The units must be within 330 ft (100 m) of each other. • Relocate the display and/or the rain gauge. The units must be within 100 ft (30 m) of each other. • Make sure all units are placed at least 3 feet (.9 m) away from electronics that may interfere with the wireless communication (such as TVs, microwaves, computers, etc). • Use standard alkaline batteries (or lithium batteries in sensor when temperature is below -4°F/-20°C). Do not use heavy duty or rechargeable batteries. <p>NOTE: It may take a few minutes for display and sensor to synchronize after batteries are replaced.</p>
<p>Display screen not working</p>	<ul style="list-style-type: none"> • Check that the power adapter is plugged into the display and an electrical outlet.
<p>Outdoor temperature and/or humidity is flashing or showing dashes</p>	<p>Flashing of the outdoor temperature and/or humidity is generally an indication of wireless interference.</p> <ol style="list-style-type: none"> 1. Bring the lightning sensor indoors and remove at least one battery. Remove the power adapter and/or batteries from the display. 2. Reinstall the battery into the lightning sensor. 3. Reinstall the power adapter/batteries into the display. 4. Let the units sit within a couple feet of each other for a few minutes to gain a strong connection.
<p>Inaccurate temperature or humidity</p>	<ul style="list-style-type: none"> • Make sure the lightning sensor is placed out of direct sunlight and away from any heat sources or vents (see page 13).
<p>Can the rain gauge remain outdoors in freezing temperatures?</p>	<p>No, the rain gauge should be brought indoors when there is a possibility of freezing temperatures. Water expands when it freezes. If any water is left within the rain gauge during a freeze, it can crack the plastic and cause permanent damage.</p>

Troubleshooting

Problem	Possible Solution
Inaccurate forecast	<ul style="list-style-type: none">• Weather Forecast icon predicts conditions for the next 12 to 24 hours, not current conditions.• Has the ☁️ icon disappeared from the display? Learning Mode must complete before forecast and pressure will be accurate.• Allow unit to run continuously for 33 days. Battery removal or resetting the display will restart Learning Mode. After 14 days, forecast should be fairly accurate, however Learning Mode calibrates for a total of 33 days.
Interference Indicator is flashing	<ul style="list-style-type: none">• Relocate the lightning sensor.• Make sure the lightning sensor is placed at least 3 feet (.9 m) away from electronics that may cause interference (see page 14).

If your AcuRite product does not operate properly after trying the troubleshooting steps, visit www.AcuRite.com or call (877) 221-1252 for assistance.

Care & Maintenance

Display Care

Clean with a soft, damp cloth. Do not use caustic cleaners or abrasives. Keep away from dust, dirt and moisture. Clean ventilation ports regularly with a gentle puff of air.

Lightning Sensor Care

Clean with a soft, damp cloth. Do not use caustic cleaners or abrasives.

Rain Gauge Care

Clean with a soft damp cloth. Do not use caustic cleaners or abrasives that could mar the polished surface of the rain gauge or tipping cups. If the collector becomes dirty, rain water may not flow correctly through the rain gauge. Some environmental conditions may require more frequent, periodic cleaning of the collector. After a cleaning, it is recommended to apply a small amount of liquid water repellent (found in the automotive section) to the tipping cups and collector funnel for optimal rain collection.

The rain gauge cannot be used in the winter during freezing temperatures. Water expands when it freezes. If any water is left within the unit during a freeze, it can crack the plastic and permanently damage the unit.

Calibration

Calibrate Temperature, Humidity & Barometric Pressure

The outdoor temperature and humidity readings, and barometric pressure can be calibrated on the display to improve accuracy. Calibration can improve accuracy when sensor placement or environmental factors impact the data accuracy.

1. To access calibration mode, press AND HOLD the "SELECT" (down arrow), "SET" (ENTER), and "SELECT" (up arrow) buttons simultaneously for at least 5 seconds.
2. To adjust the currently selected (flashing) item, press and release the "SELECT" (down arrow) or "SELECT" (up arrow) buttons to calibrate the data value higher or lower from the actual reading.
3. To save your adjustments, press and release the "SET" (ENTER) button to adjust the next preference. The "مؤ" icon will remain illuminated next to calibrated values.

The preference set order is as follows:

OUTDOOR TEMPERATURE

OUTDOOR HUMIDITY

BAROMETRIC PRESSURE (must be set to MANUAL mode to calibrate)*

*To change from auto to manual pressure mode and vice versa, press AND HOLD the "SET" (ENTER) button for 8-10 seconds. The display indicates the current pressure mode selected, "auto" or "manual".

After 5-10 seconds of inactivity, the display will save the adjustments and exit calibration mode.

NOTE: Calibrations will be erased if the display is reset or if batteries are removed and the power adapter is unplugged.

Calibrate the Rain Gauge

The rain gauge can be calibrated to improve accuracy.

Items Needed: rain gauge, display, plastic cup, pin, screw driver

1. First, place the rain gauge on a level surface.
2. Place the display close by so you can monitor it during calibration.
3. Make a pin hole in the bottom of a plastic cup. Hold the cup over the rain gauge and fill it with exactly 1 cup (8 oz.) of water, allowing the water to slowly drip into the rain gauge. You should hear the internal cups tipping and see the water drain through the rain gauge.
4. A few seconds after each cup tip, the display will display rainfall in approximately 0.01" (0.2 mm) or more increments.
5. The cup of water should take a few minutes to empty; a quicker period will result in an inaccurate calibration. Try to simulate a normal steady rainfall. When the cup is empty of water, the display should register 1.68" (42.67 mm).

Tips

- There should be nearly an equal number of water drops between cup tips. If not, then adjust the calibration screws beneath the tipping lever until an equal number of water drops are tipping the cups. Then, restart the calibration procedure.
- If you don't hear the cups tipping and see water dripping alternately out of each drain, there may be an issue with the rain gauge or its adjustment.

Adjustment

If the rain gauge doesn't register close to 1.68" (42.67 mm) after the cup is empty, make an EQUAL adjustment to the two calibration screws, located beneath the tipping cups. Turn screws counter-clockwise to increase rainfall; turn screw clockwise to decrease rainfall.

- To adjust the rainfall reading by 2% turn both screws 1/4 of a turn.
- To adjust the rainfall reading by 4% turn both screws 1/2 of a turn.
- To adjust the rainfall reading by 8% turn both screws 1 full turn.

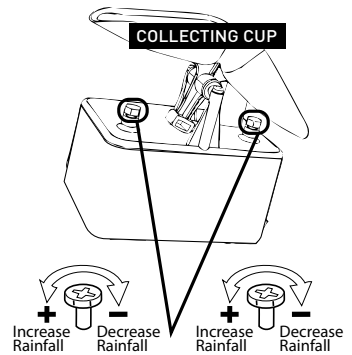

2 CALIBRATION SCREWS

Specifications

TEMPERATURE RANGE	Outdoor: -40°F to 158°F; -40°C to 70°C
HUMIDITY RANGE	Outdoor: 1% to 99%
LIGHTNING DETECTION RANGE	1 - 25 miles / 1.6 - 40km
RAINFALL MEASUREMENT	0.01 inches (0.25 mm) and up
WIRELESS RANGE	Lightning Sensor: 330ft / 100m depending on home construction materials
	Rain Gauge: 100ft / 30m depending on home construction materials
OPERATING FREQUENCY	433 MHz
POWER	Display: 5V, 100mA adapter 3 x AA alkaline batteries (optional)
	Lightning Sensor: 4 x AA alkaline or lithium batteries
	Rain Gauge: 2 x AA alkaline or lithium batteries
DATA REPORTING	Outdoor temperature & humidity: 36 second updates
	Rain Gauge: 60 second updates
	Lightning Sensor: 24 second updates during normal conditions; 8 seconds once lightning detected

FCC Information

This device complies with part 15 of FCC rules. Operation is subject to the following two conditions:

- 1- This device may NOT cause harmful interference, and
- 2- This device must accept any interference received, including interference that may cause undesired operation.

WARNING: Changes or modifications to this unit not expressly approved by the party responsible for compliance could void the user's authority to operate the equipment.

NOTE: This equipment has been tested and found to comply with the limits for a Class B digital device, pursuant to Part 15 of the FCC rules. These limits are designed to provide reasonable protection against harmful interference in a residential installation. This equipment generates, uses and can radiate radio frequency energy and, if not installed and used in accordance with the instructions, may cause harmful interference to radio communications. However, there is no guarantee that interference will not occur in a particular installation. If this equipment does cause harmful interference to radio or television reception, which can be determined by turning the equipment off and on, the user is encouraged to try to correct the interference by one or more of the following measures:

- Reorient or relocate the receiving antenna.
- Increase the separation between the equipment and the receiver.
- Connect the equipment into an outlet on a circuit different from that to which the receiver is connected.
- Consult the dealer or an experienced radio/TV technician for help.

NOTE: The manufacturer is not responsible for any radio or TV interference caused by unauthorized modifications to this equipment. Such modifications could void the user authority to operate the equipment.

This device complies with Industry Canada licence-exempt RSS standard(s).

Operation is subject to the following two conditions:

- (1) This device may not cause interference, and
- (2) This device must accept any interference received, including interference that may cause undesired operation of the device.

Customer Support

AcuRite customer support is committed to providing you with best-in-class service. **For assistance**, please have the model number of this product available and contact us in any of the following ways:



(877) 221-1252

Visit us at www.AcuRite.com

- ▶ Installation Videos
- ▶ Register your Product
- ▶ Instruction Manuals
- ▶ Support User Forum
- ▶ Replacement Parts
- ▶ Submit Feedback & Ideas

IMPORTANT

PRODUCT MUST BE REGISTERED
TO RECEIVE WARRANTY SERVICE

PRODUCT REGISTRATION

Register online to receive 1 year warranty protection

www.AcuRite.com

Limited 1-Year Warranty

AcuRite is a wholly owned subsidiary of Chaney Instrument Company. For purchases of AcuRite products, AcuRite provides the benefits and services set forth herein. For purchases of Chaney products, Chaney provides the benefits and services set forth herein.

We warrant that all products we manufacture under this warranty are of good material and workmanship and, when properly installed and operated, will be free of defects for a period of one year from the date of purchase.

Any product which, under normal use and service, is proven to breach the warranty contained herein within ONE YEAR from date of sale will, upon examination by us, and at our sole option, be repaired or replaced by us. Transportation costs and charges for returned goods shall be paid for by the purchaser. We hereby disclaim all responsibility for such transportation costs and charges. This warranty will not be breached, and we will give no credit for products which have received normal wear and tear not affecting the functionality of the product, been damaged (including by acts of nature), tampered, abused, improperly installed, or repaired or altered by others than our authorized representatives.

Remedy for breach of this warranty is limited to repair or replacement of the defective item(s). If we determine that repair or replacement is not feasible, we may, at our option, refund the amount of the original purchase price.

THE ABOVE-DESCRIBED WARRANTY IS THE SOLE WARRANTY FOR THE PRODUCTS AND IS EXPRESSLY IN LIEU OF ALL OTHER WARRANTIES, EXPRESS OR IMPLIED. ALL OTHER WARRANTIES OTHER THAN THE EXPRESS WARRANTY SET FORTH HEREIN ARE HEREBY EXPRESSLY DISCLAIMED, INCLUDING WITHOUT LIMITATION THE IMPLIED WARRANTY OF MERCHANTABILITY AND THE IMPLIED WARRANTY OF FITNESS FOR A PARTICULAR PURPOSE.

We expressly disclaim all liability for special, consequential, or incidental damages, whether arising in tort or by contract from any breach of this warranty. Some states do not allow the exclusion or limitation of incidental or consequential damages, so the above limitation or exclusion may not apply to you.

We further disclaim liability from personal injury relating to our products to the extent permitted by law. By acceptance of any of our products, the purchaser assumes all liability for the consequences arising from their use or misuse. No person, firm or corporation is authorized to bind us to any other obligation or liability in connection with the sale of our products. Furthermore, no person, firm or corporation is authorized to modify or waive the terms of this warranty unless done in writing and signed by a duly authorized agent of ours.

In no case shall our liability for any claim relating to our products, your purchase or your use thereof, exceed the original purchase price paid for the product.

Applicability of Policy

This Return, Refund, and Warranty Policy applies only to purchases made in the United States and Canada. For purchases made in a country other than the United States or Canada, please consult the policies applicable to the country in which you made your purchase.

Additionally, this Policy applies only to the original purchaser of our products. We cannot and do not offer any return, refund, or warranty services if you buy products used or from resale sites such as eBay or Craigslist.

Governing Law

This Return, Refund, and Warranty Policy is governed by the laws of the United States and the State of Wisconsin. Any dispute relating to this Policy shall be brought exclusively in the federal or State courts having jurisdiction in Walworth County, Wisconsin; and purchaser consents to jurisdiction within the State of Wisconsin.

ACU>RITE®



Weather
Stations



Temperature
& Humidity



Weather
Alert Radio



Kitchen
Thermometers
& Timers



Clocks

It's more than accurate, it's ACU>RITE.

AcuRite offers an extensive assortment of precision instruments, designed to provide you with information you can depend on to Plan your day with confidence™.

www.AcuRite.com

©Chaney Instrument Co. All rights reserved. AcuRite is a registered trademark of the Chaney Instrument Co., Lake Geneva, WI 53147. All other trademarks and copyrights are the property of their respective owners. AcuRite uses patented technology. Visit www.AcuRite.com/patents for details.