

SPECIFICATION SHEET

7000 SERIES WITH SKIP-A-DAY FEATURE RESERVE POWER OPTIONAL 24 HOUR TIME SWITCH

APPLICATIONS

- Lighting, pumps.
- Signs, heatings.
- Air conditioning
- Automatic ON/OFF control when operation is required at the same time every day, with optional versatility of one to six days omission.

FEATURES

SCHEDULING:

Minimum ON setting is 20 minutes with minimum OFF setting at 75 minutes. Dial accommodates up to 12 pairs of trippers. One pair included.

SKIP-A-DAY:

Omit operations on any day with a 7-spoke wheel marked with days of week. 3 omitting screws included.

MANUAL OVERRIDE:

Until the next regularly scheduled ON or OFF, automatic operation then resumes.

OPTIONAL RESERVE POWER:

"L" models keep dial on time up to 16 hours during power outage.

SPECIFICATIONS

INPUT VOLTAGE:

120 or 208-277 VAC 60 Hz varies by model.

TIMING ACCURACY:

Line frequency.

TERMINAL RANGE:

#8 - #14 AWG.

OPERATING TEMPERATURE:

-40 °F to 165 °F (-40 °C to 74 °C).

POWER CONSUMPTION:

3 watts, 5 watts for "L" models maximum.

ENCLOSURE:

Lockable hasp. Type varies by model (see page 557 for enclosure dimensions).

OTHER MOUNTINGS:

Intermatic[®] Adaptor Plate model #IAP allows any 7100 and 7200 series (except "L" models) to fit into an Intermatic case.



WIRE DIAGRAM

7100 & 7102

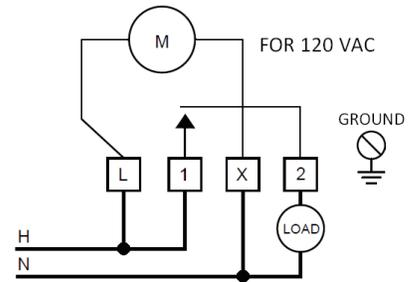

ORDERING INFO

CAT. NO.	UPC CODE	INPUT SUPPLY (VAC) 60Hz	OUTPUT CONTACTS	ENCLOSURE TYPE
7100	10001	120	SPST	Metal Indoor NEMA 1
7102	10002	208-277	SPST	Metal Indoor NEMA 1
7200	11001	120	DPST	Metal Indoor NEMA 1
7200-O	10512	120	DPST	Metal Indoor/Outdoor NEMA 3
7202	11002	208-277	DPST	Metal Indoor NEMA 1
7202-O	10509	208-277	DPST	Metal Indoor/Outdoor NEMA 3
7300	12001	120	3PST	Metal Indoor/Outdoor NEMA 3
7302	12002	208-277	3PST	Metal Indoor/Outdoor NEMA 3
7120	13001	120	SPDT	Metal Indoor NEMA 1
7122	13002	208-277	SPDT	Metal Indoor NEMA 1
7220	14001	120	DPDT	Metal Indoor NEMA 1
7222	14002	208-277	DPDT	Metal Indoor NEMA 1

WITH RESERVE POWER

7200L	19003	120	DPST	Metal Indoor NEMA 1
7202L	19004	208-277	DPST	Metal Indoor NEMA 1
7300L	19005	120	3PST	Metal Indoor/Outdoor NEMA 3
7302L	19006	208-277	3PST	Metal Indoor/Outdoor NEMA 3
7120L	19007	120	SPDT	Metal Indoor NEMA 1
7220L	19009	120	DPDT	Metal Indoor NEMA 1
7222L	19011	208-277	DPDT	Metal Indoor NEMA 1

Replacement Trippers Order #P49 for a pair of ON/OFF per dial. Additional ON/OFF trippers per dial order #P47. 3 omitting screws #53005 supplied.

Replacement Motor #101 (120V) & #201 (208-277V). For "L" models #36 (120V) & #46 (208-277V). For Astronomic Conversion: Order #Z KIT for 7000 Series.

Conversion

Astronomic dial. Consult factory for correct number for your latitude

SPECIFICATION SHEET

7000 SERIES WITH SKIP-A-DAY FEATURE RESERVE POWER OPTIONAL 24 HOUR TIME SWITCH

APPLICATIONS

- Lighting, pumps.
- Signs, heatings.
- Air conditioning
- Automatic ON/OFF control when operation is required at the same time every day, with optional versatility of one to six days omission.

FEATURES

SCHEDULING:

Minimum ON setting is 20 minutes with minimum OFF setting at 75 minutes. Dial accommodates up to 12 pairs of trippers. One pair included.

SKIP-A-DAY:

Omit operations on any day with a 7-spoke wheel marked with days of week. 3 omitting screws included.

MANUAL OVERRIDE:

Until the next regularly scheduled ON or OFF, automatic operation then resumes.

OPTIONAL RESERVE POWER:

"L" models keep dial on time up to 16 hours during power outage.

SPECIFICATIONS

INPUT VOLTAGE:

120 or 208-277 VAC 60 Hz varies by model.

TIMING ACCURACY:

Line frequency.

TERMINAL RANGE:

#8 - #14 AWG.

OPERATING TEMPERATURE:

-40 °F to 165 °F (-40 °C to 74 °C).

POWER CONSUMPTION:

3 watts, 5 watts for "L" models maximum.

ENCLOSURE:

Lockable hasp. Type varies by model (see page 557 for enclosure dimensions).

OTHER MOUNTINGS:

Intermatic[®] Adaptor Plate model #IAP allows any 7100 and 7200 series (except "L" models) to fit into an Intermatic case.



WIRE DIAGRAM

7120 & 7122

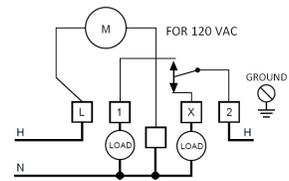

7202

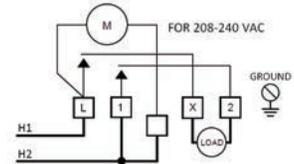

7200

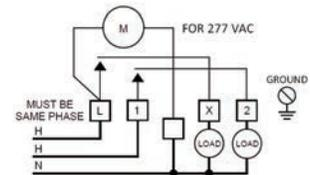
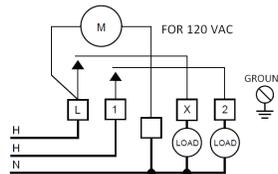

7222

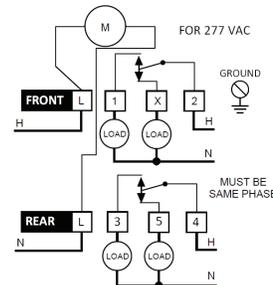
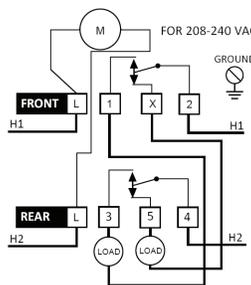

7220

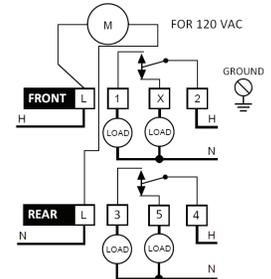

7300

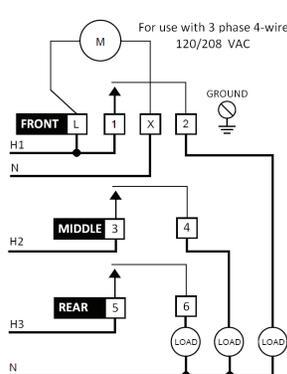

7302

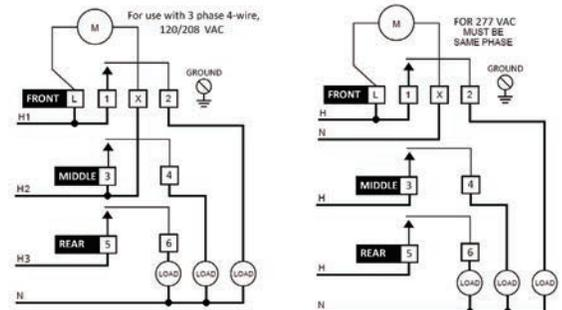

CONTACT RATINGS

TYPE	VOLTAGE (VAC)	CONTACT RATING
General Purpose	120 -277	40A
Resistive	120 -277	40A
Tungsten	120	40A
Ballast	120-277	20A
Pilot Duty	120 -277	1000VA
Motor	120	2HP
	240	5HP