



VR Series Power Conversion Modules

Overview:

The unit converts a 24VAC and/or 24VDC input into a regulated 5VDC or 12VDC output.

Reference Chart:

Altronix Model Number	Input	Output	Battery Charging	Cable Assembly	Screw Terminal	Spring Terminal
VR1	24VAC/20VA or higher / 24VDC	12VDC @ 1A max.	-	✓	-	-
VR1T	24VAC/20VA or higher / 24VDC	12VDC @ 1A max.	-	-	-	✓
VR2T	24VAC/20VA or higher / 24VDC	12VDC @ 0.5A max.	-	-	-	✓
VR3T	24VDC	12VDC @ 2A max.	-	-	✓	-
VR4T	24VDC	12VDC @ 3A max.	-	-	✓	-
VR5T	24VAC/50VA or higher / 24VDC	12VDC @ 3A max.	-	-	-	✓
VR5BT	24VAC/50VA or higher / 24VDC	12VDC @ 3A max.	✓	-	-	✓
VR1TM5	16VAC/24VAC/20VA or higher / 12 or 24VDC	5VDC @ 1A max.	-	-	-	✓

Specifications:

Agency Listing:

- CE European Conformity.

Input:

- Input 24VAC or 24VDC.

Output:

- 5VDC (VR1TM5) or 12VDC output.
- Filtered and electronically regulated output.
- Built-in overload protection.

Applications:

- Power for 12VDC CCTV cameras and accessories, Fiber Optic Transmitters, REX PIR's, Prox Readers, etc.



Visual Indicators:

- Power LED indicator.

Features:

- Modular connector/cable assembly facilitates ease of wiring.
- Compact design allows for integration in a wide range of camera housings.

Dimensions (W x D x H approx.):

VR5T / VR5BT:

3.375" x 2.5" x 1.125" (85.7mm x 63.5mm x 28.6mm)

All other units:

1.625" x 2.375" x 1" (41.3mm x 60.3mm x 25.4mm)

Installation Instructions:

Installing VR1 (Fig. 1, pg. 1):

1. Mount unit in proximity to the device. Affix one side of velcro (supplied) to the unit and place the second side of the velcro in the desired location.
2. Connect Yellow lead and Purple lead to 24VAC transformer or 24VDC power source*.
3. Measure output voltage and check polarity before connecting devices, in order to avoid potential damage.
4. Connect Red lead [Pos. +] and Black lead [Neg. -] to device to be powered.
5. LED will illuminate when power is present.

* For CE compliance use a Class 2 Power-Limited Power Source.

Fig. 1

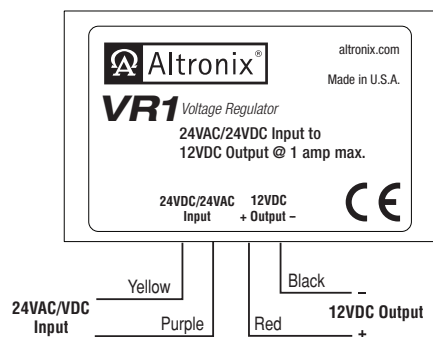

Installing VR1T, VR1TM5, VR2T (Figs. 2-4, pg. 2):

1. Mount unit in proximity to the device. Affix one side of velcro (supplied) to unit and place the second side of the velcro in the desired location.
2. Connect 24VAC transformer or 24VDC source* to the terminals marked [24VDC/24VAC Input].
3. Measure output voltage and check polarity before connecting devices, in order to avoid potential damage.
4. Connect device to be powered to the terminals marked [+ Output -].
5. LED will illuminate when power is present.

* For CE compliance use a Class 2 Power-Limited Power Source.

Fig. 2

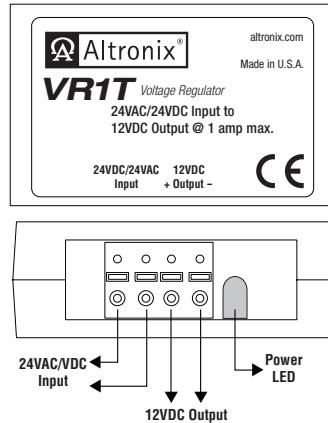

Fig. 3

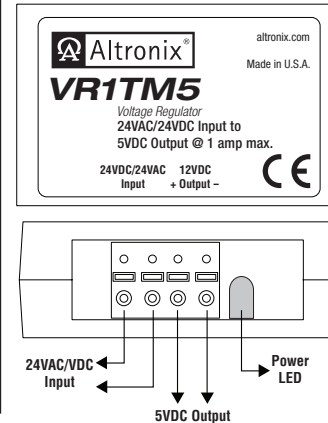
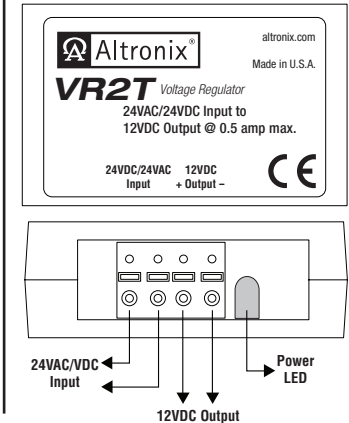

Fig. 4



Installing VR3T, VR4T (Figs. 5-6, pg. 2):

1. Mount unit in proximity to the device. Affix one side of velcro (supplied) to the unit and place the second side of the velcro in the desired location.
2. Connect 24VDC source* to the terminals marked [24VDC + Input -].
3. Measure output voltage and check polarity before connecting devices, in order to avoid potential damage.
4. Connect device to be powered to the terminals marked [- Output +].
5. LED will illuminate when power is present.

* For CE compliance use a Class 2 Power-Limited Power Source.

Fig. 5

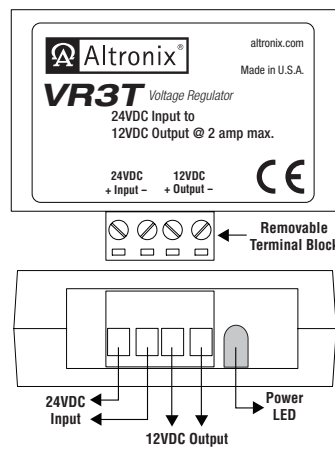
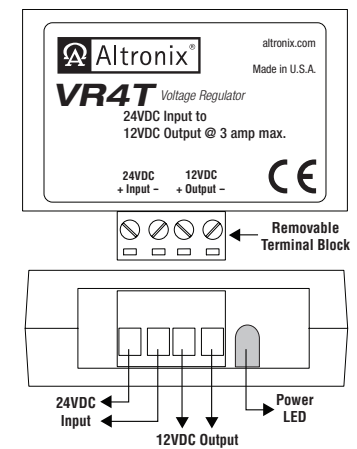

Fig. 6



Installing VR5T, VR5BT (Figs. 7-8, pg. 2):

1. Mount unit in proximity to the device. Use a proper fastener and/or wall anchor when securing unit to the wall.
2. Connect 24VAC transformer or 24VDC source* to the terminals marked [Input].
3. Measure output voltage and check polarity before connecting devices, in order to avoid potential damage.
4. Connect device to be powered to the terminals marked [-OUT +].
5. LED will illuminate when power is present.
6. For VR5BT (Fig. 8, pg. 2) - when the use of stand-by batteries is desired, they must be lead acid or gel type. Connect battery to terminals marked [- BAT +].

* For CE compliance use a Class 2 Power-Limited Power Source.

Fig. 7

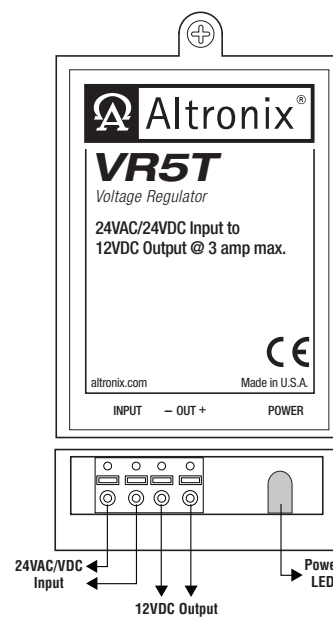
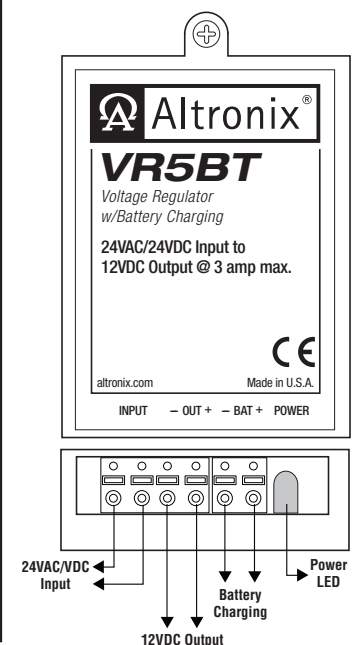

Fig. 8



Altronix is not responsible for any typographical errors. Product specifications are subject to change without notice.

