



**LUMA** SERIES  
SQUARE

**HUBBELL**  
Outdoor Lighting



**HUBBELL**  
Lighting



FORM | PERFORMANCE | VISUAL COMFORT  
NO COMPROMISE

Lumasquare is available in two low profile housing sizes and four lumen outputs for optimized performance and scalability to meet a variety of applications and mounting heights.

A specially designed acrylic lens provides a blended, non-pixelated light for unprecedented visual comfort.

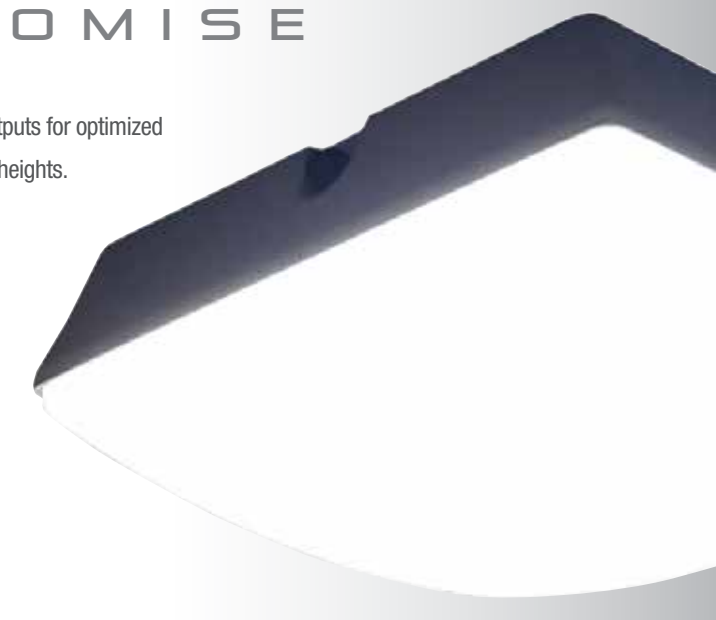

TWO SIZES FOR SCALABILITY AND  
SEAMLESS RETROFITS

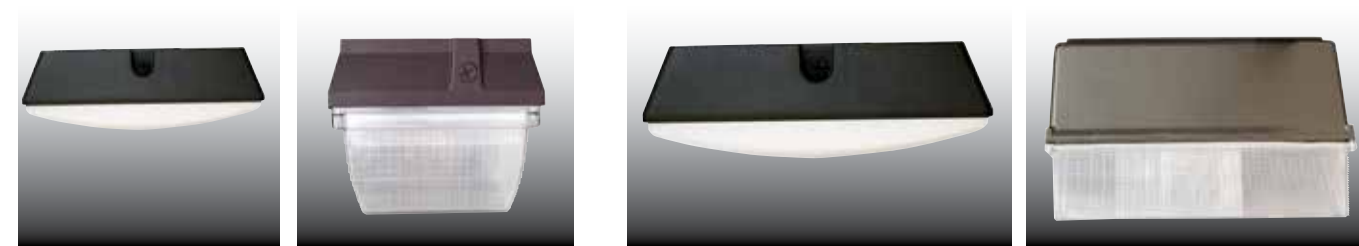

Lumasquare provides a seamless retrofit solution for traditional HID sources up to 250W. In addition, Lumasquare effectively covers unsightly existing HID luminaire installation footprints while saving energy and providing low glare illumination.

CANOPY REDEFINED

Lumasquare luminaires provide a seamless blend of performance, visual comfort, controls and accessory options in an elegant/low profile form factor to enhance the environment in which they occupy.



LSQ1



LSQ2

BEFORE



AFTER



## SUPERIOR DESIGN



4" junction box or 3/4" threaded pendant mount with easy install mounting plate and hook

Mounting hanger for easy 4 step installation

Four 1/2" threaded hubs for surface conduit wiring



SiteSync™ wireless lighting control delivers flexible control strategies for reducing power consumption and minimizing maintenance costs while delivering the right light levels with a simple and affordable wireless solution.



## EMERGENCY EGRESS PHOTOCONTROL WIRELESS+SENSORS

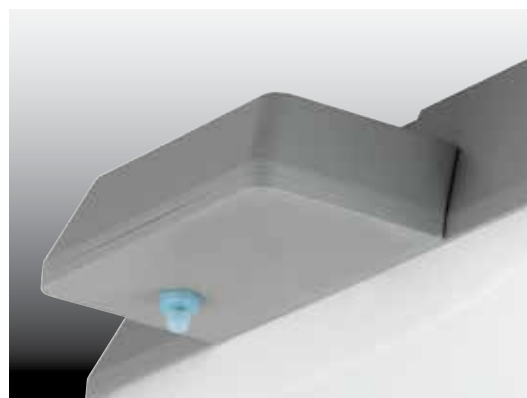

Battery back up option available on LSQ2 versions. Delivers life safety code average illuminance of 1.0 fc.

- Integral to fixture
- Manual test button
- Lithium iron phosphate battery
- Optional heater rated down to -30°C



Photocontrol option available for energy-saving dusk-to-dawn operation. Installs in the top conduit hub.



Occupancy sensor provides significant energy savings by lowering light levels or only lighting the application area where and when it's needed.

## SIMPLE INSTALLATION



1 Mount plate to junction box.

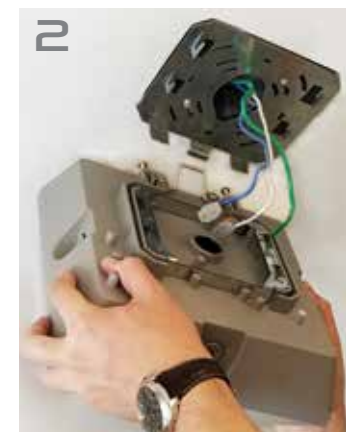

2 Hang fixture on mounting plate with provided integral hook.

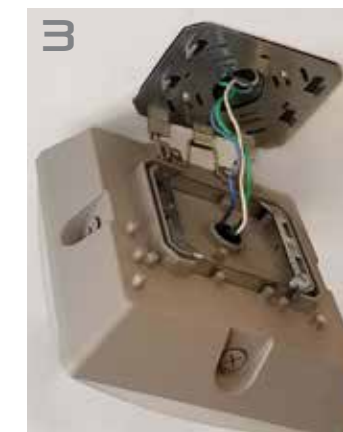

3 Complete wiring connections.



4 Two mounting screws close and secure fixture to the mounting bracket.

PERFORMANCE

LSQ1

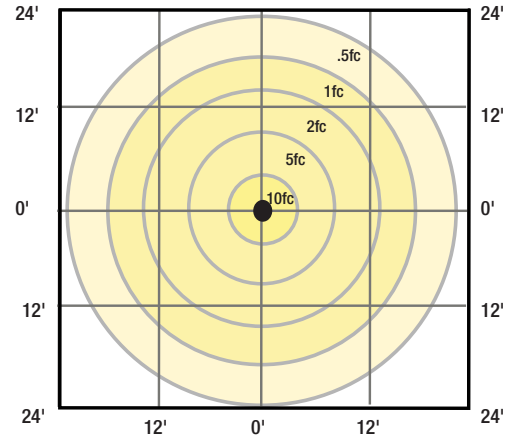

Mounting Height 12ft

Catalog Number	Equivalency		Distribution	CCT	Voltage	Mounting Height
	MH	HPS				
LSQ1-40-4K	175w	175w	V	4000K	120-277V	8-12ft

Consult ordering info and specification sheet for additional configurations.

LSQ2

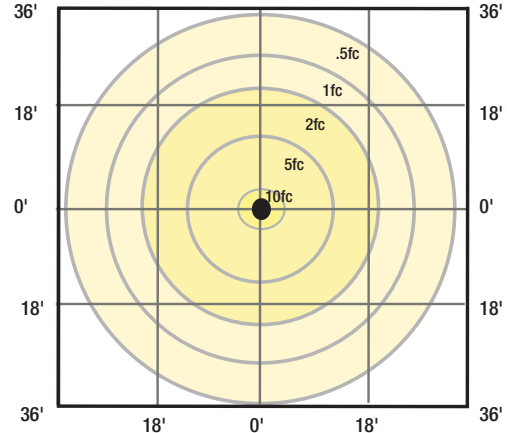

Mounting Height 18ft

Catalog Number	Equivalency		Distribution	CCT	Voltage	Mounting Height
	MH	HPS				
LSQ2-70-4K	250w	250w	V	4000K	120-277V	18-24ft

Consult ordering info and specification sheet for additional configurations.

FINISH OPTIONS

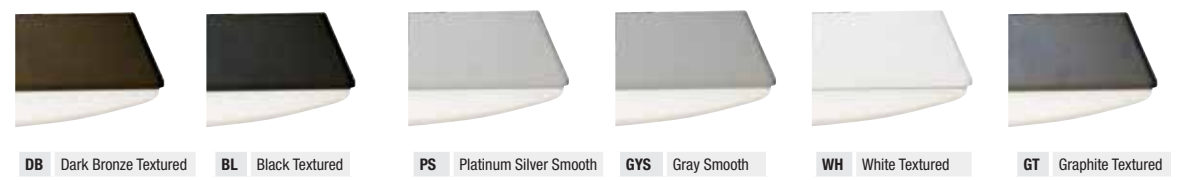

ORDERING INFORMATION

FAMILY	CCT/CRI	VOLTAGE	COLOR/FINISH	CONTROL OPTIONS	OPTIONS
LSQ1-25 Size 1, 25w / 3,000lm	3K7 3000K, 70CRI	UNV 120V-277V	DB Dark Bronze Textured	PCU Button Photocontrol (120-277V)	E <sup>1,4</sup> Battery Backup Unit (0°C)
LSQ1-40 Size 1, 40w / 4,500lm	4K7 4000K, 70CRI	120 120V	BL Black Textured	SCO <sup>2</sup> Sensor Control (On/Off)	EH <sup>1,4</sup> Battery Backup Unit (-30°C)
LSQ2-55 Size 2, 55w / 7,000lm	5K7 5000K, 70CRI	208 208V	WH White Textured	SCP <sup>2,5</sup> Sensor Control, Programmable (Dim)	F <sup>6</sup> Fusing (voltage specific)
LSQ2-70 Size 2, 75w / 9,000lm		240 240V	GYS Gray Smooth	SWP <sup>1,3</sup> SiteSync, Pre-Commission	2DR <sup>1</sup> Dual Drivers
		277 277V	PS Plat. Silver Smooth	SWPM <sup>1,3</sup> SiteSync, Pre-Commission w/Motion Sensor	2PF <sup>1,6</sup> Dual Power Feed
		UHV 347/480	GT Graphite Textured	SWF <sup>1,3</sup> SiteSync, Field Commission	SPC Polycarbonate Vandal Shield
			CC Custom Color	SWFM <sup>1,3</sup> SiteSync, Field Commission w/Motion Sensor	

Specify MTG HT for SCO/SCP & SWPM  
 8F Up to 8ft mounting height  
 20F Up to 20ft mounting height

<sup>1</sup> Available in SCL2-55 and SCL2-70 only  
<sup>2</sup> Available in 120V-277V only  
<sup>3</sup> Available in 120V, 277V or 347V only  
<sup>4</sup> Available in 120V or 277V only  
<sup>5</sup> Must order minimum of one remote control (SCP-REMOTE) to program dimming settings, 0-10V fully adjustable dimming with automatic daylight calibration and different beam delay settings (120-277V only)  
<sup>6</sup> Comes with Dual Driver (2DR) option

ACCESSORIES
SCP-REMOTE Remote control for SCP option. Order a minimum of one per project to program and control fixtures
SCP-PC Polycarbonate Vandal Shield

STOCK

Catalog Number	Description
LSQ1-40-4K-PCU	40 watt, 4600 Lumen, 4000K, 70 CRI, 120-277V, Dark Bronze Textured, Photocell
LSQ1-40-4K-GYS-PCU	40 watt, 4600 Lumen, 4000K, 70 CRI, 120-277V, Gray Smooth, Photocell
LSQ2-70-4K-PCU	75 watt, 9300 Lumen, 4000K, 70 CRI, 120-277V, Dark Bronze Textured, Photocell
LSQ2-70-4K-GYS-PCU	75 watt, 9300 Lumen, 4000K, 70 CRI, 120-277V, Gray Smooth, Photocell

DIMENSIONS

LSQ1

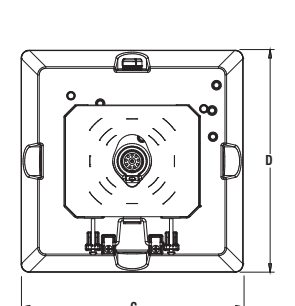
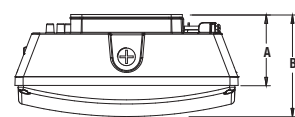

A	B	C	D	E	Weight
3.0"	4.0"	10.0"	10.0"	13.5"	10 lbs.
76.2 mm	101.6 mm	254 mm	254 mm	343 mm	4.5 kg

LSQ2

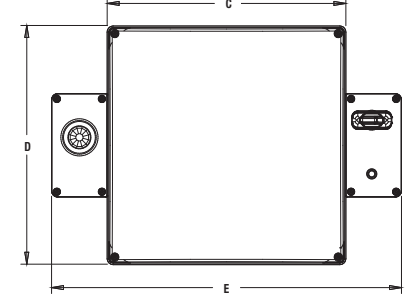
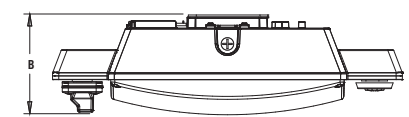
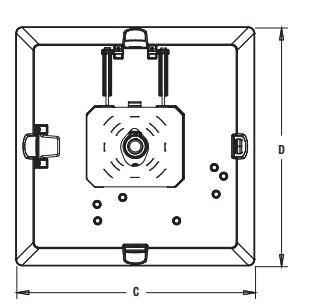
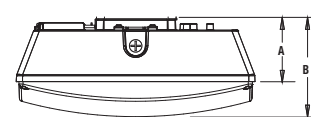

A	B	C	D	E	Weight
4.0"	6.0"	14.8"	14.8"	21.9"	15.5 lbs.
101.6 mm	152.4 mm	375 mm	375 mm	556 mm	7.0 kg



**HUBBELL**  
Lighting

ALERA LIGHTING

ARCHITECTURAL AREA LIGHTING

BEACON PRODUCTS

COLUMBIA LIGHTING

COMPASS

DUAL-LITE

HUBBELL CONTROL SOLUTIONS

HUBBELL INDUSTRIAL LIGHTING

HUBBELL OUTDOOR LIGHTING

KIM LIGHTING

KURT VERSEN

LITECONTROL

PRESCOLITE

WHITEWAY



**HUBBELL**  
Outdoor Lighting

701 Millennium Blvd. Greenville, SC 29607  
Tel 864.678.1000  
[www.hubbelloutdoor.com](http://www.hubbelloutdoor.com)

HOL00339 5K November 29, 2017 4:07 PM

Copyright © 2017 Hubbell Outdoor Lighting, a division of Hubbell Lighting, Inc. All rights reserved.  
Please refer to online specifications for most up-to-date content as specifications are subject to change without notice.  
Due to our continued efforts to improve our products, product specifications are subject to change without notice.