

Stake-less earth / ground testing

NEW DET14C and DET24C CLAMPS GETTING-AROUND ANY CHALLENGE



- What is stake-less testing?
- How does it work?
- Where and how can it be used?
- What are the potential sources of error?
- What are the benefits of stake-less testing?
- What are the benefits of the DET14C and DET24C?
- DET14C and DET24C range selection

Introduction

Megger has been designing, manufacturing and selling earth / ground testers for well over 50 years. It was Dr George Tagg who pioneered earth testing at Megger, and since Megger has been at the forefront of innovative development and design.

From many years of supplying instruments for the tests involved, Megger can provide advice to help you make specific tests. In addition to this simple, easy to read application note, a more detailed guide to earth testing called "Getting down to earth" is available, covering many other test techniques.

Alternatively visit the Megger earth testing website www.megger.com/det for everything you need to know about earth testing and the Megger range of earth testers.



What is stake-less testing?

Stake-less testing is one of many methods of measuring earth electrode resistance. However what sets this method apart from all other earth electrode test methods is that it is the only method that does not require the use of auxiliary test electrodes or test leads. Since many earth electrodes are in locations surrounded by concrete or tarmac this is of real benefit. The lazy-spike method works well, but can easily be influenced by steel reinforcement or buried metal pipes.

How does it work?

The DET14C and DET24C are clamp-on earth / ground testers designed to quickly test the resistance of earth / ground electrodes, but how do they make that measurement?

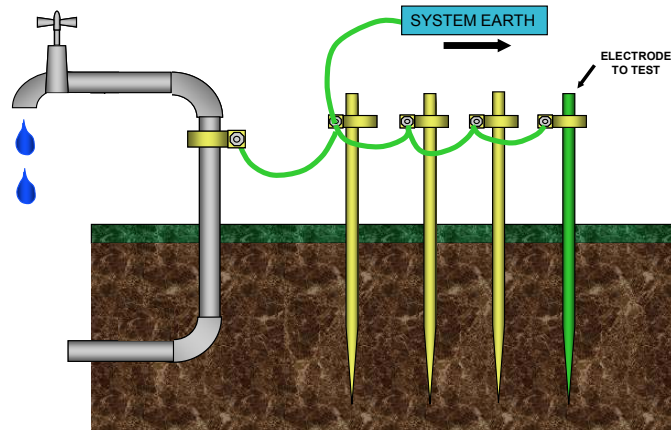
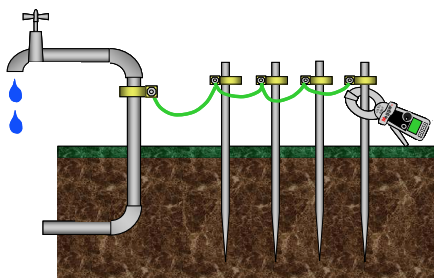

Figure 1

Figure 1 shows a typical earth / ground electrode system. (This is intended to be representative, in some countries bonding a metal water pipe to the electrode system is prohibited) In this case, you might want to test the electrode on the right coloured green. Normally this would be done by either disconnecting the electrode and applying a 3 pole test method, such as the fall-of-potential test, or using the Megger ART* method.



Either way the test would require the use of auxiliary test spikes, which in concrete locations is not always practical.

The solution is to use a Megger earth clamp-on tester. Simply clamp around the electrode and take a measurement. However it is important the user understands how the measurement relates to the actual electrode earth / ground resistance.

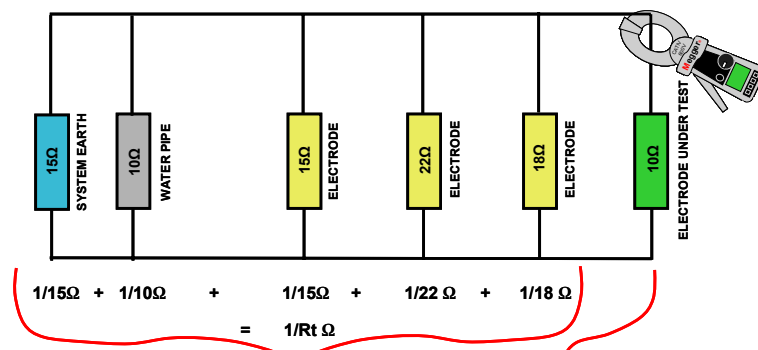

Figure 2

$$\text{DET14C measurement} = R_{eq} = 2.9926 + 10\Omega(\text{E.U.T})$$

$$\text{DET14C measurement} = 12.99\Omega$$

Figure 2 shows the equivalent circuit for the scenario in Figure 1. Each element in the circuit; water pipe, system earth and other electrodes all have a resistance to earth. The DET earth clamp treats these elements as being in parallel and in series with the electrode being tested. The instrument therefore will measure the whole loop resistance and not just the electrode under test. In this case the instrument measured 12.99Ω on an electrode that has an earth resistance of 10Ω

So why is that? Let's look at the way the instrument works. Inside the clamp head there are actually 2 cores, not 1.

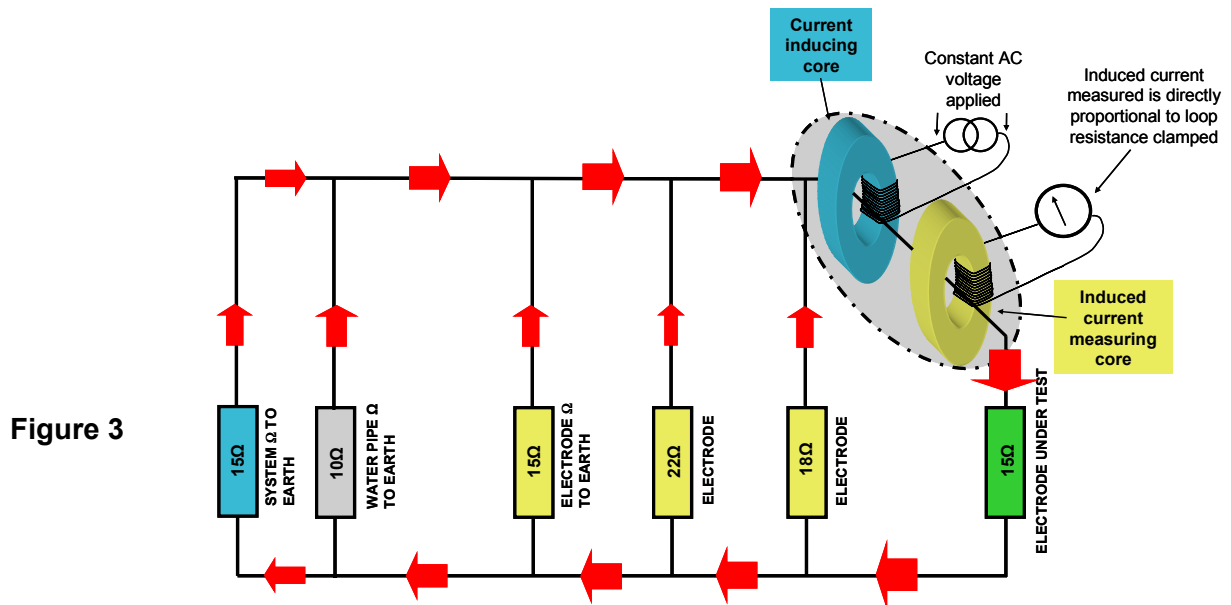

Figure 3 shows the basic operation of the two clamps inside the DET14C and DET24C head.

One core induces a test current and the other measures how much was induced. The input or primary voltage of the test current inducing core is kept constant, so the current actually induced into the test circuit is directly proportional to the loop resistance.

The important thing to remember is that the DET earth clamps effectively **make loop resistance measurements. Stake-less measurements are loop measurements.**

That leads us nicely to the **two key rules** when using a **stake-less** tester:

- 1. There must be a loop resistance to measure.**
 - i. There must be a series-parallel resistance path, and the lower the better! The more electrodes or earth paths in the system the nearer the measurement gets to the actual electrode under test true earth resistance.
 - ii. If there isn't a loop to measure you could create one with a temporary jumper lead.
- 2. The earth path must be in the circuit to measure earth resistance.**
 - i. Sounds obvious, but if you have metal structures involved there may be a connection through that, rather than the earth mass.
 - ii. Of course you may want to verify a connection, that's fine, but be sure you are testing what you think you are testing.

The greater the number of parallel paths, the closer the measured value will be to the actual earth resistance of the electrode under test. Figure 4 demonstrates this.

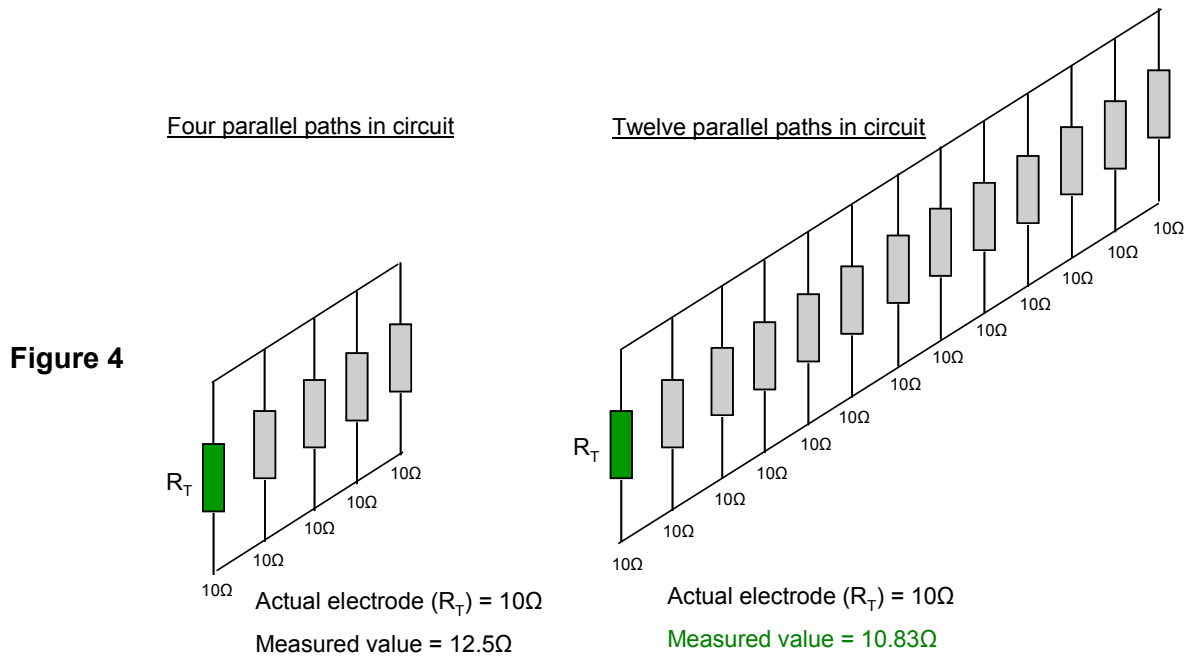

In addition the stake-less tester can easily identify a poor electrode in multiple earth path testing scenarios. See Figure 5:

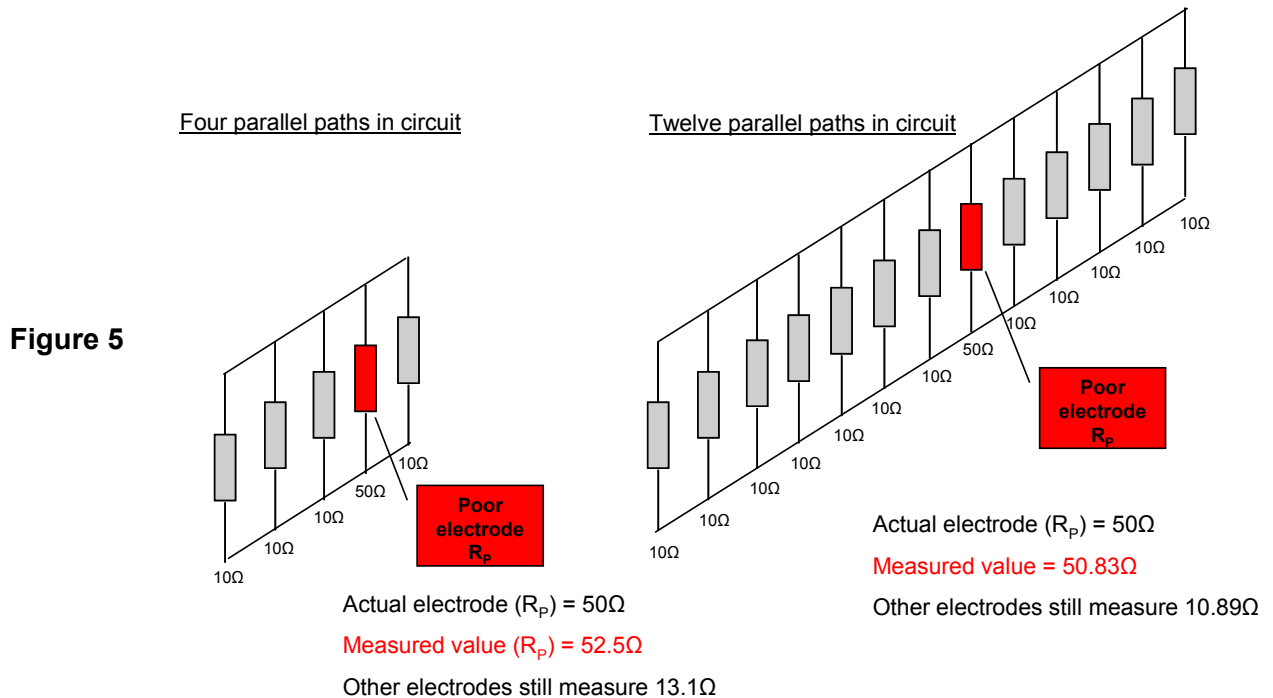

The stake-less tester can easily indicate a poor electrode whether there are a few parallel paths in series with the measured value, or many parallel paths present.

Where and how can it be used?

There are many applications for the DET14C and DET24C stake-less earth testers. Here are some examples. (All examples are intended to be representative, for example in some countries bonding a metal water pipe to the electrode system is prohibited):

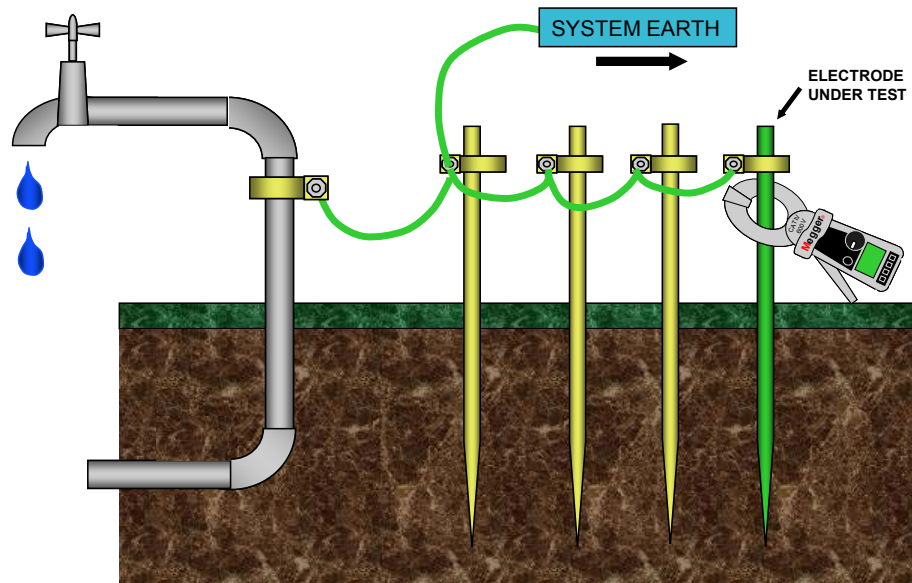

**Figure 6 –
general
earth system**

Figure 6 will look familiar from a previous page, and it describes a typical application. The system earth could be a building supply earth connection or an earth connection protecting equipment from static charges.

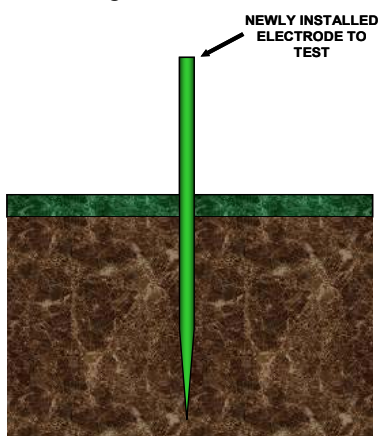

So let's start with a common question- "Can a single newly installed electrode be tested?" The first golden rule says – **"There must be a loop resistance to measure"**, so the answer is usually given as no.

However there is nothing stopping the user connecting a temporary link to a known good earth to create a loop. What we do not know is how much of the resistance belongs to which earth? But if the requirement is for the electrode resistance is to be below 25Ω, and the measured value is, then we must be within our limit. There is a word of warning though, as with using the two pole method, if the electrode and earth connection are too close they could be within each other sphere of influence.

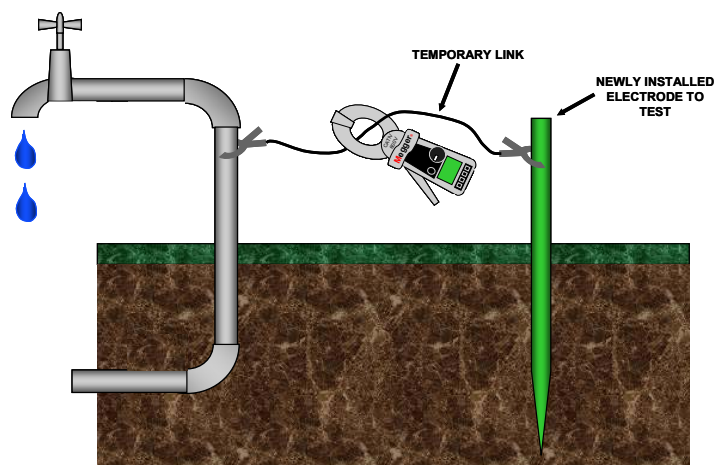

Remember the more parallel earths in series with the electrode under test, the nearer the measurement will be to the actual earth resistance value. Figure 7 shows an ideal application for the stakeless method.

Figure 7 – pole mounted transformer

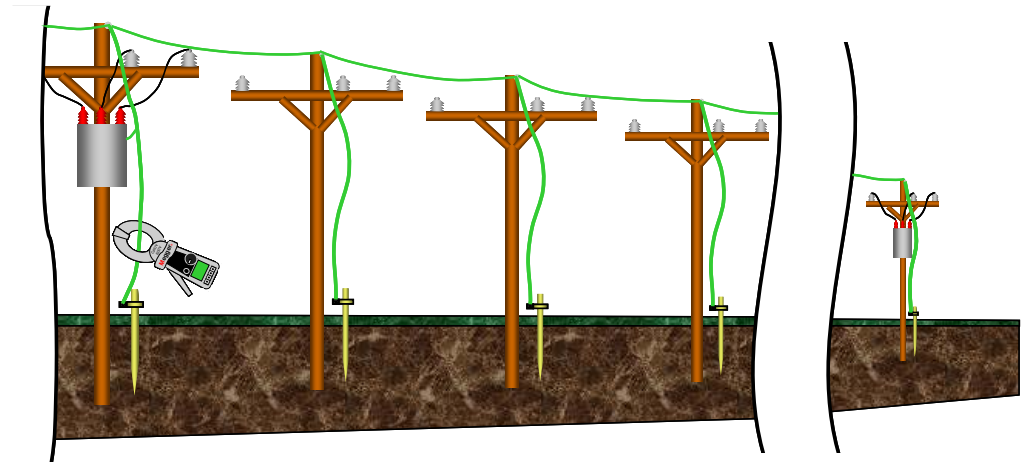

The earth / ground systems on **utility poles** and **pole mounted distribution transformers** will have many parallel earth / ground connections making this an ideal location for using the stake-less method. Each pole has an electrode to maintain fault and lightning protection, and pole mounted transformers will have two electrodes on star configured systems.

It is important that these electrodes are checked. The overall earth value of such systems typically needs to be less than 0.3 – 0.5 Ω , while each electrode typically needs to be below 10 – 20 Ω to be effective.

Another related application is to test the electrode resistance on a **service entrance or meter** (see figure 8). Here, there is the possibility of multiple earth paths, two electrodes, or maybe connection to a water pipe, so take care to identify the best positions to make a measurement. Sometimes it is best to clamp the electrode itself below where the earth connections are made.

Figure 8 – Service entrance or meter

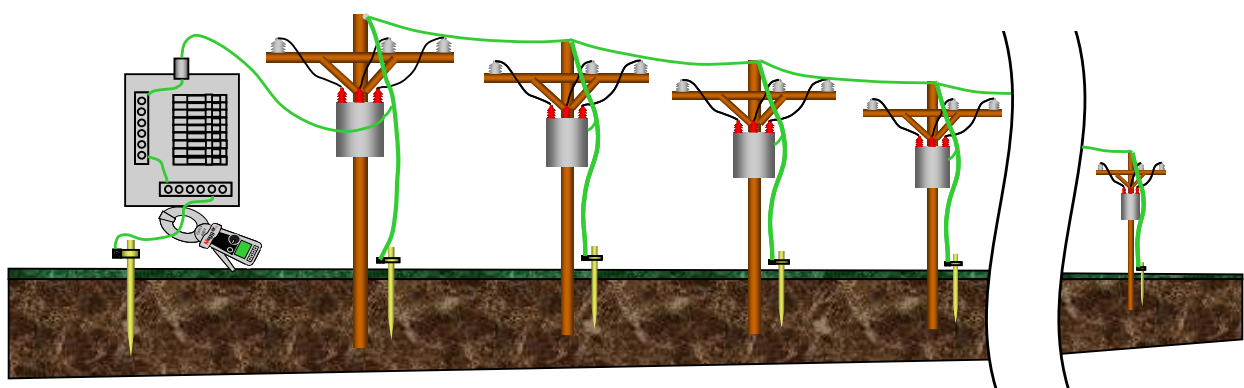

Remember the first of the two golden rules of stakeless testing, “there must be a loop resistance to measure”. There are some occasions with utility poles where that loop does not exist, well not where you want it to be anyway. In figure 9 below you can see a system with a star – delta transformer mounted on a pole with two sets of electrodes.

Neither set of electrodes are connected to an overhead earth cable, one is connected to the metal case of the transformer, and the other is connected to the star point of the LV secondary winding. The danger here is that the loop measured could be between the two sets of electrodes, with part of the loop being the resistance of the wood pole, the result being a high measurement. This could mislead the user to believe there is a problem when in fact there isn't.

Figure 9 – Pole mounted transformer

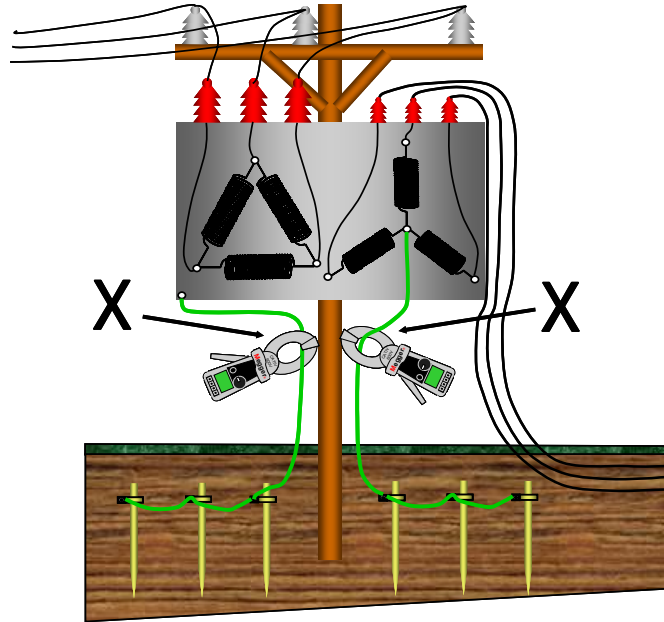

A similar application to utility pole electrodes is street lighting. The cable running to each street lights electrode may be clamped, but remember to clamp the correct side of the earthing conductor as shown in Figure 10 below.

Figure 10 – Street lighting

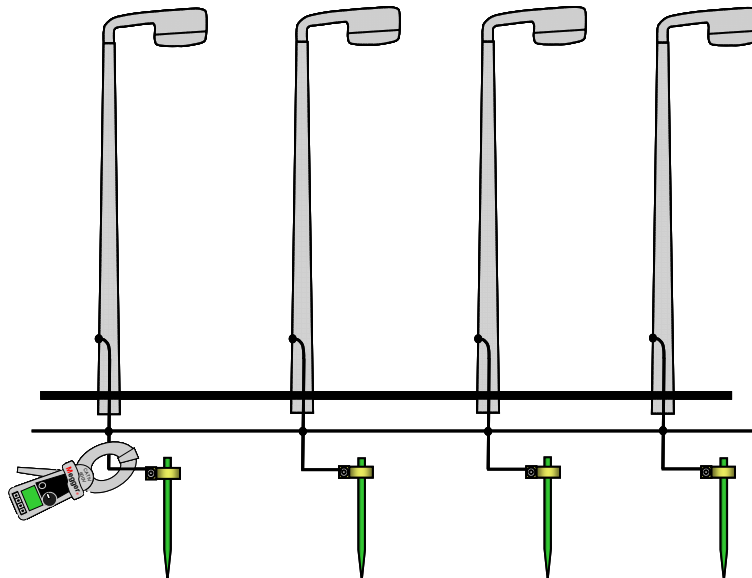

An ideal application for the stake-less test method is to test the earth / ground electrodes on **lightning protection**. Lightning protection on any building is only as effective as the quality of its grounding.

Electrodes are normally placed at each corner on a building with extra electrodes in between on larger buildings. The conductors used are typically copper tapes up to 50 mm wide. Figure 8 shows a typical lightning protection circuit.

Figure 11 – building lightning protection

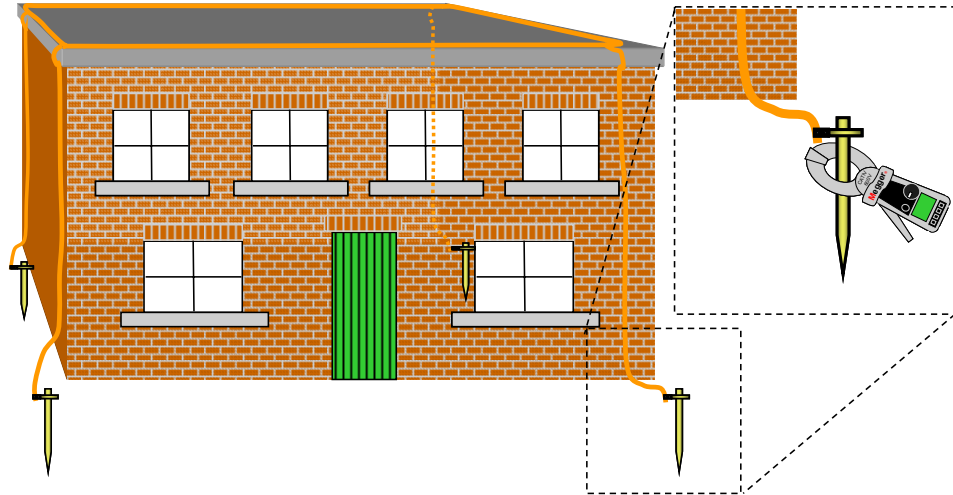

In **Figure 11** the DET14C is shown clamped around the electrode. In many cases this is difficult because the electrode is buried in a small pit. In addition many lightning protection down tapes are fitted with removable links to allow the application of a two wire continuity test. These removable links, often referred to as 'jug handles', are time consuming to remove, but make ideal locations to use a stake-less clamp tester. The clamp tester will measure the whole loop, including all of the connections and tape bonds, just the same as a two wire test.

However, it might be worth noting that due to a difference in test frequency the readings may not be exactly the same especially on tall buildings. Both methods are though a valid test method in these applications.



Removable link



Two pole test



Stake less test performed with ease



Another, perhaps unexpected, advantage with Stake less testing over the two pole method when testing lightning protection is one of hygiene. Many links are quite low and in locations that accumulate waste and debris, and may have even been urinated upon.

Many **lightning protection systems** on factory buildings, especially in European countries use lightning receptors mounted at regular intervals on the roof. These receptors are all interconnected as shown in Figure 12. This further decreases the series resistance of the parallel earth path, meaning the measured value is even closer to the true earth resistance of an electrode under test.

**Figure 12 –
factory
lightning
protection**

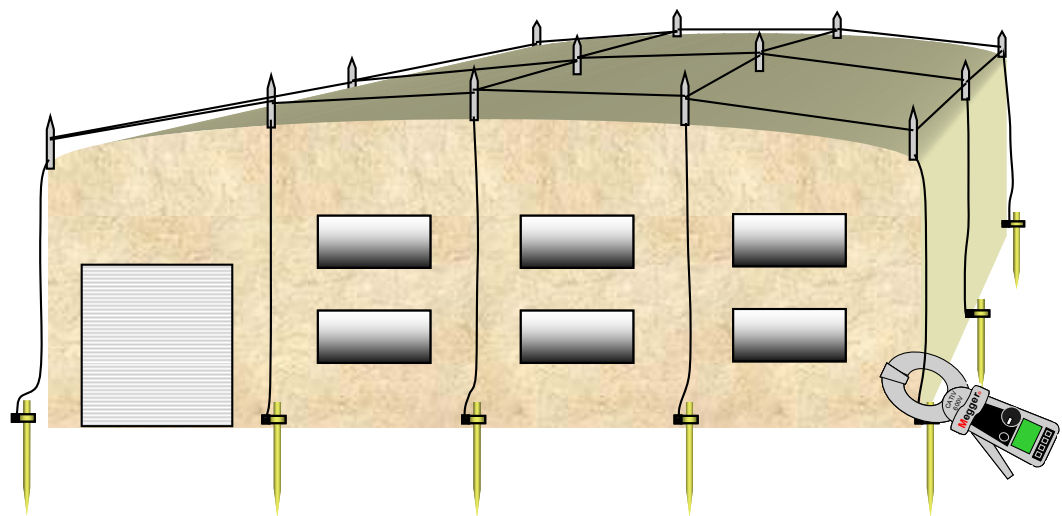

Some hints and tips when testing lightning protection

Remember there could be other connections to the lightning protection system. The user must remember to clamp around the tape below all connections, otherwise the electrode will be tested in parallel to any other paths to earth

In this case there is a connection to building electrical supply earth, but is fairly easy to identify and test below it. It will not always be so obvious though.

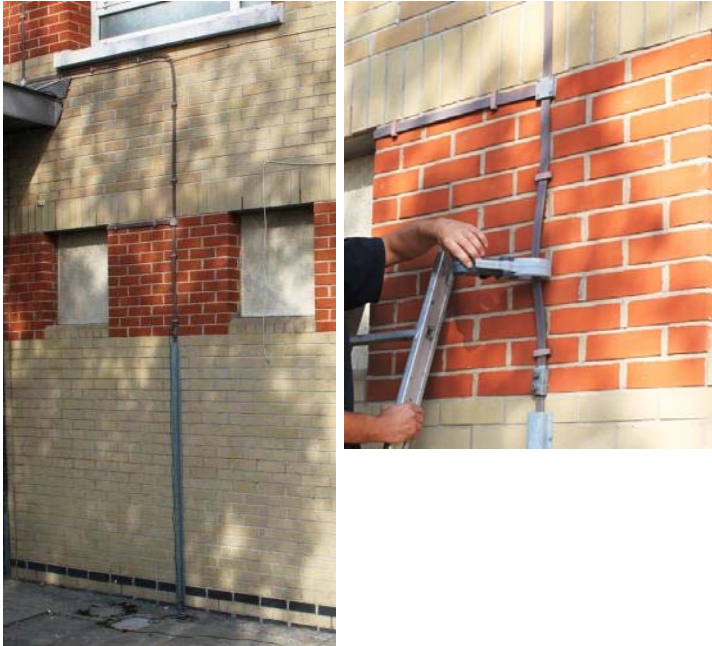

In this case there is a connection to a fire dry riser system



Remember there are connections to external metal work such as metal balconies and hand rails. These must also be above the where the stake less tester is clamped, and there are other considerations. See pictures below:

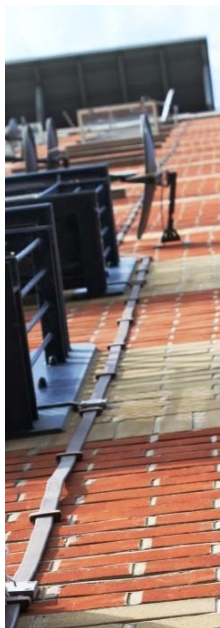

Please also remember the importance of a visual inspection. This cut and stolen tape is easy to see



But here the tape has been stolen above the balcony and it's interconnection mean both tapes at base return a good measurement

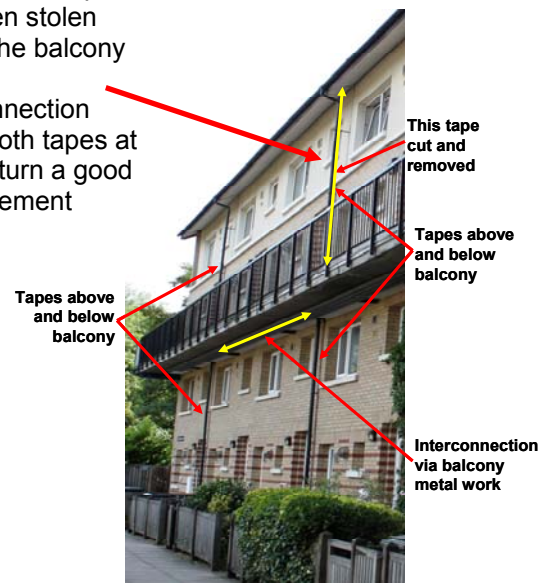

Another application is to test the earth ground electrode installed inside **primary cross-connection points**, sometime called **street cabinet/flexibility points** (Figure13). These electrodes typically need to be below 25Ω to maintain reliability. In this application there may not be more than two parallel earth paths in series with the electrode. However the stake-less method provides a measurement below 25Ω , then the electrode must certainly be below 25Ω .

Figure 13 – Street cabinet

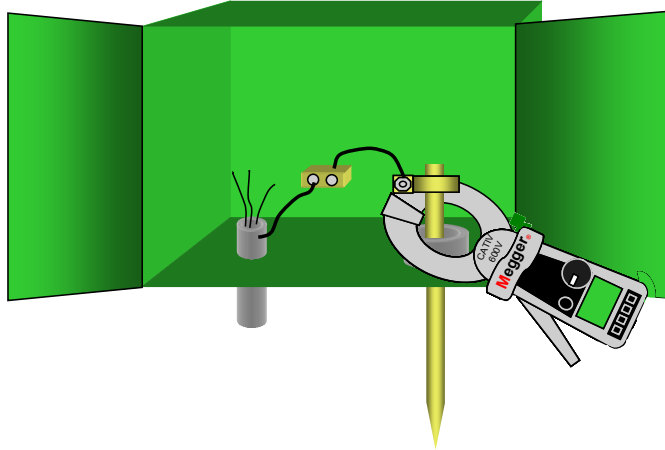

A very similar application is cable TV street cabinets

Figure 14 shows the stake-less test being used at a **remote switching site**. This application is not for testing earth resistance, but is being used to verify earth connections. By noting these test results and trending over time it is possible to identify the onset of problems such as corrosion.

Figure 14 – remote switching site

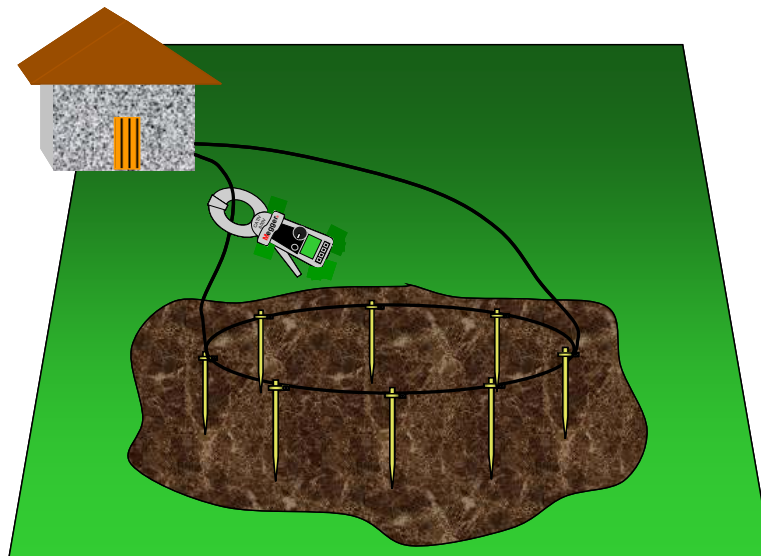

Cellular sites/microwave and radio towers are another good application. **Figure 15** shows a typical four legged tower. Each leg has been individually grounded and connected to a buried copper ring. As with the remote switching office, this test is used to verify an electrical connection, and is not a true earth / ground resistance method.

Figure 15 - Cellular sites/microwave and radio tower

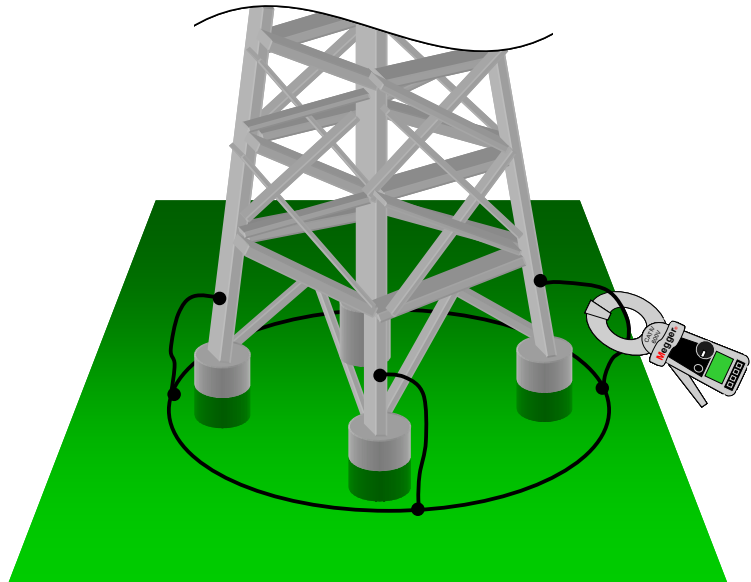

Telephone pedestal electrodes may be tested using the stake-less method. Cable sheaths are all connected to a ground bar, which in turn is connected to earth electrode. The DET clamp can be placed around the cable connecting the ground bar to the electrode to perform a test. If access is difficult a temporary extension cable can be fitted to facilitate fitting on the DET clamp.

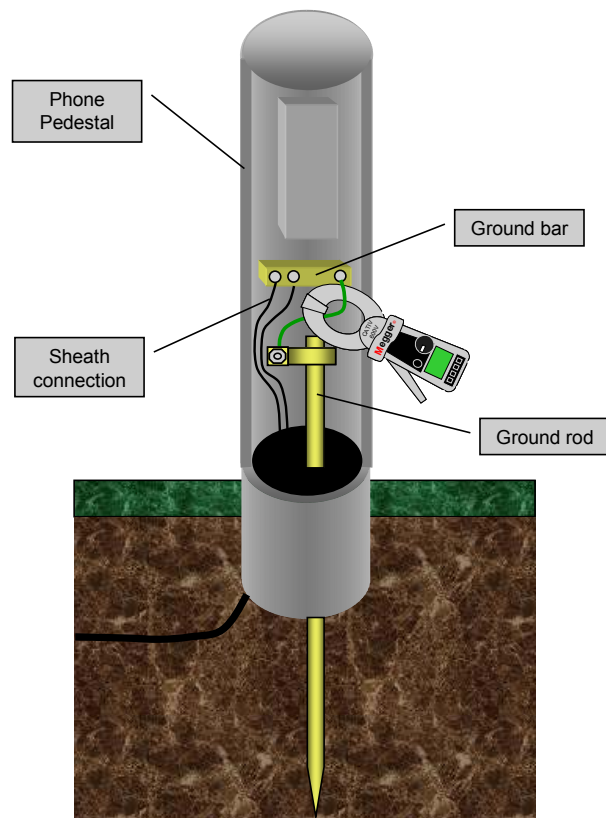

Figure 16 - Telephone pedestal



Switchyard and substation earths are another good application for stake less testing. The method is ideal for checking connections to earth mats. The only problem can be interference from induced ground current.

Substation / switchyard metal fencing connections to earth mats can be easily checked for continuity using the stake less method.



There are many applications for the stake-less method, too many to cover in a short application note but this application would be very useful to transformer test engineers. **Pad-mounted transformer** earth / grounds can be verified using the DET clamp. However sometimes there are a number of connections to the same electrode so you may have to clamp around the electrode itself below the connections. Should all these connections be to a large earth mat these measurements would then become a continuity measurement because the test loop will not include an earth path.

Figure 17 – Pad mounted transformers

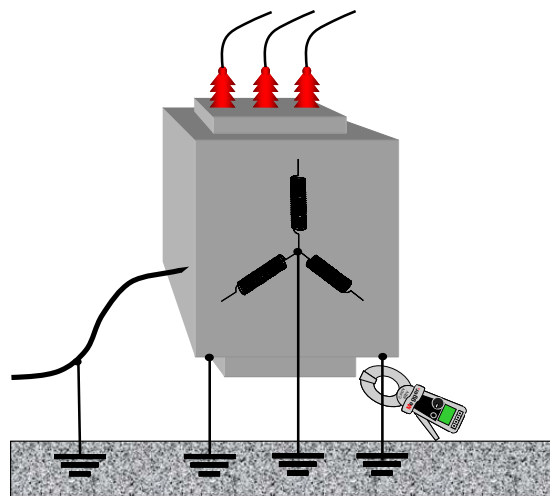

What are the potential sources of error?

If used correctly, the stake-less test will give reliable measurements as long as you use a good quality instrument. To highlight and forewarn users here are some potential sources of error:

- **The user might not understand the circuit under test. Remember the two rules of stake-less testing:**
 1. There must be a loop resistance to measure.
 2. The earth path must be in the circuit to measure earth resistance.
 - Unless of course you want to verify a connection
 - Don't forget situations like in figure 9 – Pole mounted transformers

- **Dirt trapped in the clamp head.**
 - Dirt trapped between the closing gap in the head will modify the magnetic circuit. Magnetic flux will bleed over between the inducing core and the measuring core. The result will be a false low reading which in some cases could result in a poor electrode being measured as being good.
 - Many instruments use interlocking laminations or teeth as they are sometimes referred to. These can trap the dirt and are difficult to clean, they are also easily damaged. Damaged teeth will either result in poor inaccurate measurements, or render the instrument useless.
 - The new DET14C and DET24C have easy to clean and reliable smooth mating jaw surfaces.

- **Noise current affecting measurement.**
 - Testing in noisy environments can result in high levels of noise current flowing down the electrode under test. This can cause reading to vary making them difficult to read, or if the current is too high make measurement impossible. The DET14C and DET24C have the highest resistance to noise current.

What are the benefits of stake-less earth resistance testing?

- You can test without disconnecting the electrode from the system
 - Less time consuming
 - Safety – testing can be dangerous if earth current is flowing
- Loop testing includes bonding and grounding connections
 - Identifies poor continuity anywhere in circuit
- No need to drive auxiliary test spikes to test
 - Lets you test in locations with concrete or hard ground
 - Less time consuming than running out test leads
- Can be used to measure earth current as it is a clamp meter
 - If an electrode has to be disconnected, the instrument will show whether current is flowing to indicate whether it is safe to proceed.

It is important to remember the two key rules mentioned on page 3. The stake-less measurement will rarely be the same as that obtained with a 3 pole measurement as the test is technically a loop resistance measurement. In applications with only one or a small number of return earth paths the measurement may be higher than the expected electrode resistance limit. In this case the stake-less method is still often an invaluable tool to identify changes over time.

What are the benefits of the DET14C and DET24C?

The new Megger digital earth clamp-on tester has a number of important user benefits:

- **Elliptical clamp shape design, slim in profile**
 - Enables access to earth straps / electrodes in pits
- **Large clamp capacity**
 - clamps tapes up to 50 mm wide, and clamps electrodes / cable up to 37 mm diameter (max. jaw inner dimensions 39 mm x 55 mm)
- **Low maintenance flat jaw interface**
 - No interlocking teeth to bend
- **CATIV 600V Safety**
 - The highest currently available
- **Auto-current measurement safety feature**
 - Warns if current exceeds user set limit
- **Ultra long battery life using readily available batteries**
- **Time and date stamped stored test results**
- **Pre-hold function**
- **Backlit display for low light environments**
- **Automatic noise filter function**
 - Smoothes out effect of noise current in electrically noisy environments such as substations.

The most common reason for users not being able to use the stake-less method is poor access. Often cable or tape sizes are too large for the clamp. Until now 50 mm wide earth tapes could not be tested. Many users would cut the tape and weld in a round cable to make their earth clamp testers usable. This time consuming procedure is not required with the Megger DET14C and DET24C clamps as they are equipped with an elliptical head capable of clamping 50 mm tapes with ease.

Most clamps to test 50mm tape are either:

Too small

or require modifications.....

but not with the new Megger clamps

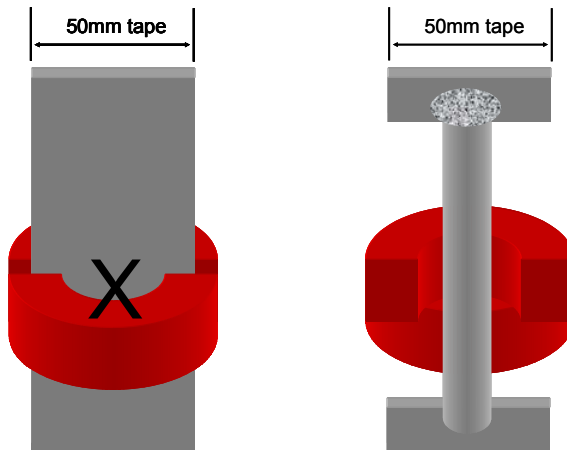

The elliptical head design of the DET14C and DET24C mean better access in electrode pits, allowing the instrument to be used at an angle to the conductor being clamped.

For more information on the new DET14C and DET24C clamps go to www.megger.com where you can get a full technical data sheet.