

LABELWORKS PX LW-PX900

User's Guide Ver.04



Read this document carefully to use this product safely and correctly. If your product is faulty, please read the included warranty card and contact the store you purchased it from. If you require further assistance, contact your local K-Sun customer support center.

Please also visit us at <http://labelworks.epson.com> for help and support. You can download the latest version of this User's Guide from the website.

Portions of this software are copyright 2016 The FreeType Project (www.freetype.org). All rights reserved.

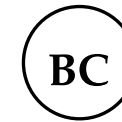

Content menu

[Safety Instructions](#)

[Specifications](#)

[Troubleshooting](#)

[Part Names and Functions](#)

[Start Here](#)

[Cleaning](#)





[Initializing the Settings](#)

[Purpose-based Index](#)

[Key Menu Index](#)



[Frame and Table Lists](#)

Notation used in this manual



 WARNING	Indicates information that, if ignored, could possibly result in serious personal injury or even death due to incorrect handling.
 CAUTION	Indicates information that, if ignored, could possibly result in personal injury, physical damage, or damage to equipment due to incorrect handling.
Attention	Indicates important information about LW-PX900.
MEMO	Indicates additional information and points which may be useful to know regarding a topic.
	Indicates a place with more detailed information.
	Shows an image of the label to be used as an example.
	Indicates the buttons on LW-PX900.
"Name"	Indicates the menu items, messages shown on the display, or the name of a manual. Example: "On", "Start print?"

Safety Instructions

For your safety, read the attached documents carefully to use this product correctly. After you have read all instructions, keep this manual handy for future reference and to make your concerns clear. Items below indicate safety precautions to protect users, their surroundings and their property from possible injury or damage. Precautionary notations are categorised as follows according to personal injury and damage to the equipment if the instructions are ignored or the equipment is misused.

 DANGER
This symbol indicates information that, if ignored, could possibly result in serious or fatal personal injury. Take extra caution in performing procedures with DANGER headings.
 WARNING
This symbol indicates information that, if ignored, could possibly result in serious personal injury or even death due to incorrect handling.
 CAUTION
This symbol indicates information that, if ignored, could possibly result in personal injury, physical damage, or damage to equipment due to incorrect handling.

The following describes the meaning of each symbol used in the precautions.

 This indicates an important reminder.
 This indicates a prohibited item.
 This indicates a mandatory procedure.





DANGER

When handling batteries

	If any liquid from the battery gets into your eyes, promptly wash it out with clean water for more than 10 minutes and consult your doctor at once. If you do not, the liquid may cause loss of eyesight. Never disassemble or modify the battery pack. This may cause fire, explosion, leakage, overheating or damage. Do not expose the battery to fire or heat it. This may cause fire, explosion, leakage, overheating or damage.
---	---

WARNING

When using the AC adapter and power cable

	The cords included with this product contain chemicals, including lead, known to the State of California to cause birth defects or other reproductive harm. Wash hands after handling. (This notice is provided in accordance with Proposition 65 in Cal. Health & Safety Code §25249.5 and following.)
	Do not use any AC adapter or power cable other than the dedicated AC adapter and power cable. Do not use the AC adapter with other than the specified voltage also. Otherwise, damage, overheating, fire or electric shock may occur.
	Take the following precautions when handling the AC adapter and power cable. <ul style="list-style-type: none"> • Make sure to avoid octopus wiring. • Make sure the plug is not dusty before inserting it into an outlet. • Insert the plug firmly into the outlet. • Do not hold the AC adapter or the plug with wet hands. • Do not pull the power cable when disconnecting the plug. Be sure to hold the plug when disconnecting it. • Do not make any modification to the AC adapter or power cable. • Do not apply strong shocks to or put a heavy object on the AC adapter or power cable. • Do not bend or twist the AC adapter or power cable forcibly. • Do not place the AC adapter or power cable near a heater.
	Do not use any damaged AC adapter or power cable. Otherwise, damage, overheating or smoking may occur, which may result in fire or electric shock.
	Do not touch the plug during thunderstorms.

Top

Safety Instructions

Specifications

Troubleshooting

Part Names and Functions

Start Here

Cleaning

Initializing the Settings

Purpose-based Index

Key Menu Index

Frame and Table Lists

When handling batteries

⚠	Keep the battery pack away from fire or flame if it produces a strange odor or leakage. Otherwise fire or explosion may occur.
⚠	Should any battery liquid get on skin or clothing, promptly wash it off with clean water. If you do not, the liquid may damage your skin.
⚠	Do not expose the battery to water. Do not allow water to contact the terminals. This may cause fire, overheating, or electric shock.
⚠	Keep batteries out of reach of children. They are extremely dangerous if swallowed. Contact a doctor immediately if swallowed.

When using this product

⊘	Do not apply any strong force or shocks to the product such as standing on, dropping or hitting it. Otherwise, the product may be broken, which may result in fire or electric shock. If it is damaged, turn off the power immediately, unplug the AC adapter and remove the batteries, and then contact the K-Sun customer support center. Continuous use may result in fire or electric shock.
⚠	Take care not to spill any beverage such as tea, coffee or juice onto the product, or to spray aerosol insecticide. It may cause malfunction, fire, or electric shock. If any liquid has been spilled on the product, turn off the power, unplug the AC adapter and remove the batteries immediately, and then contact the K-Sun customer support center. Continuous use may result in fire or electric shock.
⚠	Do not touch the printhead because it becomes very hot. Otherwise, there is a risk of burns.
⊘	Do not open any covers other than the top cover or battery cover. Doing so may result in fire or electric shock. Always use the product as instructed in this manual. Otherwise, damage or injury may occur.
⊘	Never modify or disassemble this product. Doing so may cause fire or electric shock. Do not carry out any operations not described in this manual, or the product may break or cause injury.
⚠	If any of the following abnormalities is observed, turn off the power immediately, unplug the AC adapter and remove the batteries, and then contact the K-Sun customer support center. <ul style="list-style-type: none"> • If smoke, strange odors or unexpected noises come from the product • If liquid or foreign objects get inside the product • If the product has been dropped or damaged
⚠	Do not touch the tape eject slot, during printing or when the auto cutter is in operation. Otherwise there is a risk of injury.

Others

⊘	Do not use or store the product, batteries, AC adapter, power cable, or tape cartridges in the following places. <ul style="list-style-type: none"> • In direct sunlight. • Where it may become extremely hot such as in a vehicle with the windows closed. • Where it may become extremely hot such as near a heater or the temperature becomes very unstable such as near the exhaust duct of an air conditioner. • Where the product may get wet due to a shower or rain such as in a bathroom or outdoors. • In a dusty place or where the product may be exposed to smoke or steam such as near the kitchen or a humidifier. • On an unstable place such as on a shaky table or on an inclined place. • Where it might be subjected to vibration or shock. • Near high-voltage power lines or something that generates a magnetic field.
⚠	Keep the plastic bags used to contain the product or this manual out of reach of children. Children may suffocate if they swallow them or put their heads into the bags.

⚠ CAUTION

When handling batteries

⚠	If liquid leaks from a battery, wipe it off with a cloth and replace it with a new one. If the liquid comes in contact with your skin, wash it away with water immediately.
⊘	If the batteries are used incorrectly, they may cause leakage, overheating, explosion, erosion, or damage to the product, which may result in fire or injury. <ul style="list-style-type: none"> • Do not use new ones and old batteries together, or mix different types of batteries. • Use AA alkaline batteries. • Use batteries in the correct directions. • Take the batteries out immediately when they have no power remaining. • Take the batteries out if you do not use the product for a long time. • Do not heat batteries or throw them in fire or water. • Do not pinch the batteries with metal tweezers or use any pointed sharp metal object such as the tip of a mechanical pen or ball-point pen when taking the batteries out.
⚠	When disposing of used batteries, make sure to follow the regulations.

Top

Safety Instructions

Specifications

Troubleshooting

Part Names and Functions

Start Here

Cleaning



Initializing the Settings

Purpose-based Index





Key Menu Index

Frame and Table Lists



When using the AC adapter

	Do not unplug the AC adapter while the product is in operation, otherwise printing may not be successful.
	Do not use the AC adapter in a small, confined space, or cover it with a cloth. Otherwise, the AC adapter may overheat and deteriorate.

When using this product

	Do not stand or put anything heavy on the product or place it on an unstable place such as on a shaky table or on an incline. Otherwise, the product may fall and cause injury.
	To ensure safety, unplug this product before leaving it unused.
	Before cleaning, make sure to unplug the AC adapter from the outlet, and remove the batteries.
	Do not use a moistened cloth or solvents such as alcohol, thinner or benzene.
	Do not block or insert objects into the supplied AC adapter socket or the tape eject slot.

■ When handling tape cartridges

- Make sure to use a dedicated  PX Tape.
- Some types of tape cannot be cut by the cutter. For the details, refer to the tape's manual.
- Do not drop it or disassemble it. Doing so may cause damage.
- Do not pull out the tape forcibly by hand. But make sure to feed the tape with . Otherwise, the tape cartridge may be broken and unusable.
- Avoid using a tape cartridge without remaining tape. Doing so may cause overheating of the printhead, which may result in damage or malfunction.

MEMO

Tape cartridges contain ink ribbons in them. When disposing of tape cartridges, make sure to follow the local regulations for disposal.

■ Other cautions

Notes on usage

- Do not touch the thermal head. Static electricity may damage the thermal head.
- Do not plug in and unplug the AC adapter while printing. Power may be cut off.
- The Li-ion battery cannot be charged while printing.
- Operate the keyboard gently.
- Take care not to cut your fingers when cutting the label with scissors.
- Do not attach a label on human bodies, living things, public facilities or other people's belongings.
- Be sure to turn the power off after use.
- Powering off message is displayed while turning off the product. Do not remove the AC adapter until the message disappears.
- Be sure to replace batteries with the power turned off. If you replace the batteries while the product is powered, files or data stored on it may be deleted.

■ Recycling the Battery

Contains a lithium-ion battery. Must be recycled or disposed of properly.

MEMO

Do not disassemble the battery pack.



For American Users

The lithium-ion battery is recyclable. At the end of its useful life, under various state and local laws, it is illegal to dispose of this battery into your municipal waste stream. Please call 1-800-8-BATTERY for information on how to recycle this battery.

Top

Safety Instructions

Specifications

Troubleshooting

Part Names and Functions

Start Here

Cleaning

Initializing the Settings

Purpose-based Index

Key Menu Index

Frame and Table Lists

Specifications

Body

Dimensions	Approx. 136 (W) x 295 (D) x 97 (H) (mm)
Weight	Approx. 1,250 g (excluding batteries, tape cartridge)

Usage conditions

Operating temperature	5 to 35 degrees C
Storage temperature	-10 to 55 degrees C

Supported tape width

4 mm, 6 mm, 9 mm, 12 mm, 18 mm, 24 mm, 36 mm
--

Power supply

Battery

Li-ion battery x 1 / AA alkaline battery x 6
--

AC adapter

Type	AST1527Z2-1
Manufacturer	Seiko Epson Corp.
Input	AC100-240V, 1.2 A, 50-60Hz (dedicated adapter, power cable only)
Output	DC15V, 2.7A
Total output power	40.5 W

Li-ion battery specifications

Ambient temperature

During operation	0 to 40 degrees C	
Charge	0 to 40 degrees C	
During storage	Less than 1 month	-20 to 50 degrees C
	Less than 3 month	-20 to 40 degrees C
	Less than 1 year	-20 to 20 degrees C

Charging information

Nominal specifications	Charging current (Std.)	1.0 A
	Charging voltage (Std.)	8.05 V
	Charging time	Approx. 3 hours
Charge limits	Battery pack model	C52CE97010
	Maximum charge current, A	1.0 A
	Maximum charge voltage, V	8.4 V

Rated time when using alkaline batteries

Rated operating time / Rated resting time	0.5h / 1.0h
---	-------------

Top

Safety Instructions

Specifications

Troubleshooting

Part Names and Functions

Start Here

Cleaning

Initializing the Settings

Purpose-based Index



Key Menu Index

Frame and Table Lists

Troubleshooting

■ Messages

This section explains the remedies when the following messages appear on the display.

Check battery Charge Li-ion!	The battery runs out of power. Connect the AC adapter to LW-PX900 and charge the battery. For details,  "Charging the Li-ion battery"
Check battery Change alkaline	The batteries run out. Turn off the power and replace all batteries with new ones.
Cover open!	Top cover is open. Close the top cover.
Insert tape	Check if the tape cartridge is loaded or correctly set. For details,  "Installing a tape cartridge"
Check tape cartridge	The loaded tape is not supported. Insert a correct cartridge.
No more sequence No.!	Only up to 2 sequence numbers can be inserted.
No more barcode!	Only up to 2 barcodes can be inserted.
QR CODE too big!	Perform either of the following: Use a wider tape. Reduce the text or cell size. Lower "ECC Level".
Overheated!	The printhead is overheated. Turn off the power and remove the tape cartridge, then leave the product until it cools down.
Trash at slot Remove trash	Tape remains in the tape eject slot. Remove the tape.
Remove cut tape	Unable to start printing because cut tape remains in the tape eject slot. Remove the tape from the tape eject slot.

■ Problem

Unable to charge Li-ion battery

Is the Li-ion battery correctly installed? Check that the Li-ion battery is correctly installed.
Is the AC adapter securely connected? Connect the AC adapter and the power cable firmly to the power socket of the product, the AC adapter connector and the outlet.

Unable to detect the tape correctly

Is the tape cartridge correctly installed? Check that the tape cartridge is correctly installed.
Is the label for detecting the tape cartridge clean? If not, wipe the dirt off with a soft cloth.
Is the detection sensor of LW-PX900 clean? If not, wipe the dirt off with a soft cloth.

MEMO

If none of the above has solved the problem or the symptom is other than the above, contact the K-Sun customer support center.

Top

Safety Instructions

Specifications

Troubleshooting

Part Names and Functions

Start Here

Cleaning

Initializing the Settings

Purpose-based Index

Key Menu Index

Frame and Table Lists

Part Names and Functions

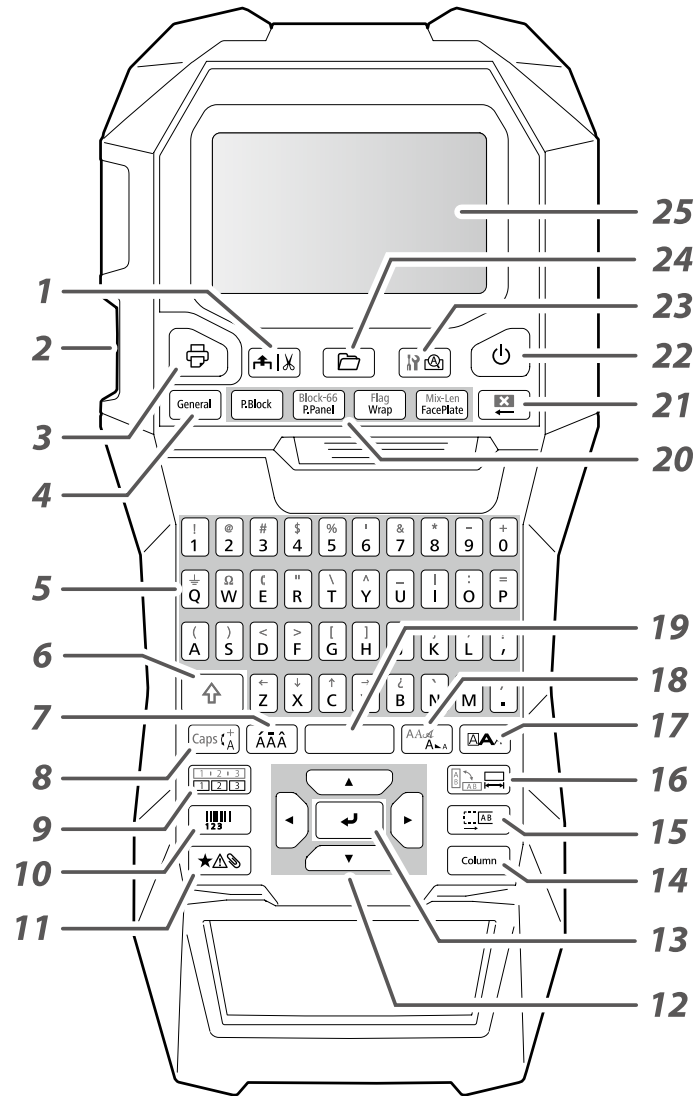

1. Feeds and then cuts the tape.
2. Tape eject slot
3. Prints a label.
 + : Prints with a special print function.
4. Creates a general label.
5. Character keys
6. Shift
7. Enters a character with an accent.
8. Changes the input method of the character keys.
 + : Caps Lock
9. Creates a label with a sequence number.
10. Creates a barcode label.
11. Enters a symbol.
12. Cursor keys
13. Confirms the settings.
14. Adds a block.
15. Sets the margins.
 + : Changes the text orientation.
16. Sets the tape length.
 + : Changes the format and style.
17. Sets the format and style.
18. Changes the font size.
 + : Changes the font type.
19. Space
20. Creates a special label.
21. Delete
22. Turns LW-PX900 on and off.
23. Previews the created label.
 + : Sets LW-PX900.
24. Saves and recalls the label.
25. Display

Top

Safety Instructions

Specifications

Troubleshooting

Part Names and Functions

Start Here

Cleaning

Initializing the Settings

Purpose-based Index

Key Menu Index

Frame and Table Lists

■ Display

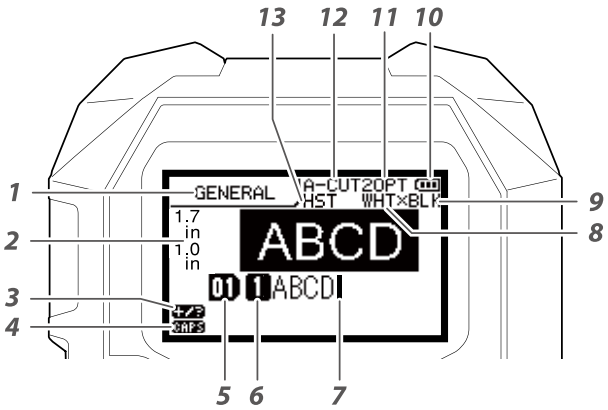

The display shows the current settings and characters you have entered. You can change the language shown on the setting screen and menu.

🔄 "Language"

1. Form name
2. Set tape width and length
The unit can be switched between inch and cm.
🔄 "inch:cm"
3. Symbol input mode
4. Caps Lock ON
5. Block number
6. Row number
7. Cursor
8. Color of text to be printed
9. Set tape color
10. Remaining battery level
11. Font size
12. Label cut method
13. Set tape type

Top

Safety Instructions

Specifications

Troubleshooting

Part Names and Functions

Start Here

Cleaning

Initializing the Settings

Purpose-based Index

Key Menu Index

Frame and Table Lists

Start Here

1. Installing the Li-ion battery

Before using the printer for the first time, charge the Li-ion battery (C52CE97010). Read also the safety precautions for the rechargeable battery described previously in this manual.

For details on the handling of Li-ion battery, see "Li-ion Battery Instruction Manual".

⚠ WARNING

Be sure to use the dedicated Li-ion battery (C52CE97010). Using a battery other than the one specified may cause fire, explosion, leakage, overheating or other damage.

⚠ CAUTION

When disposing of used batteries, make sure to follow the regulations.

1. Open the battery cover.

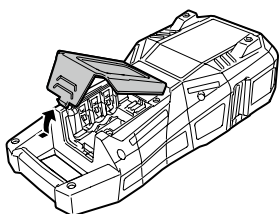

2. Install the Li-ion battery in the correct orientation.

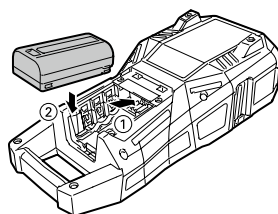

3. Close the battery cover.

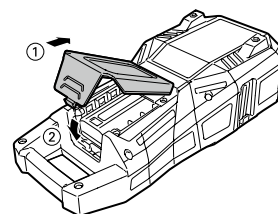

■ Charging the Li-ion battery

You can charge the dedicated Li-ion battery (C52CE97010) with LW-PX900.

To charge the battery, connect the AC adapter to LW-PX900 with the Li-ion battery installed.

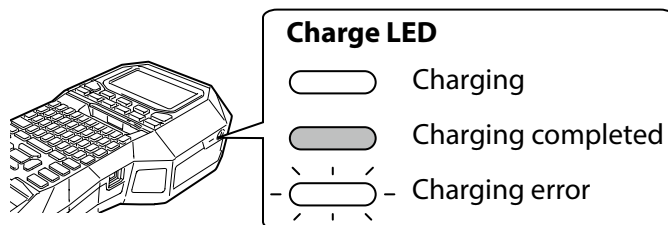

MEMO

- The Li-ion battery cannot be charged while printing.
- When the power of the charged Li-ion battery seems to run out quickly, replace it with new ones.
- There is likely to be a charging error or battery error in the following cases. Contact K-Sun customer support center.
 - The charge LED flashes during charging.
 - New Li-ion battery takes significantly longer to charge than the estimated charging time (less than 3 hours).

Top

Safety Instructions

Specifications

Troubleshooting

Part Names and Functions

Start Here

Cleaning

Initializing the Settings

Purpose-based Index

Key Menu Index

Frame and Table Lists

■ **Using alkaline batteries**

You can use alkaline batteries instead of Li-ion battery. When using alkaline batteries, install them in the correct orientation.

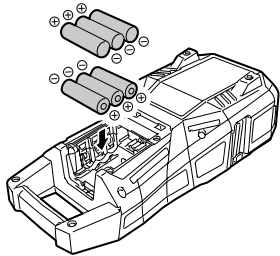

■ **Connecting the AC adapter**

Connect the AC adapter as shown below.

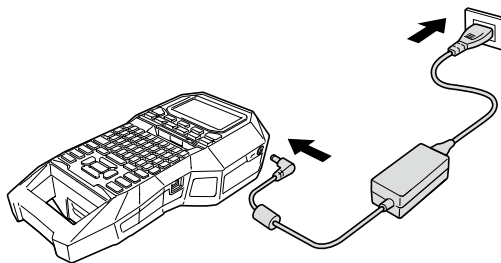

■ **Using Label Editor Professional**

Label Editor Professional is an application software for editing label.

When this software is installed on your computer, you can transfer the created cable label data to the printer. For how to install and operate the software, see "Label Editor Professional User's Guide".

1. **Connect the USB cable to LW-PX900.**
2. **Connect the other connector of the USB cable to the computer.**

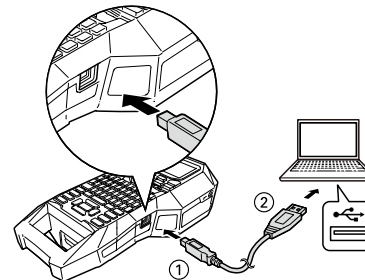

2. Installing a tape cartridge

⚠ CAUTION

- Make sure that the power is turned off.
- You cannot use tape other than PX-tape.
- Make sure the top cover is closed firmly.
- If you opened the top cover while a tape cartridge is installed, check that the tape end is put into the tape eject slot before beginning operation.
- Take care to keep the label for detecting the tape cartridge and the sensor of LW-PX900 clean. Otherwise, tape may no longer be detected correctly.
- Do not touch the sensor directly with your fingers.

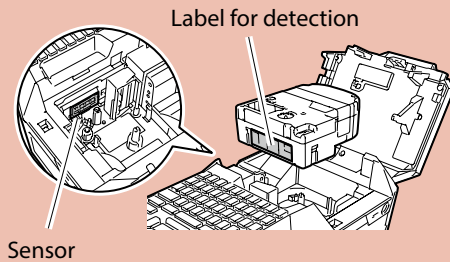

1. Rewind the ink ribbon.

Use a pen or a pencil.

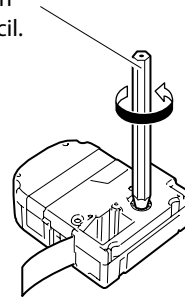

3. Install a tape cartridge.

Put the tape end into the tape eject slot.

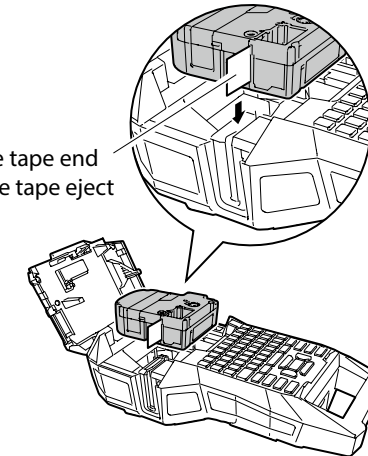

2. Open the top cover.

Top cover

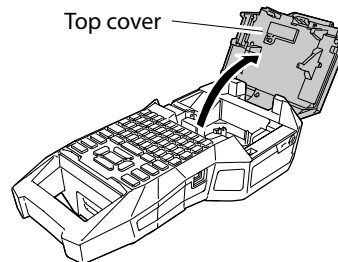

4. Close the top cover.

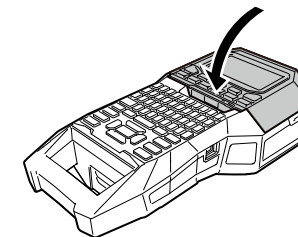

Top

Safety Instructions

Specifications

Troubleshooting

Part Names and Functions

Start Here

Cleaning

Initializing the Settings

Purpose-based Index

Key Menu Index

Frame and Table Lists

3. Turning the power on

1. Press .

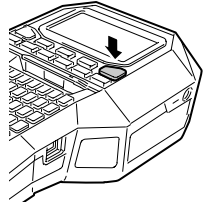

Auto power-off

If there is no key operation within five minutes, LW-PX900 automatically turns off. (The characters you have entered in the current session are stored.) Furthermore, if there is no key operation within an hour while connected to a computer, LW-PX900 automatically turns off.

■ Feeding the tape

CAUTION

Be sure to feed the tape every time after you install a tape cartridge.

1. Press .
2. Select a function with / and then press .

Tape feed

Feeds the tape.

Feed and cut

Feeds the tape and then cuts the tape.

Top

Safety Instructions

Specifications

Troubleshooting

Part Names and
Functions

Start Here

Cleaning

Initializing the
Settings

Purpose-based Index

Key Menu Index

Frame and Table Lists

4. Entering text

Ex Câble#101

1. Press + .

|

2. Press .

3. Press .

A list of characters appears.

For the accent marks that can be inserted "Accent"

a
á à â ã ä å æ ç è é
â
ã

4. Select a character with / and press .

"â" is entered.

Câ |

5. Press keys: .

" Câble" appears on the screen.

6. Press + .

"#" is entered.

7. Press keys: .

Câble#101 |

Save the created label: "Saving Frequently Used Labels"

Change the font: "Changing the Font"

Change the font size: "Changing the Font Size"

■ Deleting text

1. Press .

A character is deleted backward.

Deleting all text

1. Press + .

2. Select a function with / and then press .

Text Only

Deletes all text.

Text & Setting

Deletes all text and restores the font size and other settings to the initial settings.

All Format

Deletes all text and displays the General editing screen. Depending on the label type you create, "All Format" may not be displayed.

Top

Safety Instructions

Specifications

Troubleshooting

Part Names and Functions

Start Here

Cleaning

Initializing the Settings

Purpose-based Index

Key Menu Index

Frame and Table Lists

5. Printing label

1. Press .

Setting the label auto cut to Off

 "Auto cut"

Printing with special print functions

 "Utilizing Print Functions"

■ *Checking the print image*

1. Press .

The print image scrolls on the entire screen.
When the preview ends, the editing screen reappears.

CAUTION

- Do not insert your fingers into the tape eject slot.
- Do not pull the tape until the printing is completed.

Attention

- "Insert tape" will appear on the display if the tape cartridge is not loaded or not correctly set.
- Length of the label shown on the display is a guide and may not match the length of the printed label exactly.
- Label over 16m in length cannot be printed.

MEMO

- To cancel the printing, press .
- Depending on your margin setting or the label type, tape may be fed and cut before printing.

Top

Safety Instructions

Specifications

Troubleshooting

Part Names and Functions

Start Here

Cleaning

Initializing the Settings

Purpose-based Index

Key Menu Index

Frame and Table Lists

6. Attaching label

1. Peel off the backing paper.



2. Attach the label and rub it firmly.

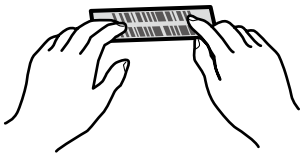

CAUTION

Depending on the environment where you use labels and the nature of the adhered surface, the labels may be peeled or discoloured, and the adhesive may remain on or damage the adhered surface. Be sure to check the environment and the nature of the adhered surface before use. K-Sun takes no responsibility for any damage or loss due to the above mentioned causes.

7. Turning the Power Off

1. Press .

The characters you have entered in the current session are stored even after LW-PX900 is turned off. They are displayed when it is turned on again.

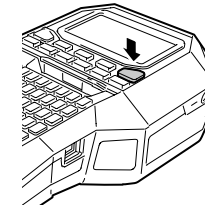

2. Open the battery cover and then remove the Li-ion battery.

If the AC adapter is connected, disconnect the AC adapter from LW-PX900.

CAUTION

- "Powering off." is displayed while turning off this product. Do not remove the Li-ion battery or disconnect the AC adapter until this message disappears.
- When you don't use the product for a long period of time, remove the batteries (Li-ion battery or alkaline batteries), disconnect the AC adapter, and remove the tape cartridge from LW-PX900.

Cleaning

CAUTION

Turn off the LW-PX900 and remove the batteries before cleaning.
If the AC adapter is connected, disconnect the AC adapter cable from LW-PX900.

Exterior

Wipe the dirt off with a soft cloth.
If it is very dirty, use a cloth damp.

CAUTION

Never use chemicals or solvents such as benzene, thinner, or alcohol, or use a chemical duster.

Printhead

Clean the printhead with a cotton swab.

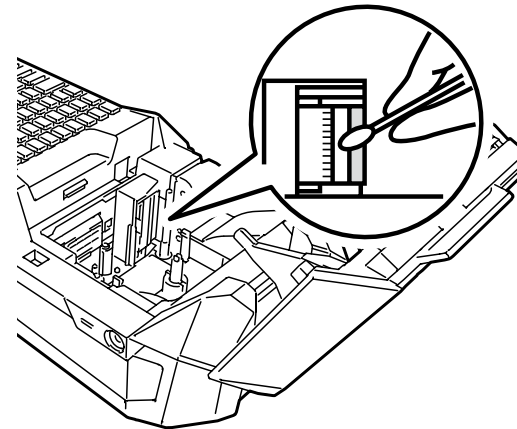

Top

Safety Instructions

Specifications

Troubleshooting

Part Names and Functions

Start Here

Cleaning

Initializing the Settings

Purpose-based Index

Key Menu Index





Frame and Table Lists

Initializing the Settings

Initialize the settings if LW-PX900 does not operate normally such as the display is interrupted.

Attention

This function initializes the settings. Take extreme care before initializing it. All the created text will be lost and the settings you made will be reset.

1. If the power is on, press  to turn it off.
2. Press and hold  + , and press .
3. When a message appears, press .
The settings will be initialized.

MEMO

To cancel initialization, press a key other than .

Top

Safety Instructions

Specifications

Troubleshooting

Part Names and Functions

Start Here

Cleaning

Initializing the Settings

Purpose-based Index

Key Menu Index

Frame and Table Lists

Purpose-based Index

Click the illustration of the label you wish to create or function you wish to use, to display information such as the creation procedure or setting procedure.

Label Types

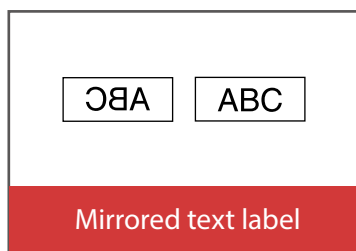
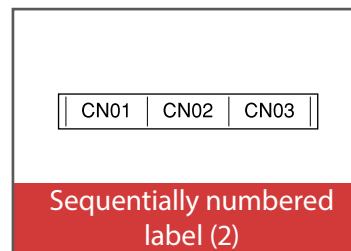
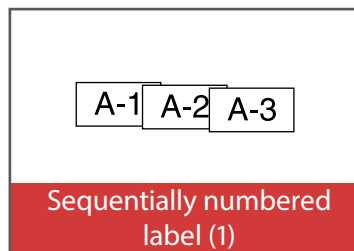
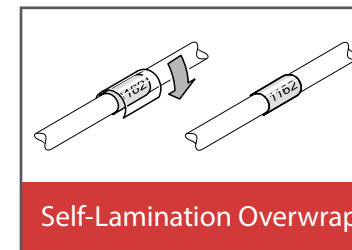
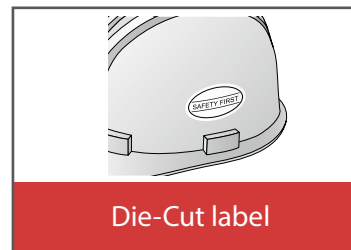
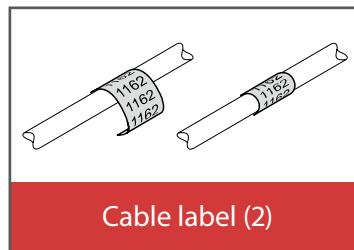
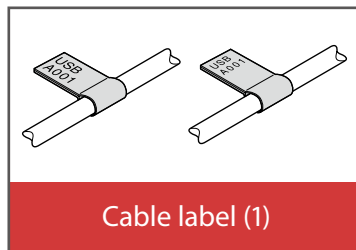
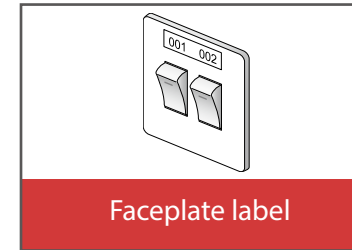
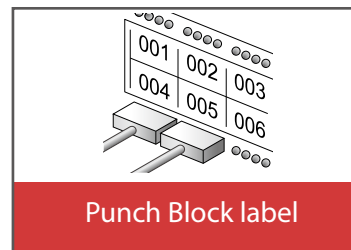
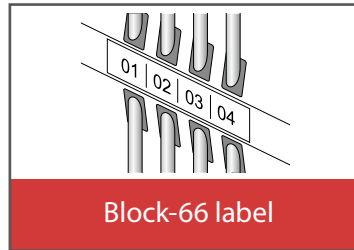
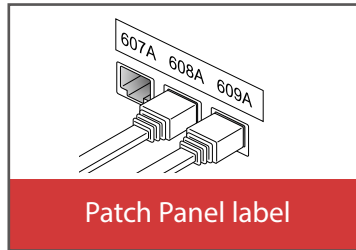

Top

Safety Instructions

Specifications

Troubleshooting

Part Names and Functions

Start Here

Cleaning

Initializing the Settings

Purpose-based Index

Key Menu Index

Frame and Table Lists

Customizing Labels

Format/Style

Font size

Font

Length

Margins

Text orientation

Adding block

Specifying the Font Size

Useful Functions

Creating Multiple Labels at Once

Swapping the Text

Saving/Recalling Frequently Used Labels

Printing Same Label Multiple Times

LW-PX900 Settings

Transferring Cable Label Data

Top

Safety Instructions

Specifications

Troubleshooting

Part Names and Functions

Start Here

Cleaning

Initializing the Settings

Purpose-based Index

Key Menu Index

Frame and Table Lists

Creating Special Labels

Creating Labels for Patch Panel Block-66 P.Panel

You can create the optimal labels for your patch panel by setting the label length and number of blocks.

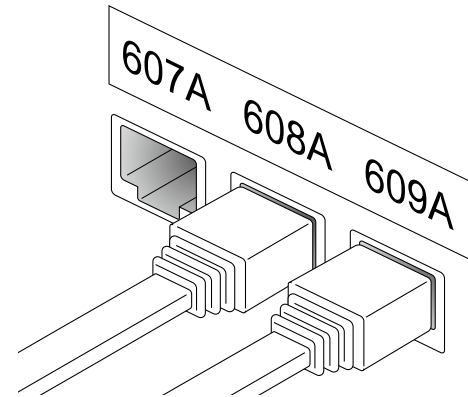
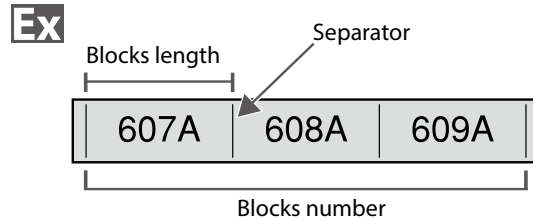

1. Press Block of Panel.
2. Select the length type with ▲/▼ and then press ↵.
In this example, we will select "Blocks".
Blocks: Sets the length by block length.
Label: Sets the length by label length.
3. Enter the blocks length and then press ↵.
Setting range: 0.25 to 30 cm
4. Enter the blocks number and then press ↵.
In this example, we will enter "3".
Setting range: 1 to 50
5. Select the type of separator with ▲/▼ and then press ↵.
In this example, we will select "Line".

6. Select the orientation with ▲/▼ and then press ↵.
In this example, we will select "Hori."
Hori.

607A	608A	609A
------	------	------

Vert.1

607A	608A	609A
------	------	------

Vert.2

607A	608A	609A
------	------	------
7. Enter the text.
You can create labels with sequence numbers.
For details, see "Creating Labels with Block Sequence Numbers Assigned"
8. Press 🖨.

Top

Safety Instructions

Specifications

Troubleshooting

Part Names and Functions

Start Here

Cleaning

Initializing the Settings

Purpose-based Index

Key Menu Index

Frame and Table Lists

Creating Labels for Block-66

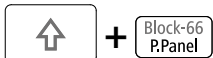

You can create labels for Block-66 so that large numbers of connectors can easily be identified.

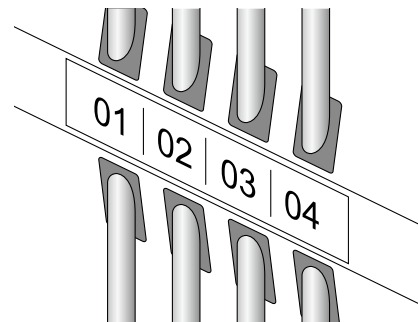
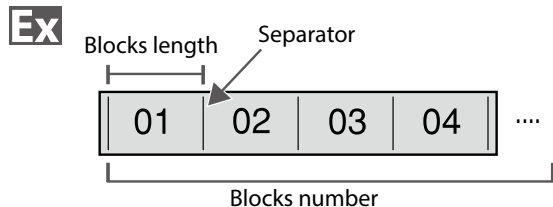

1. Press + .
2. Select the length type with / and then press .

In this example, we will select "Blocks".

Blocks: Sets the length by block length.
Label: Sets the length by label length.
3. Enter the blocks length and then press .

Setting range: 0.25 to 30 cm
4. Enter the blocks number and then press .

In this example, we will enter "4".

Setting range: 1 to 50
5. Select the type of separator with / and then press .

In this example, we will select "Line".

6. Select the orientation with / and then press .

In this example, we will select "Hori."

Hori.

Vert.1

Vert.2
7. Enter the text.

You can create labels with sequence numbers.

For details, see "Creating Labels with Block Sequence Numbers Assigned"
8. Press .

- Top
- Safety Instructions
- Specifications
- Troubleshooting
- Part Names and Functions
- Start Here
- Cleaning
- Initializing the Settings
- Purpose-based Index
- Key Menu Index
- Frame and Table Lists

Creating Labels for Faceplate

Mix-Len FacePlate

Text can be automatically placed at the center of a block. This enables you to easily create a label suitable for the size of the area where it will be affixed.

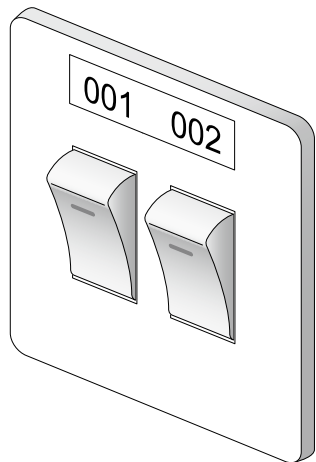
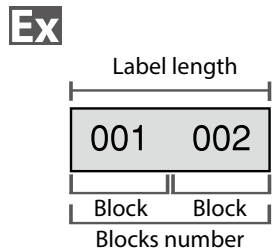

1. Press .
2. Enter the label length and then press .
Setting range: 1 to 99.9 cm
3. Enter the blocks number and then press .
In this example, we will enter "2".
Setting range: 1 to 50

4. Select the orientation with / and then press .

In this example, we will select "Hori.".

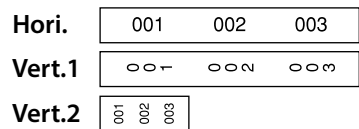

5. Enter the text.
6. Press .

Top

Safety Instructions

Specifications

Troubleshooting

Part Names and Functions

Start Here

Cleaning

Initializing the Settings

Purpose-based Index

Key Menu Index

Frame and Table Lists

Creating Labels for Punch Block P.Block

You can create labels to identify at a glance the numbers for the wires or pins connected to a punch block.

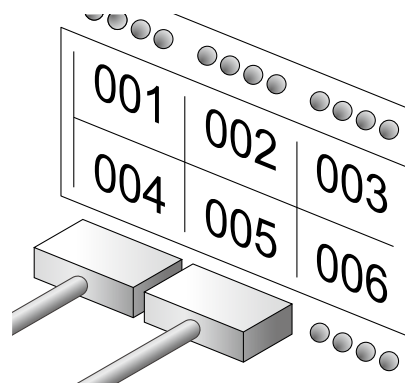
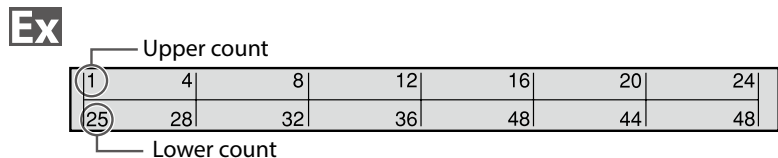

1. Press P.Block.
2. Select the blocks type with ▲/▼ and then press ↵.

In this example, we will select "4pairs".

Blank: Creates a table of two rows and one column.

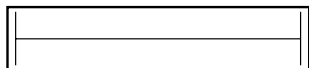

3. Select the text type with ▲/▼ and then press ↵.

In this example, we will select "Pins".

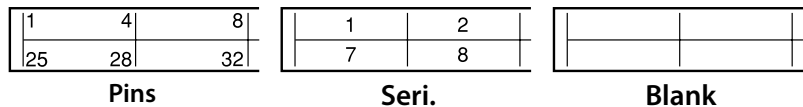

4. Enter the upper count and then press ↵.
In this example, we will enter "1".
5. Enter the lower count and then press ↵.
In this example, "25" is entered automatically.
6. Enter the label length and then press ↵.
Setting range: 1 to 99.9 cm
7. Press 🖨.

Top

Safety Instructions

Specifications

Troubleshooting

Part Names and Functions

Start Here

Cleaning

Initializing the Settings

Purpose-based Index

Key Menu Index

Frame and Table Lists

Creating Labels to Wrap Around Cable



You can repeatedly print text so that it can be seen regardless of the angle from which the cable is viewed.

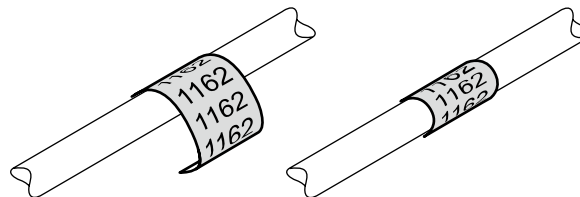
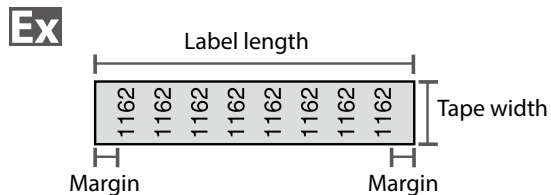

1. Press .
2. Select the length type with / and then press .

In this example, we will select "Length".

Dia: Sets the length by cable diameter.
(Setting range: 0.25 to 15 cm)

Length: Sets the length by label length.
3. Enter the label length and then press .

Setting range: 1 to 99.9cm

4. Select On or Off of repeat text with / and then press .

In this example, we will select "On".

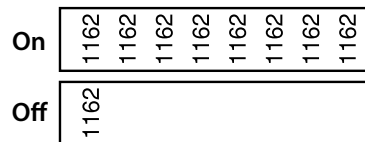

5. Select the type of margins with / and then press .

In this example, we will select "Long".

Tape/3: Sets margins that are a 1/3 of the tape width.
Tape: Sets margins that are equal to the tape width.

6. Enter the text.
7. Press .

Top

Safety Instructions

Specifications

Troubleshooting

Part Names and Functions

Start Here

Cleaning

Initializing the Settings

Purpose-based Index

Key Menu Index

Frame and Table Lists

Creating Labels to Wrap around Cable like a Flag

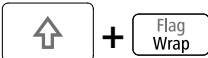

This label is useful for differentiating cables because the flag portion of the label wrapped around the cable is easy to see.

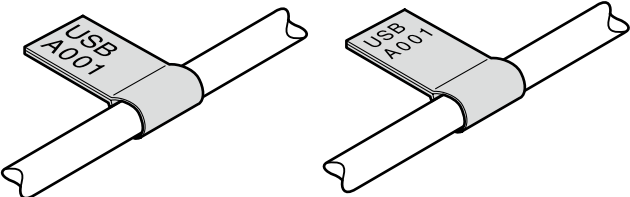
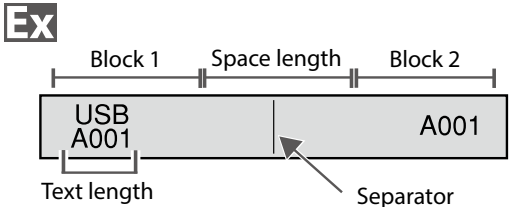

1. Press + .
2. Select the setting method of space length with / and then press .
 In this example, we will select "Length".
Dia: Sets the length by cable diameter.
 (Setting range: 0.25 to 15 cm)
Length: Sets the length by space length.
3. Enter the space length and then press .
 Setting range: 0.25 to 30 cm
4. Enter the text length and then press .
 Setting range: 0.25 to 30cm
5. Select the type of separator with / and then press .
 In this example, we will select "Line".

6. Select the orientation with / and then press .

In this example, we will select "Hori.2".

Hori.1	USB A001	USB A001
Hori.2	USB A001	A001
Vert.1	USB A001	USB A001
Vert.2	USB A001	A001
Vert.3	USB A001	USB A001
Vert.4	USB A001	A001

7. Enter the text of block 1 and then press .
8. Enter the text of block 2.
9. Press .

- Top
- Safety Instructions
- Specifications
- Troubleshooting
- Part Names and Functions
- Start Here
- Cleaning
- Initializing the Settings
- Purpose-based Index**
- Key Menu Index
- Frame and Table Lists

Creating Multiple Labels at Once

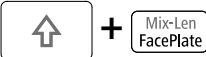

You can create many labels at once.

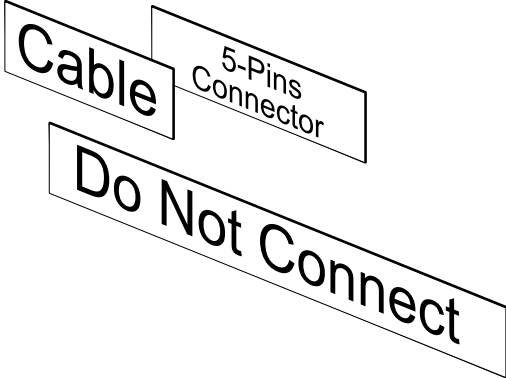
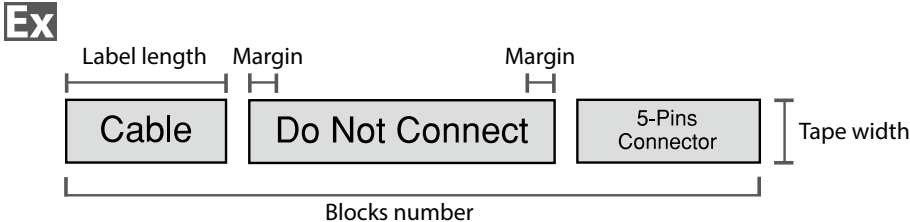

1. Press + .
2. Select the label length with / and then press .
Auto: Automatically adjusts the label length depending on the length of text.
Set: Sets the label length.
 Setting range: 1 to 99.9 cm
3. Enter the blocks number and then press .
 In this example, we will enter "3".

4. Select the type of margins with / and then press .
Tape/3: Sets margins that are a 1/3 of the tape width.
Tape: Sets margins that are equal to the tape width.
5. Select the orientation with / and then press .
 In this example, we will select "Hori.":
 Hori.
 Vert.1
 Vert.2
6. Enter "Cable" and then press .
 Similarly for other labels, enter text and press .
7. Press .

Top

Safety Instructions

Specifications

Troubleshooting

Part Names and Functions

Start Here

Cleaning

Initializing the Settings

Purpose-based Index

Key Menu Index

Frame and Table Lists





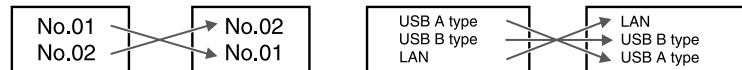

Swap the Order of Multiple Lines

Swaps the text line by line.



MEMO

You may not be able to swap the lines depending on the label type you create.

1. Press .
2. Select "Line swap" with / and press .
3. Select an area to which you want to apply the function with / and press .

Top

Safety Instructions

Specifications

Troubleshooting

Part Names and Functions

Start Here

Cleaning

Initializing the Settings

Purpose-based Index

Key Menu Index

Frame and Table Lists

Creating Labels with Dedicated Tape

■ Die-Cut label

Use the dedicated Die-Cut label. You can print on to pre-cut rounded corner label, oval label, and circular label.



Ex

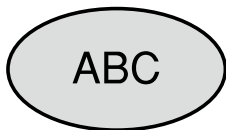

1. Select the orientation with / and then press .

In this example, we will select "Hori.".

Hori.

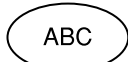

Vert.



2. Enter the text.

You can adjust the position of the text by changing the LW-PX900 settings. For details, see "Changing the LW-PX900 Settings".

3. Press .

■ Self-Lamination Overwrap

Use the dedicated Self-Lamination Overwrap. This label tape comes with transparent film. The film can be wrapped around the label to prevent it from getting dirty.

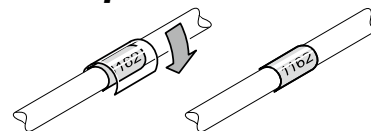

Ex

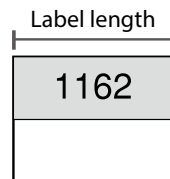

1. Enter the label length and then press . Setting range: 1 to 99.9 cm
2. Enter the text.
3. Press .

Top

Safety Instructions

Specifications

Troubleshooting

Part Names and Functions

Start Here

Cleaning

Initializing the Settings

Purpose-based Index

Key Menu Index

Frame and Table Lists

Creating Barcode Labels



MEMO

- You may not be able to add a barcode depending on the label type you create.
- Only up to two barcodes can be inserted in one label.

Supported barcode types:

EAN-8, EAN-13, CODE128, CODE39, QR CODE, ITF, CODABAR, UPC-A, UPC-E

1. Press
2. Select an item with / and press . Move on to the next options until the setting is complete.
3. Enter the alphanumeric characters for the barcode and then press .
4. Press .

Creating Labels with Symbol



1. Press .
2. Select a category with / and press .
3. Select a symbol with / and press .
4. Press .

MEMO

For available symbols, see "Symbol List" on the separate sheet.

Top

Safety Instructions

Specifications

Troubleshooting

Part Names and Functions

Start Here

Cleaning

Initializing the Settings

Purpose-based Index

Key Menu Index

Frame and Table Lists

Creating Sequentially Numbered Labels



The number is automatically incremented each time a label is printed. Up to four digits including numbers (0 to 9) and alphabet letters (a to z and A to Z) can be entered.

Ex

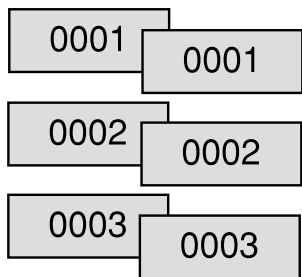

1. Press
2. Enter the start value of the sequential numbers and then press .
In this example, we will enter "0001".
3. Select the number of repetition with / and then press .
In this example, we will select "2 times".
4. Press + .
5. Select "Print copies" with / and then press .
6. Enter the number of print copies and then press .
In this example, we will enter "6".
7. Select "Start print?" with / and then press .
Printing starts.

Creating Labels with Block Sequence Numbers Assigned

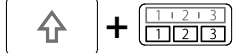

You can assign sequential numbers to blocks. Up to four digits including numbers (0 to 9) and alphabet letters (a to z and A to Z) can be entered.

Ex

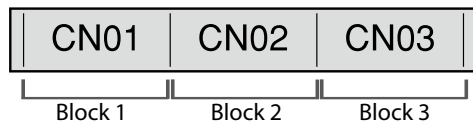

Create the blocks in advance. In this example, we have created three blocks.

1. Press +
2. Enter the start value of the sequential numbers and then press .
In this example, we will enter "CN01". Sequential numbers are automatically assigned to block 2 and block 3.
3. Select the number of repetition with / and then press .
In this example, we will select "1 time".
4. Press .

Top

Safety Instructions

Specifications

Troubleshooting

Part Names and Functions

Start Here

Cleaning

Initializing the Settings

Purpose-based Index

Key Menu Index

Frame and Table Lists

Customizing Labels

Setting the Format and Style (Edit menu)



Procedure for setting

1. Place the cursor.

Place the cursor on the left of the characters to which you want to apply a function.

If you apply the function to a specific line or block, confirm that the cursor is in the line or block.

2. Press .

Example: to apply "Bold & Italic"

3. Select "Bold & Italic" with / and press .

4. Select "B + I" with / and press .

5. Select an area to which you want to apply the function with / and press .

When "character" is selected, the function is applied to all characters on the right of the cursor.

MEMO

The setting items displayed when you press  differ depending on the label type you create.

You can decorate your label by setting the following.

Layout

Left, Center, Justify, Right

Adjusts the layout when multiple lines are used.

Frame & Table

Decorates the text with a frame or inserts a table.

Separator

Decorates the text of a die cut label with a frame.

For the frames that can be inserted  "Die-Cut label"

Style

Outline, Normal, Gray, Shadow, S+O

Applies a character style to text.

Char. spacing

None, Narrow, Normal, Wide

Sets the inter-character spacing.

Border & Line

Strikeout, Underline, None, Border, Round brdr, Shading, Brdr mesh, Round mesh

Applies border, underline, shade etc. to text.

Char. Width

Smaller, Small, Narrow, Normal, Wide

This allows you to change the width or height of characters.

Top

Safety Instructions

Specifications

Troubleshooting

Part Names and Functions

Start Here

Cleaning

Initializing the Settings

Purpose-based Index

Key Menu Index

Frame and Table Lists

Background

None, 1 Wave, 2 Diamond1, 3 Diamond2, 4 Snow, 5 Flower, 6 Star, 7 Cards, 8 Arabesq., 9 Mesh, 10Dotted

Sets the background pattern.

Bold & Italic

Italic, Normal, Bold, B+I

Changes the text in bold or italics.

Length

This setting is the same as when  is pressed.

 "Setting the Label Length"

Margins

This setting is the same as when  is pressed.

 "Setting the Margins"

Orientation

|AB|A, |A B|, |AB|AB

Sets the orientation of the text.

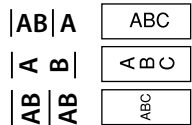

Font size



Select font size from preset patterns or from "Manual".

When "Manual" is selected, font size can be set for each block line by line.

 "Changing the Font Size"

 "Specifying the Font Size"

Font

This setting is the same as when  +  is pressed.

 "Changing the Font"

Line swap

Swaps the order of text line by line.

You may not be able to swap the lines depending on the label type you create.

 "Swap the Order of Multiple Lines"

Color Reversal

On, Off

When set to "On", creates label with the text color and tape color reversed.

Top

Safety Instructions

Specifications

Troubleshooting

Part Names and Functions

Start Here

Cleaning

Initializing the Settings

Purpose-based Index

Key Menu Index

Frame and Table Lists

Changing the Font Size



You can change the font size of text by selecting from preset patterns.

To change the font size of a block line by line, set "Manual" under "Font size" of "Edit menu".

"Specifying the Font Size"

MEMO

- You may not be able to change the font size depending on the label type you create.
- If your text contains only the letters and/or marks described below, it is printed larger than text that contains the other letters and/or marks.
Numbers, English alphabet uppercase letters, space, and the following marks; ! " # % & ' * + - . / : < = > ? \ ^

- Press .
- Each time you press , the font size changes.

Changing the Font

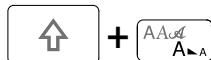

Changes the font type of text.

- Press + .
- Each time you press + , the font changes.

SansS. ABC Roman ABC

Changing the Text Orientation

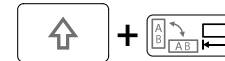

Changes the text orientation to vertical or horizontal.

MEMO

You may not be able to change the text orientation depending on the label type you create.

- Press + .

Each time you press + , the setting switches between "Horizontal" and "Vertical".

Horizontal ABC

Vertical < A B >

■ When creating "Patch Panel", "Block-66", "Faceplate", or "Mix-Len"

- Press + .

- Select the orientation with / and press .

Hori. ABC

Vert.1 A B >

Vert.2 ABC

Top

Safety Instructions

Specifications

Troubleshooting

Part Names and Functions

Start Here

Cleaning

Initializing the Settings

Purpose-based Index

Key Menu Index







Frame and Table Lists

Setting the Label Length

You can set the length of label or block.

MEMO

- This cannot be set for a die cut label.
- When creating a special label, you can set the length again. Setting items for special label is displayed after pressing .





1. Press .
2. Select the setting method of the length with / and press .
 - Auto:** Automatically adjusts the label length depending on the length of text.
 - Set:** Sets the label length. Setting range: 1 to 99.9 cm
3. Select the alignment for the text with / and press .
 - Left, Center, Justify, Right

Setting the Margins

Sets the left and right margins.

MEMO

You may not be able to set the margins depending on the label type you create.

1. Press .
2. Select the type of margins with / and press .
 - Tape width /3:** Sets margins that are a 1/3 of the tape width.
 - Tape width:** Sets margins that are equal to the tape width.

Adding Block

By dividing text into blocks, you can change the style and the number of lines block-by-block.

Display

```
01 1 Cable
    2 #101
02 1 USB No.1
    2 USB No.2
```

Label

```
Cable  USB No.1
#101   USB No.2
```

Block 1 Block 2

1. Press .

A new block is started from the character next to the cursor.

```
01 1 Cable
    2 #101|                  →                  01 1 Cable
    2 #101|                                   2 #101
02 1 |                                                  02 1 |
```

Top

Safety Instructions

Specifications

Troubleshooting

Part Names and Functions

Start Here

Cleaning

Initializing the Settings

Purpose-based Index

Key Menu Index

Frame and Table Lists



















Specifying the Font Size

You can change the font size of a block line by line.



MEMO

- The font sizes that can be set will differ depending on the width of the tape in use or the number of lines of text.
- The font size of the text is automatically adjusted according to the width of the tape. So even if the first line is set to the largest font size, its size may be changed depending on the font size settings of the second and third lines.

1. Press .
2. Select "Font size" with / and press .
3. Select the number of lines with / and press .
4. Select "Manual" with / and press .
5. Select the line to be changed with / and change the font size with /.
6. When the settings are complete, press .
7. Select an area to which you want to apply the function with / and press .

Top

Safety Instructions

Specifications

Troubleshooting

Part Names and Functions

Start Here

Cleaning

Initializing the Settings

Purpose-based Index

Key Menu Index









Frame and Table Lists

Saving Frequently Used Labels











By saving frequently used labels, you will be able to easily recall and print from them next time. Up to 100 labels can be saved.

■ Saving a label











1. Press .
2. Select " Save " with / and press .
3. Select a registration number with / or the number keys and then press .
The registration confirmation screen appears.
4. Confirm the registration number and then press .

■ Recall the saved label



1. Press .
2. Select " Recall " with / and press .
3. Select a registration number with / or the number keys and then press .
The recall confirmation screen appears.
4. Confirm the registration number and then press .

■ Printing the saved label









You can select multiple files and print them at once.

1. Press .
2. Select " Print " with / and press .
3. Select a registration number with / or the number keys and then press .
By continuously selecting registration numbers and pressing , you can select multiple files.
4. Select " Print Start " with / and press .
Printing starts.

MEMO

You can also select " Print Start " by pressing  + /.

■ Deleting the saved label

1. Press .
2. Select " Delete" with / and press .
3. Select a registration number with / or the number keys and then press .
The deletion confirmation screen appears.
4. Confirm the registration number and then press .

Top

Safety Instructions

Specifications

Troubleshooting

Part Names and Functions

Start Here

Cleaning

Initializing the Settings

Purpose-based Index

Key Menu Index

Frame and Table Lists

Utilizing Print Functions

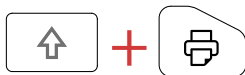

■ Enlarge print

You can create a label that is larger than the width of a single label.

Print the created content separately on multiple labels and then put them together to use as a single label.



1. Press + .
 2. Select "Enlarge print" with / and press .
 3. Select "*2size" with / and press .
 4. Select "2/2" with / and press .
 5. Select "Start print?" with / and press .
- Printing starts.

MEMO

The function remains enabled even after printing. To disable the function, select "Off".

■ Mirror print



1. Press + .
 2. Select "Mirror print" with / and press .
 3. Select "On" with / and press .
 4. Select "Start print?" with / and press .
- Printing starts.

MEMO

The function remains enabled even after printing. To disable the function, select "Off".

■ Print copies



1. Press + .
 2. Select "Print copies" with / and press .
 3. Enter the number of print copies and then press .
 4. Select "Start print?" with / and press .
- Printing starts.

MEMO

The function remains enabled even after printing. To disable the function, set the number of print copies to "1".

Top

Safety Instructions

Specifications

Troubleshooting

Part Names and Functions

Start Here

Cleaning

Initializing the Settings

Purpose-based Index

Key Menu Index

Frame and Table Lists

Changing the LW-PX900 Settings



+



Auto cut

Sets whether or not to cut automatically.

When "Auto cut" is set to " On ", the function (Half cut) for precutting just the label part to make the backing paper easy to peel off is set.

Print density

Sets the print density.

Drop stop

This function is useful for affixing consecutively printed labels one at a time.

When "On" is selected, printed labels will not be scattered because they are stacked in the tape eject slot and a label is output each time a label is removed.

This function is only available when the label length is 28 mm or more, "Auto cut" is set to "On", and "Half cut" is set to "Off".

Die-Cut pos

Adjusts the text position of die cut label.

Width pos: Adjusts the vertical positioning of text.

Length pos: Adjusts the horizontal positioning of text.

Backlight

Sets the display backlight to On or Off.

Language

You can select the language shown on the display from the following:

Dansk, Deutsch, English, Español, Français, Italiano, Nederlands, Norsk, Português-Br, Português-EU, Suomi, Svenska, Türkçe

inch:cm

The unit of length used to indicate the label size can be switched between inch and cm.

MEMO

Version: To make sure the version number that has been installed in the printer.

Procedure for setting

1. Press + .
2. Select the desired function with / and press .
3. Select the desired item with / and press .

Top

Safety Instructions

Specifications

Troubleshooting

Part Names and Functions

Start Here

Cleaning

Initializing the Settings

Purpose-based Index

Key Menu Index

Frame and Table Lists

Transferring Cable Label Data

If you transfer a label data you created to the LW-PX900, you will be able to print labels for cables without connecting to a computer.

Operation flow

Operation on computer

Label Editor Professional

1. Create the label for transfer

Data Transfer Tool

2. Transfer the label data

Operation on LW-PX900

3. Print from the LW-PX900

MEMO

- For how to install and operate Label Editor Professional, see "Label Editor Professional User's Guide".
- Connect LW-PX900 and computer with a USB cable in advance.

1. Create the label for transfer

1. Start Label Editor Professional.
2. Click [Cable Labeling] in the "New/Open" window.
3. Click [OK].

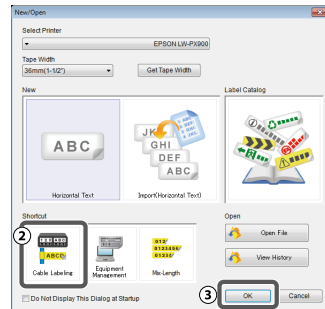

4. Turn on the checkbox of "Create Transfer Data" on the "Style" tab.

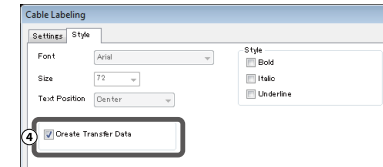

5. Click "Label Type" on the "Settings" tab. Select the label type.
6. Create the label.

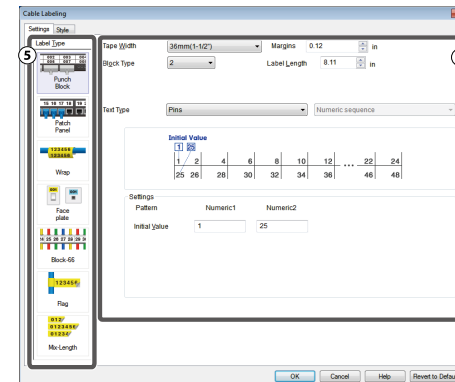

Top

Safety Instructions

Specifications

Troubleshooting

Part Names and Functions

Start Here

Cleaning

Initializing the Settings

Purpose-based Index

Key Menu Index

Frame and Table Lists

2. Transfer the label data

1. Click [Transfer].

Data Transfer Tool starts.

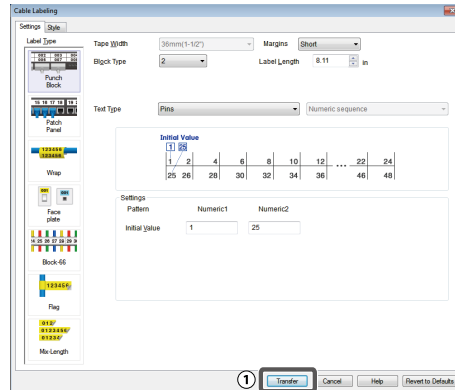

2. Click [Save].

The label data for transfer is saved on the computer.

This printer does not support this function.

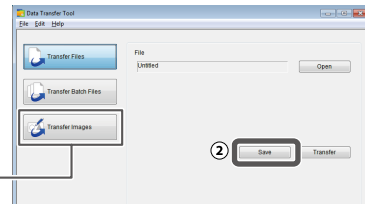

MEMO

By clicking [Transfer], you can transfer the data immediately without saving it.

3. Click [Transfer Batch Files].

4. Click [Add].

Select the label data to transfer.

5. Click [Transfer].

The label data is transferred to the LW-PX900.

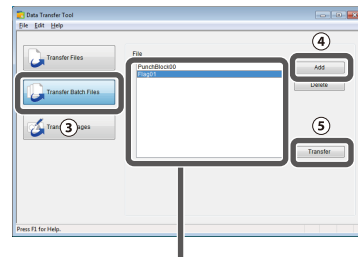

The file name of the selected label data is displayed.

3. Print from the LW-PX900

The transferred label data can be printed from of the LW-PX900.

1. Press .
 2. Select "Print" with / and then press .
 3. Select the transferred label data with / or a numeric key and then press .
 4. Select "Print Start" with / and then press .
- Printing starts.

Top

Safety Instructions

Specifications

Troubleshooting

Part Names and Functions

Start Here

Cleaning

Initializing the Settings

Purpose-based Index

Key Menu Index

Frame and Table Lists

Key Menu Index

Click a key in the illustration to display the menu list.

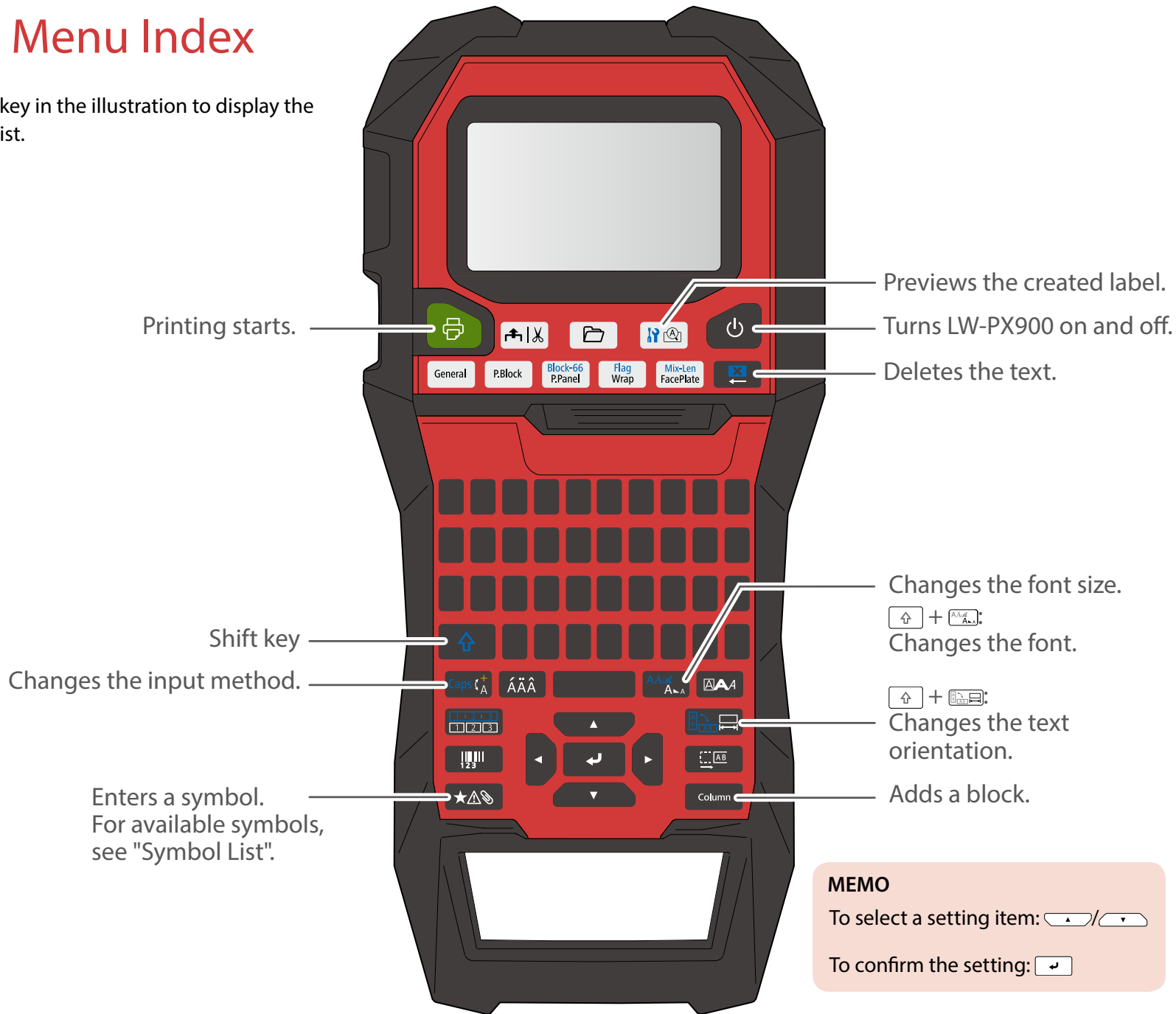

- Top
- Safety Instructions
- Specifications
- Troubleshooting
- Part Names and Functions
- Start Here
- Cleaning
- Initializing the Settings
- Purpose-based Index
- Key Menu Index**
- Frame and Table Lists

Patch Panel

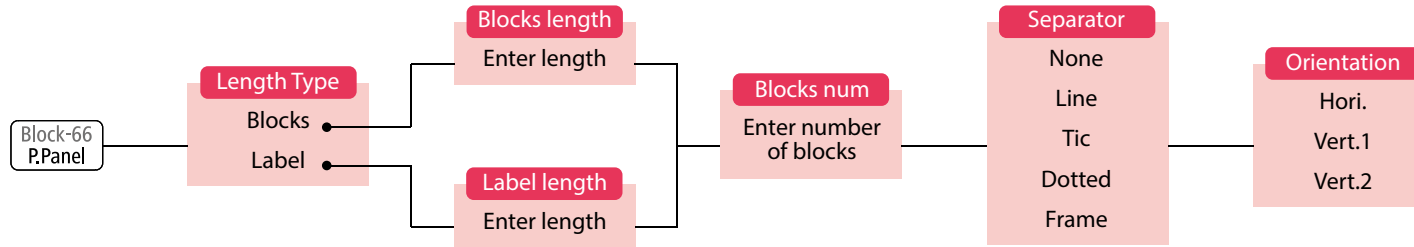

Block-66

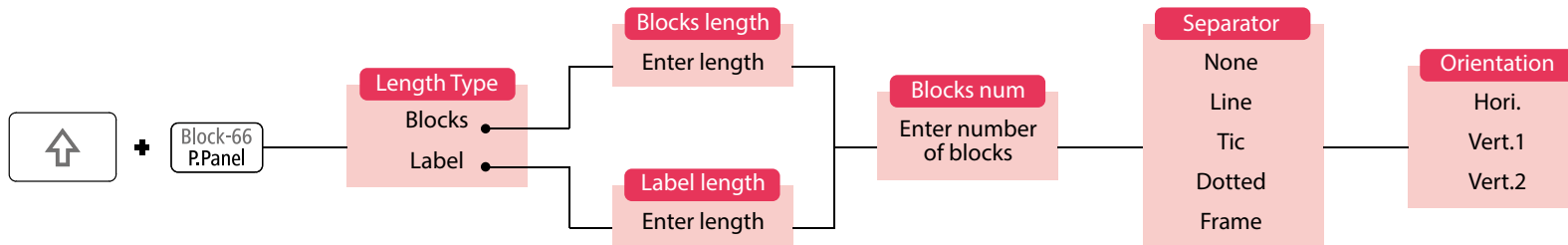

Top

Safety Instructions

Specifications

Troubleshooting

Part Names and Functions

Start Here

Cleaning

Initializing the Settings

Purpose-based Index

Key Menu Index

Frame and Table Lists

Faceplate

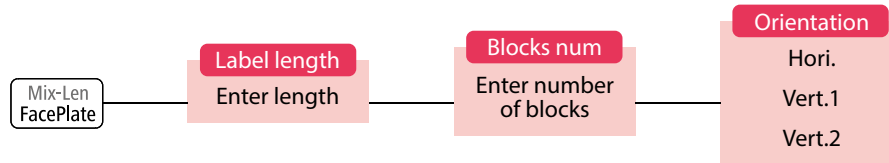

Mix-Len

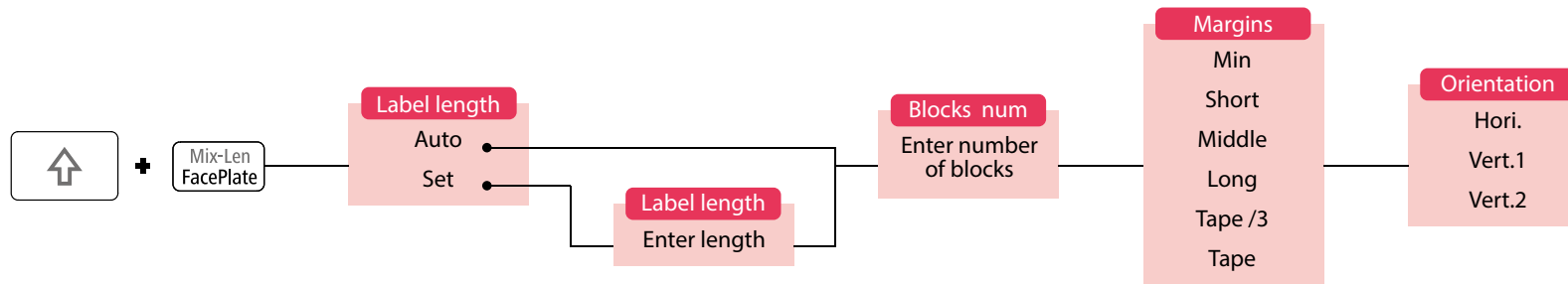

Top

Safety Instructions

Specifications

Troubleshooting

Part Names and Functions

Start Here

Cleaning

Initializing the Settings

Purpose-based Index

Key Menu Index

Frame and Table Lists

Wrap

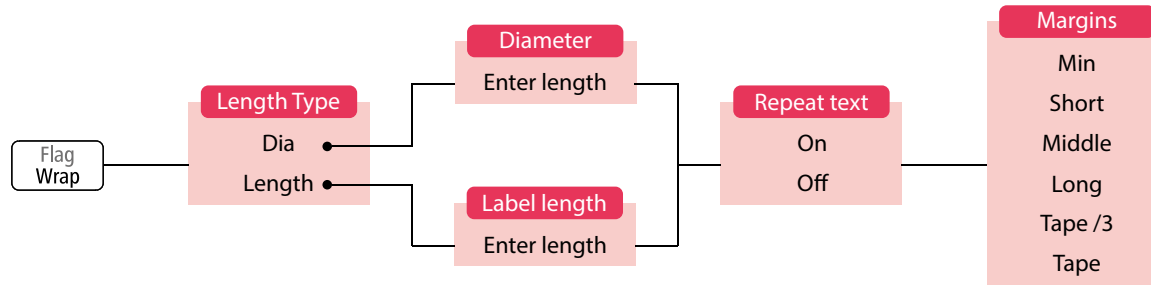

Flag

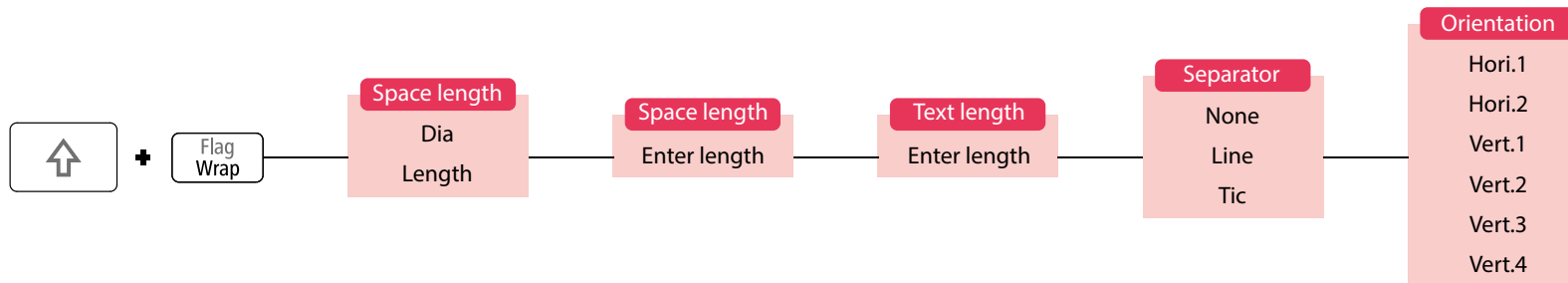

Top

Safety Instructions

Specifications

Troubleshooting

Part Names and Functions

Start Here

Cleaning

Initializing the Settings

Purpose-based Index

Key Menu Index

Frame and Table Lists

Punch Block

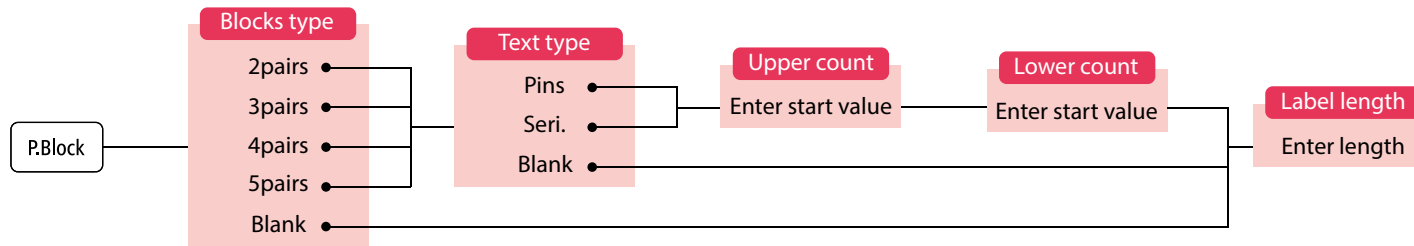

Top

Safety Instructions

Specifications

Troubleshooting

Part Names and Functions

Start Here

Cleaning

Initializing the Settings

Purpose-based Index

Key Menu Index

Frame and Table Lists

Edit 1

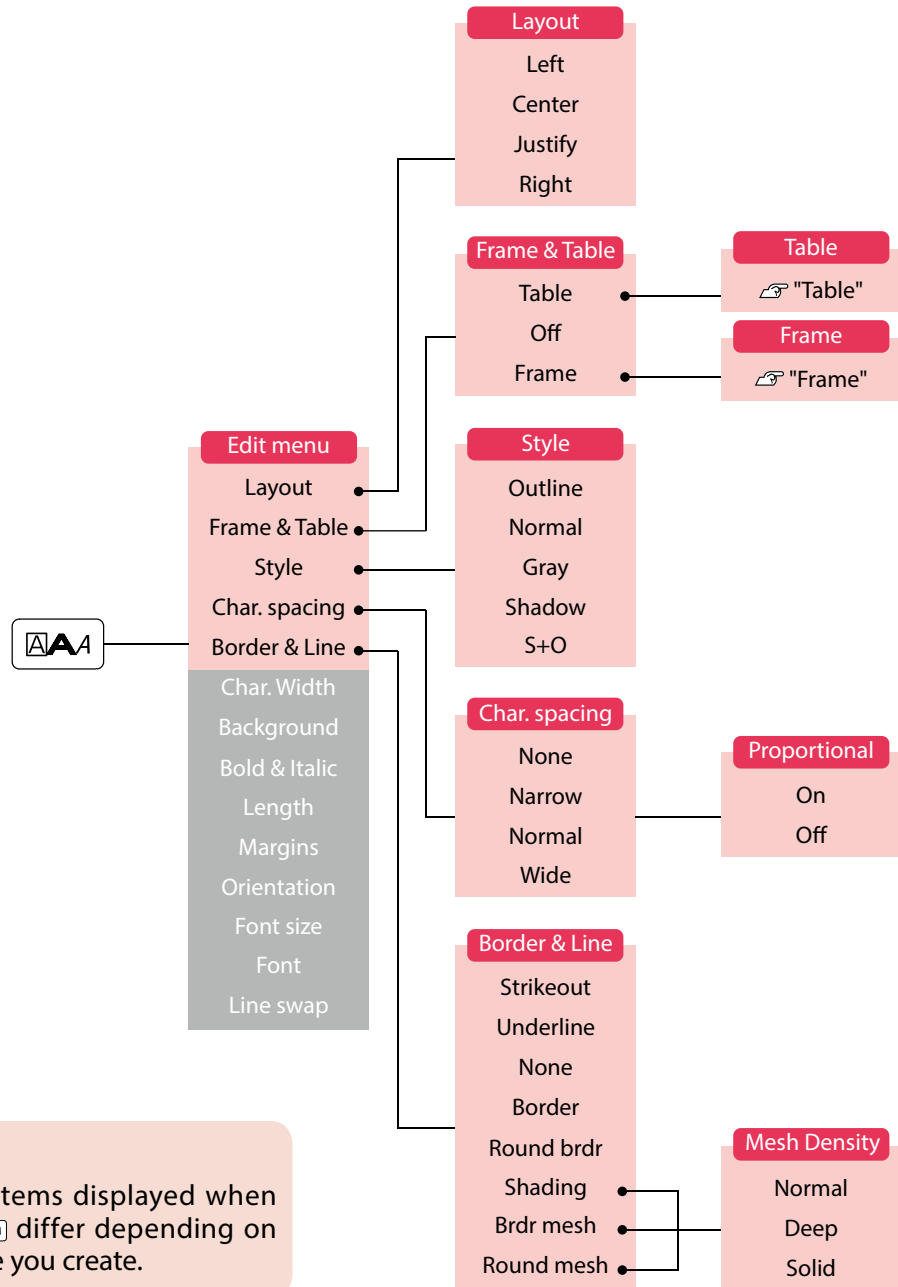

MEMO

The setting items displayed when you press differ depending on the label type you create.



- Top
- Safety Instructions
- Specifications
- Troubleshooting
- Part Names and Functions
- Start Here
- Cleaning
- Initializing the Settings
- Purpose-based Index
- Key Menu Index
- Frame and Table Lists

Edit 2

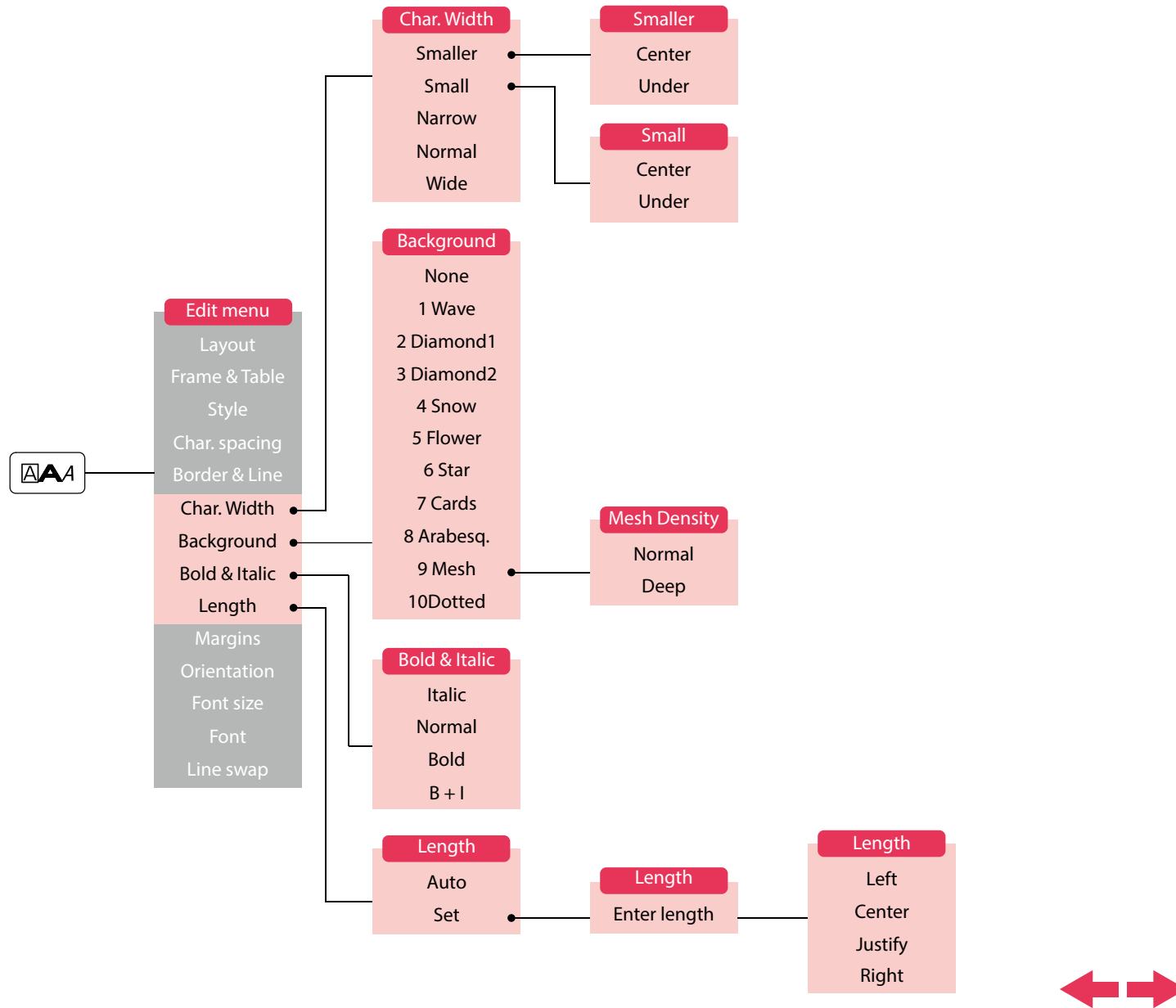

Top

Safety Instructions

Specifications

Troubleshooting

Part Names and Functions

Start Here

Cleaning

Initializing the Settings

Purpose-based Index

Key Menu Index

Frame and Table Lists

Edit 3

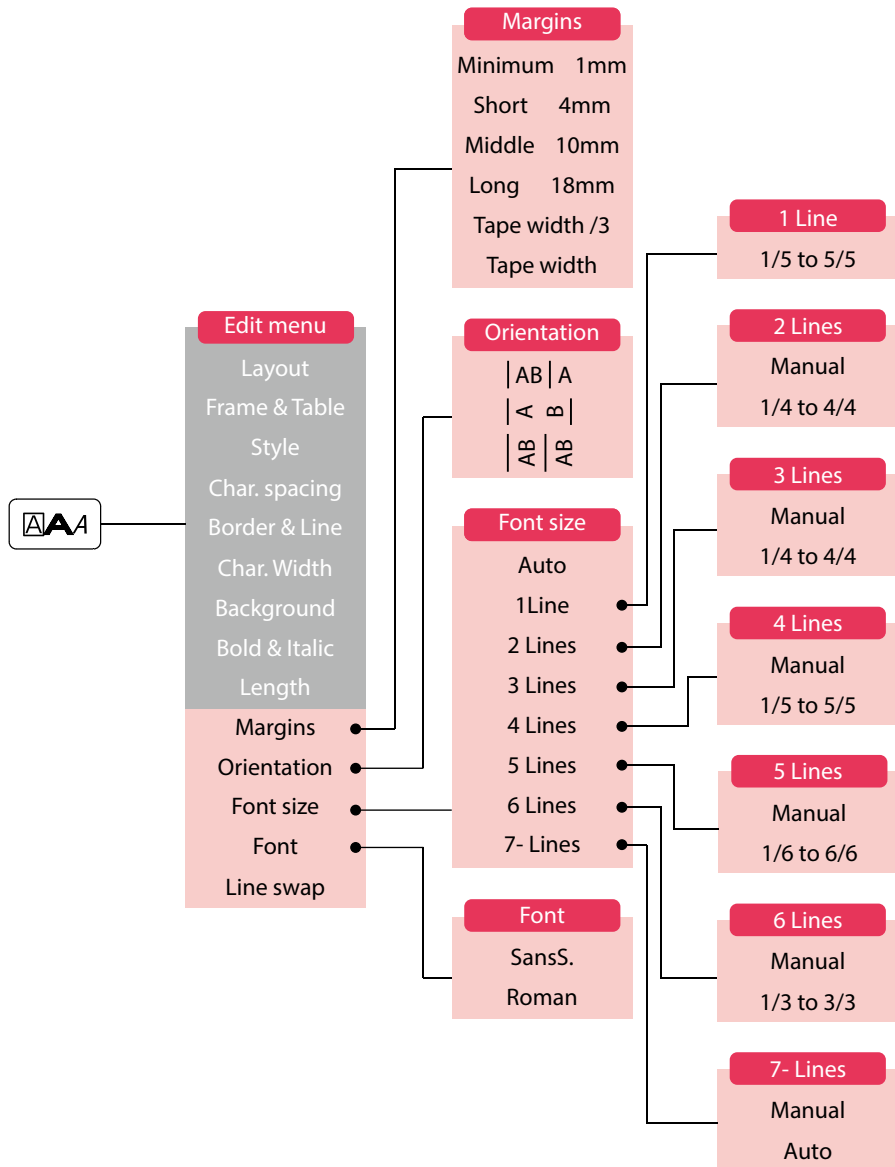

- Top
- Safety Instructions
- Specifications
- Troubleshooting
- Part Names and Functions
- Start Here
- Cleaning
- Initializing the Settings
- Purpose-based Index
- Key Menu Index
- Frame and Table Lists

Margins

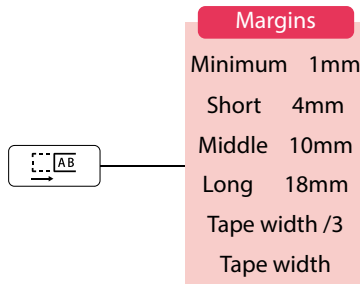

MEMO

The setting items displayed when you press  differ depending on the label type you create.

Length

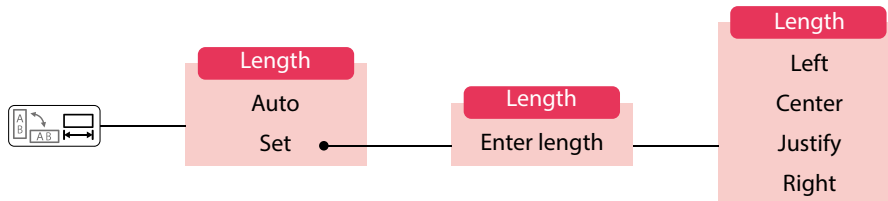

MEMO

The setting items displayed when you press  differ depending on the label type you create.

Top

Safety Instructions

Specifications

Troubleshooting

Part Names and Functions

Start Here

Cleaning

Initializing the Settings

Purpose-based Index

Key Menu Index

Frame and Table Lists

Serialize

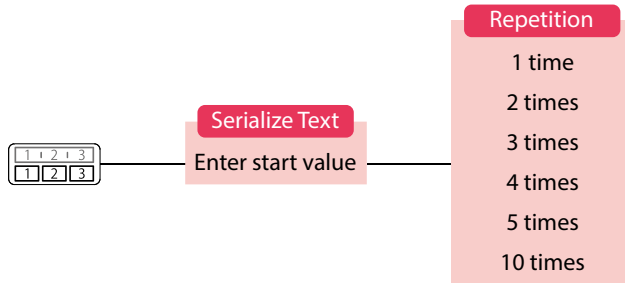

Advanced Serialize

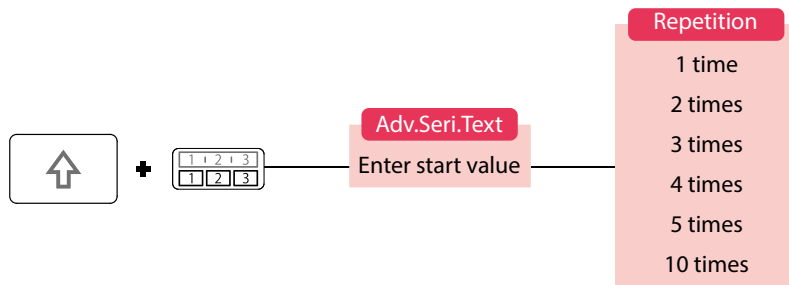

Top

Safety Instructions

Specifications

Troubleshooting

Part Names and Functions

Start Here

Cleaning

Initializing the Settings

Purpose-based Index

Key Menu Index

Frame and Table Lists

Barcode 1

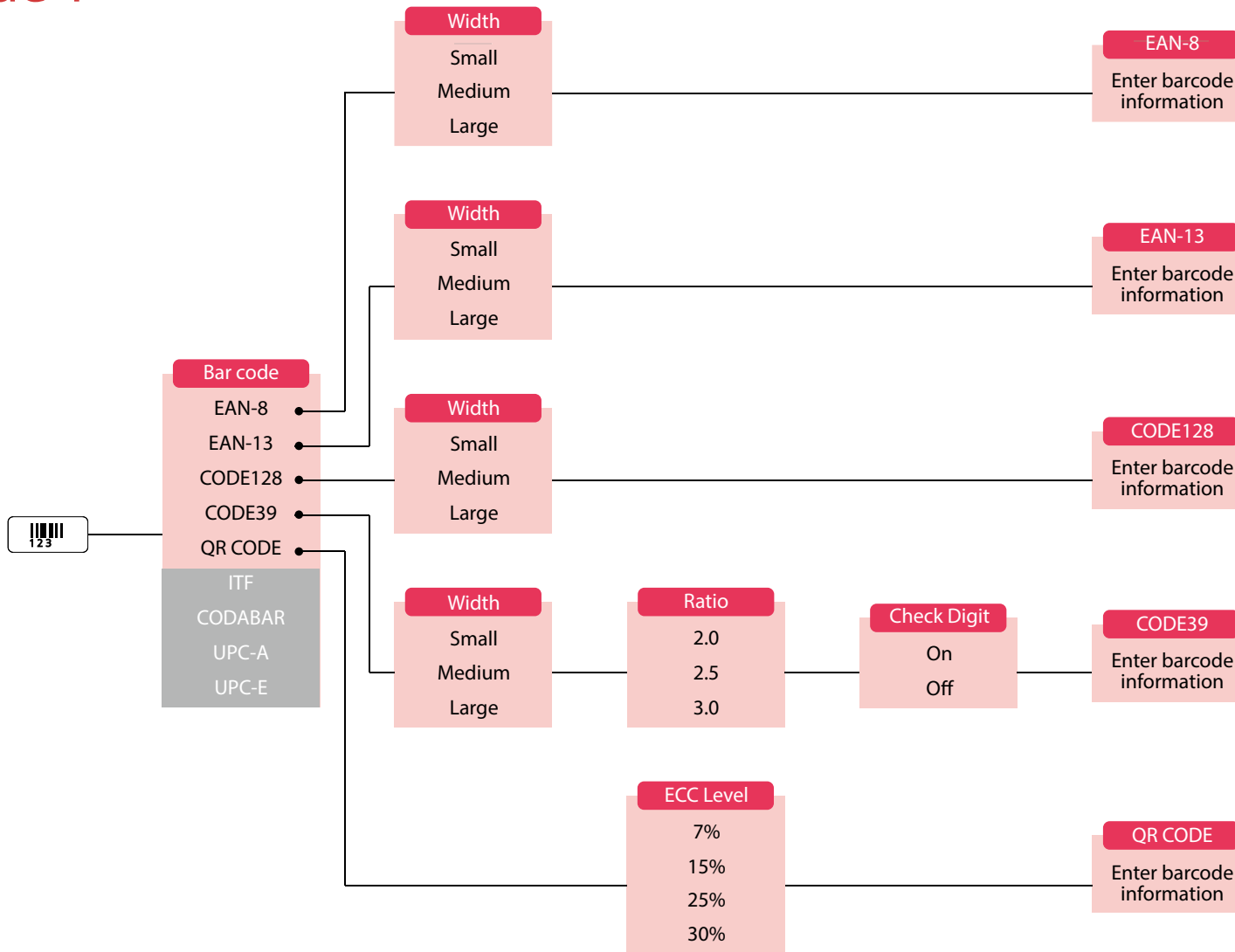

Top

Safety Instructions

Specifications

Troubleshooting

Part Names and Functions

Start Here

Cleaning

Initializing the Settings

Purpose-based Index

Key Menu Index

Frame and Table Lists

Barcode 2

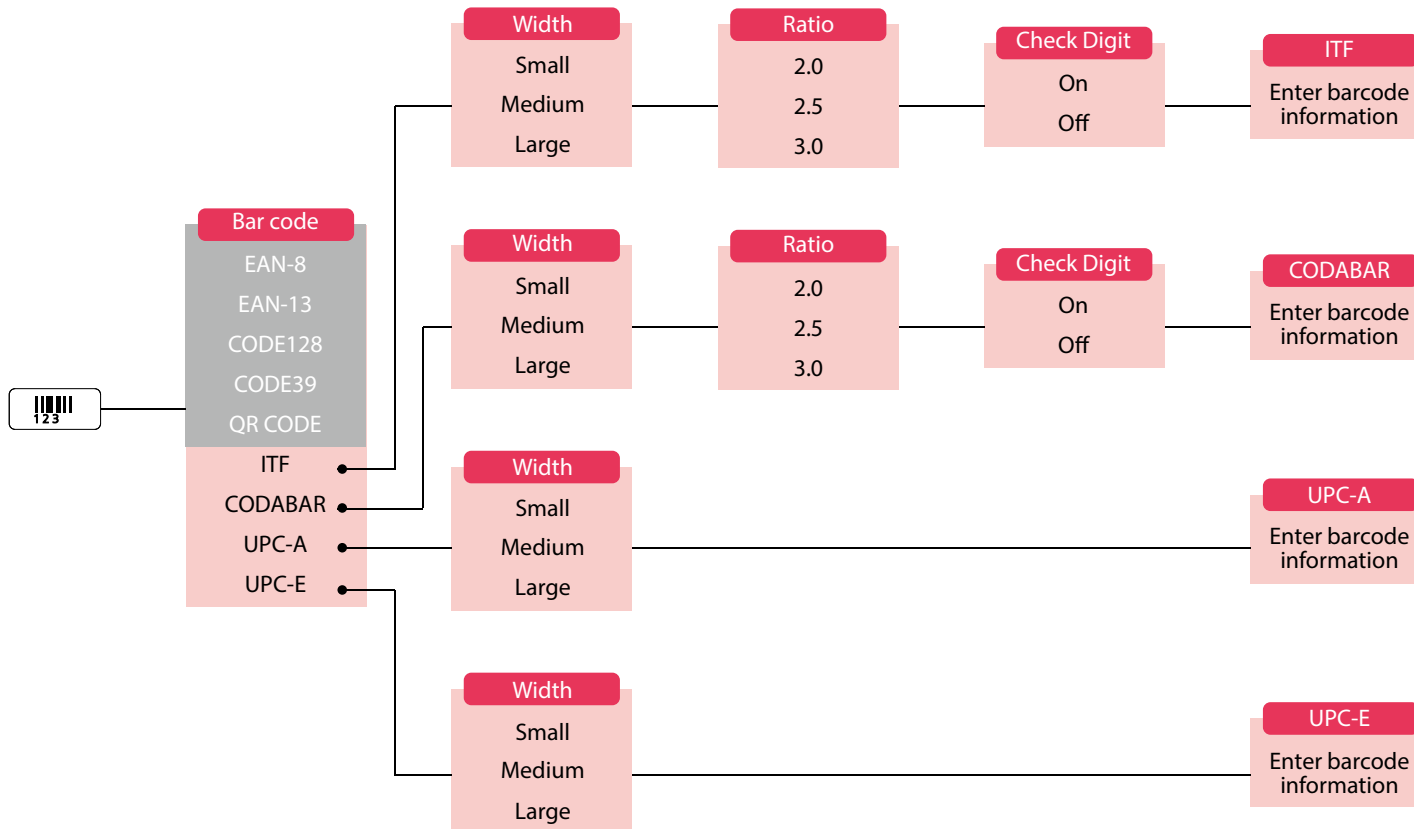

- Top
- Safety Instructions
- Specifications
- Troubleshooting
- Part Names and Functions
- Start Here
- Cleaning
- Initializing the Settings
- Purpose-based Index
- Key Menu Index
- Frame and Table Lists

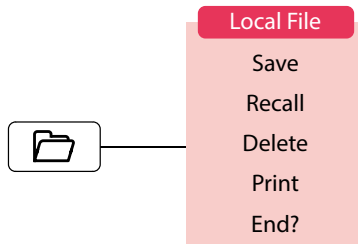

File

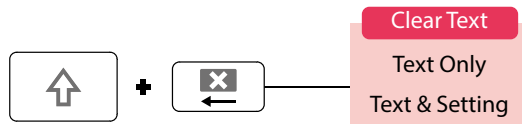

Clear



MEMO

The setting items displayed when you press  +  differ depending on the label type you create.

Top

Safety Instructions

Specifications

Troubleshooting

Part Names and Functions

Start Here

Cleaning

Initializing the Settings

Purpose-based Index

Key Menu Index

Frame and Table Lists

Multi print

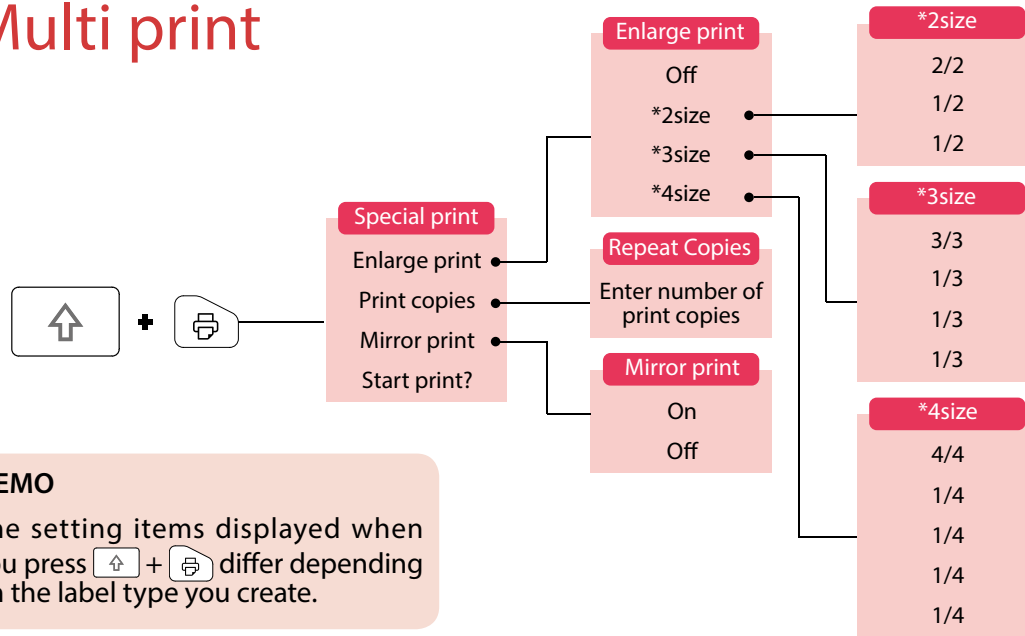

MEMO

The setting items displayed when you press + differ depending on the label type you create.

Feed and Cut

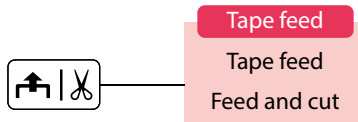

Top

Safety Instructions

Specifications

Troubleshooting

Part Names and Functions

Start Here

Cleaning

Initializing the Settings

Purpose-based Index

Key Menu Index

Frame and Table Lists

Setting 1

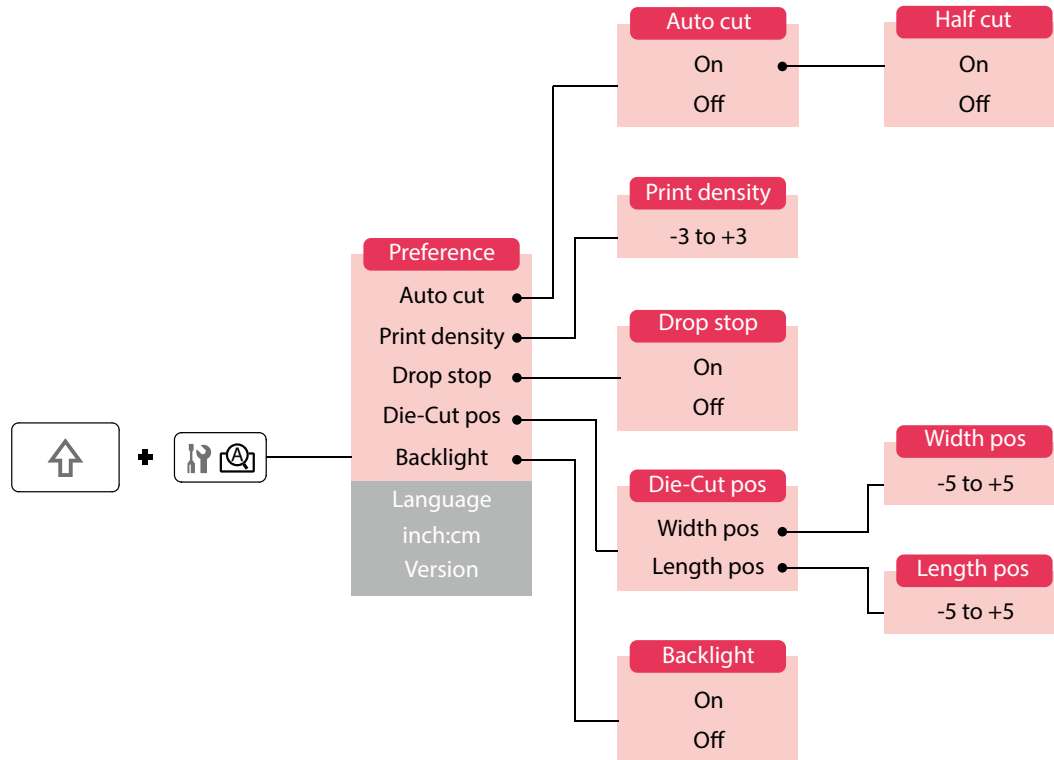

- Top
- Safety Instructions
- Specifications
- Troubleshooting
- Part Names and Functions
- Start Here
- Cleaning
- Initializing the Settings
- Purpose-based Index
- Key Menu Index
- Frame and Table Lists

Setting 2

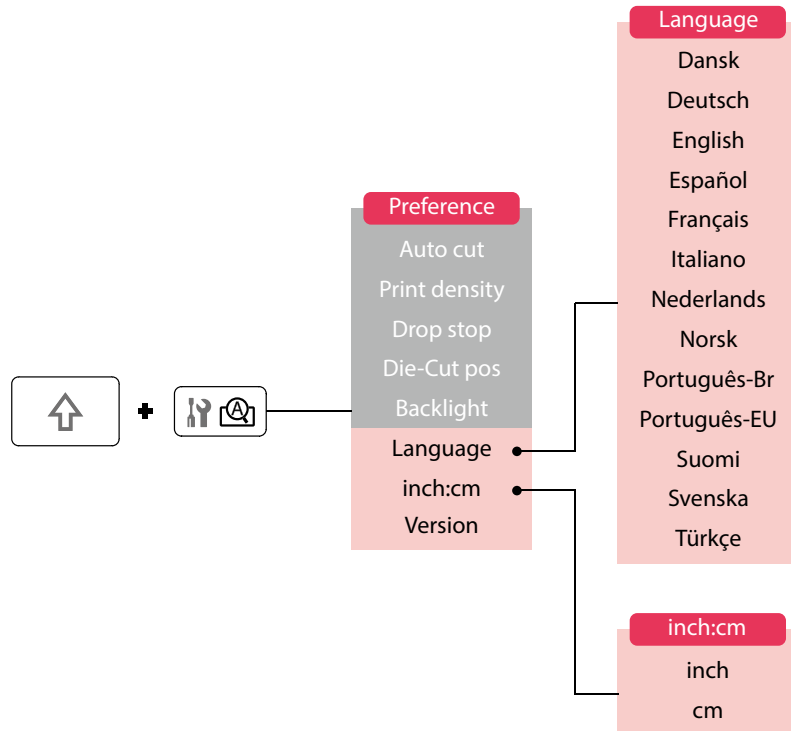

Top

Safety Instructions

Specifications

Troubleshooting

Part Names and Functions

Start Here

Cleaning

Initializing the Settings

Purpose-based Index

Key Menu Index

Frame and Table Lists

Accent

A	Á À Â Ã Ä Å Æ Ā Ą Ă
C	Ç Ć Ć Ć
D	Đ Ď
E	É È Ě Ê Ę Æ Ø Ē Ę Ę Ě
G	Ĝ Ğ Ğ Ğ
H	Ĥ
I	Í Ĩ Î Ì Ĭ Ī ĺ ĩ
K	Ķ
L	Ľ Ł Ł Ł Ł
N	Ñ Ń Ń Ń Ń Đ
O	Ó Ô Œ Ő Ò Ö Ø Ő Ō Ő
P	Ɔ
R	Ř Ř
S	Š Ś Ś
T	Ť Ƨ Ƨ
U	Ú Ü Ù Û Ů Ű Ū Ů Ů
W	Ŵ
Y	Ý Ÿ Ÿ
Z	Ž Ž Ž Ʒ

a	á à â ã ä å æ ą ā ą ă
c	ç ć Ć Ć
d	ď đ đ'
e	é è ě ê ę æ ē ę è ě
g	ğ ğ ğ
h	ħ
i	í Ĩ Î Ì Ĭ Ī ĺ ĩ
k	ķ
l	ł ł ł ł ł
n	ñ Ń Ń Ń Ń Ń
o	ó ô œ ő ò ö ø ő ō ő
p	Ɔ
r	ř ř
s	š ś ś ś ś
t	ť Ƨ Ƨ
u	ú ü ù û ů Ű Ū Ů Ů
w	Ŵ
y	ý Ÿ Ÿ
z	ž ž ž Ʒ
?	¿
!	!

Top

Safety Instructions

Specifications

Troubleshooting

Part Names and Functions

Start Here

Cleaning

Initializing the Settings

Purpose-based Index

Key Menu Index

Frame and Table Lists

Frame and Table Lists

Frame

1		2		3		4		5		6		7	
8		9		10		11		12		13		14	
15		16		17		18		19		20		21	
22		23		24		25		26		27		28	
29		30		31		32		33		34		35	
36		37		38		39		40		41		42	
43		44		45		46		47		48		49	
50		51		52		53		54		55		56	
57		58		59		60		61		62		63	
64		65		66		67		68		69		70	
71		72		73		74							

Top

Safety Instructions

Specifications

Troubleshooting

Part Names and Functions

Start Here

Cleaning







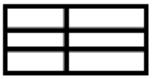
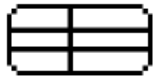

Initializing the Settings

Purpose-based Index

Key Menu Index

Frame and Table Lists

Table

1		2		3		4		5		6		7	
8		9		10									

Top

Safety Instructions

Specifications

Troubleshooting

Part Names and Functions

Start Here

Cleaning

Initializing the Settings

Purpose-based Index

Key Menu Index

Frame and Table Lists

Die-Cut label

■ Circle

1		2		3		4		5		6		7	
8		9		10									

■ Oval

1		2		3		4		5		6		7	
8		9		10									

■ Rectangle

1		2		3		4		5		6		7	
8		9		10		11		12		13		14	
15		16											

■ Table

1		2		3		4	
---	--	---	--	---	--	---	--

Top

Safety Instructions

Specifications

Troubleshooting

Part Names and Functions

Start Here

Cleaning

Initializing the Settings

Purpose-based Index

Key Menu Index

Frame and Table Lists