



# TRAC-LITES

One Circuit Trac System

## TRAC SECTIONS & SYSTEM COMPONENTS

### R Series

Project: \_\_\_\_\_

Fixture Type: \_\_\_\_\_

Location: \_\_\_\_\_

Contact/Phone: \_\_\_\_\_



#### PRODUCT DESCRIPTION

Reduced-profile, single-circuit trac sections for surface or pendant mounting. Compatible with a full range of feed, connector and mounting accessories, as listed on back of this page. Accepts all Trac-Lites and Trac-Master trac fixtures.

#### PRODUCT SPECIFICATIONS

**Construction** Extruded aluminum with thermoplastic insulator • Injection molded polycarbonate dead-end with set screw • Standard lengths may be cut-to-length by installer.

**Electrical** Two 12 gauge solid copper conductors • Rated 20 amps at 120 volts • Aluminum channel used as system ground • One-piece insulator insures consistent conductor spacing for reliable electrical contact • Insulating bushings supplied at mounting hole locations to prevent shorts to ground.

**Labels** UL/CUL listed.

**Buy American** This product is assembled in the USA and meets the Buy America(n) government procurement requirements under FARS, DFARS and DOT. Please refer to [www.acuitybrands.com/buy-american](http://www.acuitybrands.com/buy-american) for additional information.

#### PRODUCT INSTALLATION

Debossed polarity line provides visual cue to proper trac, trac connector and fixture alignment • Supplied with toggle bolts for surface mounting • Insulator stays same length as extrusion to simplify field-cutting of trac • Connectors and feeds simply push into trac sections.

Specifications subject to change without notice.

#### DIMENSIONS

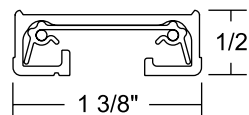
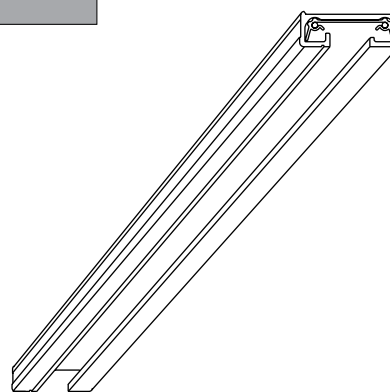
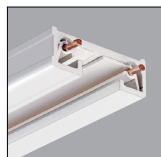

#### ORDERING INFORMATION

Example: R 8FT WH

Series	Length	Finish
R Trac-Lites 1-Circuit Track Sections	<b>2FT</b> 2-foot track section; actual length 19-7/8"	<b>BL</b> Black
	<b>4FT</b> 4-foot track section; actual length 43-7/8"	<b>BZ</b> Bronze
	<b>6FT</b> 6-foot track section; actual length 67-7/8"	<b>SL</b> Silver
	<b>8FT</b> 8-foot track section; actual length 91-7/8"	<b>WH</b> White

# TRAC-LITES

One Circuit Trac System

## TRAC SECTIONS & SYSTEM COMPONENTS R Series

### Electrical Feeds

Examples: R21 BL, R34 RP WH

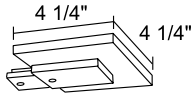
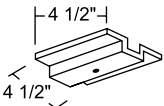
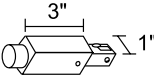
R21	R29	R34	R34 RP
BL, BZ, SL, WH	BL, BZ, SL, WH	BL, BZ, SL, WH	BL, BZ, WH
<p><b>End Feed Connector and Outlet Box Cover</b></p> <p>For outlet box feed. Includes: outlet box cover, fixture strap and ground screw.</p> 	<p><b>Floating Electrical Feed</b></p> <p>Permits mounting any point of trac under outlet box. Includes floating connector, outlet box cover plus extra trac dead end.</p> 	<p><b>Conduit End Feed</b></p> <p>For surface wiring. Use standard 1/2" connector.</p> 	<p><b>Conduit End Feed</b></p> <p>Same as R34 except designed for use in opposite polarity orientation compared to standard feed connectors.</p>

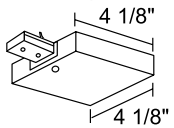
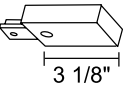
R36	R36 RP	R38	R38 RP
BL, BZ, SL, WH	BL, BZ, SL, WH	BL, BZ, SL, WH	BL, WH
<p><b>T-Bar End Feed</b></p> <p>Wiring compartment contains standard 1/2" KO's. Feeds surface trac from above, when T-bar is directly above trac.</p> 	<p><b>T-Bar End Feed</b></p> <p>Same as R36 except designed for use in opposite polarity orientation compared to standard feed connectors.</p>	<p><b>Live End Feed Connector</b></p> <p>Feed trac from above with flexible conduit, BX, etc., or end feed in pendant systems. Accepts standard 1/2" connector.</p> 	<p><b>Live End Feed Connector</b></p> <p>Same as R38 except designed for use in opposite polarity orientation compared to standard feed connectors.</p>

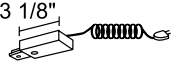
R22	R122
BL, BZ, SL, WH	BL, BZ, SL, WH
<p><b>Cord and Plug End Feed</b></p> <p>Comes with 15' two-wire white cord. Includes surface wire retainers and in-line switch. Max cap. 7 amps. Not UL Listed.</p> 	<p><b>Cord and Plug End Feed</b></p> <p>Same as R122 but with matching color 3-wire grounded cord and plug. No switch. Not UL Listed.</p>

# TRAC-LITES

One Circuit Trac System



## TRAC SECTIONS & SYSTEM COMPONENTS

### R Series

#### Trac Joiners & Dead End

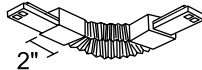
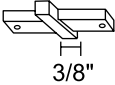
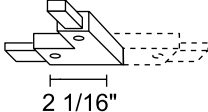
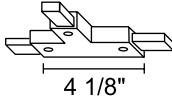
Examples: R20 BL, R25 RP WH

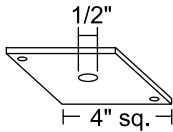
R20 BL, BZ, SL, WH	R23 BL, BZ, SL, WH	R24 ‡ BL, BZ, SL, WH	R25 ‡ BL, BZ, SL, WH	R25 RP ‡ BL, BZ, SL, WH
<p><b>Accordion Adjustable Joiner</b></p> <p>Can flex to 90° angle to left, right, up or down. Joins two trac sections.</p> 	<p><b>Miniature Straight Connector</b></p> <p>Joins two trac sections end to end.</p> 	<p><b>Adjustable Connector</b></p> <p>Joins two trac sections to make a 90° angle or straight run. Straight and right angle covers supplied. For outlet box feed, No. T27 cover plate required.</p> 	<p><b>"T" Connector</b></p> <p>Joins three trac sections. For outlet box feed, No. T27 cover plate required.</p> 	<p><b>"T" Connector</b></p> <p>Same as R25 except designed for use in opposite polarity orientation compared to standard feed connectors.</p>

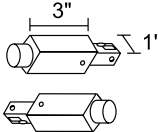
T27 BL, BZ, SL, WH	R28 BL, BZ, SL, WH	R49 BL, BZ, SL, WH
<p><b>Outlet Box Cover</b></p> <p>Use with Nos. R24/R25 for outlet box electrical feed. Includes: nipple, locknut and ground screw.</p> 	<p><b>Trac Dead End</b></p> <p>For use with field-cut trac sections.</p> 	<p><b>Trac Continuation Kit</b></p> <p>Permits trac to continue a run around obstructions. Includes one R34 Conduit Feed and one R34 RP Conduit Feed. Fits standard 1/2" conduit.</p> 

‡ R24 and R25 may not be used as feed connectors in Canada due to special grounding requirements.

# TRAC-LITES





One Circuit Trac System

## TRAC SECTIONS & SYSTEM COMPONENTS R Series

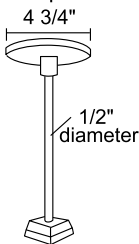
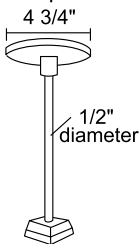
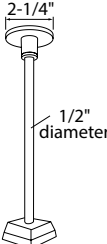
### Pendant Stems

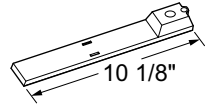
Examples: T90 12IN BL, T93 BL

T90	T91	T9091M
12IN, 18IN, 24IN, 36IN, 48IN	12IN, 18IN, 24IN, 36IN, 48IN	12IN, 18IN, 24IN, 36IN, 48IN
BL, BZ, SL, WH	BL, BZ, SL, WH	BL, SL, WH
<p><b>T-Bar Pendant Stem Kit</b></p> <p>Compatible with 15/16" flush T-Bar ceilings. Use two for 2', 4', 6' of trac or three for 8' of trac. Includes canopy, T-Bar mounting plate, stem and trac attachment hardware. For electrical feed, order <b>T93</b> wireway cover.</p> 	<p><b>Rigid Ceiling Pendant Stem Kit</b></p> <p>Attaches directly to junction box in rigid ceilings. Use two for 2', 4', 6' of trac or three for 8' of trac. Includes canopy, J-Box mounting strap, stem and trac attachment hardware. For electrical feed, order <b>T93</b> wireway cover.</p> 	<p><b>Pendant Stem Mechanical Support Kit</b></p> <p>For mechanical support only (no feed). Suspends Trac from T-bar or rigid ceilings. Use two for 2', 4', 6' of trac or three for 8' of trac or four for 12' of trac (support is required every 4 feet). Includes Mini-Canopy, pendant stem, 15/16" T-bar clip, drywall anchor and Trac mounting hardware.</p> 

T93	T94	T96	T56
BL, BZ, SL, WH	BL, BZ, SL, WH	BL, SL, WH	BL, SL, WH
<p><b>Wireway Cover</b></p> <p>For Pendant Stem Kits <b>T90</b> and <b>T91</b>. Conceals electrical feed wires from stem to connector. One cover required for each trac feed.</p> 	<p><b>Sloped Ceiling Adapter</b></p> <p>Allows <b>T90</b> or <b>T91</b> pendant to hang straight down from sloped ceilings. Can be used to feed electrical wires to Trac at up to 60° angle.</p> 	<p><b>Pendant Stem Threaded Coupling</b></p> <p>Enables multiple pendant stems to be joined for higher ceiling applications.</p> 	<p><b>Solid Rod Pendant Mounting Kit</b></p> <p>Attaches solid 5/16" threaded rod to Trac. Includes: plastic cap, mounting bracket and hardware. Rod not supplied.</p> 

# TRAC-LITES

One Circuit Trac System

## TRAC SECTIONS & SYSTEM COMPONENTS R Series

### Cable Suspension

Examples: T595 48IN BL, T598 144IN WH

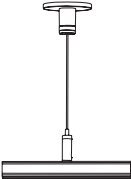
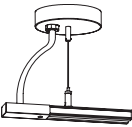
T595	T597	T596	T598
48IN, 144IN	48IN, 144IN	48IN, 144IN	48IN, 144IN
BL, WH	BL, WH	BL, WH	BL, WH
<p><b>T-Bar Ceiling Cable Suspension Kit</b></p> <p>Mechanical-only cable suspension kit for 1-circuit or 2-circuit trac. Compatible with 15/16" flush T-Bar ceilings. Adjustable 48" or 144" stainless steel cable length. Includes mini-canopy, T-bar clip and cable hardware. Trac requires support every 4'.</p> 	<p><b>Rigid Ceiling Cable Suspension Kit</b></p> <p>Mechanical-only cable suspension kit for 1-circuit or 2-circuit trac. Attaches directly to junction box in rigid ceilings. Adjustable 48" or 144" stainless steel cable length. Includes mini-canopy, toggle bolt and cable hardware. Trac requires support every 4'.</p>	<p><b>T-Bar Ceiling Cable Suspension/Feed Kit</b></p> <p>Cable suspension kit with adjustable 48" or 144" electrical feed cable for 1-circuit trac. Compatible with 15/16" flush T-Bar ceilings. Includes canopy, T-bar clip, mounting plate, cable hardware and flexible electrical feed cable. Trac feed connector not included (order separately). Trac requires support every 4'.</p> 	<p><b>Rigid Ceiling Cable Suspension/Feed Kit</b></p> <p>Cable suspension kit with adjustable 48" or 144" electrical feed cable for 1-circuit trac. Attaches directly to junction box in rigid ceilings. Includes canopy, J-box mounting strap, cable hardware and flexible electrical feed cable. Trac feed connector not included (order separately). Trac requires support every 4'.</p>



**Note:** Cable suspension is recommended for pattern installations only, or those installations that are supplemented with additional rigid mounting points (stems, threaded rod, etc.).

### Accessories

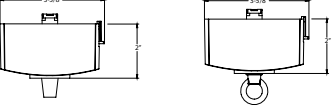
Example: T31N BL

R37F	R37D	R37916	T31N
			BL, SL, WH
<p><b>15/16" T-Bar Attachment Clip</b></p> <p>To attach to inverted tee ceilings using flush tiles. Use two for 2' or 4' trac and three for 6' or 8' trac.</p>	<p><b>15/16" T-Bar Attachment Clip</b></p> <p>Same as R37F with spacer for ceilings using drop tiles.</p> 	<p><b>9/16" T-Bar Attachment Clip</b></p> <p>To attach to inverted tee ceilings using flush or drop tiles. Use two for 2' or 4' trac and three for 6' or 8' trac.</p>	<p><b>Pendant Adapter</b></p> <p>Adapts corded, swag or chain-hung fixture to trac. Includes loop hook for chain installation and strain relief for direct cord suspension. Chain installation accepts cord diameters up to 0.270" and supports up to 15 lbs. Strain relief installation accepts cord diameters of 0.170" to 0.255", type SVT 18/3, and supports up to 5 lbs. May also be specified with GTYPE, HTYPE or LTYPE Alternate Mounting Adapters (i.e. T31N HTYPE WH). 5A max. UL Listed.</p> 

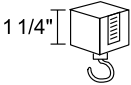
**Note:** GTYPE, HTYPE and LTYPE available in BL or WH finishes only.

T32	T33
BL, WH	BL, SL, WH
<p><b>Plant or Utility Hook</b></p> <p>Supports up to 25 lbs. Not UL Listed.</p> 	<p><b>Outlet Adapter</b></p> <p>Provides electrical receptacle. Not UL Listed.</p> 

# TRAC-LITES

One Circuit Trac System

## TRAC SECTIONS & SYSTEM COMPONENTS

### R Series

#### Example Trac Configurations & Recommended Components (Top Plan View)

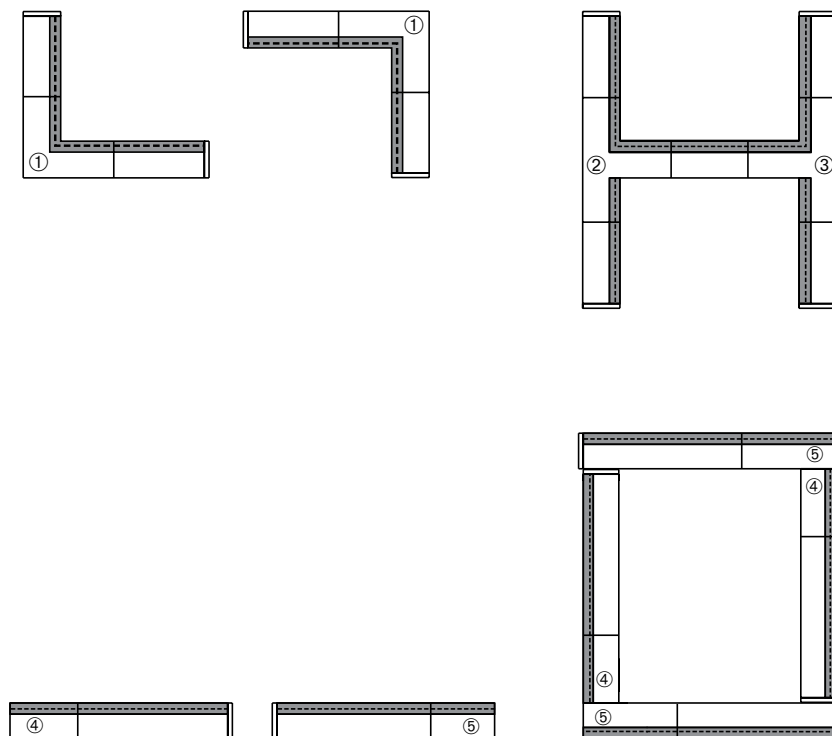

- ① Standard "L" Connector – **R24**
- ② Standard "T" Connector – **R25**
- ③ Reverse Polarity "T" Connector – **R25 RP**
- ④ Standard End Feed Connector – **R38** (or similar End Feed)
- ⑤ Reverse Polarity End Feed Connector – **R38 RP** (or similar Reverse Polarity End Feed)

(Each run controlled by separate feeds)