

SANI-LAV[®] COLUMBIA PRODUCTS

Operating Manual for 2-Person Hands-Free Floor Mount Stainless Steel Wash Station

Models 54FSL and 54FSL-0.5

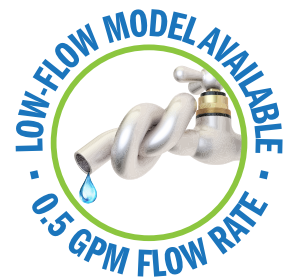

Columbia does not recommend use with harsh chemicals.

Product Compliance

NSF/ANSI 2 Food Equipment, NSF/ANSI 372 Low-Lead



Parts List

- (1) Floor mount wash station
- (1) Leg assembly set
- (6) Nuts, bolts and washers for leg assembly
- (4) Washers and nuts for connection sink to leg assembly set
- (2) Double foot pedal valve
- (4) Valve mounting nuts
- (2) Swivel gooseneck spout with aerator
- (2) Connecting tube for valve to spout connection
- (4) Fittings, brass, 0.375" male compression and 0.375" male NPT
- (1) Strainer assembly with basket

Tools Required

- Tape measure
- Adjustable wrench
- Drill motor and drill bits
- Pipe wrench
- Level
- Safety glasses
- Screw drivers: phillips and standard
- Pencil
- Socket wrench

Installation Instructions

Step 1

1. 2 and 3-Person models require leg assembly.
2. Place wash station sink on leg assembly and secure with hardware (provided).
3. Establish sink location.
4. Mark the floor where the four holes are at the base as shown in illustration A.
5. Drill holes as required for mounting hardware. (Hardware not included).

Step 2

1. Install spout assembly to the sink.
2. Install elbow fitting (provided) to the spout assembly.
3. Connect one side of the supply line (provided) to the spout assembly.
4. Install strainer assembly.

Step 3

1. Install elbow fitting to valve.
2. Install foot pedal valves under the leg assembly cross bar if not mounted already.
3. Attach connecting tube from the spout to the foot pedal valve.

Step 4

1. Secure wash station to the floor.
2. Connect waste line to strainer assembly.
3. Connect water supplies (hot and cold) to valves.

Step 5

1. Remove aerator from the spout assembly and flush water line by pressing pedal for 30 seconds.
2. Check connections for leaks. Replace aerator onto the spout assembly.
3. Seal gap between bowl and leg assembly as shown in illustration B.
4. When mounting against wall, we recommend sealing top of backsplash to wall as shown in illustration C.

Go to columbiasinks.com for more information on replacement parts and installation videos.



Illustration A

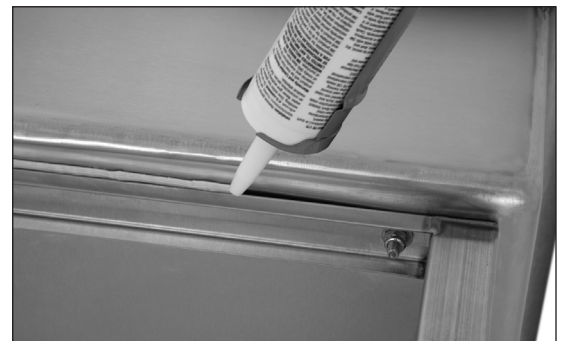

Illustration B



Illustration C

Notice for California Consumers

WARNING: This product can expose you to chemicals including Chromium (hexavalent compounds), Lead, and Phthalates (DEHP) which are known to the State of California to cause cancer and birth defects or other reproductive harm. For more information go to www.P65Warnings.ca.gov.

NOTE: Lead content originates from Brass components in valves and faucets and is certified under NSF/ANSI 372 as containing less than 0.25% lead in wetted surfaces.

Trouble Shooting Guide

Problem	Possible Cause	To Diagnose	Remedy
Water drips from spout or valve stem assembly.	Flat washer on the stem/plunger is worn.	To determine if the leak source is from the hot or cold side shut cold water source off. See if water still leaks from the spout. If leak continues then repair hot side if not repair cold side.	We recommend installing valve repair kit.
Water leaks from the front of the valve.	O-Rings on the plunger are worn out.	Visually determine whether the cold or hot side is leaking.	We recommend replacing threaded insert, plunger assembly & spring. See illustrations below.

Valve Repair Instructions

Note: Valves are designed to be repaired without having to be disconnected from mount or plumbing.

1. Turn off water source. Do not remove valve from sink.
2. Remove pedal assembly using a 15/16" open end wrench or socket wrench. As shown in illustration A.
3. Using a 1" deep socket wrench remove insert assembly parts as show in illustration B.
4. Replace with new repair kit as shown on illustration C.
5. Reinstall pedal assembly and turn water source on.

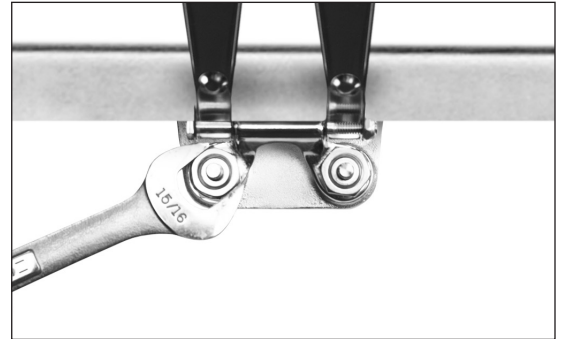

Illustration A

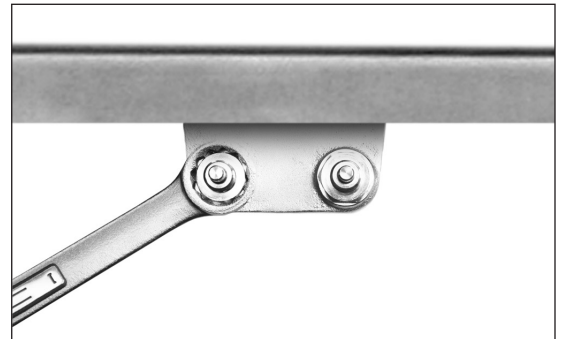

Illustration B

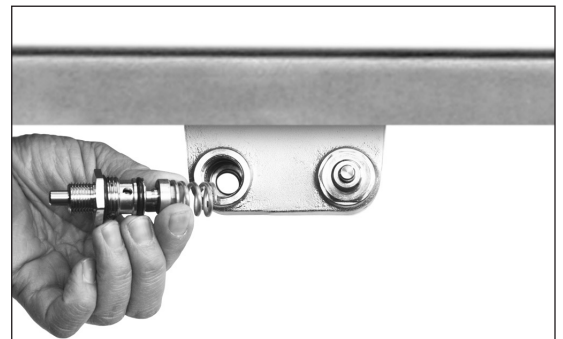
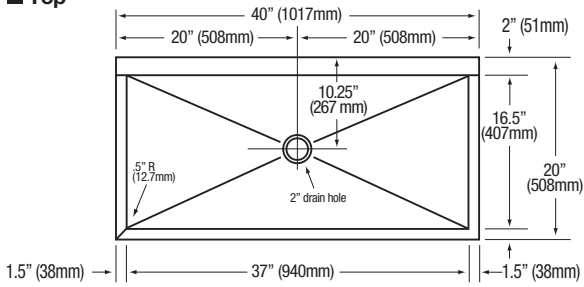
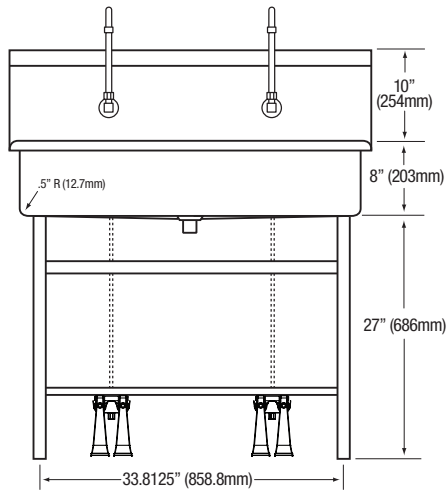

Illustration C

■ Top



■ Front



■ Side

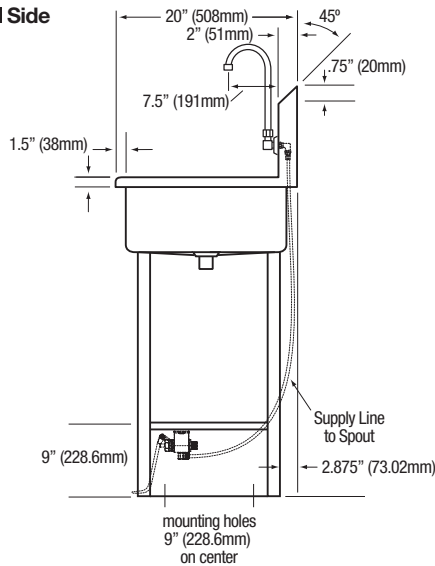

■ Hole Configurations

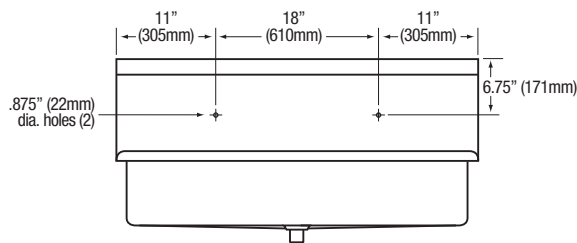

■ Floor Mounting Detail

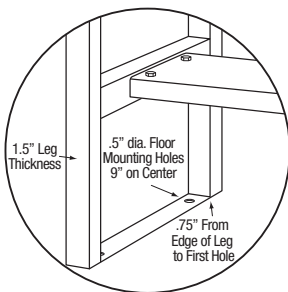

■ Plumbing Detail

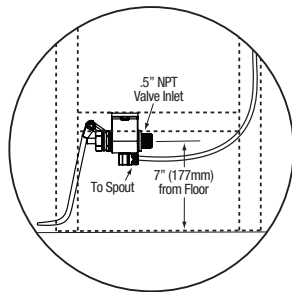

■ Supply Line Detail

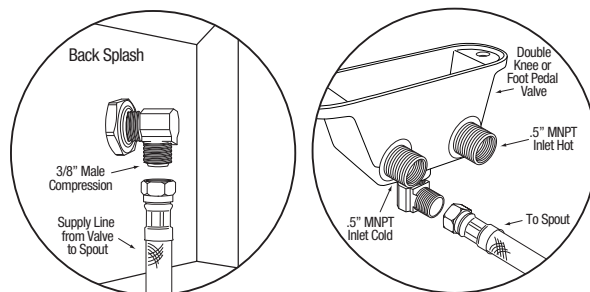

Leg Assembly

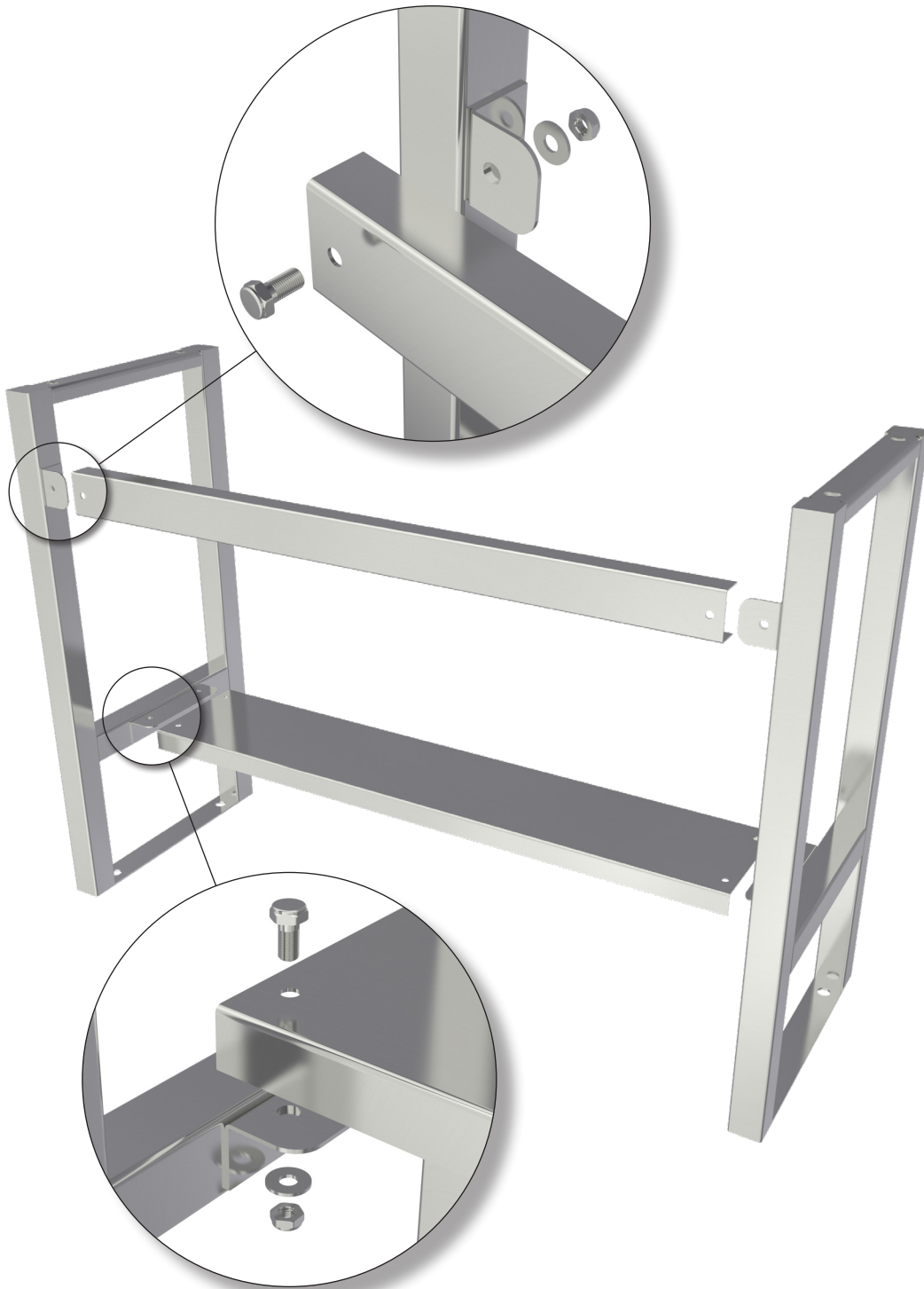
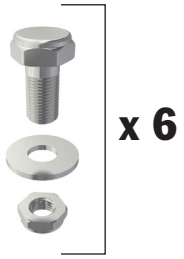

Replacement Parts

Part No.	Description	Application
A 1041	Operated, Long Foot	103/104/105/106 (S) (L)
B 1042	Operated, Short Foot	101/102 (S) (L)
C 1043	Operated, Knee	109/110/111/112 (S) (L)
D 1049	Bolt & Nut Set (Stainless)	All Single Valves
E 1050	Jam Nut (Stainless)	All Valves
F 1051	Bolt & Nut Set (Stainless)	All Double Valves
G 1052	Bracket	All Double Valves
H 1053	Threaded Insert (Low Lead)	All Valves
I 1053S	Threaded Insert (Stainless)	All Valves
J 1054	Bracket	All Single Valves
K 1055	Plunger Assembly (Low Lead)	All Valves
L 1055S	Plunger Assembly (Stainless)	All Valves
M 1056	Spring (Stainless)	All Valves
N 1057	Body only, Double Valve (Low Lead)	All Double Valves
O 1058	Body only, Single Valve	All Single Valves
P 1061L	Replacement Kit (Low Lead)	All Valves
Q 1061S	Replacement Kit (Stainless)	All Valves

Double Knee or Foot Pedal

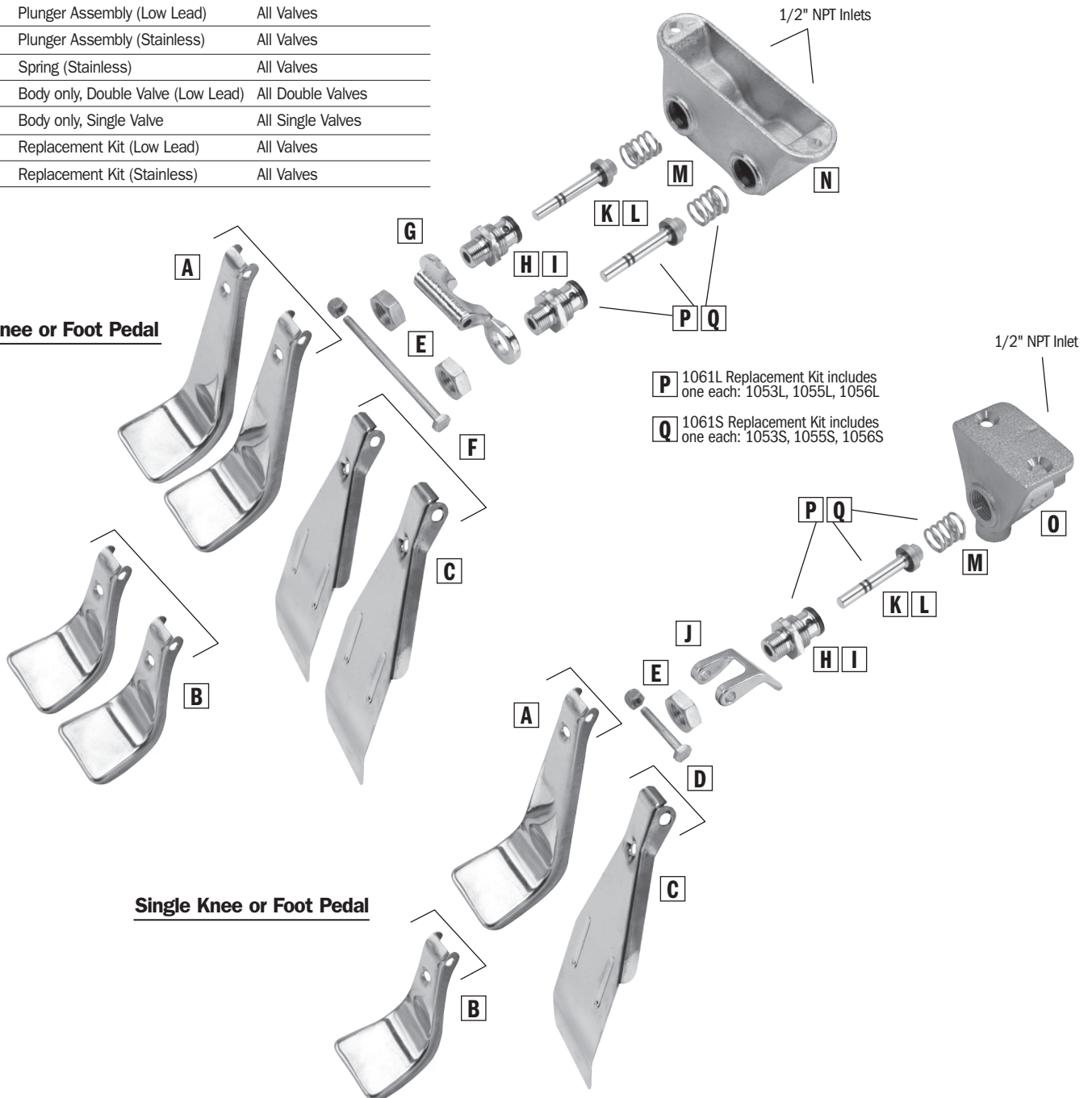

Single Knee or Foot Pedal

P 1061L Replacement Kit includes one each: 1053L, 1055L, 1056L
Q 1061S Replacement Kit includes one each: 1053S, 1055S, 1056S

Care and Maintenance

Regular cleaning will preserve the appearance and integrity of the surface. Stainless steel can easily be cleaned and kept stain-free using various methods.

Recommendations:

- Clean with an abrasive cleaner like, Bon-Ami or Zud weekly or bi-weekly. Always scrub in the direction of the grain or polish lines. Another option is to use Baking soda. Make sure to rinse well and dry. Illustration A
- Most soaps and detergents contain chlorides, we recommend rinsing the stainless-steel sink with hot water after use, to prevent corrosion. Illustration B
- Regularly dry your sink to prevent water and surface rust marks. Illustration C
- Do not leave salt in the sink or near a saltwater environment.
- Use a quality stainless steel cleaner and follow cleaner instructions. Wipe along the grain (NOT against). Illustration D

Things to Avoid:

- Avoid harsh abrasive cleaners and corrosive chemicals.
- Avoid abrasive scouring pads, carbon steel brushes and steel wool for cleaning as iron particles left behind can lead to rust.
- Avoid the use of oily rags or greasy cloths when wiping the surface. To avoid water spots, wipe dry after use.

Additional Tips:

- Regularly drying your sink works wonders to prevent water and surface rust marks.
- Wear rubber gloves when working with cleaners to protect your hands.
- Never mix cleaners. Some products react to create dangerous gases.
- There are thousands of blended or compound cleaners on the market. Users are advised to contact suppliers of solvents for information on their applications on stainless steel.
- DO NOT USE SOLVENTS in closed spaces or while smoking.
- Note: Columbia does not recommend use with harsh chemicals.



Illustration A



Illustration B



Illustration C

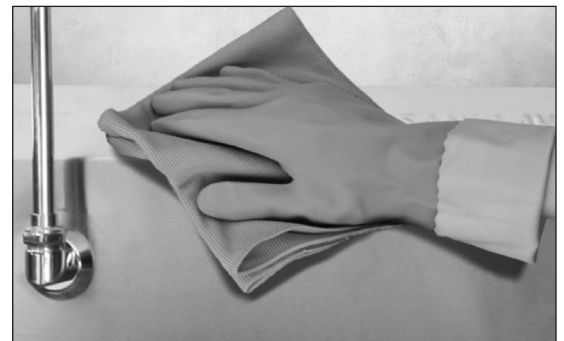

Illustration D