



Accessories for Surface Modification



For More Information...

For more information on our Accessories offering, visit [**3M.com/AccessoriesASD**](http://3M.com/AccessoriesASD)

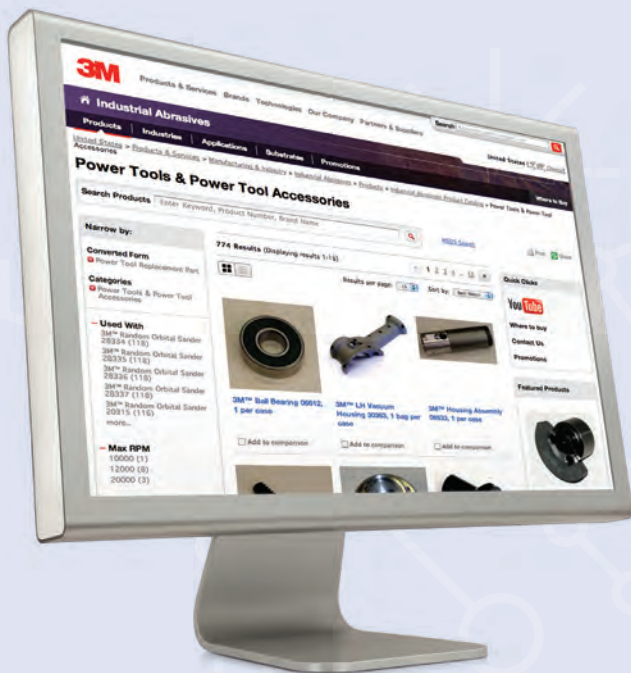



For more information about our 3M™ Power Tool replacement parts, visit [**3M.com/SpareParts**](http://3M.com/SpareParts)

Table of Contents

| | | | |
|--|--------------|---|--------------|
| Power Tool Accessories | 2–14 | 3M™ Finesse-it™ Compounds, Polishes and Pads | 41–47 |
| 3M™ Air Line Extensions & Air Tool Lubricants | 2 | 3M™ Finesse-it™ Compounds and Polishes | 41–42 |
| 3M™ Dual Lock™ Rubber Skirts | 2 | 3M™ Finesse-it™ Disc & Buffing Pads | 42–44 |
| 3M™ Dual Lock™ Disc Pad | 3 | 3M™ Perfect-it™ II Wool Compounding Pad | 44 |
| 3M™ Electric Random Orbital Sander Accessories | 3 | 3M™ Buffing and Polishing Accessories | 45 |
| 3M™ Filter Bags and Adapters | 3 | Scotch-Brite™ High Performance Cloth | 45 |
| 3M™ File Belt Sander Accessories | 4 | 3M™ Finesse-it™ Hand Sanding Pads | 46 |
| 3M™ File Belt Arm Service Tool Kit & Repair Kits | 5 | 3M™ Finesse-it™ Roloc™ Backup Pads | 46 |
| 3M™ Orbital/Random Orbital Sander Grips | 5 | 3M™ Hookit™ Polishing Pads | 47 |
| 3M™ 28391 Polisher Carbon Brush 120V | 5 | 3M™ Marine Products | 47–50 |
| 3M™ Tool Hangers | 6 | 3M™ Flanges | 51 |
| 3M™ Random Orbital Sander Muffler Kit | 6 | 3M™ RX Hub and Roto Peen Assembly | 51 |
| 3M™ Orbital/Random Orbital Sander Drop In Motors | 6–7 | 3M™ Flap Disc Adapter Nut and Holder | 52 |
| 3M™ Collets for 3M™ Disc Sanders & Die Grinders | 8 | 3M™ Flexible Grinding Wheel Backup Pads | 52 |
| 3M™ Elite Random Orbital Sander Wet Sanding Shroud Kit | 8 | Hand Pads, Blocks and Pad Holders | 53–60 |
| 3M™ Flanges | 9 | 3M™ Center Water Feed Disc Hand Pads | 53 |
| 3M™ Power Tool Flange Nuts & Handles | 9 | 3M™ Wetordry™ Bucket | 53 |
| 3M™ Service Tool Kit | 10 | 3M™ Rubber Sanding Blocks | 53 |
| 3M™ Wrenches for Power Tools | 10–11 | Pad Holders | 54 |
| 3M™ Bearing Puller | 11 | 3M™ Hookit™ Hand Pads and Blocks | 54–55 |
| 3M™ Service Tools — T-7 Soft Collar | 11 | 3M™ Dust Free Hand Pads and Blocks | 56 |
| 3M™ Vacuum Hose and Accessories | 12–13 | 3M™ Fairing and Hand File Boards | 56 |
| 3M™ Type 27 Grinder Guards | 13 | Air File Shoes | 57 |
| 3M™ Power Tool Overhose Kit and Sleeve | 13 | 3M™ Facing Material Rolls | 57 |
| 3M™ Roloc™ Dust Shroud Kits and Accessories | 14 | 3M™ Stikit™ Hand Pads and Blocks | 58–59 |
| Adapters, Mandrels, Cutters | 14–15 | 3M™ Screen Cloth Hand Pads | 60 |
| 3M™ Adapters | 14–15 | Mandrel and Spindles | 60–62 |
| 3M™ Bristle Disc Adapters | 15 | 3M™ Cartridge Roll Mandrels | 60 |
| 3M™ Bristle Disc Mandrel | 15 | 3M™ Forked Spindle | 61 |
| 3M™ SR Rotary Cutter | 15 | 3M™ Mandrels | 61 |
| Disc Pads and Holders | 16–40 | 3M™ Roloc™ Mandrel TS/TSM | 61 |
| 3M™ Disc Pad Face Plates | 16–17 | 3M™ Square/Cross Pad Mandrel | 61 |
| 3M™ Disc Pad Hubs | 18 | 3M™ Star Mandrel | 61 |
| 3M™ Disc Retainer Nuts | 19 | 3M™ Unitized Wheel Mandrels | 62 |
| 3M™ Fibre Disc Backup Pads | 19 | 3M™ Platen Pad Cover | 62 |
| Disc Pad Holders (Hook-and-Loop) | 20–22 | 3M™ Roto Peen Accessories | 63 |
| 3M™ Hookit™ Disc Pads & D/F Disc Pads | 22–25 | Molding Adhesive and Stripe Removal | 63 |
| 3M™ Hookit™ Roloc™ Disc Pads | 25 | 3M™ Rubber Cushion Polishing Wheels | 64 |
| 3M™ Roloc™ PSA Disc Pad | 25 | 3M™ Rubber Slotted Expander Wheels | 65 |
| 3M™ Hookit™ Clean Sanding Disc Pads & Pads | 26–27 | 3M™ Wetordry™ Rubber Squeegees | 65 |
| 3M™ Hookit™ Clean Sanding Pad Hook Saver | 27 | 3M™ All Purpose Tack Cloth | 66 |
| 3M™ Hookit™ Soft Interface Disc Pad | 27 | Power Tool Conversion Replacement Parts | 66–67 |
| 3M™ Hookit™ Clean Sanding Interface Pads | 28 | UPC Index | 68–70 |
| 3M™ Hookit™ Clean Sanding Disc Pad Hook Savers | 28 | Part Number Index | 71–72 |
| 3M™ Hook-and-Loop Conversion Face | 28 | | |
| 3M™ Random Orbital Sander 5" & 6" Backup Pads | 29 | | |
| 3M™ Stikit™ D/F Disc Pads (Vacuum) | 30 | | |
| 3M™ Stikit™ Disc Pads & Pads | 31–32 | | |
| 3M™ Stikit™ D/F Pad | 32 | | |
| 3M™ Stikit™ Soft Interface Disc Pad | 32 | | |
| 3M™ Stikit™ Dispensers | 32 | | |
| 3M™ PSA Disc Holders | 33 | | |
| 3M™ Roloc™ Shanks | 34 | | |
| 3M™ Roloc™ Disc Pads & Assemblies | 35–39 | | |
| 3M™ Roloc™ Cool Running Disc Pads | 39 | | |
| 3M™ Break Hub Cleaning | 40 | | |
| 3M™ Roloc™+ Buttons and Holders | 40 | | |
| Dressing and Shaping Tape | 40 | | |



3M™ Air Line Extensions

Shorter lengths of 3/8" ID air line that moves the quick disconnect couplings away from the tool and exhaust assembly. The 1/4" NPT fitting attaches directly to the Random Orbital Sander with Self-Generating or Central Vacuum.

| Product Name | UPC | Part No. | Description | Size | Air Inlet Thread | MOQ | |
|---|---|----------------|-------------|--|------------------|--------------|----|
| 3M™ Random Orbital Sander Mini Air Line Extension |  | 051141-25119-6 | 25119 | • 5" long air line moves coupling connection away from exhaust tube | 3/8" ID x 5" L | 1/4" NPT | 10 |
| 3M™ Random Orbital Sander Air Line Extension |  | 051141-20209-9 | 20209 | • Moves connection away from the exhaust tube and its 4-foot long extension safely keeps the couplings from hitting the work piece | 3/8" ID x 4' L | 1/4" NPT | 1 |
| 3M™ Swivel Quick Change Connector |  | 051141-55180-7 | 55180 | • Swivel quick disconnect air fitting • Swivels to allow air hose to be moved away from the filter bag | — | 1/4" NPT EXT | 1 |

3M™ Air Tool and Compressor Lubricants

A lubricating oil that keeps the tools running at top efficiency. The oil reduces the coefficient of friction between moving parts and reduces the amount of heat produced by the motor. Durable for air compressors.

| Product Name | UPC | Part No. | Description | Size | MOQ | |
|---------------------------------------|---|-----------------|-------------|---------------------------------|-------------------|----|
| 3M™ Air Tool and Compressor Lubricant |  | 051141-20466-6* | 20466 | For Power Tools Air Compressors | Quart | 12 |
| 3M™ Air Tool and Compressor Lubricant |  | 051141-20467-3* | 20467 | Larger size for Air Compressors | Gallon | 4 |
| 3M™ Air Tool Lubricant |  | 051141-20451-2 | 20451 | For Power Tools | 4 fl. oz. (188mL) | 12 |

*Make to order. Ships within 4 days.

Four Ball Wear Test (ASTM D-4172)

The Four Ball Wear Test determines the wear protection properties of a lubricant. Three metal balls are clamped together and covered with the test lubricant, while a rotating fourth ball is pressed against them in sliding contact. This contact typically produces a wear scar, which is measured and recorded. The smaller the average wear scar, the better the wear protection provided by the lubricant.

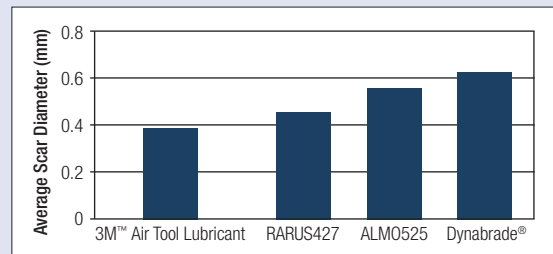

3M™ Dual Lock™ Rubber Skirts

Attaches to 3M™ Nib Removal Sander (PN03125) with existing four screws. Used in applications where a more durable attachment is needed to secure backup pad.





| Product Name | UPC | Part No. | Diameter | Max RPM | MOQ | |
|-----------------------------|---|----------------|----------|---------|-------|----|
| 3M™ Dual Lock™ Rubber Skirt |  | 051141-20246-4 | 20246 | 1-1/4" | 7,500 | 10 |

3M™ Dual Lock™ Disc Pad

This disc pad attaches to the 3M™ Dual Lock™ Rubber Skirt (PN20246). The Dual Lock™ Hooks provide a secure attachment even in extreme wet applications. The pad has a blue vinyl face to hold the PSA backed 3M™ Trizact™ Finesse-it™ Film Disc 466LA.



| Product Name | UPC | Part No. | Diameter | Density | Max RPM | MOQ | |
|----------------------------------|---|----------------|----------|---------|---------|-------|----|
| 3M™ Dual Lock™ PSA Soft Disc Pad |  | 051141-20247-1 | 20247 | 1-1/4" | Soft | 7,500 | 20 |

3M™ Electric Random Orbital Sander Accessories

| Product Name | UPC | Part No. | Description | MOQ | |
|-------------------------------------|---|----------------|-------------|--|---|
| 3M™ Power Cord |  | 051141-28434-7 | 28434 | <ul style="list-style-type: none"> • 12 ft. • 18 AWG Low Voltage • UL approved | 1 |
| |  | 051141-28435-4 | 28435 | <ul style="list-style-type: none"> • 24 ft. • Low Voltage • UL approved | 1 |
| 3M™ Power Supply with AC Power Cord |  | 051141-28436-1 | 28436 | <ul style="list-style-type: none"> • AC input 100–240 volt • Full Range, DC output 30 volt, 5 amp • Removable side bumpers and pre-drilled mounting flange • UL approved | 1 |
| 3M™ AC Power Cord |  | 051141-28478-1 | 28478 | <ul style="list-style-type: none"> • 6 ft. • Three Prong Power Cord • 110 volt • UL approved | 1 |

3M™ Filter Bags and Adapters

HEPA-rated filter dust collection bags and accessories used on Self Generating Vacuum Orbital and Random Orbital Sanders.

| Product Name | UPC | Part No. | Description | Size | MOQ | |
|--|---|----------------|-------------|--|----------------------------------|----|
| 3M™ Clean Sanding Filter Bag |  | 051141-20452-9 | 20452 | <ul style="list-style-type: none"> • Used on Random Orbital Sanders with Self-Generated Vacuum to collect dust • Eliminates the need for vacuum hose which improves operator ease of use • Attach bag to sander with 3M™ Filter Bag Adapter • HEPA-rated | Large — Holds up to 1/2 lb. | 50 |
| 3M™ Clean Sanding Filter Bag |  | 051141-28364-7 | 28364 | <ul style="list-style-type: none"> • Used on Random Orbital Sanders with Self-Generated Vacuum to collect dust • Use with 3M™ Clean Sanding Filter Bag Backpack Assembly which holds and protects the Filter Bag • HEPA-rated | Extra Large — Holds up to 3 lbs. | 20 |
| 3M™ Clean Sanding Filter Bag Backpack Assembly |  | 051141-28365-4 | 28365 | <ul style="list-style-type: none"> • Use as backpack or hip pack • Holds our 3M™ Extra Large Clean Sanding Filter Bag along with the other components used to connect the 3M™ Self-Generated Vacuum Random Orbital Sander to the Filter Bag | — | 1 |
| 3M™ Clean Sanding Filter Bag End Cap |  | 051141-28383-8 | 28383 | <ul style="list-style-type: none"> • Press onto the nozzle of the Filter Bag (PN20452 or PN28364) after the filter bag is full to keep dust from escaping • The order quantity of End Caps will be packaged in a poly bag and shipped in a best fit box | 1" ID | 1 |
| 3M™ Filter Bag Adapter |  | 051141-20453-6 | 20453 | <ul style="list-style-type: none"> • Used to attach 3M™ Clean Sanding Filter Bag to Self Generating Vacuum Orbital and Random Orbital Sanders • 1" EXT hose thread attaches to 3M™ Sander • 1" ID tubing attaches to 3M™ Clean Sanding Filter Bag | 1" EXT Hose Thread x 1" ID | 10 |
| 3M™ Hose Seal A0778 |  | 051115-28146-4 | 28146 | <ul style="list-style-type: none"> • Properly seals Self-Generated Vacuum exhaust swivel • Hose seal is standard on all Self-Generated Vacuum Orbital Sanders and Self-Generated Vacuum Random Orbital Sanders | 1" (28mm) | 1 |









3M™ File Belt Sander Accessories — Platen Pad Materials

3M™ Platen Pad materials provide support for abrasive belts. They can easily be trimmed to length and the PSA adhesive is easy for mounting. They are available in various hardnesses and thicknesses for a variety of sanding applications.

| Product Name | UPC | Part No. | Size | Thickness | Density | MOQ | |
|--|---|----------------|-------|---------------------|---------|------|----|
| 3M™ File Belt Sander Platen Pad Material |  | 051141-28381-4 | 28381 | 1/2" x 7" | 1/32" | Thin | 10 |
| | | 051141-28377-7 | 28377 | 1/2" x 7" | 1/8" | Soft | 10 |
| | | 051141-28379-1 | 28379 | 1/2" x 7" | 1/8" | Hard | 10 |
| | | 051141-28382-1 | 28382 | 3/4" x 7" | 1/32" | Thin | 10 |
| | | 051141-28378-4 | 28378 | 3/4" x 7" | 1/8" | Soft | 10 |
| | | 051141-28380-7 | 28380 | 3/4" x 7" | 1/8" | Hard | 10 |
| | | 051141-28726-3 | 28726 | 15-3/4" x 11-13/16" | 1/8" | Soft | 1 |

3M™ File Belt Sander Accessories — Attachment Arms

Attachment arms are for use with the 3M™ File Belt Sander and 3M™ Coated Abrasive and Scotch-Brite™ Belts.

| Product Name | UPC | Part No. | Description | MOQ | |
|-------------------------------------|---|----------------|-------------|--|---|
| 3M™ File Belt Sander Attachment Arm |  | 051141-28374-6 | 28374 | <ul style="list-style-type: none"> • Curved arm used for blending flat areas • Sand with contact wheel or platen • Use with 1/2" x 18" Coated Abrasive and Scotch-Brite belts | 1 |
| |  | 051141-28368-5 | 28368 | <ul style="list-style-type: none"> • Standard arm included with 3M™ File Belt Sander • Sand with contact wheel or platen • Use with 1/2" x 18" Coated Abrasive and Scotch-Brite belts | 1 |
| |  | 051141-28371-5 | 28371 | <ul style="list-style-type: none"> • Thick Standard • Sand with contact wheel or platen • Use with 5/8" or 3/4" x 18" Coated Abrasive and Scotch-Brite belts | 1 |
| |  | 051141-28369-2 | 28369 | <ul style="list-style-type: none"> • Thin — Thinner than standard arm • Sand with contact wheel or platen • Use with 1/2" x 18" Coated Abrasive and Scotch-Brite belts | 1 |
| |  | 051141-28375-3 | 28375 | <ul style="list-style-type: none"> • Vessel • Sand with contact wheel • Unique large arm used for blending weld seams • Use with 1/4" or 1/2" x 24" Coated Abrasive and Scotch-Brite belts • Includes tracking/control knob | 1 |
| |  | 051141-28376-0 | 28376 | <ul style="list-style-type: none"> • Extension used to extend arms to 24" length • Can be used with same attachment arms used for 18" length arms | 1 |
| |  | 051141-28370-8 | 28370 | <ul style="list-style-type: none"> • Sand corners and grooves with contact wheel • Use with 1/8", 1/4", or 1/2" x 18" Coated Abrasive and Scotch-Brite belts | 1 |
| |  | 051141-28372-2 | 28372 | <ul style="list-style-type: none"> • Sand corners and grooves with contact wheel • Use with 1/8" or 1/4" x 18" Coated Abrasive and Scotch-Brite belts | 1 |
| |  | 051141-28373-9 | 28373 | <ul style="list-style-type: none"> • 20-1/2" • Sand with contact wheel or platen • Use with 5/8" or 3/4" x 20-1/2" Coated Abrasive and Scotch-Brite belts | 1 |

3M™ File Belt Sander Accessories — Rubber Drive Pulley

| Product Name | UPC | Part No. | Description | MOQ | |
|---------------------------|---|----------------|-------------|---|---|
| 3M™ Drive Pulley — Rubber |  | 051141-30671-1 | 30671 | <ul style="list-style-type: none"> • Used to drive Scotch-Brite™ File Belts • Replacement drive pulley for 3M™ File Belt Sander | 1 |

3M™ File Belt Arm Service Tool Kit

This kit contains Wheel Positioning Block, Shaft Removal Tool, two Bearing Removal Tools, Bearing Mount Tool, Bearing Tool and Retaining Compound.

| Product Name | UPC | Part No. | MOQ |
|---|----------------|----------|-----|
|  3M™ File Belt Arm Service Tool Kit | 051141-30670-4 | 30670 | 1 |

3M™ File Belt Sander Attachment Arm Repair Kits







Kits contain: Contact wheel, bearings, shaft and platen pad if applicable. 3M™ File Belt Arm Service Tool Kit (PN30670) recommended for use with repair kits.

| Repair Kit Part No. | For Use with Arm Part No. |
|---------------------|---------------------------|
| 30662 | 28374 |
| 30663 | 28368 |
| 30664 | 28371 |
| 30667 | 28369 |

| Repair Kit Part No. | For Use with Arm Part No. |
|---------------------|---------------------------|
| 30669 | 28375 |
| 30668 | 28370 |
| 30666 | 28372 |
| 30665 | 28373 |

3M™ Random Orbital Sander Grips — Elite and Original Series





Three different size replacement grips allow the sander to be used by operators with larger or smaller hand sizes.

| Product Name | UPC | Part No. | Description | Diameter | MOQ | |
|--|---|----------------|-------------|--|--------|---|
| 3M™ Random Orbital Sander Grip — Elite Series |  | 051141-55204-0 | 55204 | • For small sized hands | 2-1/2" | 1 |
| |  | 051141-55205-7 | 55205 | • For medium sized hands • Standard size that comes on the tool | 2-3/4" | 1 |
| |  | 051141-55206-4 | 55206 | • For large sized hands | 3" | 1 |
| 3M™ Random Orbital Sander Grip — Original Series |  | 051141-20342-3 | 20342 | • For small sized hands | 2-1/2" | 1 |
| |  | 051141-20343-0 | 20343 | • For medium sized hands • Standard size that comes on the tool | 2-3/4" | 1 |
| |  | 051141-20344-7 | 20344 | • For large sized hands | 3" | 1 |
| 3M™ Grip |  | 051141-55146-3 | 55146 | • Replacement grip for 3M™ Electric Random Orbital Sander | 5"/6" | 1 |

3M™ 28391 Polisher Carbon Brush 120V

| Product Name | UPC | Part No. | Description | MOQ |
|---|----------------|----------|--|-----|
|  3M™ 28391 Polisher Carbon Brush 120V | 051141-30933-0 | 30933 | Replacement motor brushes for 3M™ Electric Variable Speed Polisher (model 28391) | 1 |

3M™ Tool Hangers

| Product Name | | UPC | Part No. | Description | MOQ |
|-------------------------|---|----------------|----------|--|-----|
| 3M™ Hanger |  | 051141-30331-4 | 30331 | <ul style="list-style-type: none"> Replacement part for 3M™ Abrasive Power Tools See Owners Manual for specific tool for Parts List and tool schematic | 1 |
| 3M™ Hanger 28737 |  | 051115-66905-7 | 66905 | <ul style="list-style-type: none"> Replacement part for 3M™ Elite Series Mini Orbital Sander (PN28737) | 1 |
| 3M™ Screw, Hanger 28737 |  | 051115-66906-4 | 66906 | <ul style="list-style-type: none"> Replacement part for 3M™ Elite Series Mini Orbital Sander (PN28737) | 1 |
| 3M™ Tool Hanger B0442 |  | 051141-28317-3 | 28317 | <ul style="list-style-type: none"> Attaches to all 3M™ Random Orbital Sanders and Buffers to be conveniently hung up on a hook for easy access | 1 |

3M™ Random Orbital Sander Muffler Kit

| Product Name | | UPC | Part No. | Description | MOQ |
|---------------------------------------|---|----------------|----------|--|-----|
| 3M™ Random Orbital Sander Muffler Kit |  | 051141-28394-4 | 28394 | <ul style="list-style-type: none"> Kit used for 3", 5" and 6" 3M™ Random Orbital Sanders Contains 1 each: internal muffler (PNA0062), muffler insert (PNA0068) and muffler housing (PNA0166) | 1 |





3M™ Orbital Sander Drop In Motors

Allows for very fast and easy repair of the 3M™ Orbital Sander. The complete motor is replaced instead of rebuilding the motor with individual parts.

| Product Name | | UPC | Part No. | Tool Size | Orbit Diameter | MOQ |
|----------------------------------|--|----------------|----------|-----------|----------------|-----|
| 3M™ Orbital Sander Drop In Motor |  | 051141-20223-5 | 20223 | 3" x 4" | 1/8" (3.2mm) | 1 |

3M™ Electric Random Orbital Sander Drop In Motors

Allows for very fast and easy repair of the 3M™ Electric Random Orbital Sander. The complete motor is replaced instead of rebuilding the motor with individual parts.

| Product Name | | UPC | Part No. | Tool Diameter | Orbit Diameter | MOQ |
|--|---|----------------|----------|---------------|----------------|-----|
| 3M™ Electric Random Orbital Sander Drop In Motor |  | 051141-55434-1 | 55434 | 5" (127mm) | 3/32" (2.5mm) | 1 |
| |  | 051141-55435-8 | 55435 | 5" (127mm) | 3/16" (5mm) | 1 |
| |  | 051141-55436-5 | 55436 | 6" (150mm) | 3/32" (2.5mm) | 1 |
| |  | 051141-55437-2 | 55437 | 6" (150mm) | 3/16" (5mm) | 1 |

3M™ Elite Random Orbital Sander Drop In Motors

Allows for very fast and easy repair of the 3M™ Elite Random Orbital Sander. The complete motor is replaced instead of rebuilding the motor with individual parts.





| Product Name | UPC | Part No. | Tool Diameter | Orbit Diameter | MOQ | |
|---|---|----------------|---------------|----------------|---------------|---|
| 3M™ Elite Random Orbital Sander Drop In Motor |  | 051141-28605-1 | 28605 | 3" (77mm) | 3/32" (2.5mm) | 1 |
| | | 051141-28606-8 | 28606 | 3" (77mm) | 3/16" (5mm) | 1 |
| | | 051141-28607-5 | 28607 | 5" (127mm) | 3/32" (2.5mm) | 1 |
| | | 051141-28608-2 | 28608 | 5" (127mm) | 3/16" (5mm) | 1 |
| | | 051141-28609-9 | 28609 | 5" (127mm) | 5/16" (8mm) | 1 |
| | | 051141-28610-5 | 28610 | 5" (127mm) | 3/8" (10mm) | 1 |
| | | 051141-28611-2 | 28611 | 6" (150mm) | 3/32" (2.5mm) | 1 |
| | | 051141-28612-9 | 28612 | 6" (150mm) | 3/16" (5mm) | 1 |
| | | 051141-28613-6 | 28613 | 6" (150mm) | 5/16" (8mm) | 1 |
| | | 051141-28614-3 | 28614 | 6" (150mm) | 3/8" (10mm) | 1 |

3M™ Random Orbital Sander Drop In Motors

Allows for fast and easy repair of 3M™ Random Orbital Sanders. The complete motor is replaced instead of rebuilding the motor with individual parts.

| Product Name | UPC | Part No. | Description | Tool Diameter | Orbit Diameter | MOQ | |
|--|---|----------------|-------------|--|----------------|---------------|---|
| 3M™ Mini Random Orbital Sander Drop In Motor |  | 051141-28318-0 | 28318 | • For 3M™ Mini Random Orbital Sander • 3/16" orbit | 1-1/4" (32mm) | 3/16" (5mm) | 1 |
| 3M™ Random Orbital Buffer Drop In Motor |  | 051141-30445-8 | 30445 | • For 3-inch 3M™ Random Orbital Buffer (PN28333) • 1/2" orbit | 3" (77mm) | 1/2" (12mm) | 1 |
| 3M™ Random Orbital Sander Drop In Motor |  | 051141-20216-7 | 20216 | • For 3-inch 3M™ Random Orbital Sander • 3/32" orbit | 3" (77mm) | 3/32" (2.5mm) | 1 |
| | | 051141-20217-4 | 20217 | • For 3-inch 3M™ Random Orbital Sander • 3/16" orbit | 3" (77mm) | 3/16" (5mm) | 1 |
| | | 051141-20218-1 | 20218 | • For 5-inch 3M™ Random Orbital Sander • 3/32" orbit | 5" (127mm) | 3/32" (2.5mm) | 1 |
| | | 051122-01811-4 | 01811 | • For 5-inch 3M™ Random Orbital Sander • 3/16" orbit | 5" (127mm) | 3/16" (5mm) | 1 |
| | | 051141-20256-3 | 20256 | • For 5-inch 3M™ Random Orbital Sander • 5/16" orbit | 5" (127mm) | 5/16" (8mm) | 1 |
| | | 051122-01812-1 | 01812 | • For 6-inch 3M™ Random Orbital Sander • 3/32" orbit | 6" (150mm) | 3/32" (2.5mm) | 1 |
| | | 051141-20221-1 | 20221 | • For 6-inch 3M™ Random Orbital Sander • 3/16" orbit | 6" (150mm) | 3/16" (5mm) | 1 |
| | | 051141-20222-8 | 20222 | • For 6-inch 3M™ Random Orbital Sander • 5/16" orbit | 6" (150mm) | 5/16" (8mm) | 1 |
| 3M™ Random Orbital Sander — Two-Hand Drop In Motor |  | 051141-30443-4 | 30443 | • For 3M™ Random Orbital Sander, 2-Hand • 3/36" orbit | 6" (150mm) | 3/16" (5mm) | 1 |
| | | 051141-30444-1 | 30444 | • For 3M™ Random Orbital Sander, 2-Hand • 3/8" orbit | 6" (150mm) | 3/8" (10mm) | 1 |

3M™ Collets for 3M™ Disc Sanders

| Product Name | | UPC | Part No. | Size | MOQ |
|--------------|---|----------------|----------|-------|-----|
| 3M™ Collet |  | 051115-06528-6 | 06528 | 1/4" | 1 |
| |  | 051115-06529-3 | 06529 | 1/8" | 1 |
| |  | 051115-06530-9 | 06530 | 3/16" | 1 |
| |  | 051115-06540-8 | 06540 | 3mm | 1 |
| |  | 051115-06541-5 | 06541 | 6mm | 1 |



3M™ Collets for 3M™ Die Grinders

| Product Name | | UPC | Part No. | Size | MOQ |
|-----------------------|---|----------------|----------|-------|-----|
| 3M™ Collet |  | 051115-06545-3 | 06545 | 3/8" | 1 |
| |  | 051115-06546-0 | 06546 | 8mm | 1 |
| |  | 051115-06573-6 | 06573 | 1/8" | 1 |
| |  | 051115-06574-3 | 06574 | 3/16" | 1 |
| |  | 051115-06575-0 | 06575 | 1/4" | 1 |
| |  | 051115-06576-7 | 06576 | 3mm | 1 |
| |  | 051115-06577-4 | 06577 | 6mm | 1 |
| 3M™ Collet for 0.3 HP |  | 051141-55772-4 | 55772 | 1/8" | 1 |
| |  | 051141-55752-6 | 55752 | 1/4" | 1 |





3M™ Elite Random Orbital Sander Wet Sanding Shroud Kit

| Product Name | | UPC | Part No. | Size | MOQ |
|--|---|----------------|----------|------|-----|
| 3M™ Elite Random Orbital Sander Wet Sanding Shroud Kit |  | 051141-28653-2 | 28653 | 5" | 1 |





3M™ Flanges

| Product Name | | UPC | Part No. | Size | Thread Size | MOQ |
|----------------|---|----------------|----------|-----------|-------------|-----|
| 3M™ Flange |  | 051141-55100-5 | 55100 | 1-1/4" | 3/8-24 INT | 1 |
| 3M™ Flange Nut |  | 051141-28739-3 | 28739 | 1" x 5/8" | 3/8-24 INT | 1 |
| |  | 051141-28740-9 | 28740 | 1" | 5/8-11 INT | 1 |

3M™ Power Tool Flange Nuts

| Product Name | | UPC | Part No. | Size | Thread Size | MOQ |
|-----------------------------|--|----------------|----------|---------|-------------|-----|
| 3M™ Retainer-Grinding Wheel |  | 051141-55082-4 | 55082 | — | 3/8-24 INT | 1 |
| 3M™ Wheel Retainer |  | 051115-06585-9 | 06585 | — | 3/8-24 INT | 1 |
| |  | 051115-06590-3 | 06590 | — | 5/8-11 INT | 1 |
| 3M™ Wheel Flange |  | 051141-55085-5 | 55085 | 3/8" AH | — | 1 |

3M™ Power Tool Handles

| Product Name | | UPC | Part No. | Size | Thread Size | MOQ |
|---------------------------|---|----------------|----------|-------------|-------------|-----|
| 3M™ Handle |  | 051141-30364-2 | 30364 | — | — | 1 |
| 3M™ Power Tool Handle Kit |  | 051141-28395-1 | 28395 | — | — | 1 |
| 3M™ Side Handle |  | 051141-28402-6 | 28402 | 1-1/2" x 6" | 3/8-16 EXT | 1 |
| |  | 051141-30334-5 | 30334 | — | M8 EXT | 1 |

3M™ Service Tool Kit

This kit contains all of the special tools needed to disassemble and reassemble 3M™ Orbital and Random Orbital Sanders.

| Product Name | UPC | Part No. | MOQ |
|----------------------|----------------|----------|-----|
| 3M™ Service Tool Kit | 051141-20215-0 | 20215 | 1 |



3M™ Wrenches for Power Tools

| Product Name | UPC | Part No. | Size | MOQ |
|---------------------------------|----------------|----------|----------------|-----|
| 3M™ 28391 Polisher Wrench | 051141-30948-4 | 30948 | 17mm | 1 |
| 3M™ 28737 L Shape Hex Wrench | 051115-66902-6 | 66902 | 2.0mm | 1 |
| | 051115-66901-9 | 66901 | 2.5mm | 1 |
| 3M™ 28631 Pad Wrench | 051141-55788-5 | 55788 | 13mm | 1 |
| 3M™ 3125 Clamp Nut Wrench ST041 | 051141-30831-9 | 30831 | — | 1 |
| 3M™ Adjustable Spanner Wrench | 051115-06544-6 | 06544 | — | 1 |
| 3M™ Hex Wrench | 051115-06610-8 | 06610 | 3/16" | 1 |
| 3M™ Hex Wrench A0864 | 051115-28147-1 | 28147 | 2.5mm | 1 |
| 3M™ Pad Wrench A0022 | 051115-28108-2 | 28108 | 24mm | 1 |
| 3M™ Wrench — Drive Wheel | 051141-30672-8 | 30672 | — | 1 |
| 3M™ Wrench | 051115-06522-4 | 06522 | 7/8" | 1 |
| | 051115-06524-8 | 06524 | 5/8" | 1 |
| | 051115-06569-9 | 06569 | 9/16" x 3/4" | 1 |
| | 051115-06586-6 | 06586 | 7/16" x 11/16" | 1 |
| 3M™ Wrench — open end | 051141-28725-6 | 28725* | 2-15/64" | 1 |
| | 051141-30437-3 | 30437 | 13/16" | 1 |

*For 3M™ Fibre Disc Pad Hubs

3M™ Wrenches for Power Tools (cont.)

| Product Name | | UPC | Part No. | Size | MOQ |
|--------------------------|---|----------------|----------|---------------------------|-----|
| 3M™ Wrench —L-Key |  | 051141-30673-5 | 30673 | 4.0mm | 1 |
| |  | 051141-30674-2 | 30674 | 2.5mm | 1 |
| 3M™ Wrench A0146 |  | 051115-28134-1 | 28134 | 17mm | 1 |
| 3M™ Spanner Wrench |  | 051141-55081-7 | 55081 | 1/8" Dia. x 21/32 B.C. | 1 |
| |  | 051141-55115-9 | 55115 | 1/8" Dia. x 1.25 B.C. | 1 |
| 3M™ T-6 Lock Ring Wrench |  | 051141-28320-3 | 28320 | — | 1 |

3M™ Bearing Puller

| Product Name | | UPC | Part No. | Size | MOQ |
|-------------------------------|--|----------------|----------|------|-----|
| 3M™ 3125 Bearing Puller ST501 |  | 051141-30832-6 | 30832 | — | 1 |

3M™ Service Tools — T-7 Soft Collar

| Product Name | | UPC | Part No. | Size | MOQ |
|---------------------|---|----------------|----------|------|-----|
| 3M™ T-7 Soft Collar |  | 051141-28319-7 | 28319 | — | 1 |

3M™ Vacuum Hose and Accessories

Allows different size vacuum hoses to be attached to Central Vacuum-ready sanders.

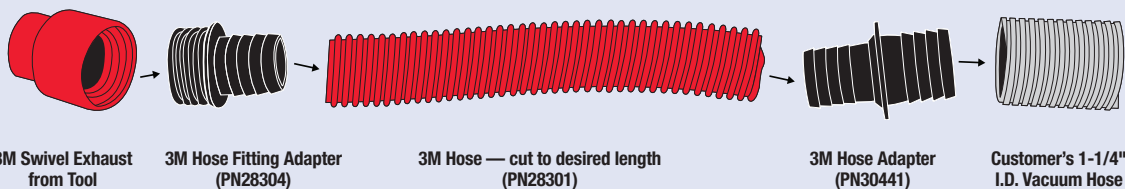

| Product Name | UPC | Part No. | Description | Size | MOQ |
|---------------------------------|----------------|----------|--|------------------------------|-----|
| 3M™ Vacuum Bag Cover | 051141-28303-6 | A1434 | <ul style="list-style-type: none"> • Holds and protects paper Vacuum Bag Insert (PN20338) • Black Cloth | 9" Wide 20" Long | 1 |
| 3M™ Vacuum Bag Inserts | 051141-20338-6 | 20338 | <ul style="list-style-type: none"> • Paper vacuum bag used to collect dust when using a SGV Orbital or ROS • Connects to 1" vacuum hose (PN28301) with adapter (PN28302) • Fits inside cloth bag cover (PNA1434) | 1" INT | 50 |
| 3M™ Vacuum Hose Adapter | 051141-28302-9 | 28302 | <ul style="list-style-type: none"> • Used to connect 1" External Hose Thread vacuum hose to paper vacuum bag and cloth cover bag | 1" INT | 1 |
| | 051141-30441-0 | 30441 | <ul style="list-style-type: none"> • Used to attach a 1" ID vacuum hose to a 1-1/4" ID vacuum hose • 1" friction fit barb pushes into ID of 1" vacuum hose • 1-1/4" friction fit barb pushes into ID of 1-1/4" vacuum hose | 1" Dia 1-1/4" OD | 1 |
| | 051141-30440-3 | 30440 | <ul style="list-style-type: none"> • Used to attach a 1" ID vacuum hose to a 1-1/2" ID hose • 1" friction fit barb pushes into ID of 1" hose • 1-1/2" friction fit barb pushes into ID of 1-1/2" hose | 1" Dia 1-1/2" OD | 1 |
| | 051141-30439-7 | 30439 | <ul style="list-style-type: none"> • Used to attach a 1" ID vacuum hose to a 2" ID hose • 1" friction fit barb pushes into ID of 1" hose • 2" friction fit barb pushes into ID of 2" hose | 1" Dia 2" OD | 1 |
| 3M™ Vacuum Hose End Adapter | 051141-30324-6 | 30324 | <ul style="list-style-type: none"> • Used to attach a 1" ID vacuum hose to a 3/4" ID hose • 1" internal hose thread in one end of the adapter; 3/4" internal hose thread in the other end | 3/4" INT 1" INT | 1 |
| | 051141-20340-9 | 20340 | <ul style="list-style-type: none"> • Used to attach a 1" threaded hose to a 1-1/4" threaded hose | 1" INT 1-1/4" INT | 1 |
| 3M™ Vacuum Hose Fitting Adapter | 051141-20341-6 | 20341 | <ul style="list-style-type: none"> • 1" INT hose thread x 1-1/2" OD Hose Adapter | 1-1/2" ID 1" INT | 1 |
| | 051141-28304-3 | 28304 | <ul style="list-style-type: none"> • Used to attach a 1" ID vacuum hose to 3M™ Random Orbital Sander • 1" vacuum hose external thread (left hand thread) screws into ROS exhaust assembly • 1" friction fit barb pushes into ID of the hose | 1" Dia 1" EXT | 1 |
| 3M™ Vacuum Hose Anti-Static | 051141-28730-0 | 28730 | <ul style="list-style-type: none"> • Black vacuum hose used to properly connect 3M™ Dust Shrouds, 3M™ Random Orbital and Orbital Sanders to a vacuum system for superb performance | 1" ID 4 ft Long 1" EXT | 1 |

How to Connect a Random Orbital Sander to a 1-1/4" Vacuum Hose







3M™ Vacuum Hose and Accessories (cont.)

Allows different size vacuum hoses to be attached to Central Vacuum-ready sanders.



| Product Name | UPC | Part No. | Description | Size | MOQ | |
|--------------------------------|---|----------------|-------------|---|-------------------------------|---|
| 3M™ Vacuum Hose |  | 051141-28301-2 | 28301 | <ul style="list-style-type: none"> Red vacuum hose used to properly connect 3M™ Random Orbital and Orbital Sanders to a vacuum system for superb performance | 1" ID 6 ft Long 1" EXT | 1 |
| |  | 051141-28393-7 | 28393 | <ul style="list-style-type: none"> Red vacuum hose used to properly connect 3M™ Random Orbital and Orbital Sanders to a vacuum system for superb performance | 1" ID 60 ft Long 1" EXT | 1 |
| 3M™ Vacuum Hose Swivel Adapter |  | 051141-30442-7 | 30442 | <ul style="list-style-type: none"> Used to attach a 1" ID vacuum hose to another 1" ID vacuum hose to create a longer vacuum hose 1" internal hose thread in both ends of the adapter | 1" INT x 1" INT | 1 |

3M™ Type 27 Grinder Guards





Replacement parts for 3M™ Right Angle Grinders and Sanders.

| Product Name | UPC | Part No. | Size | MOQ | |
|-------------------------------|--|----------------|-------|--------|---|
| 3M™ Type 27 Guard |  | 051141-55109-8 | 55109 | 4" | 1 |
| 3M™ Grinder Guard (flat back) |  | 051141-55106-7 | 55106 | 4-1/2" | 1 |
| 3M™ Type 27 Guard |  | 051141-55108-1 | 55108 | 4-1/2" | 1 |
| 3M™ Grinder Guard |  Photo Not Available | 051141-28632-7 | 28632 | 5" | 1 |

3M™ Power Tool Overhose Kit and Sleeve







| Product Name | UPC | Part No. | Description | Size | MOQ | |
|---------------------------------|---|----------------|-------------|---|---------------|---|
| 3M™ Overhose Kit |  | 051141-28651-8 | 28651 | <ul style="list-style-type: none"> For 0.3 HP Die Grinders Kit Contains: Air Line Extension (PN20209), Adapter (PN20453), Overhose Cloth Sleeve, Exhaust Spacer, Air Inlet Bushing and Instruction Sheet | — | 1 |
| 3M™ Overhose Replacement Sleeve |  | 051141-28652-5 | 28652 | <ul style="list-style-type: none"> Replaces the sleeve that comes in the Overhose Kit for 0.3 HP Die Grinders Zip tie allows it to be attached to the rubber adapter supplied with the kit Can also be used on 0.5 HP and 1 HP Die Grinders and Disc Sanders | 1-1/2" x 4 ft | 5 |

3M™ Roloc™ Dust Shroud Kits and Accessories

| Product Name | UPC | Part No. | Description | Size | MOQ | |
|-------------------------------|---|----------------|-------------|--|-----|---|
| 3M™ Roloc™ TR Dust Shroud Kit |  | 051141-28727-0 | 28727 | <ul style="list-style-type: none"> Converts a 3M™ Disc Sander (0.3 HP or 0.5 HP) into a vacuum Disc Sander Comes with a 2" Roloc™ TR Cool Running Disc Pad (PN82974) and an alignment jig for mounting the shroud onto the 3M Disc Sander For use with 3M™ Roloc™ D/F TR Discs TS/TSM Holder is also available | 2" | 1 |
| |  | 051141-28728-7 | 28728 | <ul style="list-style-type: none"> Converts a 3M™ Disc Sander (0.3 HP or 0.5 HP) into a vacuum Disc Sander Comes with a 3" Roloc™ TR Cool Running Disc Pad (PN82975) and an alignment jig for mounting the shroud onto the 3M Disc Sander For use with 3M™ Roloc™ D/F TR Discs TS/TSM Holder is also available | 3" | 1 |
| 3M™ Dust Shroud Clear Skirt |  | 051141-28743-0 | 28743 | <ul style="list-style-type: none"> Replaces the clear skirt that comes with the 2" Disc Sander Dust Shroud Kit (PN28727) after it has become worn or cloudy in appearance The worn skirt is easily removed and the new skirt snaps into the lip molded into the shroud | 2" | 5 |
| |  | 051141-28741-6 | 28741 | <ul style="list-style-type: none"> Replaces the clear skirt that comes with the 3" Disc Sander Dust Shroud Kit (PN28728) after it has become worn or cloudy in appearance The worn skirt is easily removed and the new skirt snaps into the lip molded into the shroud | 3" | 5 |



3M™ Adapters

Used to change the attachment style of a tool for use with common attachments used on accessories for abrasive disc products.



| Product Name | UPC | Part No. | Description | Thread Size | MOQ | |
|---------------------------|---|----------------|-------------|---|---------------------------|---|
| 3M™ Disc Holder Adapter 9 |  | 048011-22970-6 | 9 | <ul style="list-style-type: none"> Convert a sander with a 3/8–24 external threaded shaft to a 5/8–11 EXT threaded shaft Use with 5/8–11 disc holders | 5/8–11 EXT x 3/8–24 INT | 1 |
| |  | 048011-22971-3 | 9 | <ul style="list-style-type: none"> Convert a sander with an M10–1.25 EXT threaded shaft to a 5/8–11 EXT threaded shaft Use with 5/8–11 disc holders | 5/8–11 EXT x M10–1.25 INT | 1 |
| |  | 048011-22972-0 | 9 | <ul style="list-style-type: none"> Convert a sander with an M10–1.5 EXT threaded shaft to a 5/8–11 EXT threaded shaft Use with 5/8–11 disc holders | 5/8–11 EXT x M10–1.50 INT | 1 |
| 3M™ Wheel Adapter 81A |  | 051144-45081-7 | 45081 | <ul style="list-style-type: none"> Use with Type 81 and Type 84 PG Wheels 1/4" diameter shank and 1/4–20 INT thread to fit PG Wheels with 1/4–20 EXT threads | 1/4–20 INT | 1 |
| 3M™ Wheel Adapter Kit |  | 051141-28419-4 | 28419 | Kit contains: <ul style="list-style-type: none"> one spindle extension 5/8–11 INT x 1/2–20 EXT three #5 telescoping adapters 5/8" wide one set #3 Flange Adapter 1" x 1/2" one set #3 Flange Adapter 1" x 5/8" two 2" OD x 1/2" ID Steel Washers two 2" OD x 5/8" ID Steel Washers one end cap 1" x 1/2–20 INT | 1/2–20 EXT x 5/8–11 INT | 1 |
| |  | 051144-45038-1 | 45038 | Kit contains: <ul style="list-style-type: none"> one spindle extension four 3/8" wide spacers two 3/16" wide spacers one 1" arbor hole adapter one cap nut one Allen Wrench | 5/8–11 EXT x 5/8–11 INT | 1 |
| |  | 051141-27819-5 | 28719 | <ul style="list-style-type: none"> Fits 3M™ Rubber Slotted Expander Wheel (PN28718) Kit contains: <ul style="list-style-type: none"> one adapter 1" x 5/8–11 INT one end cap 1" x 5/8–11 INT one spacer 1" dia. x 5/8" CH x 3/16" wide one 5/8–11 x 1-1/2" LG SHCS one 1/2" Allen Wrench | 5/8–11 INT | 1 |

3M™ Adapters (cont.)

Used to change the attachment style of a tool for use with common attachments used on accessories for abrasive disc products.

| Product Name | UPC | Part No. | Description | Thread Size | MOQ | |
|--------------------------|---|----------------|-------------|--|-------------------------|---|
| 3M™ Spindle Extender Kit |  | 048011-04019-6 | 300 | <ul style="list-style-type: none"> Use on flexible shafts with Scotch-Brite™ Wheels 6" or 8" diameter and up to 4" wide for better alignment and handling Spindle has 5/8–11 INT thread and 5/8–11 EXT thread Kit contains: <ul style="list-style-type: none"> two 3/8" wire spacers two 1" x 5/8" flange adapters one 2" OD x 5/8" ID washer one spanner nut one spindle extension | 5/8–11 EXT x 5/8–11 INT | 1 |
| Replacement Spacers |  | 051141-28636-5 | 28636 | 1" OD x 5/8" ID x 3/8" thick | — | 1 |
| |  | 051141-28637-2 | 28637 | 1" OD x 5/8" ID x 3/16" thick | — | 1 |

3M™ Bristle Disc Adapters

| Product Name | UPC | Part No. | Description | Size | MOQ | |
|-----------------------------------|---|----------------|-------------|--|----------------|----|
| 3M™ Flange Adapter |  | 048011-27628-1 | 27628 | <ul style="list-style-type: none"> 6" Flange Adapter Flange minimum capacity of 7 discs (1/2" wide) used with 6" Radial Bristle Discs to optimize mount on bench motors with a shaft size of 1" diameter A #5 Flange Adapter can be used on shaft sizes down to 1/2" diameter | 2" Dia x 1" ID | 25 |
| 3M™ Tapered Spindle Mount Adapter |  | 048011-30133-4 | 30133 | <ul style="list-style-type: none"> Tapered Spindle Mount Adapter Adapter configured for convenient disc mount of 2" to 3" fine bristle discs Fits on standard tapered spindle for bench motors | 3/8–24 EXT | 50 |
| 3M™ Spindle Extender Adapter |  | 048011-30134-1 | 30134 | <ul style="list-style-type: none"> 6" Spindle Extender Adapter | 2" x 1/2" x 1" | 40 |

3M™ Bristle Disc Mandrel

Used with Bristle Discs to change the center hole to fit machine shaft size.

| Product Name | UPC | Part No. | Description | Length | Shank Size | MOQ | |
|--------------------------|---|----------------|-------------|--|------------|-------|---|
| 3M™ Bristle Disc Mandrel |  | 048011-27680-9 | 27680 | <ul style="list-style-type: none"> Use with small radial bristle discs 1" diameter or smaller with 1/16" center hole Fits 3/32" drill or collet chucks Max RPM 30,000 | 1-3/4" | 3/32" | 5 |

3M™ SR Rotary Cutter

Use these plastic rotary cutters on a right angle power tool with its integral metal mandrel at slow speeds to remove sealant and adhesives. Removes coatings without damaging the underlying base material like paints, primers, alodine and metal.

| Product Name | UPC | Part No. | Diameter | Length | Thread Size | Max RPM | MOQ | |
|--------------------|---|----------------|----------|--------|-------------|------------|-------|----|
| 3M™ SR Cutter No.3 |  | 048011-30096-2 | 3 | .40" | .975" | 1/4–28 EXT | 3,200 | 40 |
| 3M™ SR Cutter No.8 | | 048011-30095-5 | 8 | .83" | 1.015" | 1/4–28 EXT | 3,200 | 40 |

3M™ Disc Pad Face Plates

3M™ Disc Pad Face Plates can be easily changed without removing the hub. Allows the operator to use a single tool for multiple applications from grinding to finishing a work piece.

Available in the following densities to meet various applications:



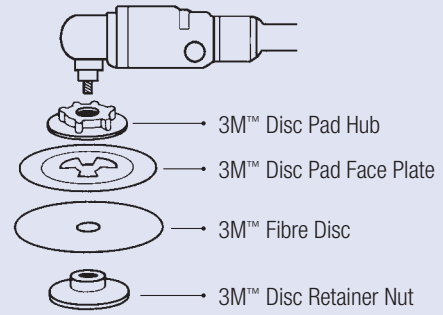

| Color | Description | Applications |
|-------|-------------|---|
| Red | Extra Hard | Heavy grinding |
| Black | Hard | Heavy metal removal, large welds, etc |
| Gray | Medium | General purpose grinding and finishing — normal flexibility |
| White | Soft | Finishing operations — flexible, follows contours |

Power Tool Assembly















3M™ Disc Pad Face Plates

For use with fibre discs. Available in various hardnesses for use with various size discs and fibre disc pad hubs.

| Product Name | UPC | Part No. | Description | Diameter | Color | Hardness | Max RPM | MOQ | |
|---------------------------------|---|----------------|-------------|----------|--------|----------|---------|--------|----|
| 3M™ Disc Pad Face Plate, Smooth |  | 051144-13325-3 | 13325 | Smooth | 4-1/2" | Gray | Medium | 13,300 | 1 |
| |  | 051144-14270-5 | 14270 | Smooth | 4-1/2" | Black | Hard | 13,300 | 1 |
| |  | 051144-45208-8 | 45208 | Smooth | 5" | White | Soft | 12,000 | 10 |
| |  | 051144-45194-4 | 45194 | Smooth | 7" | White | Soft | 8,600 | 10 |

3M™ Disc Pad Face Plates (cont.)

For use with fibre discs. Available in various hardnesses for use with various size discs and fibre disc pad hubs.

| Product Name | UPC | Part No. | Description | Diameter | Color | Hardness | Max RPM | MOQ | |
|---------------------------------|---|----------------|-------------|----------|--------|----------|------------|--------|-----|
| 3M™ Disc Pad Face Plate, Ribbed |  | 051141-28656-3 | 28656 | Ribbed | 4" | Red | Extra Hard | 15,000 | 10 |
| |  | 051141-28657-0 | 28657 | Ribbed | 4" | Black | Hard | 15,000 | 10 |
| |  | 051141-28658-7 | 28658 | Ribbed | 4" | Gray | Medium | 15,000 | 10 |
| |  | 051141-28443-9 | 28443 | Ribbed | 4-1/2" | Red | Extra Hard | 13,300 | 1 |
| |  | 051144-81734-4 | 81734 | Ribbed | 5" | Gray | Medium | 12,000 | 1 |
| |  | 051144-81733-7 | 81733 | Ribbed | 5" | Black | Hard | 12,000 | 1 |
| |  | 051144-81732-0 | 81732 | Ribbed | 5" | Red | Extra Hard | 12,000 | 1 |
| |  | 051141-28625-9 | 28625 | Ribbed | 5" | Red | Extra Hard | 12,000 | 100 |
| |  | 051144-80516-7 | 80516 | Ribbed | 7" | Gray | Medium | 8,600 | 1 |
| |  | 051144-80515-0 | 80515 | Ribbed | 7" | Black | Hard | 8,600 | 1 |
| |  | 051144-80514-3 | 80514 | Ribbed | 7" | Red | Extra Hard | 8,600 | 1 |
| |  | 051144-81729-0 | 81729 | Ribbed | 9" | Black | Hard | 6,600 | 10 |
| |  | 051144-81728-3 | 81728 | Ribbed | 9" | Red | Extra Hard | 6,600 | 10 |

3M™ Disc Pad Hubs*

Disc pad hubs have a threaded metal insert and can be used on most face plates.

| Product Name | UPC | Part No. | Description | Diameter | Thread Size | Color | MOQ | |
|-----------------------------------|---|----------------|-------------|---|-------------|-------------------------|-------|----|
| 3M™ Disc Pad Hub |  | 051144-11824-3 | 11824 | <ul style="list-style-type: none"> • GL Quick Change • Use with 4" to 7" face plates • Adapters available for M10–1.25, M10–1.50, 3/8–24 shafts* | 2-1/2" | 5/8–11 INT | Black | 1 |
| |  | 051144-45205-7 | 45205 | <ul style="list-style-type: none"> • Can be used on all 4" to 9" face plates | 2-1/2" | 5/8–11 INT | Black | 1 |
| |  | 051141-28626-6 | 28626 | <ul style="list-style-type: none"> • Can be used on all 4" to 9" face plates | 2-1/2" | 5/8–11 INT | Black | 40 |
| |  | 051144-88743-9 | 88743 | <ul style="list-style-type: none"> • For right angle grinders with 5/8–11 EXT short shafts (3/8"–1/2" long) • Can be used on 4" to 9" face plates | 2-1/2" | 5/8–11 EXT x 5/8–11 INT | Black | 1 |
| |  | 051141-28442-2 | 28442 | <ul style="list-style-type: none"> • Low Profile design allows fibre disc to fit inside tool guards • For right angle grinders with 3/8–24 EXT shaft • Can be used on all 4" to 9" face plates • 5/8–11 EXT thread for 3M retainer nuts or TN Fibre discs | 2-1/2" | 3/8–24 INT x 5/8–11 EXT | Black | 1 |
| |  | 051141-28476-7 | 28476 | <ul style="list-style-type: none"> • Low Profile design allows fibre disc to fit inside tool guards • Can be used on 4" to 9" face plates | 2-1/2" | 5/8–11 INT | Black | 10 |
| |  | 051141-28477-4 | 28477 | <ul style="list-style-type: none"> • Low Profile design allows fibre disc to fit inside tool guards • Can be used on 4" to 9" face plates | 2-1/2" | M14–2.0 INT | Black | 10 |
| |  | 051144-11823-6 | 11823 | <ul style="list-style-type: none"> • GL Quick Change • Hub is used with color-coded extra hard, hard, medium, and soft backup plates • Use with 7" face plates • Adapters available for M10–1.25, M10–1.50, 3/8–24 shafts | 4-1/2" | 5/8–11 INT | Black | 1 |
| |  | 051144-45190-6 | 45190 | <ul style="list-style-type: none"> • Can be used on 7", 8" and 9" face plates | 4-1/2" | 5/8–11 INT | Black | 1 |
| |  | 051111-60306-2 | 86100 | <ul style="list-style-type: none"> • Can be used on 7" and larger face plates | 4-1/2" | 5/8–11 INT | Black | 10 |
| 3M™ Disc Pad Hub And Retainer Nut |  | 051141-28416-3 | 28416 | <ul style="list-style-type: none"> • Disc pad hub and retainer nut kit • For use on grinders with M14–2 threaded spindle • Can be used on 4-1/2" through 9" Fiber Discs with 7/8" (22mm) center hole | 2-1/2" | M14–2.0 INT | Black | 1 |
| |  | 051141-28417-0 | 28417 | <ul style="list-style-type: none"> • Disc pad hub and retainer nut kit • For use on grinders with M14–2 threaded spindle • Can be used on 7" through 9" Fiber Discs with 7/8" (22mm) center hole | 4-1/2" | M14–2.0 INT | Black | 1 |



*See page 14

3M™ Disc Retainer Nuts

For use with 3M™ Disc Pad Hub and Face Plates and 3M™ Fibre Disc Holders. 1/4" diameter holes for use with a spanner wrench.

| Product Name | UPC | Part No. | Length | Thread Size | MOQ | |
|-----------------------|---|----------------|--------|-------------|-------------|----|
| 3M™ Disc Retainer Nut |  | 051111-51047-6 | 02618 | 5/16" | 5/8-11 INT | 10 |
| |  | 051141-28654-9 | 28654 | 5/16" | M14-2.0 INT | 10 |
| |  | 051144-05620-0 | 05620 | 5/8" | 5/8-11 INT | 1 |
| |  | 051144-05622-4 | 05622 | 3/8" | 5/8-11 INT | 1 |
| |  | 051144-05621-7 | 05621 | 1/2" | 5/8-11 INT | 1 |
| |  | 051141-28418-7 | 28418 | 1/2" | M14-2.0 INT | 10 |

3M™ Fibre Disc Backup Pads

| Product Name | UPC | Part No. | Description | Size | MOQ | |
|---|---|----------------|-------------|--|---------------------|---|
| 3M™ Fibre Disc Backup Pad  |  | 051131-05637-4 | 05637 | <ul style="list-style-type: none"> For use with Fibre Discs on pistol grip sanders Uses retainer nut supplied with sander 18,00 Max RPM | 5" x 7/8" CH | 1 |
| 3M™ TN Quick Change Fibre Disc Backup Pad |  | 051111-56573-5 | 02140 | <ul style="list-style-type: none"> TN platform allows quick change of 3M products as needed without using tools or retainer nuts Use with TN discs 13,300 Max RPM | 4-1/2" x 5/8-11 INT | 5 |

3M™ Disc Pad Hook Types

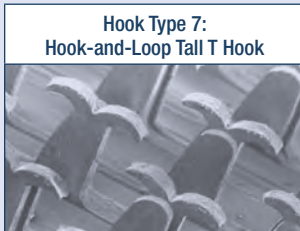
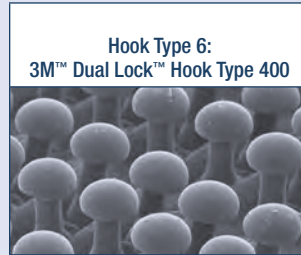
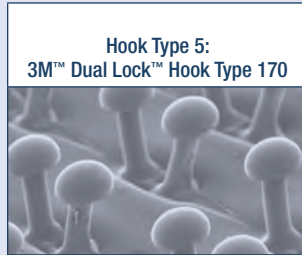
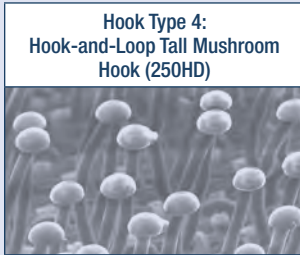
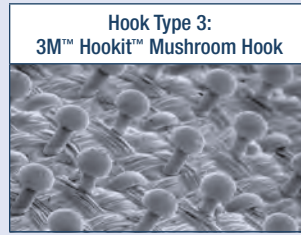
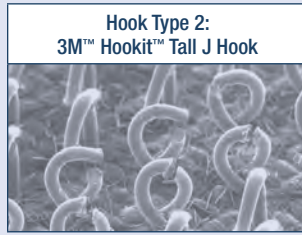
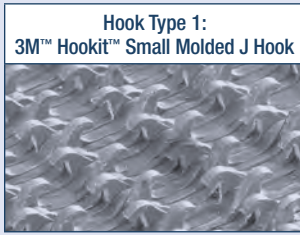

Disc Pad Holders (Hook-and-Loop)

Use with hook-and-loop discs. Allows discs to be run on right angle grinders or random orbital sanders.

| Product Name | UPC | Part No. | Size | Thick-ness | Ctr. Hole | Thread/Shank Size | Density Rating | Hook Type | Max RPM (OPM) | MOQ | |
|---|-----|----------------|------|------------|-----------|-------------------|----------------|-----------|---------------|--------|----|
| 3M™ Disc Pad Holder | | 048011-04130-8 | 9215 | 1-1/2" | 1/8" | — | 1/4" | Firm | 5 | 25,000 | 10 |
| | | 048011-07494-8 | 922 | 2" | 1/8" | — | 1/4" | Firm | 5 | 23,000 | 1 |
| | | 048011-04132-2 | 923 | 3" | 1/8" | — | 1/4" | Firm | 5 | 20,000 | 1 |
| Scotch-Brite™ Surface Conditioning Disc Pad Holder 7493 | | 051131-07493-4 | 7493 | 3" | 1/8" | — | 1/4" | Firm | 5 | 20,000 | 10 |
| Scotch-Brite™ Surface Conditioning Disc Pad 924 | | 048011-07492-4 | 924 | 4" | 1/16" | — | 1/4" | Firm | 5 | 13,000 | 5 |
| 3M™ Disc Pad Holder | | 048011-05673-9 | 914 | 4" | 1/8" | 3/8" | 1/2–13 INT | Firm | 7 | 13,000 | 1 |

Disc Pad Holders (Hook-and-Loop) (cont.)

Use with hook-and-loop discs. Allows discs to be run on right angle grinders or random orbital sanders.

| Product Name | Image | UPC | Part No. | Size | Thick-ness | Ctr. Hole | Thread/Shank Size | Density Rating | Hook Type | Max RPM (OPM) | MOQ |
|-----------------------------------|-------|----------------|----------|--------------|------------|-----------|-------------------|----------------|-----------|-----------------|-----|
| 3M™ Disc Pad Holder | | 048011-05674-6 | 914 | 4" | 1/8" | 3/8" | 5/8-11 INT | Firm | 7 | 13,000 | 1 |
| | | 048011-05677-7 | 914 | 4" | 1/8" | 3/8" | M14-2.0 INT | Firm | 7 | 13,000 | 1 |
| | | 048011-14111-4 | 9145 | 4-1/2" | 1/8" | 3/8" | 5/8-11 INT | Firm | 7 | 13,000 | 1 |
| | | 048011-14114-5 | 9145 | 4-1/2" | 1/8" | 3/8" | M14-2.0 INT | Firm | 7 | 13,000 | 1 |
| | | 048011-09448-9 | 905 | 5" | 1/4" | — | 5/16-24 EXT | Medium | 7 | 10,000 (12,000) | 1 |
| | | 048011-05680-7 | 915 | 5" | 1/8" | 3/8" | 5/8-11 INT | Firm | 7 | 10,000 | 1 |
| | | 048011-05681-4 | 915 | 5" | 1/8" | 3/8" | M14-2.0 INT | Firm | 7 | 10,000 | 1 |
| | | 048011-09449-6 | 906 | 6" | 1/4" | — | 5/16-24 EXT | Medium | 7 | 8,500 (10,000) | 1 |
| | | 048011-05682-1 | 916 | 6" | 1/8" | 3/8" | 5/8-11 INT | Firm | 7 | 10,000 | 1 |
| | | 048011-09450-2 | 917 | 7" | 5/16" | 3/8" | 5/8-11 INT | Medium | 7 | 6,000 | 1 |
| | | 051141-28409-5 | 917M | 7" | 5/16" | 3/8" | M14-2.0 INT | Medium | 7 | 6,000 | 96 |
| 3M™ Hook-and-Loop Disc Pad Holder | | 051141-20245-7 | 20245 | 7" x 7/8" ID | — | — | 5/8-11 INT | Extra Hard | 7 | 8,500 | 1 |
| 3M™ Disc Pad Holder | | 051141-20279-2 | 947TH | 7" | 1" | — | 5/8-11 INT | Medium | 7 | 6,000 | 1 |
| 3M™ Hook-and-Loop Disc Face Plate | | 051141-20439-0 | 20439 | 7" | — | — | — | Extra Hard | 7 | 8,600 | 10 |
| 3M™ Disc Pad Holder | | 048011-09451-9 | 918 | 8" | 5/16" | 3/8" | 5/8-11 INT | Medium | 7 | 6,000 | 1 |

3M™ Disc Pads Shape Profile

- 1 One piece stud design for improved balance and reduced vibration
- 2 Color-coded pads with customized features make it simpler to achieve the exact finish desired
- 3 Upgraded hole placement for clean sanding pads for the ultimate in dust extraction

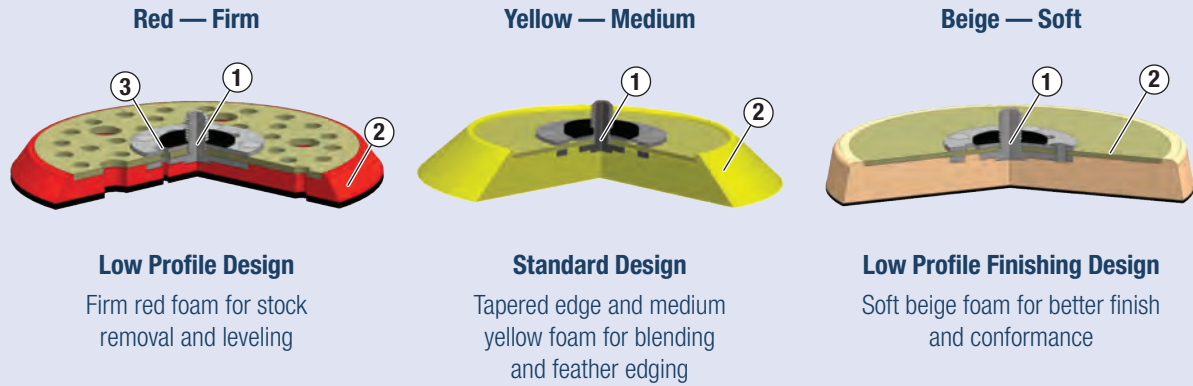

3M™ Hookit™ Disc Pads













These disc pads have a hook attachment which drives 3M™ Hookit™ Discs with brushed Nylon loop backings.

| Product Name | UPC | Part No. | Diameter | Thickness | Thread Size | Density Rating | Hook Type | Max RPM (OPM) | MOQ | |
|----------------------|-----|----------------|----------|-----------|-------------|----------------|-----------|---------------|-----------------|-----|
| 3M™ Hookit™ Disc Pad | | 051111-55764-8 | 02700 | 3" | 1/2" | 5/16-24 EXT | Firm | 2 | 15,000 (15,000) | 5 |
| | | 051141-28472-9 | 28472 | 3" | 1/2" | 1/4-20 EXT | Firm | 2 | 15,000 (15,000) | 5 |
| | | 051144-88739-2 | 88739 | 3" | 11/16" | 5/8-11 INT | Medium | 1 | 6,000 | 5 |
| | | 051144-82880-7 | 82880* | 3-1/2" | 1/2" | 5/16-24 EXT | Medium | 1 | 12,000 (12,000) | 240 |
| | | 051131-05775-3 | 05775 | 5" | 3/4" | 5/16-24 EXT | Medium | 1 | 12,000 (12,000) | 1 |
| | | 051144-85105-8 | 85105 | 5" | 3/4" | 5/8-11 INT | Medium | 1 | 12,000 | 1 |
| | | 051144-85096-9 | 85096 | 5" | 5/8" | 5/8-11 INT | Medium | 1 | 12,000 | 1 |
| | | 051141-28662-4 | 28662 | 5" | 1/2" | 5/8-11 INT | Firm | 1 | 12,000 | 1 |

*Not Available in U.S.























3M™ Hookit™ Disc Pads (cont.)

These disc pads have a hook attachment which drives 3M™ Hookit™ Discs with brushed Nylon loop backings.

| Product Name | | UPC | Part No. | Diameter | Thickness | Thread Size | Density Rating | Hook Type | Max RPM (OPM) | MOQ |
|---|--|----------------|----------|---------------|--------------|-------------|----------------|-----------|-----------------|-----|
| 3M™ Hookit™ Disc Pad |  | 048011-18444-9 | 18444 | 5" | 3/4" | M8-1.25 INT | Medium | 1 | 10,000 (12,000) | 5 |
| | LB  | 051141-28709-6 | 70138 | 6" | 3/4" | 5/16-24 EXT | Medium | 2 | 12,000 (12,000) | 1 |
| |  | 051144-13627-8 | 947 | 7" | 1" | 5/8-11 INT | Medium | 1 | 6,000 | 1 |
| |  | 051131-07394-4 | 07394 | 7" (178mm) | 1" (25mm) | M14-2.0 INT | Medium | 1 | 6,000 | 1 |
| |  | 051144-77751-8 | 77751 | 8" | 5/16" | 5/8-11 INT | Firm | 1 | 6,000 | 1 |
| |  | 051141-28548-1 | 77751B | 8" | 5/16" | 5/8-11 INT | Medium | 1 | 6,000 | 50 |
| |  Photo Not Available | 051141-20248-8 | 20248 | 8" | — | 5/8-11 INT | Firm | 1 | 6,000 | 24 |
| | CFM  | 051131-05779-1 | 05779 | 8" | 1" | 5/8-11 INT | Medium | 1 | 3,000 | 1 |
| | CFM  | 051131-05768-5 | 05768 | 8" | 1" | 5/8-11 INT | Soft | 1 | 3,000 | 1 |
|  | 051141-27884-1 | 27884 | 8" | 1/2" | 5/8-11 INT | Medium | 1 | 6,000 | 150 | |
| 3M™ Hookit™ Low Profile Disc Pad | LB  | 051141-20352-2 | 20352 | 5" | 3/8" | 5/16-24 EXT | Firm | 2 | 12,000 (12,000) | 1 |
| | LB  | 051141-20355-3 | 20355 | 6" | 3/8" | 5/16-24 EXT | Firm | 2 | 12,000 (12,000) | 1 |
| 3M™ Hookit™ Low Profile Finishing Disc Pad | LB  | 051144-77855-3 | 77855 | 5" | 11/16" | 5/16-24 EXT | Soft | 1 | 12,000 (12,000) | 1 |

3M™ Hookit™ D/F Disc Pads

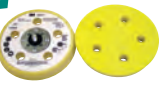
For use with 3M™ Hookit™ D/F Discs. Available in various densities and thicknesses for your vacuum sanding needs.

| Product Name | UPC | Part No. | Size | Thick-ness | Thread Size | # of Dust Holes | Density Rating | Hook Type | Max RPM (OPM) | MOQ | |
|--|--|----------------|-------|-----------------|-------------|-----------------|----------------|-----------|---------------|-----------------|---|
| 3M™ Hookit™ D/F Disc Pad |   | 051144-82659-9 | 82659 | 5" | 3/4" | 5/16-24 EXT | 5 | Medium | 1 | 12,000 (12,000) | 1 |
| |  | 051141-28411-8 | 28411 | 5" (for 6" ROS) | 3/4" | 5/16-24 EXT | 5 | Medium | 1 | 12,000 (12,000) | 1 |
| |   | 051131-05876-7 | 05876 | 6" x 3/4" CH | 3/4" | 5/16-24 EXT | 7 | Medium | 1 | 12,000 (12,000) | 1 |
| |   | 051131-07390-6 | 07390 | 6" x 3/4" CH | 3/4" | M8-1.25 EXT | 6 | Medium | 1 | 12,000 (12,000) | 1 |
| |   | 051131-05781-4 | 05781 | 8" | 3/8" | 5 Bolt Holes | 8 | Medium | 1 | 1,500 (10,000) | 1 |
| |   | 051131-05782-1 | 05782 | 8" | 3/8" | 6 Bolt Holes | 8 | Medium | 1 | 1,500 (10,000) | 1 |
| |   | 051131-05780-7 | 05780 | 8" | — | 5/8-11 INT | 12 | Firm | 3 | 1,500 | 1 |
| |   Photo Not Available | 051131-05783-8 | 05783 | 8" | 3/8" | 5 Bolt Holes | 8 | Firm | 1 | 1,500 | 1 |
| 3M™ Hookit™ D/F Low Profile Backup Pad |   | 051131-05855-2 | 05855 | 5" | 3/8" | 5/16-24 EXT | 5 | Firm | 1 | 12,000 (12,000) | 1 |
| 3M™ Hookit™ D/F Low Profile Disc Pad |   | 051141-25122-6 | 25122 | 6" | 3/8" | 5/16-24 EXT | 6 | Firm | 2 | 12,000 (12,000) | 1 |
| 3M™ Hookit™ D/F Low Profile Finishing Disc Pad |   | 051144-77856-0 | 77856 | 5" | 11/16" | 5/16-24 EXT | 5 | Soft | 1 | 12,000 (12,000) | 1 |
| |   | 051111-51042-1 | 84226 | 5" | 11/16" | 5/16-24 EXT | 5 | Soft | 1 | 12,000 (12,000) | 1 |

3M™ Hookit™ Pad

Pad provides excellent adhesion with the brushed Nylon loop backing. Hook attachment firmly secures the 3M™ Hookit™ Sheet and allows easy sheet removal. Use with 3M™ Hookit™ Abrasive Sheets.







| Product Name | UPC | Part No. | Size | Thickness | Color | Face Color | Density Rating | Hook Type | Max OPM | MOQ | |
|-----------------|---|----------------|-------|-----------|-------|------------|----------------|-----------|---------|--------|----|
| 3M™ Hookit™ Pad |  | 051141-20433-8 | 20433 | 3" x 4" | 1/2" | Red | Black | Medium | 1 | 10,000 | 10 |

3M™ Hookit™ D/F Pad

| Product Name | UPC | Part No. | Size | Thickness | # of Dust Holes | Density Rating | Hook Type | Max OPM | MOQ | |
|---------------------|---|----------------|-------|-----------|-----------------|----------------|-----------|---------|--------|-----|
| 3M™ Hookit™ D/F Pad |  | 051141-20242-6 | 20242 | 3" x 4" | 1/2" | 4 | Medium | 1 | 12,000 | 200 |

3M™ Hookit™ Roloc™ Disc Pads

Hook material attached to soft neoprene foam which provides a resilient base when using QRS Flexible Diamond discs. These disc pads allows for easy micron grade change. Pad must be used with proper Roloc™ Disc Pad hardware.

| Product Name | UPC | Part No. | Attachment | Diameter | Thickness | Density Rating | Hook Type | Max RPM (OPM) | MOQ | |
|-----------------------------|---|----------------|------------|-----------|-----------|----------------|-----------|---------------|-----------------|----|
| 3M™ Hookit™ Roloc™ Disc Pad |  | 051144-82564-6 | 82564 | Roloc™ TR | 1" | 5/16" | Medium | 2 | 8,000 (10,000) | 10 |
| |  | 051111-60311-6 | 67415 | Roloc™ TR | 1-1/16" | 5/16" | Medium | 1 | 10,000 (10,000) | 20 |
| |  | 051141-28655-6 | 28655 | Roloc™ TR | 1-1/4" | 5/16" | Medium | 1 | 10,000 (10,000) | 20 |
| |  | 051144-82565-3 | 82565 | Roloc™ TR | 1-1/2" | 5/16" | Medium | 2 | 8,000 (10,000) | 5 |
| |  | 051144-82566-0 | 82566 | Roloc™ TR | 2" | 5/16" | Medium | 2 | 8,000 (10,000) | 5 |
| |  | 051144-82567-7 | 82567 | Roloc™ TR | 3" | 5/16" | Medium | 2 | 8,000 (10,000) | 1 |

3M™ Roloc™ PSA Disc Pad

Skin surface of neoprene foam provides a resilient base when using PSA Flexible Diamond discs.

| Product Name | UPC | Part No. | Diameter | Attachment | Density Rating | Max OPM | Max RPM | MOQ | |
|-------------------------|---|----------------|----------|------------|----------------|---------|---------|--------|---|
| 3M™ Roloc™ PSA Disc Pad |  | 051144-85287-1 | 85287 | 2" | Roloc™ TR | Medium | 10,000 | 10,000 | 5 |

3M™ Hookit™ Clean Sanding Disc Pads



Designed with high performance hole patterns. Pair with a 3M™ Random Orbital Sander to increase abrasive life and achieve high efficiency dust pickup.

| Product Name | UPC | Part No. | Size | Thick-ness | Thread Size | # of Holes | Density Rating | Hook Type | Max RPM (OPM) | MOQ |
|---|----------------|----------|--------------|------------|-------------|------------|----------------|-----------|-----------------|-----|
| 3M™ Clean Sanding Disc Pad Kit* | 051141-20427-7 | 20427 | 3" | 1/2" | 5/16-24 INT | 6 | Medium | 1 | 15,000 (15,000) | 5 |
| 3M™ Clean Sanding Soft Disc Pad | 051141-20428-4 | 20428 | 3" | 3/4" | 1/4-20 EXT | 6 | Soft | 1 | 12,000 (12,000) | 10 |
| 3M™ Hookit™ Clean Sanding Low Profile Disc Pad | 051141-20350-8 | 20350 | 3" | 1/2" | 1/4-20 EXT | 3 | Firm | 2 | 15,000 (15,000) | 10 |
| 3M™ Clean Sand Painter's Pad with Hookit™ | 051131-05858-3 | 05858 | 5" x 3/4" CH | 1/2" | 5/16-24 EXT | 31 | Soft | 1 | 12,000 (12,000) | 1 |
| 3M™ Clean Sanding Backup Pad | 051141-20206-8 | 20206 | 5" x 3/4" CH | 1/2" | 5/16-24 EXT | 31 | Medium | 1 | 12,000 (12,000) | 10 |
| 3M™ Clean Sanding Low Profile Finishing Disc Pad | 051141-20290-7 | 20290 | 5" | 11/16" | 5/16-24 EXT | 44 | Soft | 1 | 12,000 (12,000) | 1 |
| 3M™ Hookit™ Clean Sanding Low Profile Disc Pad | 051141-20353-9 | 20353 | 5" | 3/8" | 5/16-24 EXT | 44 | Firm | 2 | 12,000 (12,000) | 1 |
| 3M™ Clean Sanding Low Profile Disc Pad 861 Plus | 051141-20465-9 | 20465 | 6" x 5/8" CH | 3/8" | 5/16-24 EXT | 53 | Firm | 2 | 12,000 (12,000) | 1 |
| 3M™ Clean Sanding Soft Disc Pad | 051141-20425-3 | 20425 | 6" x 3/4" CH | 1/2" | 5/16-24 EXT | 53 | Soft | 1 | 10,000 (12,000) | 1 |
| 3M™ Hookit™ Clean Sand Painter's Backup Pad | 051131-05551-3 | 05551 | 6" x 3/4" CH | 1/2" | 5/16-24 EXT | 25 | Soft | 1 | 12,000 (12,000) | 1 |
| 3M™ Hookit™ Clean Sanding Low Profile Disc Pad | 051141-20356-0 | 20356 | 6" | 3/8" | 5/16-24 EXT | 52 | Firm | 2 | 12,000 (12,000) | 1 |
| 3M™ Clean Sanding Dust Free Disc Pad with Hookit™ | 051131-05865-1 | 05865 | 6" x 3/4" CH | 1/2" | 5/16-24 EXT | 25 | Medium | 1 | 10,000 (12,000) | 10 |

*Kit includes 5 adapters: 1/4-20 EXT x 5/16-24 EXT; 1/4-20 INT x 5/16-24 EXT; 1/4-28 EXT x 5/16-24 EXT; 5/16-24 EXT x 5/16-24 EXT; 5/16-24 EXT x 6mm-1.0 EXT

3M™ Hookit™ Clean Sanding Pads

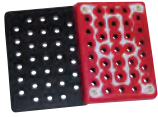
3M™ Clean Sanding Holders and Abrasives with a multi-hole design pattern to achieve high efficiency dust pickup. Use the 3M™ Vacuum Sander, Clean Sanding Holders and Clean Sanding Sheets for a total system solution.

| Product Name | UPC | Part No. | Size | Thickness | # of Holes | Color | Face Color | Density Rating | Hook Type | Max OPM | MOQ | |
|-------------------------------|---|----------------|-------|--------------|------------|-------|------------|----------------|-----------|---------|--------|----|
| 3M™ Hookit™ Clean Sanding Pad |  | 051141-20435-2 | 20435 | 3" x 4" | 1/2" | 33 | Red | Black | Medium | 1 | 10,000 | 10 |
| |  | 051141-28531-3 | 28531 | 70mm x 198mm | 12.7mm | 33 | Red | Black | Medium | 1 | 10,000 | 5 |

3M™ Hookit™ Clean Sanding Pad Hook Saver

Protects the hooks on a new 3M™ Hookit™ Clean Sanding Pad. An inexpensive attachment device to be consumed during sanding in place of a more expensive pad. Use with 3M™ Hookit™ Clean Sanding Pad (PN20435).

| Product Name | UPC | Part No. | Size | # of Holes | Face Color | Hook Type | Max OPM | MOQ | |
|----------------------------------|---|----------------|-------|------------|------------|-----------|---------|--------|----|
| 3M™ Clean Sanding Pad Hook Saver |  | 051141-28325-8 | 28325 | 3" x 4" | 33 | Black | 2 | 12,000 | 20 |

3M™ Hookit™ Soft Interface Disc Pad

Constructed of a soft durable foam to be used with standard 3M™ Hookit™ Backup Pad which increases conformability allowing the technician to get in closer to most edges.

| Product Name | UPC | Part No. | Diameter | Thickness | Density Rating | Hook Type | Max RPM (OPM) | MOQ | |
|-------------------------------------|---|----------------|----------|-----------|----------------|-----------|---------------|-----------------|----|
| 3M™ Hookit™ Soft Interface Disc Pad |  | 051111-56491-2 | 70166 | 5" | 1/2" | Soft | 1 | 12,000 (12,000) | 10 |

3M™ Hookit™ Clean Sanding Interface Pads

Use with 3M™ Clean Sanding Discs. Constructed of soft durable foam. When used with a Clean Sanding Multi-hole Hookit™ Backup Pad it increases conformability allowing you to follow contours and get closer to most edges while maximizing dust extraction.

| Product Name | UPC | Part No. | Size | Thick-ness | Ctr Hole | # of Dust Holes | Density Rating | Hook Type | Max RPM (OPM) | MOQ |
|---|----------------|----------|---------|------------|----------|-----------------|----------------|-----------|--------------------|-----|
| 3M™ Clean Sanding Interface Pad | 051141-28324-1 | 28324 | 3" x 4" | 1/2" | — | 33 | Medium | 3 | — (12,000) | 10 |
| 3M™ Clean Sanding Interface Disc Pad | 051141-28323-4 | 28323 | 5" Dia. | 1/2" | 3/4" | 31 | Medium | 3 | 12,000 (12,000) | 10 |
| 3M™ Hookit™ Soft Interface Pad CFM | 051131-05771-5 | 05771 | 3" Dia. | 1/2" | — | 6 | Soft | 3 | 15,000 (15,000) | 10 |
| 3M™ Clean Sanding Soft Interface Disc Pad | 051141-20278-5 | 20278 | 5" Dia. | 1/2" | 3/4" | 31 | Soft | 3 | 12,000 (12,000) | 10 |
| | 051141-28321-0 | 28321 | 5" Dia. | 1/2" | — | 44 | Soft | 2 | 12,000 (12,000) | 10 |
| | 051141-28322-7 | 28322 | 6" Dia. | 1/2" | — | 52 | Soft | 2 | 12,000 (12,000) | 10 |
| 3M™ Hookit™ Soft Interface Pad CFM | 051131-05777-7 | 05777 | 6" Dia. | 1/2" | 3/4" | 25 | Soft | 3 | 12,000 | 1 |

3M™ Hookit™ Clean Sanding Disc Pad Hook Savers

Protects the hooks on a new 3M™ Hookit™ Clean Sanding Disc Pad. An inexpensive attachment to be consumed during sanding in place of a more expensive disc pad.

| Product Name | UPC | Part No. | Use With | Diameter | Ctr Hole | # of Dust Holes | Hook Type | Max RPM (OPM) | MOQ |
|---------------------------------------|----------------|----------|----------|----------|----------|-----------------|-----------|--------------------|-----|
| 3M™ Clean Sanding Disc Pad Hook Saver | 051141-28326-5 | 28326 | PN20350 | 3" | — | 3 | 2 | 15,000 (15,000) | 20 |
| | 051141-20444-4 | 20444 | PN20353 | 5" | — | 44 | 2 | 12,000 (12,000) | 20 |
| | 051141-20443-7 | 20443 | PN20206 | 5" | 3/4" | 31 | 2 | 12,000 (12,000) | 20 |
| | 051141-20446-8 | 20446 | PN20356 | 6" | — | 52 | 2 | 12,000 (12,000) | 20 |
| | 051141-20445-1 | 20445 | PN05865 | 6" | 3/4" | 25 | 2 | 12,000 (12,000) | 20 |

3M™ Hook-and-Loop Conversion Face

Use to convert 3M™ Hookit™ II holders to a Hook-and-Loop holder for driving Surface Conditioning Products.

| Product Name | UPC | Part No. | Use With | Diameter | Hook Type | MOQ |
|-----------------------------------|----------------|----------|-------------------------------|----------|-----------|-----|
| 3M™ Hook-and-Loop Conversion Face | 048011-33521-6 | 33521 | Surface Conditioning Products | 11-1/4" | 4 | 5 |

3M™ Random Orbital Sander 5" & 6" Backup Pads

One Piece Stud Design, Color Coded and Simplified

Red — Firm

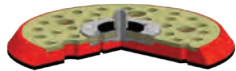

Low Profile Design

Yellow — Medium

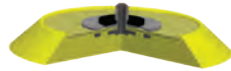

Standard Tapered Design

Beige — Soft

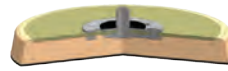





Low Profile Finishing Design

ALL PADS
AVAILABLE IN
5 & 10 CASE
LARGE BUY



| | ATTACHMENT | # HOLES | PN | UPC | DIA. | THICKNESS | THREAD | FOAM | FACE | PADS/CASE | 3M ID | |
|-----------------------|------------|--------------------|------------------|----------------|----------------|-----------|-------------|-------------|--------|-----------|----------------|----------------|
| LOW PROFILE | | 3M™ Stikit™ | — | 20351 | 051141-20351-5 | 5" | 3/8" | 5/16-24 EXT | Red | Blue | 10 | 60-4402-4106-9 |
| | | 3M™ Stikit™ | — | 20354 | 051141-20354-6 | 6" | 3/8" | 5/16-24 EXT | Red | Blue | 10 | 60-4402-4107-7 |
| | | 3M™ Stikit™ | — | 85104 | 051144-85104-1 | 5" | 3/8" | 5/16-24 EXT | Red | Silver | 10 | 60-4402-4132-5 |
| | | 3M™ Stikit™ | 5 Holes | 20442 | 051141-20442-0 | 5" | 3/8" | 5/16-24 EXT | Red | Blue | 10 | 60-4402-4109-3 |
| | | 3M™ Stikit™ | 6 Holes | 20454 | 051141-20454-3 | 6" | 3/8" | 5/16-24 EXT | Red | Blue | 10 | 60-4402-4108-5 |
| | | 3M™ Hookit™ | — | 20352 | 051141-20352-2 | 5" | 3/8" | 5/16-24 EXT | Red | Black | 10 | 604402-4110-1 |
| | | 3M™ Hookit™ | — | 20355 | 051141-20355-3 | 6" | 3/8" | 5/16-24 EXT | Red | Black | 10 | 60-4402-4111-9 |
| | | 3M™ Hookit™ | 5 Holes | 05855 | 051131-05855-2 | 5" | 3/8" | 5/16-24 EXT | Red | Yellow | 10 | 60-4402-4137-4 |
| | | 3M™ Hookit™ | 6 Holes | 25122 | 051141-25122-6 | 6" | 3/8" | 5/16-24 EXT | Red | Black | 10 | 60-4402-4112-7 |
| | | 3M™ Hookit™ | 44 Holes | 20353 | 051141-20353-9 | 5" | 3/8" | 5/16-24 EXT | Red | Black | 10 | 60-4402-4115-0 |
| 3M™ Hookit™ | | 52 Holes | 20356 | 051141-20356-0 | 6" | 3/8" | 5/16-24 EXT | Red | Black | 10 | 60-4402-4113-5 | |
| 3M™ Hookit™ | | 861 Plus, 51 Holes | 20465 | 051141-20465-9 | 6" | 3/8" | 5/16-24 EXT | Red | Black | 10 | 60-4402-4114-3 | |
| STANDARD | | 3M™ Stikit™ | — | 05575 | 051144-05575-3 | 5" | 3/4" | 5/16-24 EXT | Yellow | Blue | 10 | 60-4402-4123-4 |
| | | 3M™ Stikit™ | — | 45215 | 051144-45215-6 | 5" | 3/4" | 5/16-24 EXT | Yellow | Silver | 10 | 60-4402-4124-2 |
| | | 3M™ Stikit™ | — | 81821 | 051144-81821-1 | 5" | 3/4" | 5/16-24 EXT | Yellow | Red | 10 | 60-4402-4125-9 |
| | | 3M™ Stikit™ | — | 28772 | 051141-28772-0 | 6" | 3/4" | 5/16-24 EXT | Yellow | Blue | 10 | 60-4402-4104-4 |
| | | 3M™ Stikit™ | 5 Holes | 45217 | 051144-45217-0 | 5" | 3/4" | 5/16-24 EXT | Yellow | Blue | 10 | 60-4402-4130-9 |
| | | 3M™ Stikit™ | 6 Holes | 45218 | 051144-45218-7 | 6" | 3/4" | 5/16-24 EXT | Yellow | Blue | 10 | 60-4402-4131-7 |
| | | 3M™ Hookit™ | — | 05775 | 051131-05775-3 | 5" | 3/4" | 5/16-24 EXT | Yellow | Yellow | 10 | 60-4402-4133-3 |
| | | 3M™ Hookit™ | — | 70138 | 051141-28709-6 | 6" | 3/4" | 5/16-24 EXT | Yellow | Yellow | 10 | 60-4402-4134-1 |
| | | 3M™ Hookit™ | 5 Holes | 82659 | 051144-82659-9 | 5" | 3/4" | 5/16-24 EXT | Yellow | Yellow | 10 | 60-4402-4138-2 |
| | | 3M™ Hookit™ | 6 Holes | 05876 | 051131-05876-7 | 6" | 3/4" | 5/16-24 EXT | Yellow | Yellow | 10 | 60-4402-4139-0 |
| LOW PROFILE FINISHING | | 3M™ Stikit™ | — | 05545 | 051131-05545-2 | 5" | 11/16" | 5/16-24 EXT | Beige | Blue | 10 | 60-4402-4126-7 |
| | | 3M™ Stikit™ | — | 05546 | 051131-05546-9 | 6" | 11/16" | 5/16-24 EXT | Beige | Blue | 10 | 60-4402-4127-5 |
| | | 3M™ Stikit™ | 5 Holes | 05645 | 051131-05645-9 | 5" | 11/16" | 5/16-24 EXT | Beige | Blue | 10 | 60-4402-4129-1 |
| | | 3M™ Stikit™ | 6 Holes | 05646 | 051131-05646-6 | 6" | 11/16" | 5/16-24 EXT | Beige | Blue | 10 | 60-4402-4128-3 |
| | | 3M™ Hookit™ | — | 77855 | 051144-77855-3 | 5" | 11/16" | 5/16-24 EXT | Beige | Yellow | 10 | 60-4402-4135-8 |
| | | 3M™ Hookit™ | 5 Holes | 77856 | 051144-77856-0 | 5" | 11/16" | 5/16-24 EXT | Beige | Yellow | 10 | 60-4402-4140-8 |
| | | 3M™ Hookit™ | 5 Holes + Groove | 84226 | 051111-51042-1 | 5" | 11/16" | 5/16-24 EXT | Beige | Black | 10 | 60-4402-4136-6 |
| | | 3M™ Hookit™ | 44 Holes | 20290 | 051141-20290-7 | 5" | 11/16" | 5/16-24 EXT | Beige | Yellow | 10 | 60-4402-4144-0 |
| | | 3M™ Hookit™ | 53 Holes | 20425 | 051141-20425-3 | 6" | 11/16" | 5/16-24 EXT | Beige | Yellow | 10 | 60-4402-4141-6 |

3M™ Stikit™ Disc Pads Face Color

| Color | Description | Applications |
|---|--|-------------------------|
|  | Slightly lower than standard adhesion, easiest removal characteristics | High heat (woodworking) |
|  | Standard level of adhesion, standard removal characteristics | General purpose |
|  | Standard level of adhesion, standard removal characteristics | General purpose |
|  | Higher level of adhesion | High speed |

3M™ Stikit™ D/F Disc Pads (Vacuum)

These disc pads have a vinyl face material which drives 3M™ Stikit™ D/F Discs (Vacuum) with Pressure Sensitive adhesive backings. Dust collection holes align with hole patterns in the abrasive discs.

| Product Name | UPC | Part No. | Diameter | Thick-ness | Thread Size | # of Dust Holes | Density Rating | Max RPM (OPM) | MOQ | |
|--|---|----------------|----------|------------|-------------|-----------------|----------------|---------------|-----------------|---|
| 3M™ Stikit™ D/F Disc Pad |  LB | 051144-45217-0 | 45217 | 5" | 3/4" | 5/16-24 EXT | 5 (Die #500FH) | Medium | 10,000 (12,000) | 1 |
| |  LB | 051144-45218-7 | 45218 | 6" | 3/4" | 5/16-24 EXT | 6 (Die #600HZ) | Medium | 10,000 (12,000) | 1 |
| 3M™ Stikit™ D/F Low Profile Disc Pad |  LB | 051141-20442-0 | 20442 | 5" | 3/8" | 5/16-24 EXT | 5 | Firm | 12,000 (12,000) | 1 |
| |  LB | 051141-20454-3 | 20454 | 6" | 3/8" | 5/16-24 EXT | 6 | Firm | 12,000 (12,000) | 1 |
| 3M™ Stikit™ D/F Low Profile Finishing Disc Pad |  LB | 051131-05645-9 | 05645 | 5" | 11/16" | 5/16-24 EXT | 5 (Die #500FH) | Soft | 12,000 (12,000) | 1 |
| |  LB | 051131-05646-6 | 05646 | 6" | 11/16" | 5/16-24 EXT | 6 (Die #600HZ) | Soft | 10,000 (12,000) | 1 |
| 3M™ Stikit™ D/F Disc Pad |  CFM | 051131-05581-0 | 05581 | 8" | 3/8" | 5 Bolt Holes | 8 (Die #800JH) | Medium | 1,500 (10,000) | 1 |
| |  CFM | 051131-05582-7 | 05582 | 8" | 3/8" | 6 Bolt Holes | 8 (Die #800JH) | Medium | 1,500 (10,000) | 1 |



3M™ Stikit™ Disc Pads

These disc pads have a vinyl face material which drives 3M™ Stikit™ Discs with Pressure Sensitive Adhesive backings.

| Product Name | | UPC | Part No. | Diameter | Thickness | Thread Size | Density Rating | Max RPM (OPM) | MOQ |
|--|--|----------------|----------|----------|-----------|-------------|----------------|-----------------|-----|
| 3M™ Stikit™ Disc Pad |  | 051111-56472-1 | 70449 | 1-1/8" | 1/8" | — | Soft | 10,000 (12,000) | 5 |
| |  | 051141-28754-6 | 28754 | 3-1/2" | 1/2" | 1/4–20 EXT | Medium | 12,000 (12,000) | 5 |
| |  | 051111-55813-3 | 70234 | 5" | 1/2" | 5/8–11 INT | Medium | 12,000 | 1 |
| |  | 051141-28661-7 | 28661 | 5" | 1/2" | 5/8–11 INT | Medium | 12,000 | 1 |
| |  | 051144-82189-1 | 82189 | 5" | 3/4" | 5/8–11 INT | Medium | 12,000 | 1 |
| | LB  | 051144-05575-3 | 05575 | 5" | 3/4" | 5/16–24 EXT | Medium | 10,000 (12,000) | 1 |
| | LB  | 051144-45215-6 | 45215 | 5" | 3/4" | 5/16–24 EXT | Medium | 10,000 (12,000) | 1 |
| | LB  | 051144-81821-1 | 81821 | 5" | 3/4" | 5/16–24 EXT | Medium | 10,000 (12,000) | 1 |
| |  | 051144-82178-5 | 82178 | 5" | 1-1/4" | 5/16–24 EXT | Soft | 7,500 (12,000) | 1 |
| | LB  | 051141-28772-0 | 28772 | 6" | 3/4" | 5/16–24 EXT | Medium | 10,000 (12,000) | 1 |
| 3M™ Stikit™ Low Profile Disc Pad | CFM  | 051144-05579-1 | 05579 | 8" | 1" | 5/8–11 INT | Medium | 3,000 | 1 |
| | CFM  | 051131-05568-1 | 05568 | 8" | 1" | 5/8–11 INT | Soft | 3,000 | 1 |
| |  | 051141-20348-5 | 20348 | 3" | 1/2" | 1/4–20 EXT | Firm | 15,000 (15,000) | 10 |
| | LB  | 051144-85104-1 | 85104 | 5" | 3/8" | 5/16–24 EXT | Firm | 10,000 (12,000) | 1 |
| 3M™ Stikit™ Low Profile Finishing Disc Pad | LB  | 051141-20351-5 | 20351 | 5" | 3/8" | 5/16–24 EXT | Firm | 12,000 (12,000) | 1 |
| | LB  | 051141-20354-6 | 20354 | 6" | 3/8" | 5/16–24 EXT | Firm | 12,000 (12,000) | 1 |
| | LB  | 051131-05545-2 | 05545 | 5" | 11/16" | 5/16–24 EXT | Soft | 12,000 (12,000) | 1 |
| | LB  | 051131-05546-9 | 05546 | 6" | 11/16" | 5/16–24 EXT | Soft | 10,000 (12,000) | 1 |

3M™ Stikit™ Pad

Lightweight, shock-resistant pads have a tough vinyl face that provides excellent adhesion yet allows quick, easy sheet removal. Well-balanced pads made with a rugged, durable, plastic hub and foam body. For use with 3" x 4" 3M™ Stikit™ Sheets or 3" wide 3M™ Stikit™ Sheet Rolls with adhesive contained on the backing.

| Product Name | UPC | Part No. | Size | Thickness | Color | Face Color | Density Rating | Max OPM | MOQ | |
|-----------------|---|----------------|-------|-----------------|-------|------------|----------------|---------|--------|----|
| 3M™ Stikit™ Pad |  | 051141-20432-1 | 20432 | 3" x 4" | 1/2" | Red | Blue | Medium | 10,000 | 10 |
| |  | 051141-28660-0 | 28660 | 2-3/4" x 7-3/4" | 1/2" | Red | Blue | Medium | 10,000 | 5 |

3M™ Stikit™ D/F Pad

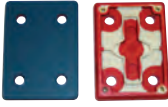
| Product Name | UPC | Part No. | Size | Thickness | Color | Face Color | Density Rating | Max OPM | MOQ | |
|---------------------|---|----------------|-------|-----------|-------|------------|----------------|---------|--------|----|
| 3M™ Stikit™ D/F Pad |  | 051141-20434-5 | 20434 | 3" x 4" | 1/2" | Red | Blue | Firm | 10,000 | 10 |



3M™ Stikit™ Soft Interface Disc Pad

Soft foam with loop material bonded on both sides. One side attaches to a 3M™ Hookit™ Backup Pad and the other side attaches to a 3M™ Stikit™ Disc.

| Product Name | UPC | Part No. | Diameter | Thickness | Foam Color | Face Color | Density Rating | Max OPM | Max RPM | MOQ | |
|-------------------------------------|---|----------------|----------|-----------|------------|------------|----------------|---------|---------|--------|----|
| 3M™ Stikit™ Soft Interface Disc Pad |  | 051111-56459-2 | 02795 | 5" | 1/2" | Black | White | Soft | 12,000 | 12,000 | 25 |

3M™ Stikit™ Dispensers

Sturdy metal dispensers for quick and easy dispensing and storage of 3M™ Stikit™ Disc and Sheet Rolls. Keeps abrasives flat while protecting the adhesive backing.

| Product Name | UPC | Part No. | Description | MOQ |
|---|----------------|----------|---|-----|
| 3M™ Stikit™ Disc Roll Dispenser  | 051144-05450-3 | 05450 | <ul style="list-style-type: none"> • For dispensing 5" or 6" 3M™ Stikit™ Disc Rolls • Portable or can be wall or bench mounted • Holds two rolls | 1 |
| 3M™ Stikit™ Double Roll Dispenser  | 051144-05452-7 | 05452 | <ul style="list-style-type: none"> • For dispensing 2-3/4" 3M™ Stikit™ Sheet Rolls • Portable • Holds two rolls | 1 |

3M™ PSA Disc Holders

PSA Disc Holders can be used with sanders that have a 1/4-inch collet chuck. Provides excellent support when grinding hard-to-reach areas. Holder face diameter is smaller than disc size to allow for easier disc centering and removal.

| Product Name | | UPC | Part No. | Diameter | Shank | Color | Face Color | Density Rating | Max RPM | MOQ |
|---------------------|---|----------------|----------|----------|-------|-------|------------|----------------|---------|-----|
| 3M™ PSA Disc Holder |  | 051144-45074-9 | 45074 | 1/2" | 1/4" | Black | Black | Medium | 20,000 | 1 |
| |  | 051144-45073-2 | 45073 | 3/4" | 1/4" | Black | Black | Medium | 20,000 | 1 |
| |  | 051144-45072-5 | 45072 | 1" | 1/4" | Black | Black | Medium | 20,000 | 1 |
| |  | 051144-45071-8 | 45071 | 1-1/2" | 1/4" | Black | Black | Medium | 20,000 | 1 |
| |  | 051144-45070-1 | 45070 | 2" | 1/4" | Black | Black | Medium | 15,000 | 1 |
| |  | 051144-05510-4 | 05510 | 3" | 1/4" | Black | Black | Medium | 20,000 | 10 |
| |  | 051144-45069-5 | 45069 | 4" | 1/4" | Black | Black | Medium | 7,500 | 1 |
| |  | 051144-45068-8 | 45068 | 5" | 1/4" | Black | Black | Medium | 6,000 | 1 |

3M™ Roloc™ Attachment Systems

Rubber disc pads are available in different diameters and types of hardness for various grinding applications.



3M™ Roloc™ TR Disc Pad

- Easily mounts directly to tools with a 1/4–20 EXT thread shaft or use with a 3M™ Roloc™ Shank to fit collet chuck tools
- Other specific thread sizes available



3M™ Roloc™ TP Disc Pad

- Disc pad for use with 3M™ Roloc™ TP Discs or with other “press on” type abrasive discs.
- Easily mounts directly to tools with a 1/4–20 EXT thread shaft or use with a 3M™ Roloc™ Shank to fit collet chuck tools



3M™ Roloc™ TS or TSM Disc Pad

- Disc pad for use with 3M™ Roloc™ TSM discs or with other “screw on” type Standard Abrasive™ abrasive discs
- Easily mounts directly to tools with a 1/4–20 EXT thread shaft or use with a 3M™ Roloc™ Shank to fit collet chuck tools

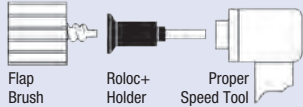

3M™ Roloc™ + Holders

- Use with 3M™ Roloc™ + products and other Scotch-Brite™ bench area Roloc™ + products or with right angle disc Sanders or straight shaft die grinders

IMPORTANT INFORMATION:

Use 3M™ Roloc™ TR Discs with 3M™ Roloc™ Disc Pads for safe, secure performance. Non-3M disc pads may have a deeper threaded cavity which causes the button to continue to tighten down during use. This can cause the button to separate from the disc resulting in the disc flying off and potential operator harm.





3M™ Roloc™ Disc Pad



Non-3M Disc Pad

3M™ Roloc™ Shanks

These shanks allow 3M™ Roloc™ TR Disc Pads to fit collet chucks or drill chucks. The 1/4–20 external thread fits 3M™ Roloc™ Disc Pads with 1/4–20 internal threads.

| Product Name | | UPC | Part No. | Shank Size | Thread Size | MOQ |
|------------------|---|----------------|----------|------------|-------------|-----|
| 3M™ Roloc™ Shank |  | 051144-82455-7 | 82455 | 6mm | 1/4–20 EXT | 5 |
| |  | 051144-45102-9 | 45102 | 1/4" | 1/4–20 EXT | 5 |

3M™ Roloc™ Disc Pad TR Assemblies

| Product Name | UPC | Part No. | Description | Diameter | Thread Size | Color | Density Rating | Max RPM | MOQ |
|--|----------------|----------|---|----------|-------------|-------|----------------|---------|-----|
|  3M™ Roloc™ Disc Pad TR Assembly | 051131-05538-4 | 05538 | • Includes a 3M™ Roloc™ shank and adapter | 1" | 1/4–20 INT | Black | Medium | 30,000 | 1 |
| | 051144-05539-5 | 05539 | • Includes a 3M™ Roloc™ shank and adapter | 2" | 1/4–20 INT | Black | Hard | 25,000 | 1 |
|  3M™ Roloc™ Gasket Removal Disc Pad Assembly | 051131-07715-7 | 07715 | • 3M™ Roloc™ gasket removal disc pad holder | 2" | 1/4–20 INT | Black | Hard | 25,000 | 1 |
|  3M™ Roloc™ Disc Pad TR Assembly | 051144-05540-1 | 05540 | • Includes a 3M™ Roloc™ shank and adapter | 3" | 1/4–20 INT | Black | Hard | 20,000 | 1 |
| | 051131-05541-4 | 05541 | • Includes a 3M™ Roloc™ shank and adapter | 4" | 1/4–20 INT | Black | Medium | 12,000 | 1 |

3M™ Roloc™ Disc Pads TR

Rubber backup pad supports 3M™ Roloc™ Discs in different degrees of hardness for varying grinding applications. Conveniently mounts directly to tools with threaded shafts or used with 3M™ Roloc™ Shank to fit collet chuck tools.

| Product Name | UPC | Part No. | Diameter | Thread Size | Color | Density Rating | Max RPM | MOQ |
|---|----------------|----------|----------|-------------|-------|----------------|---------|-----|
|  3M™ Roloc™ Disc Pad TR | 051144-45101-2 | 45101 | 1" | 1/4–20 INT | Black | Medium | 30,000 | 5 |
| | 051144-45100-5 | 45100 | 1-1/2" | 1/4–20 INT | Black | Hard | 30,000 | 5 |
| | 051144-45099-2 | 45099 | 1-1/2" | 1/4–20 INT | Black | Medium | 30,000 | 5 |
| | 051144-45098-5 | 45098 | 1-1/2" | 1/4–20 INT | Black | Soft | 30,000 | 5 |
| | 051144-45097-8 | 45097 | 2" | 1/4–20 INT | Black | Extra Hard | 25,000 | 5 |
| | 051144-45096-1 | 45096 | 2" | 1/4–20 INT | Black | Hard | 25,000 | 5 |
| | 051111-51155-8 | 51155 | 2" | 1/4–20 INT | Black | Hard | 25,000 | 50 |
| | 051144-45095-4 | 45095 | 2" | 1/4–20 INT | Black | Medium | 25,000 | 5 |







3M™ Roloc™ Disc Pads TR (cont.)

Rubber backup pad supports 3M™ Roloc™ Discs in different degrees of hardness for varying grinding applications. Conveniently mounts directly to tools with threaded shafts or used with 3M™ Roloc™ Shank to fit collet chuck tools.

| Product Name | | UPC | Part No. | Diameter | Thread Size | Color | Density Rating | Max RPM | MOQ |
|---------------------------|---|----------------|----------|----------|-------------|-------|----------------|---------|-----|
| 3M™ Roloc™ Disc Pad TR |  | 051144-45094-7 | 45094 | 2" | 1/4-20 INT | Black | Soft | 20,000 | 5 |
| |  | 051144-45093-0 | 45093 | 3" | 1/4-20 INT | Black | Extra Hard | 20,000 | 5 |
| |  | 051144-45091-6 | 45091 | 3" | 1/4-20 INT | Black | Hard | 20,000 | 5 |
| |  | 051144-88748-4 | 88748 | 3" | 3/8-24 INT | Black | Hard | 20,000 | 5 |
| |  | 051144-45092-3 | 45092 | 3" | 1/4-20 INT | Black | Medium | 18,000 | 5 |
| |  | 051144-45090-9 | 45090 | 3" | 1/4-20 INT | Black | Soft | 15,000 | 5 |
| |  | 051111-55765-5 | 82879 | 3" | 5/8-11 INT | Black | Soft | 15,000 | 5 |
| |  | 051144-84993-2 | 84993 | 75mm | M14-2.0 INT | Black | Extra Hard | 20,000 | 5 |
| |  | 051144-84998-7 | 84998 | 75mm | M14-2.0 INT | Black | Hard | 20,000 | 240 |
| |  | 051144-85000-6 | 85000 | 75mm | M10-1.5 INT | Black | Hard | 20,000 | 5 |
| |  | 051144-84999-4 | 84999 | 75mm | M14-2.0 INT | Black | Medium | 18,000 | 240 |
| |  | 051144-85001-3 | 85001 | 75mm | M10-1.5 INT | Black | Medium | 18,000 | 5 |
| |  | 051144-84994-9 | 84994 | 75mm | M14-2.0 INT | Black | Soft | 15,000 | 250 |
| |  | 051144-45179-1 | 45179 | 4" | 1/4-20 INT | Black | Medium | 12,000 | 5 |
| |  | 051144-83980-3 | 83980 | 4" | 5/8-11 INT | Black | Extra Hard | 12,000 | 5 |
| |  | 051144-83242-2 | 83242 | 4" | 5/8-11 INT | Black | Medium | 12,000 | 5 |

3M™ Roloc™ Disc Pads TR (cont.)

Rubber backup pad supports 3M™ Roloc™ Discs in different degrees of hardness for varying grinding applications. Conveniently mounts directly to tools with threaded shafts or used with 3M™ Roloc™ Shank to fit collet chuck tools.

| Product Name | | UPC | Part No. | Diameter | Thread Size | Color | Density Rating | Max RPM | MOQ |
|---------------------------|---|----------------|----------|----------|-------------|-------|----------------|---------|-----|
| 3M™ Roloc™ Disc Pad TR |  | 051144-83489-1 | 83489 | 4" | 5/8-11 INT | Black | Hard | 12,000 | 5 |
| |  | 051141-28714-0 | 28714 | 4" | 5/8-11 INT | Black | Extra Hard | 12,000 | 5 |
| |  | 051141-28713-3 | 28713 | 4" | 5/8-11 INT | Black | Hard | 12,000 | 5 |
| |  | 051141-28712-6 | 28712 | 4" | 5/8-11 INT | Black | Medium | 12,000 | 5 |
| |  | 051141-28474-3 | 28474 | 4" | 3/8-24 INT | Black | Hard | 12,000 | 5 |
| |  | 051141-28475-0 | 28475 | 4" | 3/8-24 INT | Black | Extra Hard | 12,000 | 5 |

3M™ Roloc™ Disc Pads TP

Backup pad designed to support 3M™ Roloc™ Discs. Pads have a 1/4-20 INT thread which allows it to be mounted directly to tools with 1/4-20 EXT threaded shafts or use with 3M™ Roloc™ Shank to fit collet chuck tools.

| Product Name | | UPC | Part No. | Diameter | Thread Size | Color | Density Rating | Max RPM | MOQ |
|---------------------------|---|----------------|----------|----------|-------------|-------|----------------|---------|-----|
| 3M™ Roloc™ Disc Pad TP |  | 051144-77723-5 | 77723 | 1" | 1/4-20 INT | Black | Medium | 30,000 | 5 |
| |  | 051144-77726-6 | 77726 | 1-1/2" | 1/4-20 INT | Black | Medium | 30,000 | 5 |
| |  | 051144-14197-5 | 14197 | 2" | 1/4-20 INT | Black | Medium | 25,000 | 5 |
| |  | 051144-14198-2 | 14198 | 2" | 1/4-20 INT | Black | Hard | 25,000 | 5 |
| |  | 051144-14202-6 | 14202 | 3" | 1/4-20 INT | Black | Hard | 20,000 | 5 |
| |  | 051144-14201-9 | 14201 | 3" | 1/4-20 INT | Black | Medium | 18,000 | 5 |





3M™ Roloc™ Disc Pads TS/TSM

Backup pad designed to support 3M™ Roloc™ Discs. Pad has a 1/4–20 INT thread which allows it to be mounted directly to tools with 1/4–20 EXT threaded shafts or use with 3M™ Roloc™ Shank to fit collet chuck tools.

| Product Name | UPC | Part No. | Diameter | Thread Size | Color | Density Rating | Max RPM | MOQ | |
|-------------------------------|---|----------------|----------|-------------|------------|----------------|------------|--------|---|
| 3M™ Roloc™ Disc Pad TS/TSM |  | 051144-77724-2 | 77724 | 1" | 1/4–20 INT | Black | Medium | 30,000 | 5 |
| |  | 051144-77728-0 | 77728 | 1-1/2" | 1/4–20 INT | Black | Hard | 30,000 | 5 |
| |  | 051144-77729-7 | 77729 | 1-1/2" | 1/4–20 INT | Black | Medium | 30,000 | 5 |
| |  | 051144-14211-8 | 14211 | 2" | 1/4–20 INT | Black | Medium | 25,000 | 5 |
| |  | 051144-14212-5 | 14212 | 2" | 1/4–20 INT | Black | Hard | 25,000 | 5 |
| |  | 051144-77733-4 | 77733 | 2" | 1/4–20 INT | Black | Extra Hard | 25,000 | 5 |
| |  | 051144-14215-6 | 14215 | 3" | 1/4–20 INT | Black | Medium | 18,000 | 5 |
| |  | 051144-14216-3 | 14216 | 3" | 1/4–20 INT | Black | Hard | 20,000 | 5 |
| |  | 051144-77737-2 | 77737 | 3" | 1/4–20 INT | Black | Extra Hard | 18,000 | 5 |
| |  | 051144-77740-2 | 77740 | 4" | 1/4–20 INT | Black | Medium | 12,000 | 5 |
| |  | 051144-28576-4 | 28576 | 4" | 3/8–24 INT | Black | Hard | 12,000 | 5 |
| |  | 051144-28577-1 | 28577 | 4" | 3/8–24 INT | Black | Extra Hard | 12,000 | 5 |
| |  | 051144-28578-8 | 28578 | 4" | 5/8–11 INT | Black | Hard | 12,000 | 5 |
| |  | 051144-28579-5 | 28579 | 4" | 5/8–11 INT | Black | Extra Hard | 12,000 | 5 |

3M™ Roloc™ Disc Pads TS/TSM (cont.)

Backup pad designed to support 3M™ Roloc™ Discs. Pad has a 1/4–20 INT thread which allows it to be mounted directly to tools with 1/4–20 EXT threaded shafts or use with 3M™ Roloc™ Shank to fit collet chuck tools.

| Product Name | UPC | Part No. | Diameter | Thread Size | Color | Density Rating | Max RPM | MOQ | |
|----------------------------|---|----------------|----------|-------------|-------------|----------------|------------|--------|-----|
| 3M™ Roloc™ Disc Pad TS/TSM |  | 051141-28753-9 | 28753 | 4" | M14–2.0 INT | Black | Medium | 12,000 | 100 |
| |  | 051141-28752-2 | 28752 | 4" | M14–2.0 INT | Black | Hard | 12,000 | 100 |
| |  | 051141-28742-3 | 28742 | 4" | M10–1.5 INT | Black | Extra Hard | 12,000 | 5 |
| |  | 051141-28751-5 | 28751 | 4" | M14–2.0 INT | Black | Extra Hard | 12,000 | 100 |

3M™ Roloc™ Cool Running Disc Pads

For use with tools with vacuum shrouds. (Dust shrouds ordered as KUT accessory item). Use with threaded shank or adapter supplied with vacuum shroud kits. Holes and channels in the pad allow air to flow through the pad which reduces the heat concentration.

| Product Name | UPC | Part No. | Diameter | Thread Size | # of Holes | Color | Face Color | Density Rating | Max RPM | MOQ | |
|---|---|----------------|----------|-------------|------------|-------|------------|----------------|---------|--------|---|
| 3M™ Roloc™ D/F Disc Pad |  | 051144-82974-3 | 82974 | 2" | 1/4–20 INT | 6 | Black | Black | Medium | 20,000 | 5 |
| |  | 051144-82975-0 | 82975 | 3" | 1/4–20 INT | 6 | Black | Black | Medium | 12,000 | 5 |
| |  | 051111-56479-0 | 02286 | 4" | 3/8–24 INT | 8 | Black | Black | Hard | 15,000 | 5 |
| 3M™ Roloc™ D/F Cool Running Disc Pad TR |  | 051141-28473-6 | 28473 | 4" | 5/8–11 INT | 8 | Black | Black | Hard | 15,000 | 5 |
| 3M™ Roloc™ Cool Running Disc Pad TS and TSM |  | 051141-28710-2 | 28710 | 3" | 1/4–20 INT | 6 | Black | Black | Hard | 12,000 | 5 |
| |  | 051141-28711-9 | 28711 | 2" | 1/4–20 INT | 6 | Black | Black | Hard | 20,000 | 5 |
| 3M™ Roloc™ D/F Cool Running Disc Pad TSM |  | 051141-28580-1 | 28580 | 4" | 3/8–24 INT | 8 | Black | Black | Hard | 15,000 | 5 |
| |  | 051141-28581-8 | 28581 | 4" | 5/8–11 INT | 8 | Black | Black | Hard | 15,000 | 5 |

3M™ Break Hub Cleaning

| Product Name | UPC | Part No. | Diameter | Shank Size | Color | Max RPM | MOQ |
|--|----------------|----------|----------|------------|--------|---------|-----|
| 3M™ Brake Hub Cleaning Disc Holder | 051131-07545-0 | 07545 | — | 1/4" | Black | 20,000 | 6 |
| Scotch-Brite™ Roloc™ Brake Hub Cleaning Disc Kit | 051131-07547-4 | 07547 | 1-1/2" | 1/4" | Purple | 20,000 | 5 |

3M™ Roloc™ + Buttons and Holders

Designed with extended shank which provides added bending strength for applications which require side loads.

| Product Name | UPC | Part No. | Diameter | Thread Size | Shank Size | Color | Max RPM | MOQ | |
|--------------------------------------|---|----------------|----------|-------------|------------|-------|-----------|--------|---|
| 3M™ Roloc™ + Button |  | 048011-15059-8 | 6 | 3/8" | Roloc™+ | — | Blue | 25,000 | 5 |
| |  | 048011-15060-4 | 7 | 3/8" | Roloc™+ | — | Red | 25,000 | 5 |
| 3M™ Roloc™ + Button Combination Pack |  | 048011-14915-8 | 1 and 7 | 1" | Roloc™+ | 1/4" | Black/Red | 25,000 | 5 |
| 3M™ Roloc™ + Holder |  | 051131-07500-9 | 07500 | 1" | Roloc™+ | 1/4" | Black | 25,000 | 1 |
| |  | 048011-15408-4 | 1 | 1" | Roloc™+ | 1/4" | Black | 25,000 | 5 |
| |  | 048011-33734-0 | 2 | 1-1/2" | Roloc™+ | 1/4" | Black | 25,000 | 5 |
| |  | 048011-33732-6 | 3 | 2" | Roloc™+ | 1/4" | Black | 25,000 | 5 |
| |  | 048011-33733-3 | 4 | 3" | Roloc™+ | 1/4" | Black | 25,000 | 5 |

Dressing and Shaping Tape

Conformable shaping tape used to final dress wheels and finely shape contours into wheels.

| Product Name | UPC | Part No. | Grade | Size | MOQ |
|-------------------------------------|----------------|----------|-------|--------------|-----|
| 3M™ Wheel Dressing and Shaping Tape | 048011-30201-0 | 30201 | 80 | 2" x 50 yds. | 1 |

3M™ Finesse-it™ System

Specially designed polishes for use on automotive OEM clear coats to remove sand scratches or to remove swirl marks from previous steps. For industrial use only.



Finish Comparison







Cut Comparison



3M™ Finesse-it™ Compounds and Polishes

Specially designed compounds and polishes to be used on OEM and baked refinish paints to remove sand scratches or to remove swirl marks from previously compounded areas.

| Product Name | UPC | Part No. | Description | Size | Color | MOQ | |
|--|---|----------------|-------------|----------------------|-----------|-------|----|
| 3M™ Finesse-it™ Compounding Material |  | 051144-77340-4 | 77340 | Compounding Material | Gallon | Ivory | 4 |
| 3M™ Finesse-it™ Final Finish |  | 051144-82877-7 | 82877 | Final Finish | Liter | Gray | 12 |
| | | 051144-82878-4 | 82878 | Final Finish | Gallon | Gray | 4 |
| 3M™ Finesse-it™ Final Finish Easy Clean Up |  | 051144-88753-8 | 88753 | Final Finish | 50 Gallon | Gray | 1 |
| 3M™ Finesse-it™ Finishing Material |  | 051144-13084-9 | 13084 | Finishing Material | Gallon | White | 4 |
| | | 051144-81235-6 | 81235 | Finishing Material | Liter | White | 12 |
| | | 051144-83058-9 | 83058 | Finishing Material | 50 Gallon | White | 1 |
| 3M™ Finesse-it™ Polish |  | 051141-28695-2 | 28695 | K211 | Gallon | White | 4 |
| | | 051131-06002-9 | 06002 | Extra Fine | Gallon | White | 4 |
| | | 051131-06075-3 | 06075 | Extra Fine | 50 Gallon | White | 1 |



3M™ Finesse-it™ Compounds and Polishes (cont.)

Specially designed compounds and polishes to be used on OEM and baked refinish paints to remove sand scratches or to remove swirl marks from previously compounded areas.

| Product Name | UPC | Part No. | Description | Size | Color | MOQ | |
|------------------------------|---|----------------|-------------|-----------------------------|-----------|--------|----|
| 3M™ Finesse-it™ Polish |  | 051111-51157-2 | 51056 | Purple | Gallon | Purple | 4 |
| |  | 051111-61104-3 | 61104 | Purple | 50 Gallon | Purple | 1 |
| |  | 051141-20272-3 | 20272 | Non-pigmented Purple Polish | 55 Gallon | White | 4 |
| |  | 051141-28696-9 | 28696 | Ultra Fine | Liter | White | 12 |
| 3M™ Glass Polishing Compound |  | 051111-61009-1 | 60150 | Glass Polishing Compound | Liter | White | 6 |









3M™ Finesse-it™ Disc Pads

Disc pads used to drive 3M™ Finesse-it™ Discs.

| Product Name | UPC | Part No. | Desc. | Diameter | Thick-ness | Color | Face Color | Density Rating | Hook Type | Max OPM | Max RPM | MOQ | |
|----------------------------------|---|----------------|-------|----------|-----------------|-------|------------|----------------|-----------|---------|---------|-------|----|
| 3M™ Finesse-it™ PSA Hard Pad |  | 051141-20207-5 | 3125H | PSA | 1-1/4" | 1/8" | Black | Blue | Hard | — | 7,500 | 7,500 | 10 |
| 3M™ Finesse-it™ PSA Soft Pad |  | 051111-60537-0 | 3125P | PSA | 1-1/4" | 1/8" | Black | Blue | Soft | — | 10,000 | 7,500 | 20 |
| 3M™ Finesse-it™ Hookit™ Disc Pad |  | 051144-14738-0 | 14738 | Hookit | 5" x 5/8-11 INT | 1" | Orange | Yellow | Soft | 1 | — | 7,000 | 1 |











3M™ Finesse-it™ Buffing Pads

3M™ Finesse-it™ Buffing Pads provide a soft, smooth surface for applying 3M™ Finesse-it™ Polishes. 3M™ Hookit™ Attachment System.

| Product Name | | UPC | Part No. | Desc. | Diameter | Color | Max OPM | Max RPM | MOQ |
|-----------------------------|---|----------------|----------|-------------------|----------|----------------------------|---------|---------|-------|
| 3M™ Finesse-it™ Buffing Pad |  | 134375-38287-8 | 09357 | Felt | 3" | Red/White | 12,000 | 12,000 | 50 |
| |  | 134375-38286-1 | 09358 | Felt | 5" | Red/White | 12,000 | 12,000 | 50 |
| |  | 051141-20274-7 | 20274 | Foam | 1-1/2" | Orange | 12,000 | 12,000 | 20 |
| |  | 051111-60799-2 | 01963 | Foam | 3" | White Foam/ Black Loop | 12,000 | 12,000 | 10 |
| |  | 051111-51151-0 | 02648 | Foam | 3-1/4" | Orange Foam/ White Loop | 12,000 | 12,000 | 10 |
| |  | 051111-60527-1 | 02648B | Foam | 3-1/4" | Orange Foam/ Black Loop | 12,000 | 12,000 | 10 |
| |  | 051141-25134-9 | 25134 | Foam | 3-1/4" | Gray Foam/ White Loop | 12,000 | 12,000 | 50 |
| |  | 051141-20271-6 | 20271 | Open Cell Foam | 3-3/4" | White Foam/ White Loop | 12,000 | 12,000 | 10 |
| |  | 051111-51158-9 | 02637 | Foam | 3-3/4" | Orange Foam/ White Loop | 12,000 | 12,000 | 50 |
| |  | 051141-25135-6 | 25135 | Foam | 3-3/4" | Gray Foam/ White Loop | 12,000 | 12,000 | 50 |
| |  | 051135-92500-3 | 01912 | Foam | 5-1/4" | White Foam/ Black Loop | 12,000 | 12,000 | 10 |
| |  | 051111-51076-6 | 02362 | Foam | 5-1/4" | Orange Foam/ White Loop | 12,000 | 12,000 | 10 |
| |  | 051111-60528-8 | 02362B | Foam | 5-1/4" | Orange Foam/ Black Loop | 12,000 | 12,000 | 10 |
| |  | 051141-28401-9 | 28401 | Open Cell Foam | 5-1/4" | White Foam | 12,000 | 12,000 | 900 |
| |  | 051141-28574-0 | 28574 | Foam | 5-1/4" | Gray Foam | 12,000 | 12,000 | 1,500 |

3M™ Finesse-it™ Buffing Pads (cont.)

3M™ Finesse-it™ Buffing Pads provide a soft, smooth surface for applying 3M™ Finesse-it™ Polishes. 3M™ Hookit™ Attachment System.



| Product Name | | UPC | Part No. | Desc. | Diameter | Pile Height | Color | MOQ |
|-------------------------------------|---|----------------|----------|---------|----------|-------------|-------|-----|
| 3M™ Finesse-it™ Knit Buffing Pad |  | 051144-85078-5 | 85078 | Knit | 3" | 15/16" | White | 10 |
| |  | 051144-85079-2 | 85079 | Knit | 5-1/4" | 15/16" | White | 10 |
| 3M™ Finesse-it™ Knit II Buffing Pad |  | 051144-85084-6 | 85084 | Knit II | 3" | 15/16" | White | 10 |
| |  | 051144-85099-0 | 85099 | Knit II | 3" | 11/16" | White | 10 |
| |  | 051144-85083-9 | 85083 | Knit II | 5-1/4" | 15/16" | White | 10 |
| 3M™ Finesse-it™ Natural Buffing Pad |  | 051111-50193-1 | 5730 | Natural | 3" | 1/4" | White | 10 |
| |  | 051144-81470-1 | 81470 | Natural | 3" | 20mm | White | 10 |
| |  | 051144-85103-4 | 85103 | Natural | 3" | 20mm | Black | 10 |
| |  | 051144-81471-8 | 81471 | Natural | 5-1/4" | 20mm | White | 10 |
| |  | 051144-85100-3 | 85100 | Natural | 5-1/4" | 20mm | Black | 10 |
| |  | 051141-28410-1 | 28410 | Knit II | 5-1/4" | 11/16" | White | 50 |
| |  | 051144-82531-8 | 82531 | Natural | 7" | 20mm | White | 10 |

3M™ Perfect-it™ II Wool Compounding Pad

Made of fine wool fibers stitched into a polyester backing with a 11/16" trim length. Pad is pre-washed to reduce lint. Designed with a 3M™ Hookit™ Attachment System for use with 3M™ Finesse-it™ Polishes.

| Product Name | | UPC | Part No. | Diameter | Color | MOQ |
|---|---|----------------|----------|----------|-------|-----|
| 3M™ Perfect-it™ II Wool Compounding Pad |  | 051111-51043-8 | 01927 | 5-1/4" | White | 2 |

3M™ Buffing and Polishing Accessories

| Product Name | UPC | Part No. | Size | Thread Size | Density Rating | Max RPM (OPM) | MOQ |
|--|----------------|----------|----------|-------------|----------------|---------------|-----|
| 3M™ Buff Pad Adaptor   | 051144-05710-8 | 05710 | 1" Hex. | 5/8-11 | — | — | 10 |
| 3M™ Hookit™ Backup Pad   | 051131-05717-3 | 05717 | 7" | 5/8-11 | Soft | 3,000 | 1 |
| 3M™ Perfect-It™ Backup Pad   | 051131-05718-0 | 05718 | 7" | 5/8-11 | Soft | 3,000 | 1 |
| 3M™ Foam Compounding Pad   | 051131-05723-4 | 05723 | 8" | — | — | 2,000 (2,000) | 1 |
| 3M™ Perfect-It™ Foam Buffing Pad   | 051131-05759-3 | 05759 | 3" | — | — | 11,000 | 6 |
| 3M™ Perfect-It™ Ultrafine Foam Polishing Pad   | 051131-05760-9 | 05760 | 3" | — | — | 11,000 | 6 |
| 3M™ Perfect-It™ DA Glazing Pad   | 051131-05729-6 | 05729 | 6-3/4" | — | — | 2,000 | 12 |
| 3M™ Foam Polishing Pad   | 051131-05725-8 | 05725 | 8" | — | — | 2,000 (2,000) | 1 |
| 3M™ Ultrafine Foam Polishing Pad   | 051131-05751-7 | 05751 | 8" | — | — | 2,000 (2,000) | 1 |
| 3M™ Detailing Squeeze Bottle   | 051131-37720-2 | 37720 | 12 fl oz | — | — | — | 24 |
| 3M™ Detailing Spray Bottle   | 051131-37716-5 | 37716 | 32 fl oz | — | — | — | 24 |



Scotch-Brite™ High Performance Cloth

Ribbon-shaped fibers lift dirt and grease instead of rolling over it. Dirt and particles are trapped within knitted tufts of the fibers. Rows and rows of tufts and valleys trap large and small particles.

| Product Name | UPC | Part No. | Size | Color | Material | MOQ |
|---|----------------|----------|---------------|-------|-----------------|--------|
| Scotch-Brite™ High Performance Cloth  | 048011-26224-1 | 02021 | 17" x 19-1/2" | White | Polyester/Nylon | 1 case |









3M™ Finesse-it™ Hand Sanding Pads

Hand pads used to support 3M™ Finesse-it™ Discs.

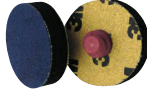
| Product Name | UPC | Part No. | Desc. | Diameter | Color | Face Color | Density Rating | MOQ | |
|----------------------------------|---|----------------|-------|-----------|--------|------------|----------------|------|----|
| 3M™ Finesse-it™ Hand Sanding Pad |  | 051144-13441-0 | 13441 | — | 1-1/4" | Red | Red | Firm | 20 |
| |  | 051111-50199-3 | 50199 | — | 1-1/4" | Red | Black | Soft | 20 |
| |  | 051135-92499-0 | 70437 | Contoured | 1-1/4" | Red | Black | Soft | 20 |



3M™ Finesse-it™ Roloc™ Backup Pads

Soft foam pads for application of polishes and glazes to remove haze and swirls. Use with 3M™ Hookit™ Discs Pads. 3M™ Hookit™ Attachment System.

| Product Name | UPC | Part No. | Diameter | Thick-ness | Thread Size | Density Rating | Hook Type/ Face | Max RPM (OPM) | MOQ | |
|---|---|----------------|----------|------------|-------------|----------------|-----------------|---------------|-----------------|-----|
| 3M™ Finesse-it™ Roloc™ Finishing Disc Pad |  | 051144-14736-6 | 14736U | 3" | 1" | Roloc™ TR | Soft | 3 | 6,000 (10,000) | 12 |
| |  | 051111-51168-8 | 14736V | 3" | 1" | Roloc™ TR | Soft | 1 | 6,000 (10,000) | 12 |
| 3M™ Finesse-it™ Roloc™ Sanding Pad |  | 051111-51150-3 | 02511 | 1-1/4" | 5/16" | Roloc™ TR | Firm | Blue Vinyl | 10,000 (12,000) | 10 |
| |  | 051144-13442-7 | 13442 | 1-1/4" | 5/16" | Roloc™ TR | Medium | Black Rubber | 6,000 (10,000) | 10 |
| |  | 051144-82271-3 | 82271 | 1-1/4" | 5/16" | Roloc™ TR | Soft | Black Rubber | 6,000 (10,000) | 10 |
| 3M™ Stikit™ Roloc™ Disc Pad |  | 051111-55833-1 | 02727 | 1-1/4" | 5/16" | Roloc™ TR | Medium | Black Vinyl | 10,000 (12,000) | 10 |
| 3M™ Finesse-it™ Roloc™ Sanding Pad |  | 051111-50198-6 | 02345 | 1-1/4" | 5/16" | Roloc™ TR | Medium | Blue Vinyl | 10,000 (12,000) | 10 |
| |  | 051141-28584-9 | 28584 | 1-1/4" | 5/16" | Roloc™ TR | Medium | Blue Vinyl | 10,000 (12,000) | 200 |
| |  | 051141-28738-6 | 28738 | 3/4" | 5/16" | Roloc™ TR | Medium | Blue Vinyl | 12,000 (12,000) | 10 |
| |  | 051141-28768-3 | 28768 | 7/8" | 5/16" | Roloc™ TR | Medium | Blue Vinyl | 12,000 (12,000) | 10 |

3M™ Hookit™ Polishing Pads

Soft foam pads for application of polishes and glazes to remove haze and swirls. Use with 3M™ Hookit™ Discs Pads. 3M™ Hookit™ Attachment System.

| Product Name | | UPC | Part No. | Desc. | Diameter | Thickness | Color | Density Rating | MOQ |
|--|---|----------------|----------|-------------|----------|-----------|-------|----------------|-----|
| 3M™ Finesse-it™ Hookit™ Type L Polishing Pad |  | 051144-76848-6 | 76848 | Flat | 5" | 1/2" | White | Soft | 100 |
| 3M™ Perfect-it™ Hookit™ Foam Polishing Pad |  | 051131-05726-5 | 05726 | Waffle Face | 3" | 1" | Black | Soft | 10 |
| |  | 051131-05727-2 | 05727 | Waffle Face | 5-1/4" | 1" | Black | Soft | 12 |

3M™ Marine Products

| Product Name | | UPC | Part No. | Description | Size | MOQ |
|---|---|----------------|----------|-------------|---------|-----|
| 3M™ Marine Aluminum Restorer and Polish |  | 051131-09020-0 | 09020 | Pink Paste | 18 oz | 6 |
| 3M™ Marine Black Streak Remover |  | 051131-09047-7 | 09047 | — | 500mL | 6 |
| 3M™ Marine Boat Soap |  | 051131-09034-7 | 09034 | Clear | 16 oz | 6 |
| 3M™ Marine Clean & Shine Wax, Clear |  | 051131-09033-0 | 09033 | — | 16.9 oz | 6 |
| 3M™ Marine Cleaner and Wax |  | 051131-09009-5 | 09009 | Beige | 16 oz | 6 |
| |  | 051131-09010-1 | 09010 | Beige | 32 oz | 6 |
| |  | 051131-09011-8 | 09011 | Beige | Gallon | 2 |
| 3M™ Marine Color/Gloss Restorer |  | 051131-09089-7 | 09089 | — | 500mL | 6 |







3M™ Marine Products (cont.)

| Product Name | UPC | Part No. | Description | Size | MOQ |
|---|----------------|----------|--------------|------------|-----|
|   3M™ Marine Finesse-it™ II Finishing Material | 051131-35929-1 | 35929 | White | Gallon | 4 |
|   3M™ Marine Finesse-it™ II Glaze | 051131-09048-4 | 09048 | White | 1 US Pint | 6 |
|   3M™ Marine Finesse-it™ II Glaze | 051131-35928-4 | 35928 | White | Quart | 6 |
|   3M™ Marine Metal Restorer and Polish | 051131-09019-4 | 09019 | Pink Paste | 18 oz | 6 |
|   3M™ Marine Mildew Block | 051131-09065-1 | 09065 | White | 16.9 fl oz | 6 |
|   3M™ Marine Mildew Stain Remover | 051131-09067-5 | 09067 | — | 16.9 fl oz | 6 |
|   3M™ Marine Non-Skid Cleaner | 051131-09063-7 | 09063 | Yellow/Brown | Liter | 6 |
|   3M™ Marine Restorer and Wax | 051131-09005-7 | 09005 | Tan | 16 fl oz | 6 |
|   3M™ Marine Restorer and Wax | 051131-09006-4 | 09006 | Tan | 32 oz | 6 |
|   3M™ Marine Restorer and Wax | 051131-09007-1 | 09007 | Tan | Gallon | 2 |
|   3M™ Marine Restorer and Wax | 051131-16896-1 | 16896 | Paste | 18 oz | 6 |

3M™ Marine Products (cont.)

| Product Name | UPC | Part No. | Description | Size | MOQ | |
|---|--|----------------|--|--|---------------|---|
|   3M™ Marine Rubbing Compound | 051131-09004-0 | 09004 | Tan | 16 oz | 6 | |
|   3M™ Marine Vinyl Cleaner and Restorer 09029 | 051131-16904-3 | 16904 | — | 15 fl oz | 6 | |
|   3M™ Marine Vinyl Cleaner, Conditioner, Protector | 051131-09023-1 | 09023 | White | 8 oz | 6 | |
|   Scotchgard™ Marine Liquid Wax | 051131-09061-3 | 09061 | — | 500mL | 6 | |
| |   | 051131-09062-0 | 09062 | — | Liter | 6 |
|   3M™ Marine Ultra Performance Paste Wax | 051131-09030-9 | 09030 | Light Yellow | 9.5 oz | 6 | |
|   3M™ Finesse-it™ Marine Paste Compound | 051131-06039-5 | 06039 | White | Gallon | 4 | |
|   3M™ Marine Compound and Finishing Material | 051131-06044-9 | 06044 | — | 32 fl oz | 12 | |
| |   | 051131-06045-6 | 06045 | — | Gallon | 4 |
| |   | 051131-06046-3 | 06046 | — | 5 Gallon Pail | 1 |
|   Photo Not Available | 051131-36044-0 | 36044 | Original Imperial Compounding and Finishing Material | 32 fl oz | 12 | |
| |   Photo Not Available | 051131-36045-7 | 36045 | Original Imperial Compounding and Finishing Material | Gallon | 4 |

3M™ Marine Products (cont.)

| Product Name | UPC | Part No. | Description | Size | MOQ | |
|--|---|----------------|-------------|-------|------------|---|
| 3M™ Marine High Gloss Gelcoat Compound |   | 051131-06025-8 | 06025 | White | Gallon | 4 |
| |   | 051131-06026-5 | 06026 | White | 50 lb Pail | 1 |
| 3M™ Premium Mold and Tooling Compound |   | 051131-06027-2 | 06027 | White | Gallon | 4 |

3M™ Flange Adapters

Flanges are metal products used to reduce an internal diameter core size to a smaller size.

| Product Name | UPC | Part No. | Description | Diameter | Inside Diameter | Width | MOQ |
|----------------------|--|----------------|--|----------|-----------------|-------|-----|
| 3M™ Flange Adapter 3 |  | 051144-45035-0 | 3 <ul style="list-style-type: none"> Reduce 1" ID core size, flange size or wheel size to fit shafts smaller than 1" diameter Stamped and formed sheet metal product Fits 5"–8" diameter flap wheels | 1" | 1/2" | — | 1 |
| |  | 051144-45033-6 | 3 <ul style="list-style-type: none"> Reduce 1" ID core size, flange size or wheel size to fit shafts smaller than 1" diameter Stamped and formed sheet metal product Fits 5"–8" diameter flap wheels | 1" | 3/4" | — | 1 |
| |  | 051144-45034-3 | 3 <ul style="list-style-type: none"> Reduce 1" ID core size, flange size or wheel size to fit shafts smaller than 1" diameter Stamped and formed sheet metal product Fits 5"–8" diameter flap wheels | 1" | 5/8" | — | 1 |
| |  | 051144-45032-9 | 3 <ul style="list-style-type: none"> Reduce 1" ID core size, flange size or wheel size to fit shafts smaller than 1" diameter Stamped and formed sheet metal product Fits 5"–8" diameter flap wheels | 1" | 7/8" | — | 1 |
| 3M™ Flange Adapter 5 |  | 048011-16860-9 | 5 <ul style="list-style-type: none"> Telescoping wheel adapter 1" wide Reduce 1" wheel to fit 1/2", 5/8", 3/4" or 7/8" shafts Use with a set of flat or cupped washers 1/3 the diameter of the wheel for side support | 1" | 1/2" | 1" | 1 |
| |  | 048011-33966-5 | 5 <ul style="list-style-type: none"> Telescoping wheel adapter 1" wide Reduce 1" wheel to fit 1/2", 5/8", 3/4" or 7/8" shafts Use with a set of flat or cupped washers 1/3 the diameter of the wheel for side support | 1" | 1/2" | 1" | 50 |
| |  | 048011-16859-3 | 5 <ul style="list-style-type: none"> Telescoping wheel adapter 1/2" wide Reduce 1" wheel to fit 1/2", 5/8", 3/4" or 7/8" shafts Use with a set of flat or cupped washers 1/3 the diameter of the wheel for side support | 1" | 1/2" | 1/2" | 1 |

3M™ RX Hub End Flange



End flanges used to securely hold RX segments in an RX hub.

| Product Name | UPC | Part No. | Diameter | Center Hole | MOQ | |
|-----------------------|---|----------------|----------|-------------|--------|---|
| 3M™ RX Hub End Flange |  | 051141-25132-5 | 25132 | 4" | 1-1/4" | 1 |

3M™ RX Hub and Heavy Duty Roto Peen Hub Assembly

Hub measures 4" diameter with a 2-1/8" ID and is furnished with flanges. The 4" Diameter Hub has 20 slots.

When ordering specify Hub Diameter x Hub Width x Flange Arbor Hole (D x W x AH).

| Product Name | UPC | Part No. | Diameter | Width | Center Hole | MOQ | |
|---|---|----------------|----------------------|-------|-------------|-----------|---|
| 3M™ Coated Abrasives, Kut Accessories, RX Hub |  | 051135-92689-5 | Determined by width* | 4" | Per order | Per order | 1 |
| 3M™ Heavy Duty Roto Peen, Hub Assembly |  | 048011-91136-6 | 91136 | 4" | Per order | Per order | 1 |

*Make-to-order

3M™ Flap Disc Adapter Nut

Adapter nut to be used with 3M™ Abrasive Flap Discs.

| Product Name | UPC | Part No. | Thread Size | MOQ | |
|---------------------------|---|----------------|-------------|------------|---|
| 3M™ Flap Disc Adapter Nut |  | 051144-88765-1 | 88765 | 5/8–11 INT | 1 |



3M™ Flap Disc Holder

Holder for 7-inch diameter 3M™ Abrasive Flap Discs and 6-inch diameter 3M™ Clean and Strip Cup Wheel.

| Product Name | UPC | Part No. | Diameter | Thread Size | MOQ | |
|--------------------------|---|----------------|----------|-------------|------------|---|
| 3M™ Flap Disc Holder T27 |  | 051144-88769-9 | 88769 | 4" | 5/8–11 INT | 1 |

3M™ Flexible Grinding Wheel Backup Pads

Clear plastic support plate used to support flexible grinding wheel.

| Product Name | UPC | Part No. | Diameter | Center Hole | Color | MOQ | |
|--|---|----------------|----------|-------------|-------|-------|---|
| 3M™ Flexible Grinding Wheel Backup Pad |  | 051111-51045-2 | 51045 | 4-5/8" | 7/8" | Clear | 5 |
| |  | 051111-51046-9 | 51046 | 3-3/8" | 7/8" | Clear | 5 |

3M™ Center Water Feed Disc Hand Pads

Pads supply water to the job and dispense the proper amount of water for wet sanding of plastics, primer surface, paint, fiberglass, etc. The water flushes the sanding residue off the sanding disc which keeps the disc from loading.



| Product Name | UPC | Part No. | Desc. | Shape | Diameter | Center Hole | Color | Face Color | Density Rating | Hook Type | MOQ | |
|--|--|----------------|--------|--------|-----------|-------------|--------|------------|----------------|-----------|-----|-----|
| 3M™ Center Water Feed Disc Hand Pad Replacement Sponge | 051144-82191-4 | 82191 | Sponge | — | 7/8" | — | Yellow | — | — | — | 10 | |
| 3M™ Hookit™ Center Water Feed Disc Hand Pad |  | 051111-56445-5 | 70147 | Hookit | Contoured | 3" | 7/8" | Yellow | Yellow | Firm | 1 | 10 |
| |  | 051144-82457-1 | 82457 | Hookit | Bullet | 3" | 7/8" | Yellow | Yellow | Firm | 1 | 10 |
| |  | 051144-88741-5 | 88741 | Hookit | Bullet | 2" | 7/8" | Yellow | Yellow | Firm | 1 | 10 |
| 3M™ Stikit™ Center Water Feed Disc Hand Pad |  | 051144-77749-5 | 77749 | Stikit | Bullet | 3" | 7/8" | Orange | Blue | Soft | — | 10 |
| |  | 051144-82705-3 | 82705 | Stikit | Bullet | 3" | 7/8" | Yellow | Blue | Firm | — | 10 |
| |  | 051111-56453-0 | 01904 | Stikit | Contoured | 3" | 7/8" | Yellow | Blue | Firm | — | 240 |

3M™ Wetordry™ Bucket

| Product Name | UPC | Part No. | Color | MOQ |
|----------------------|----------------|----------|-------|-----|
| 3M™ Wetordry™ Bucket | 051131-02513-4 | 02513 | Red | 10 |

3M™ Rubber Sanding Blocks

Rectangular sanding blocks for holding abrasive sheets.

| Product Name | UPC | Part No. | Size | Color | MOQ | |
|--------------------------|---|----------------|-------|-------------|-------|---|
| 3M™ Rubber Sanding Block |  | 051144-05519-7 | 05519 | 2-3/4" x 5" | Black | 1 |
| |  | 051131-05520-9 | 05520 | 3" x 8" | Black | 1 |







Pad Holders

Holders used to drive nonwoven surface conditioning products.

| Product Name | UPC | Part No. | Description | Size | Color | Face Color | Material | Hook Type | MOQ |
|---|--|----------|----------------------------|-------------------------------------|------------|------------------|---------------|-----------|-----|
| 3M™ Doodlebug™ Pad Holder |  048011-12929-7 | 250 | Doodlebug | 4" x 9-1/4" | Light Gray | Light Gray | Polypropylene | 7 | 5 |
| |  048011-33608-4 | 250HD | Doodlebug | 3-3/4" x 9" | Light Gray | White/Light Gray | Polypropylene | 4 | 5 |
| 3M™ Hook-and-Loop Pad Holder |  051141-28384-5 | 250BP | Doodlebug | 3-3/4" x 9" | Light Gray | White | Polypropylene | 4 | 10 |
| 3M™ Twist-Lok™ Pad Holder |  048011-09493-4 | 961 | Hand Block | 3-1/2" x 4-3/4" (Height: 2-1/2") | Light Gray | Gray | Plastic | 7 | 1 |
| Scotch-Brite™ Conformable Applicator Cleaner Head |  048011-05717-0 | 261 | Conformable | 6" x 12" | Dark Gray | Black | Nylon | 2 | 1 |
| 3M™ Insta-Lok™ Hand Block |  048011-04013-4 | 952 | Insta-Lok Hand Block, Firm | 3-3/8" x 5-3/4" | Blue | Tan | Plastic | 4 | 1 |

3M™ Hookit™ Hand Pads and Blocks

For use with 3M™ Hookit™ Sheets. Available in various densities and thicknesses for your hand sanding needs.

| Product Name | UPC | Part No. | Shape | Size | Thickness | Color | Face Color | Density Rating | Hook Type | MOQ |
|---------------------------|---|----------|------------|--------|-----------|--------|------------|----------------|-----------|-----|
| 3M™ Hookit™ Disc Hand Pad |  051111-55766-2 | 01908 | Contoured | 3" Dia | — | Yellow | Yellow | Firm | 1 | 10 |
| |  051144-77750-1 | 77750 | — | 5" Dia | 1 | Black | Black | Soft | 1 | 10 |
| |  051144-77752-5 | 77752 | — | 5" Dia | 1/4" | Black | Black | Soft | 1 | 20 |
| |  051144-85095-2 | 85095 | Contoured | 5" Dia | — | Yellow | Yellow | Firm | 1 | 10 |
| |  051111-56493-6 | 88132 | Half Round | 5" Dia | 1/4" | Black | Black | Medium | 1 | 20 |
| |  CFM 051131-05791-3 | 05791 | — | 6" Dia | 1/4" | Black | Black | Soft | 1 | 2 |
| |  051141-28777-5 | 28777 | — | 8" Dia | 1-1/8" | Black | Black | Medium | 1 | 1 |

3M™ Hookit™ Hand Pads and Blocks (cont.)

For use with 3M™ Hookit™ Sheets. Available in various densities and thicknesses for your hand sanding needs.





| Product Name | UPC | Part No. | Shape | Size | Thick-ness | Color | Face Color | Density Rating | Hook Type | MOQ | |
|--|--|----------------|------------|------------------|------------------|--------|------------|----------------|-----------|-----|----|
| 3M™ Hookit™ Half Round Pad   | 051131-05792-0 | 05792 | Half Round | 6" Dia | 1/4" | Black | Black | Medium | 1 | 1 | |
| 3M™ Hookit™ Hand Block   | 051131-05740-1 | 05740 | — | 2-3/4" x 5" | — | Yellow | Black | Firm | 1 | 1 | |
|   | 051131-05741-8 | 05741 | — | 2-3/4" x 7-3/4" | — | Yellow | Black | Firm | 1 | 1 | |
| 3M™ Hookit™ Soft Hand Block   | 051131-05742-5 | 05742 | — | 2-3/4" x 5" | — | Yellow | Yellow | Soft | 1 | 1 | |
| 3M™ Hookit™ Sanding Block   | 051131-05690-9 | 05690 | — | 2-1/2" x 5-3/8" | 5/8" | Yellow | Yellow | — | 1 | 24 | |
| |   | 051131-05685-5 | 05685 | — | 1-3/8" x 10-3/4" | 7/8" | Yellow | Yellow | — | 1 | 24 |
| |   | 051131-05686-2 | 05686 | — | 2-5/8" x 5-1/4" | 1-1/2" | Yellow | Yellow | — | 1 | 24 |
| |   | 051131-05687-9 | 05687 | — | 2-5/8" x 10-3/4" | 1-1/2" | Yellow | Yellow | — | 1 | 12 |
| |   | 051131-05688-6 | 05688 | — | 2-5/8" x 16" | 1-1/2" | Yellow | Yellow | — | 1 | 8 |
| 3M™ Hookit™ Sanding Block Round   | 051131-05689-3 | 05689 | Round | 1-1/4" x 10-3/4" | — | Yellow | Yellow | — | 1 | 24 | |
| 3M™ Hookit™ Sanding Block Teardrop   | 051131-05691-6 | 05691 | Teardrop | 2-1/8" x 10-3/4" | — | Yellow | Yellow | — | 1 | 12 | |
| 3M™ Hookit™ Sanding Stick Kit   | 051131-05670-1 | 05670 | — | — | — | Yellow | Yellow | — | 1 | 1 | |
| 3M™ Hookit™ Sanding Block Kit   | 051131-05684-8 | 05684 | — | 24" x 18" | — | Yellow | Yellow | — | 1 | 6 | |

3M™ Dust Free Hand Pads and Blocks

| Product Name | UPC | Part No. | Size | Color | Density Rating | Hook Type | MOQ | |
|---|--|----------------|-------|---------------|----------------|-----------|-----|---|
| 3M™ Hookit™ Sanding Block Dust Free |  CFM | 051131-05207-9 | 05207 | 70mm x 127mm | Purple | Firm | 1 | 5 |
| |  CFM | 051131-05208-6 | 05208 | 70mm x 198mm | Purple | Firm | 1 | 5 |
| |  CFM | 051131-05209-3 | 05209 | 70mm x 396mm | Purple | Firm | 1 | 1 |
| |  CFM | 051131-05216-1 | 05216 | 115mm x 225mm | Purple | Firm | 1 | 3 |
| 3M™ Dust Free Hose Extension Kit |  CFM | 051131-05215-4 | 05215 | — | Black | — | — | 1 |





3M™ Fairing and Hand File Boards

Designed for fairing, shaping, sanding and finishing boats, plugs and molds. Durable, lightweight construction that combines worker comfort and getting desired results quickly.

| Product Name | UPC | Part No. | Size | Color | Face Color | Hook Type | MOQ | |
|---|--|----------------|-------|--------------|------------|-----------|-----|---|
| 3M™ Hookit™ Marine Fairing Board, Flexible |  CFM | 051144-83978-0 | 83978 | 4-1/2" x 30" | Yellow | Yellow | 1 | 1 |
| 3M™ Imperial™ Hookit™ Marine Fairing Board, Rigid |  CFM | 051144-83497-6 | 83497 | 4-1/2" x 30" | Yellow | Yellow | 1 | 1 |
| 3M™ Hookit™ Marine Rigid Fairing Board II |  CFM | 051131-09082-8 | 09082 | 4-1/2" x 30" | Yellow | Black | 1 | 1 |
| 3M™ Hookit™ Hand File Board |  CFM | 051131-05744-9 | 05744 | 2-3/4" x 16" | Yellow | Black | 1 | 1 |
| 3M™ Stikit™ Hand File Board |  CFM | 051144-05444-2 | 05444 | 2-3/4" x 16" | Yellow | Blue | — | 1 |

Air File Shoes

For use on Pneumatic Orbital Air Files. Shoes feature a tuck-in clip on the leading edge for easy insertion and quick application and removal.

| Product Name | UPC | Part No. | Description | Size | MOQ |
|---|----------------|----------|---|--------------|-----|
| 3M™ Hookit™ Straightline Air File Shoe  | 051131-05748-7 | 05748 | <ul style="list-style-type: none"> For use with Hookit abrasives for multiple sanding applications Hookit pad face provides excellent adhesion and easy removal of the D/F abrasive sheets Hook Type 1 | 2-3/4" x 16" | 1 |
| 3M™ Stikit™ Air File Shoe  | 051144-05448-0 | 05448 | <ul style="list-style-type: none"> For use on all straight air files with 3M™ Stikit™ File Sheets | 2-3/4" x 16" | 1 |
| 3M™ Hookit™ Short Air File Shoe  | 051131-05750-0 | 05750 | <ul style="list-style-type: none"> Aluminum Rigid | 2-3/4" x 11" | 1 |
| 3M™ Hookit™ Orbital Air File Shoe  | 051131-05746-3 | 05746 | <ul style="list-style-type: none"> Aluminum Rigid | 2-3/4" x 16" | 1 |
| 3M™ Hookit™ Straightline File Shoe D/F  | 051131-05848-4 | 05848 | <ul style="list-style-type: none"> Aluminum Rigid | 2-3/4" x 16" | 1 |

3M™ Facing Material Rolls

Convert self-made fairing boards to the 3M™ Hookit™ Attachment System. Use 3M™ General Trim Adhesive for bonding 3M™ Hookit™ Facing Roll Material with high performance 3M™ Hookit™ Abrasive Sheets to wood surfaces.

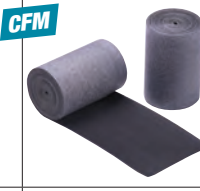
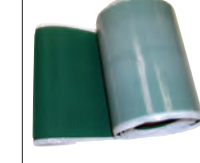
| Product Name | UPC | Part No. | Size | Color | Hook Type | MOQ |
|--|----------------|----------|-------------------------|-------|-----------|-----|
| 3M™ Hookit™ Facing Roll  | 051111-50197-9 | 88044 | 4-1/8" x 12 ft. | Black | 1 | 1 |
| 3M™ Green J Hook PSA Roll  | 051141-28441-5 | 28441 | 8" x 10 ft. (untrimmed) | Green | 2 | 1 |

3M™ Stikit™ Hand Pads and Blocks

Hand pads designed to support 3M™ Stikit™ Discs and Sheets.

| Product Name | UPC | Part No. | Size | Thickness | Foam Color | Face Color | Density Rating | MOQ | |
|-----------------------------|---|----------------|-------|---------------------|------------|------------|----------------|--------|----|
| 3M™ Stikit™ Disc Hand Pad |  | 051111-56462-2 | 06624 | 5" Dia (Half Round) | 3/8" | Black | Blue | Medium | 20 |
| |  | 051144-45188-3 | 45188 | 5" Dia | 1/8" | Black | Blue | Medium | 20 |
| |  | 051144-45189-0 | 45189 | 5" Dia | 1/4" | Black | Blue | Medium | 20 |
| |  | 051144-11063-6 | 11063 | 5" Dia | 1" | Black | Black | Soft | 10 |
| |  | 051144-84229-2 | 84229 | 5" Dia | 1" | Black | Blue | Soft | 10 |
| |  | 051144-45198-2 | 45198 | 6" Dia | 1/8" | Black | Blue | Medium | 20 |
| |  | 051131-05591-9 | 05591 | 6" Dia | 1/4" | Black | Blue | Medium | 20 |
| 3M™ Stikit™ Hand Pad |  | 051144-05585-2 | 05585 | 2-3/4" x 5" | 3/8" | Black | Black | Medium | 1 |
| |  | 051144-05586-9 | 05586 | 2-3/4" x 6" | 3/8" | Black | Black | Medium | 1 |
| 3M™ Stikit™ Hand Block |  | 051144-05440-4 | 05440 | 2-3/4" x 5" | — | Yellow | Blue | Hard | 1 |
| |  | 051144-05441-1 | 05441 | 2-3/4" x 7-3/4" | — | Yellow | Blue | Hard | 1 |
| 3M™ Stikit™ Soft Hand Block |  | 051144-05442-8 | 05442 | 2-3/4" x 5" | — | Yellow | Blue | Soft | 1 |
| 3M™ Stikit™ Soft Hand Pad |  | 051144-05530-2 | 05530 | 2-3/4" x 5-1/2" | 3/8" | Black | Black | Soft | 5 |
| 3M™ Wetordry™ Sponge Pad 20 |  | 051131-05526-1 | 05526 | 5-1/2" x 2-3/4" | 3/8" | Black | Black | Soft | 1 |
| 3M™ Stikit™ Sanding Block |  | 051144-45203-3 | 45203 | 2-1/2" | — | Red | White | Firm | 6 |
| |  | 051144-45204-0 | 45204 | 3-1/4" | — | Red | White | Firm | 6 |





3M™ Stikit™ Hand Pads and Blocks (cont.)

Hand pads designed to support 3M™ Stikit™ Discs and Sheets.

| Product Name | UPC | Part No. | Size | MOQ | |
|------------------------------------|---|----------------|-------|------------------|----|
| 3M™ Stikit™ Sanding Block |  CFM | 051131-05693-0 | 05693 | 1-3/8" x 10-3/4" | 24 |
| |  CFM | 051131-05668-8 | 05668 | 2-1/2" x 5-3/8" | 24 |
| |  CFM | 051131-05694-7 | 05694 | 2-5/8" x 5-1/4" | 24 |
| |  CFM | 051131-05695-4 | 05695 | 2-5/8" x 10-3/4" | 12 |
| |  CFM Photo Not Available | 051131-05696-1 | 05696 | 2-5/8" x 16" | 8 |
| 3M™ Stikit™ Sanding Block Round |  CFM | 051131-05672-5 | 05672 | 1-1/4" x 10-3/4" | 24 |
| 3M™ Stikit™ Sanding Block Teardrop |  CFM | 051131-05669-5 | 05669 | 2-1/8" x 10-3/4" | 12 |
| 3M™ Stikit™ Sanding Stick Kit |  CFM | 051131-05671-8 | 05671 | — | 10 |
| 3M™ Stikit™ Sanding Block Kit |  CFM | 051131-05692-3 | 05692 | — | 6 |







3M™ Screen Cloth Hand Pads

For use with screen cloth discs with two tabs (Die #500GC, 600JR and 800JM). This two-sided durable pad allows the screen cloth disc to be held onto the pad without using adhesive.

| Product Name | UPC | Part No. | Diameter | Thickness | Color | Face Color | Density Rating | MOQ | |
|--------------------------------|---|----------------|----------|-----------|-------|------------|----------------|--------|----|
| 3M™ Screen Cloth Disc Hand Pad |  | 051111-55845-4 | 02712 | 5" | 1" | Gray | Black | Medium | 10 |
| |  | 051111-60788-6 | 99736 | 6" | 1" | Black | Black | Soft | 10 |
| |  | 051111-55846-1 | 02713 | 8" | 1" | Gray | Black | Medium | 10 |
| |  | 051144-82793-0 | 82793 | 8" | 1" | Black | Black | Soft | 40 |

3M™ Cartridge Roll Mandrels

Mandrel for use with cartridge rolls to help you get to all the hard-to-get at areas on your work pieces.

| Product Name | UPC | Part No. | Pilot Diameter | Pilot Length | Shank Size | Overall Length | Max RPM | MOQ | |
|----------------------------|---|----------------|----------------|--------------|------------|----------------|---------|--------|-----|
| 3M™ Cartridge Roll Mandrel |  | 051144-45116-6 | 45116 | 1/4" | 1-1/2" | 1/4" | 3-1/2" | 24,000 | 25 |
| |  | 051144-45117-3 | 45117 | 3/16" | 1" | 1/4" | 3" | 24,000 | 1 |
| |  | 051144-45118-0 | 45118 | 3/16" | 1-1/2" | 1/4" | 3-1/2" | 24,000 | 1 |
| |  | 051144-45119-7 | 45119 | 1/8" | 1" | 1/4" | 2-3/4" | 24,000 | 1 |
| |  | 051144-88749-1 | 88749 | 1/8" | 1" | 6mm* | 3" | 24,000 | 100 |
| |  | 051144-45120-3 | 45120 | 3/32" | 3/4" | 1/4" | 2-3/4" | 24,000 | 25 |

*OUS only

3M™ Forked Spindle

Forked spindle holder for coated abrasive strips to clean and polish inner diameters and other tight areas.

| Product Name | UPC | Part No. | Slot Width | Slot Length | Shank Size | Overall Length | MOQ |
|--------------------|----------------|----------|------------|-------------|------------|----------------|-----|
| 3M™ Forked Spindle | 051144-45121-0 | 45121 | 1/16" | 3/4" | 1/4" | 3" | 1 |

3M™ Mandrels

| Product Name | UPC | Part No. | Shank Size | Overall Length | Outside Flange Diameter | Max RPM | MOQ |
|-------------------|----------------|----------|------------|----------------|-------------------------|---------|-----|
| 3M™ Mini Mandrel | 048011-04020-2 | 935 | 1/4" | 2-7/8" | — | 14,000 | 1 |
| 3M™ Wheel Mandrel | 048011-07491-7 | 938 | 1/4" | 2" | 2" | — | 1 |

3M™ Roloc™ Mandrel TS/TSM

Use with 3/4-inch 3M™ Roloc™ Discs. Designed for cleaning and finishing of airplane seat track channels.

| Product Name | UPC | Part No. | Desc. | Thread Size | Shank Size | Overall Length | MOQ |
|---------------------------|----------------|----------|----------------|------------------|------------|----------------|-----|
| 3M™ Roloc™ Mandrel TS/TSM | 051144-85097-6 | 85097 | Track Cleaning | Roloc™ TS or TSM | 1/4" | 2" | 5 |

3M™ Square/Cross Pad Mandrel

Used for tightly securing Square Pads and Cross Pads with internal threaded inserts. Mandrel has external threaded shank.

| Product Name | UPC | Part No. | Thread Size | Shank Size | Overall Length | Max RPM | MOQ |
|------------------------------|----------------|----------|-------------|------------|----------------|---------|-----|
| 3M™ Square/Cross Pad Mandrel | 051141-28385-2 | 28385 | 3-48 EXT | 1/4" | 3" | 24,100 | 1 |
| | 051144-14307-8 | 14307 | 8-32 EXT | 1/4" | 3" | 24,100 | 1 |
| | 051144-14308-5 | 14308 | 1/4-20 EXT | 1/4" | 3" | 24,100 | 1 |







3M™ Star Mandrel

Mandrel for a surface conditioning star converted into a unique shape for cleaning, polishing and light deburring of inside diameters of pipe and tubing. Dually threaded for either spin-on direction with portable hand tools.

| Product Name | UPC | Part No. | Thread Size | Shank Size | Overall Length | Max RPM | MOQ |
|------------------|----------------|----------|-------------|------------|----------------|---------|-----|
| 3M™ Star Mandrel | 048011-13928-9 | 944 | 1/4-20 EXT | 1/4" | 3" | 24,100 | 1 |

3M™ Unitized Wheel Mandrels

Recommended for use on portable tools. Excellent for edge deburring and finishing applications of small or intricate work pieces. They are available in a wide range of diameters, grades and densities and limited to a thickness no more than 1 inch.

| Product Name | UPC | Part No. | Description | Shank Size | Overall Length | Outside Flange Diameter | Max RPM | MOQ | |
|----------------------------|---|----------------|-------------|---|----------------|-------------------------|---------|--------|-----|
| 3M™ Unitized Wheel Mandrel |  | 048011-13966-1 | 931 | <ul style="list-style-type: none"> Use with wheels 1" to 1-1/2" diameter x 1/4" wide x 1/8" center hole Maximum wheel width: 1/4" Note: 5/16" center hole is recommended for wheels 6 density or harder | 1/8" | 1-1/2" | 1/2" | 13,000 | 5 |
| |  | 048011-13967-8 | 932 | <ul style="list-style-type: none"> Use with wheels 1-1/2" to 2" diameter x 1/4" to 1/2" wide x 1/4" center hole Maximum wheel width: 1/2" Note: 5/16" center hole is recommended for wheels 6 density or harder | 1/4" | 2" | 3/16" | 20,000 | 5 |
| |  | 048011-13968-5 | 933 | <ul style="list-style-type: none"> Use with wheels 2", 2-1/2" or 3" diameter x 1/4", 1/2", 3/4" wide x 1/4" center hole Maximum wheel width: 1" Note: 5/16" center hole is recommended for wheels 6 density or harder | 1/4" | 2" | 1" | 14,000 | 1 |
| |  | 051144-85004-4 | 933 | <ul style="list-style-type: none"> Use with wheels 2", 2-1/2" or 3" diameter x 1/4", 1/2", 3/4" wide x 1/4" center hole Maximum wheel width: 1" Note: 5/16" center hole is recommended for wheels 6 density or harder | 6mm* | 2" | 1" | 14,000 | 100 |
| |  | 048011-04021-9 | 934 | <ul style="list-style-type: none"> Use with wheels 3" to 6" diameter x 1/4", 1/2", 3/4" or 1" wide x 1/2" center hole | 1/4" | 3-1/6" | 2-1/2" | 12,000 | 1 |
| |  | 048011-04018-9 | 936 | <ul style="list-style-type: none"> Use with wheels 1" diameter x 1" wide x 3/16" center hole Plastic mandrel self taps into wheel | 1/4" | 2-1/16" | 3/4" | 22,200 | 1 |
| |  | 048011-15012-3 | 990 | <ul style="list-style-type: none"> Use with high speed or easy loading Unitized Wheels 2" to 3" diameter x 1/8" to 1/2" wide x 3/8" center hole Includes silver cap for 1/8" and 1/4" wide wheels Includes black cap for 3/8" and 1/2" wide wheels | 1/4" | 1-3/4" | 1" | 25,100 | 1 |



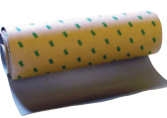

*OUS Kut item

3M™ Platen Pad Cover

Silver cloth with Pressure Sensitive Adhesive backing used to protect platen pads.

| Product Name | UPC | Part No. | Size | Face Color | MOQ | |
|----------------------|---|----------------|-------|---------------|--------|---|
| 3M™ Platen Pad Cover |  | 051111-56599-5 | 06541 | 10-1/2" x 53" | Silver | 1 |

3M™ Roto Peen Accessories

| Product Name | UPC | Part No. | Description | Length | Slot Width | Width | MOQ |
|----------------------------------|--|----------|---|--------|------------|-----------|-----|
| 3M™ Roto Peen Almen Strip Holder |  048011-03764-6 | 03764 | Use to hold Almen Strips for testing peening intensity | 7" | 1" | 2" | 1 |
| 3M™ Roto Peen Assembly Kit 09041 |  048011-17157-9 | 17157 | Convenient kit contains a 3M™ Roto Peen Almen Strip Holder, two sizes of Roto Peen Flap Assemblies TC-330, and Roto Peen Mandrels 7210 and 7211 | — | — | — | 1 |
| 3M™ Roto Peen Mandrel |  048011-03768-4 | 7210 | Use with 3M™ Roto Peen Flap Assemblies 9/16" x 1-1/4" | 3" | 1/16" | 1/4" Dia. | 1 |
| |  048011-03767-7 | 7211 | Use with 3M™ Roto Peen Flap Assemblies 1" x 2" | 8" | 1/16" | 3/8" Dia. | 1 |
| |  048011-05969-3 | 7212 | Use with 3M™ Roto Peen Flap Assemblies 9/16" x 1" | 3" | 1/16" | 1/4" Dia. | 1 |



















Molding Adhesive and Stripe Removal

Used to remove vinyl stripes, numbers, letters and graphics from gel coat and painted marine surfaces without damaging the finish.

| Product Name | UPC | Part No. | Desc. | Diameter | Thick-ness | Center Hole | Thread Size | Color | Density Rating | Max RPM | MOQ |
|--|--|----------|--------------------|----------|------------|-------------|-------------|-------|----------------|---------|-----|
| Scotch-Brite™ Molding Adhesive and Stripe Removal Disc |  051131-07501-6 | 07501 | Foam Disc | 4" | — | 3/8" | — | White | — | 4,000 | 5 |
| | 051131-07502-3 | 07502 | Foam Disc | 6" | — | 3/8" | — | White | — | 2,800 | 5 |
| Scotch-Brite™ Large Area Stripe Removal Disc |  051131-07517-7 | 07517 | Foam Disc | 8" | — | 5/8" | — | White | — | 3,000 | 1 |
| 3M™ Stripe Off Wheel |  051131-07498-9 | 07498 | Wheel With Mandrel | 4" | 5/8" | — | 3/8–16 INT | Beige | Medium | 4,000 | 5 |
| |  051131-07499-6 | 07499 | Wheel | 4" | 5/8" | — | 3/8–16 INT | Beige | Medium | 4,000 | 5 |

3M™ Rubber Cushion Polishing Wheels

A mechanically expandable rubber cushion available in a wide variety of sizes safely keeps 3M™ Bands and Belts from slipping during use with 3M™ Coated Abrasive Bands and Belts.

| Product Name | UPC | Part No. | Diameter | Width | Shank Size | Color | Max RPM | MOQ | |
|------------------------------------|---|----------------|----------|--------|------------|-------|---------|--------|---|
| 3M™ Rubber Cushion Polishing Wheel |  | 051144-45159-3 | 45159 | 1/4" | 1/2" | 1/8" | Black | 23,000 | 1 |
| |  | 051144-45153-1 | 45153 | 1/2" | 1" | 1/4" | Black | 15,000 | 1 |
| |  | 051144-45156-2 | 45156 | 1/2" | 1/2" | 1/4" | Black | 30,000 | 1 |
| |  | 051144-45152-4 | 45152 | 1/2" | 1-1/2" | 1/4" | Black | 15,000 | 1 |
| |  | 051144-45145-6 | 45145 | 3/4" | 1" | 1/4" | Black | 17,000 | 1 |
| |  | 051144-45148-7 | 45148 | 3/4" | 1/2" | 1/4" | Black | 30,000 | 1 |
| |  | 051144-45144-9 | 45144 | 3/4" | 1-1/2" | 1/4" | Black | 10,000 | 1 |
| |  | 051144-45146-3 | 45146 | 3/4" | 3/4" | 1/4" | Black | 24,000 | 1 |
| |  | 051144-45139-5 | 45139 | 1" | 1" | 1/4" | Black | 18,000 | 1 |
| |  | 051144-45138-8 | 45138 | 1" | 1-1/2" | 1/4" | Black | 10,000 | 1 |
| |  | 051144-45137-1 | 45137 | 1" | 2" | 1/4" | Black | 8,000 | 1 |
| |  | 051144-45132-6 | 45132 | 1-1/2" | 1" | 1/4" | Black | 14,000 | 1 |
| |  | 051144-45131-9 | 45131 | 1-1/2" | 1-1/2" | 1/4" | Black | 10,000 | 1 |
| |  | 051144-45130-2 | 45130 | 1-1/2" | 2" | 1/4" | Black | 8,000 | 1 |
| |  | 051144-45129-6 | 45129 | 2" | 1" | 1/4" | Black | 11,000 | 1 |
| |  | 051144-45127-2 | 45127 | 2" | 2" | 1/4" | Black | 6,000 | 1 |
| |  | 051144-45123-4 | 45123 | 3" | 3" | 1/2" | Black | 3,000 | 1 |
| |  | 051144-45124-1 | 45124 | 3" | 3" | 3/8" | Black | 3,000 | 1 |

3M™ Rubber Slotted Expander Wheels



Slotted wheels available in a wide variety of sizes for use with 3M™ Bands and Belts. Centrifugal force while tool is running holds band on expander wheel.

| Product Name | UPC | Part No. | Diameter | Width | Center Hole | Thread Size | Shank Size | Color | Density Rating | Max RPM | MOQ | |
|-----------------------------------|--|----------------|----------|--------|-------------|-------------|------------|-------|----------------|---------|--------|---|
| 3M™ Rubber Slotted Expander Wheel |  | 051144-77717-4 | 77717 | 1" | 1" | — | — | 1/4" | Black | Medium | 18,000 | 1 |
| |  | 051144-77718-1 | 77718 | 1-1/2" | 1" | — | — | 1/4" | Black | Medium | 14,000 | 1 |
| |  | 051144-77720-4 | 77720 | 2" | 1" | — | — | 1/4" | Black | Medium | 12,000 | 1 |
| |  | 051144-77721-1 | 77721 | 2" | 2" | — | — | 1/4" | Black | Medium | 6,000 | 1 |
| |  | 051144-77722-8 | 77722 | 3" | 3" | — | 5/8-11 INT | — | Black | Medium | 6,000 | 1 |
| |  | 051141-28349-4 | 28349* | 3.4" | 3" | 5/8" | — | — | Black | Soft | 3,500 | 1 |
| |  | 051141-28348-7 | 28348** | 5" | 3-1/2" | 5/8" | — | — | Black | Soft | 3,500 | 1 |
| |  | 051141-28718-8 | 28718 | 5" | 3-1/2" | 1" | — | — | Black | Soft | 3,500 | 1 |

*3" x 10-11/16" Belt **3-1/2" x 10-15-1/2" Belt

3M™ Wetordry™ Rubber Squeegees

Flexible, sturdy rubber used for removing slush created when sanding or applying glazing putty and plastic filler.

| Product Name | UPC | Part No. | Size | Thickness | Color | Density Rating | MOQ | |
|-------------------------------|---|----------------|-------|-----------------|-------|----------------|------|---|
| 3M™ Wetordry™ Rubber Squeegee |  | 051144-05518-0 | 05518 | 2" x 3" | 3/16" | Black | Firm | 1 |
| |  | 051144-05517-3 | 05517 | 2-3/4" x 4-1/4" | 3/16" | Black | Firm | 1 |

3M™ All Purpose Tack Cloth

3M™ All Purpose Tack Cloth stays soft for a comfortable cleanup just before painting and is reusable. Use to remove dirt, lint, dust and sanding particles from metal, plastic, fiberglass and wood.

| Product Name | UPC | Part No. | Size | Color | Material | MOQ |
|------------------------|----------------|----------|---------------|-------|-----------------------|-----|
| 3M™ Tack Pad | 051131-07910-6 | 07910 | 175mm x 235mm | White | Foam | 1 |
| 3M™ Tack Pad Dispenser | 051131-07909-0 | 07909 | — | — | — | 1 |
| 3M™ Tack Cloth | 051111-10132-2 | 10132NA | 17" x 36" | White | Woven Synthetic Fiber | 48 |

Power Tool Conversion Replacement Parts

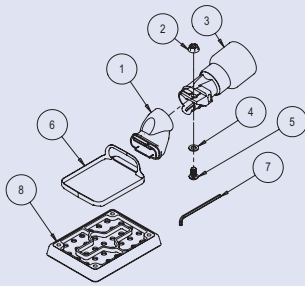

3" x 4" Non-Vacuum to Central Vacuum

| Model # | Description | Part # |
|---------|--|--------|
| ① A1350 | Snap-On Exhaust Adaptor | 28162 |
| ② A0048 | M5 Flanged Nut | 28120 |
| ③ A1360 | Orbital Sander Central Vacuum Swivel Exhaust Assembly, 1" (28mm) | 28168 |
| ④ A0047 | M5 Washer | 28119 |
| ⑤ A0769 | Screw | 28145 |
| ⑥ A1356 | Shroud Seal | 28166 |
| ⑦ A0864 | Hex Wrench, 2.5mm | 28147 |
| ⑧ 20435 | 3M™ Hookit™ Clean Sanding Pad, 3" x 4" x 1/2", Red Foam | 20435 |

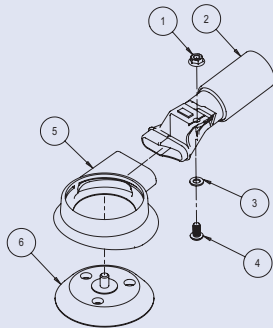

3" Non-Vacuum to Central Vacuum

| Model # | Description | Part # |
|---------|---|--------|
| ① A0048 | M5 Flanged Nut | 28120 |
| ② A1343 | Central Vacuum Random Orbital Sander Swivel Exhaust Assembly | 28157 |
| ③ A0047 | M5 Washer | 28119 |
| ④ A0769 | Screw | 28145 |
| ⑤ A1335 | Random Orbital Sander Skrit/Shroud | 28155 |
| ⑥ 20350 | 3M™ Hookit™ Clean Sanding Low Profile Disc Pad, 3" x 1/2" x 1/4-20 EXT, 3 Holes, Red Foam | 20350 |

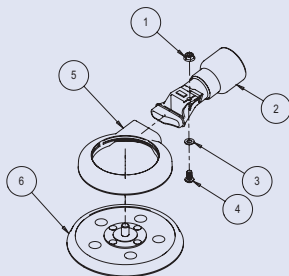

5" Non-Vacuum to Central Vacuum

| Model # | Description | Part # |
|---------|---|--------|
| ① A0048 | M5 Flanged Nut | 28120 |
| ② A1343 | Central Vacuum Random Orbital Sander Swivel Exhaust Assembly | 28157 |
| ③ A0047 | M5 Washer | 28119 |
| ④ A0769 | Screw | 28145 |
| ⑤ A1347 | Shroud | 28159 |
| ⑥ 20353 | 3M™ Hookit™ Clean Sanding Low Profile Disc Pad, 5" x 3/8" x 5/16-24 EXT, 44 Holes, Red Foam | 20353 |

Power Tool Conversion Replacement Parts

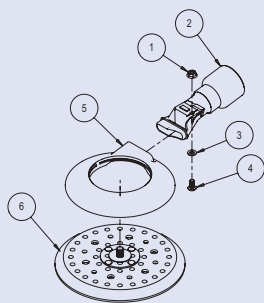

6" Non-Vacuum to Central Vacuum

| Model # | Description | Part # |
|---------|---|--------|
| ① A0048 | M5 Flanged Nut | 28120 |
| ② A1343 | Central Vacuum Random Orbital Sander Swivel Exhaust Assembly | 28157 |
| ③ A0047 | M5 Washer | 28119 |
| ④ A0769 | Screw | 28145 |
| ⑤ A1348 | Random Orbital Sander Clean Sanding Shroud | 28160 |
| ⑥ 20356 | 3M™ Hookit™ Clean Sanding Low Profile Disc Pad, 6" x 3/8" x 5/16-24 EXT, 52 Holes, Red Foam | 20356 |

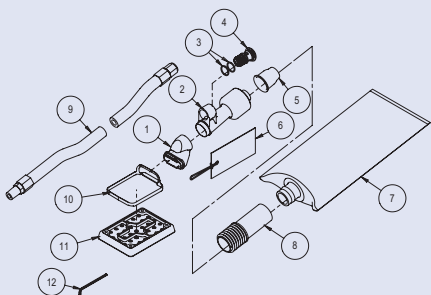

3" x 4" Non-Vacuum to Self-Generated Vacuum

| Model # | Description | Part # |
|----------|---|--------|
| ① A1350 | Snap-On Exhaust Adaptor | 28162 |
| ② A1338 | Self-Generated Vacuum Hose Swivel Exhaust Assembly, 1" (28mm) | 28156 |
| ③ A0044 | O-Ring, 14" x 1-1/2" | 28117 |
| ④ A0722 | Self-Generated Vacuum Retainer | 28141 |
| ⑤ A00778 | Hose Seal | 28146 |
| ⑥ NA | TAG | NA |
| ⑦ 20452 | Clean Sanding Filter Bag, Large | 20452 |
| ⑧ 20453 | Filter Bag Adaptor, 1" EXT Hose Thread x 1" ID | 20453 |
| ⑨ 20209 | Random Orbital Sander Air Line Extension, 3/8" x 4' | 20209 |
| ⑩ A1356 | Shroud Seal | 28166 |
| ⑪ 20435 | 3M™ Hookit™ Clean Sanding Pad, 3" x 4" x 1/2", Red Foam | 20435 |
| ⑫ A0864 | Hex Wrench, 2.5mm | 28147 |

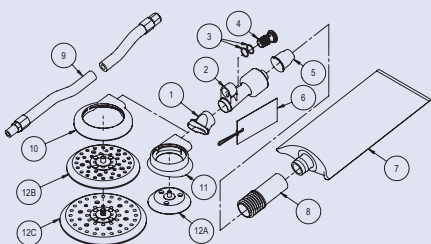

3", 5", 6" Non-Vacuum to Self-Generated Vacuum

| Model # | Description | Part # |
|----------|---|--------|
| ① A1333 | Self-Generated Vacuum Skrit/Shroud Adaptor | 28153 |
| ② A1338 | Self-Generated Vacuum Hose Swivel Exhaust Assembly, 1" (28mm) | 28156 |
| ③ A0044 | O-Ring, 14" x 1-1/2" | 28117 |
| ④ A0006 | Self-Generated Vacuum Retainer | 28095 |
| ⑤ A00778 | Hose Seal | 28146 |
| ⑥ NA | TAG | NA |
| ⑦ 20452 | Clean Sanding Filter Bag, Large | 20452 |
| ⑧ 20453 | Filter Bag Adaptor, 1" EXT Hose Thread x 1" ID | 20453 |
| ⑨ 20209 | Random Orbital Sander Air Line Extension, 3/8" x 4 ft. | 20209 |
| ⑩ A1347 | 5 5/8" Shroud | 28159 |
| ⑩ A1348 | 6" Random Orbital Sander Clean Sanding Shroud | 28160 |
| ⑪ A1335 | 3" Random Orbital Sander Skrit/Shroud | 28155 |
| ⑫A 20350 | 3M™ Hookit™ Clean Sanding Low Profile Disc Pad, 3" x 1/2" x 1/4-20 EXT, 3 Holes, Red Foam | 20350 |
| ⑫B 20353 | 3M™ Hookit™ Clean Sanding Low Profile Disc Pad, 5" x 3/8" x 5/16-24 EXT, 44 Holes, Red Foam | 20353 |
| ⑫C 20356 | 3M™ Hookit™ Clean Sanding Low Profile Disc Pad, 6" x 3/8" x 5/16-24 EXT, 52 Holes, Red Foam | 20356 |

| Optional | | |
|----------|---|-------|
| 28301 | Vacuum Hose, 1" ID x 6 ft. | 28301 |
| 28302 | Vacuum Hose Adaptor, 1" INT Hose Thread | 28302 |
| A1434 | Vacuum Bag Cover, 20" x 9" | 28303 |
| 20338 | Vacuum Bag Inserts | 20338 |

UPC Index

| UPC | Page | UPC | Page | UPC | Page | UPC | Page |
|----------------|------|----------------|--------|----------------|--------|----------------|--------|
| 048011-03764-6 | 63 | 048011-30201-0 | 40 | 051115-06524-8 | 10 | 051131-05670-1 | 55 |
| 048011-03767-7 | 63 | 048011-33521-6 | 28 | 051115-06528-6 | 8 | 051131-05671-8 | 59 |
| 048011-03768-4 | 63 | 048011-33608-4 | 54 | 051115-06529-3 | 8 | 051131-05672-5 | 59 |
| 048011-04013-4 | 54 | 048011-33732-6 | 40 | 051115-06530-9 | 8 | 051131-05684-8 | 55 |
| 048011-04018-9 | 62 | 048011-33733-3 | 40 | 051115-06540-8 | 8 | 051131-05685-5 | 55 |
| 048011-04019-6 | 15 | 048011-33734-0 | 40 | 051115-06541-5 | 8 | 051131-05686-2 | 55 |
| 048011-04020-2 | 61 | 048011-33966-5 | 51 | 051115-06544-6 | 10 | 051131-05687-9 | 55 |
| 048011-04021-9 | 62 | 048011-91136-6 | 51 | 051115-06545-3 | 8 | 051131-05688-6 | 55 |
| 048011-04130-8 | 20 | 051111-10132-2 | 66 | 051115-06546-0 | 8 | 051131-05689-3 | 55 |
| 048011-04132-2 | 20 | 051111-50193-1 | 44 | 051115-06569-9 | 10 | 051131-05690-9 | 55 |
| 048011-05673-9 | 20 | 051111-50197-9 | 57 | 051115-06573-6 | 8 | 051131-05691-6 | 55 |
| 048011-05674-6 | 21 | 051111-50198-6 | 46 | 051115-06574-3 | 8 | 051131-05692-3 | 59 |
| 048011-05677-7 | 21 | 051111-50199-3 | 46 | 051115-06575-0 | 8 | 051131-05693-0 | 59 |
| 048011-05680-7 | 21 | 051111-51042-1 | 24, 29 | 051115-06576-7 | 8 | 051131-05694-7 | 59 |
| 048011-05681-4 | 21 | 051111-51043-8 | 44 | 051115-06577-4 | 8 | 051131-05695-4 | 59 |
| 048011-05682-1 | 21 | 051111-51045-2 | 52 | 051115-06585-9 | 9 | 051131-05696-1 | 59 |
| 048011-05717-0 | 54 | 051111-51046-9 | 52 | 051115-06586-6 | 10 | 051131-05717-3 | 45 |
| 048011-05969-3 | 63 | 051111-51047-6 | 19 | 051115-06590-3 | 9 | 051131-05718-0 | 45 |
| 048011-07491-7 | 61 | 051111-51076-6 | 43 | 051115-06610-8 | 10 | 051131-05723-4 | 45 |
| 048011-07492-4 | 20 | 051111-51150-3 | 46 | 051115-28108-2 | 10 | 051131-05725-8 | 45 |
| 048011-07494-8 | 20 | 051111-51151-0 | 43 | 051115-28134-1 | 11 | 051131-05726-5 | 47 |
| 048011-09448-9 | 21 | 051111-51155-8 | 35 | 051115-28146-4 | 3 | 051131-05727-2 | 47 |
| 048011-09449-6 | 21 | 051111-51157-2 | 42 | 051115-28147-1 | 10 | 051131-05729-6 | 45 |
| 048011-09450-2 | 21 | 051111-51158-9 | 43 | 051115-66901-9 | 10 | 051131-05740-1 | 55 |
| 048011-09451-9 | 21 | 051111-51168-8 | 46 | 051115-66902-6 | 10 | 051131-05741-8 | 55 |
| 048011-09493-4 | 54 | 051111-55764-8 | 22 | 051115-66905-7 | 6 | 051131-05742-5 | 55 |
| 048011-12929-7 | 54 | 051111-55765-5 | 36 | 051115-66906-4 | 6 | 051131-05744-9 | 56 |
| 048011-13928-9 | 61 | 051111-55766-2 | 54 | 051122-01811-4 | 7 | 051131-05746-3 | 57 |
| 048011-13966-1 | 62 | 051111-55813-3 | 31 | 051122-01812-1 | 7 | 051131-05748-7 | 57 |
| 048011-13967-8 | 62 | 051111-55833-1 | 46 | 051131-02513-4 | 53 | 051131-05750-0 | 57 |
| 048011-13968-5 | 62 | 051111-55845-4 | 60 | 051131-05207-9 | 56 | 051131-05751-7 | 45 |
| 048011-14111-4 | 21 | 051111-55846-1 | 60 | 051131-05208-6 | 56 | 051131-05759-3 | 45 |
| 048011-14114-5 | 21 | 051111-56445-5 | 53 | 051131-05209-3 | 56 | 051131-05760-9 | 45 |
| 048011-14915-8 | 40 | 051111-56453-0 | 53 | 051131-05215-4 | 56 | 051131-05768-5 | 23 |
| 048011-15012-3 | 62 | 051111-56459-2 | 32 | 051131-05216-1 | 56 | 051131-05771-5 | 28 |
| 048011-15059-8 | 40 | 051111-56462-2 | 58 | 051131-05520-9 | 53 | 051131-05775-3 | 22, 29 |
| 048011-15060-4 | 40 | 051111-56472-1 | 31 | 051131-05526-1 | 58 | 051131-05777-7 | 28 |
| 048011-15408-4 | 40 | 051111-56479-0 | 39 | 051131-05538-4 | 35 | 051131-05779-1 | 23 |
| 048011-16859-3 | 51 | 051111-56491-2 | 27 | 051131-05541-4 | 35 | 051131-05780-7 | 24 |
| 048011-16860-9 | 51 | 051111-56493-6 | 54 | 051131-05545-2 | 29, 31 | 051131-05781-4 | 24 |
| 048011-17157-9 | 63 | 051111-56573-5 | 19 | 051131-05546-9 | 29, 31 | 051131-05782-1 | 24 |
| 048011-18444-9 | 23 | 051111-56599-5 | 62 | 051131-05551-3 | 26 | 051131-05783-8 | 24 |
| 048011-22970-6 | 14 | 051111-60306-2 | 18 | 051131-05568-1 | 31 | 051131-05791-3 | 54 |
| 048011-22971-3 | 14 | 051111-60311-6 | 25 | 051131-05581-0 | 30 | 051131-05792-0 | 55 |
| 048011-22972-0 | 14 | 051111-60527-1 | 43 | 051131-05582-7 | 30 | 051131-05848-4 | 57 |
| 048011-26224-1 | 45 | 051111-60528-8 | 43 | 051131-05589-6 | 58 | 051131-05855-2 | 24, 29 |
| 048011-27628-1 | 15 | 051111-60537-0 | 42 | 051131-05591-9 | 58 | 051131-05858-3 | 26 |
| 048011-27680-9 | 15 | 051111-60788-6 | 60 | 051131-05637-4 | 19 | 051131-05865-1 | 26 |
| 048011-30095-5 | 15 | 051111-60799-2 | 43 | 051131-05645-9 | 29, 30 | 051131-05876-7 | 24, 29 |
| 048011-30096-2 | 15 | 051111-61009-1 | 42 | 051131-05646-6 | 29, 30 | 051131-06002-9 | 41 |
| 048011-30133-4 | 15 | 051111-61104-3 | 42 | 051131-05668-8 | 59 | 051131-06025-8 | 50 |
| 048011-30134-1 | 15 | 051115-06522-4 | 10 | 051131-05669-5 | 59 | 051131-06026-5 | 50 |

UPC Index

| UPC | Page | UPC | Page | UPC | Page | UPC | Page |
|----------------|------|----------------|--------|----------------|--------|----------------|------|
| 051131-06027-2 | 50 | 051135-92689-5 | 51 | 051141-20453-6 | 3 | 051141-28402-6 | 9 |
| 051131-06039-5 | 49 | 051141-20206-8 | 26 | 051141-20454-3 | 29, 30 | 051141-28409-5 | 21 |
| 051131-06044-9 | 49 | 051141-20207-5 | 42 | 051141-20465-9 | 26, 29 | 051141-28410-1 | 44 |
| 051131-06045-6 | 49 | 051141-20209-9 | 2 | 051141-20466-6 | 2 | 051141-28411-8 | 24 |
| 051131-06046-3 | 49 | 051141-20215-0 | 10 | 051141-20467-3 | 2 | 051141-28416-3 | 18 |
| 051131-06075-3 | 41 | 051141-20216-7 | 7 | 051141-25119-6 | 2 | 051141-28417-0 | 18 |
| 051131-07390-6 | 24 | 051141-20217-4 | 7 | 051141-25122-6 | 24, 29 | 051141-28418-7 | 19 |
| 051131-07394-4 | 23 | 051141-20218-1 | 7 | 051141-25132-5 | 51 | 051141-28419-4 | 14 |
| 051131-07493-4 | 20 | 051141-20221-1 | 7 | 051141-25134-9 | 43 | 051141-28434-7 | 3 |
| 051131-07498-9 | 63 | 051141-20222-8 | 7 | 051141-25135-6 | 43 | 051141-28435-4 | 3 |
| 051131-07499-6 | 63 | 051141-20223-5 | 6 | 051141-27819-5 | 14 | 051141-28436-1 | 3 |
| 051131-07500-9 | 40 | 051141-20242-6 | 25 | 051141-27884-1 | 23 | 051141-28441-5 | 57 |
| 051131-07501-6 | 63 | 051141-20245-7 | 21 | 051141-28301-2 | 13 | 051141-28442-2 | 18 |
| 051131-07502-3 | 63 | 051141-20246-4 | 2 | 051141-28302-9 | 12 | 051141-28443-9 | 17 |
| 051131-07517-7 | 63 | 051141-20247-1 | 3 | 051141-28303-6 | 12 | 051141-28472-9 | 22 |
| 051131-07545-0 | 40 | 051141-20248-8 | 23 | 051141-28304-3 | 12 | 051141-28473-6 | 39 |
| 051131-07547-4 | 40 | 051141-20256-3 | 7 | 051141-28317-3 | 6 | 051141-28474-3 | 37 |
| 051131-07715-7 | 35 | 051141-20271-6 | 43 | 051141-28318-0 | 7 | 051141-28475-0 | 37 |
| 051131-07909-0 | 66 | 051141-20272-3 | 42 | 051141-28319-7 | 11 | 051141-28476-7 | 18 |
| 051131-07910-6 | 66 | 051141-20274-7 | 43 | 051141-28320-3 | 11 | 051141-28477-4 | 18 |
| 051131-09004-0 | 49 | 051141-20278-5 | 28 | 051141-28321-0 | 28 | 051141-28478-1 | 3 |
| 051131-09005-7 | 48 | 051141-20279-2 | 21 | 051141-28322-7 | 28 | 051141-28531-3 | 27 |
| 051131-09006-4 | 48 | 051141-20290-7 | 26, 29 | 051141-28323-4 | 28 | 051141-28548-1 | 23 |
| 051131-09007-1 | 48 | 051141-20338-6 | 12 | 051141-28324-1 | 28 | 051141-28574-0 | 43 |
| 051131-09009-5 | 47 | 051141-20340-9 | 12 | 051141-28325-8 | 27 | 051141-28580-1 | 39 |
| 051131-09010-1 | 47 | 051141-20341-6 | 12 | 051141-28326-5 | 28 | 051141-28581-8 | 39 |
| 051131-09011-8 | 47 | 051141-20342-3 | 5 | 051141-28348-7 | 65 | 051141-28584-9 | 46 |
| 051131-09019-4 | 48 | 051141-20343-0 | 5 | 051141-28349-4 | 65 | 051141-28605-1 | 7 |
| 051131-09020-0 | 47 | 051141-20344-7 | 5 | 051141-28364-7 | 3 | 051141-28606-8 | 7 |
| 051131-09023-1 | 49 | 051141-20348-5 | 31 | 051141-28365-4 | 3 | 051141-28607-5 | 7 |
| 051131-09030-9 | 49 | 051141-20350-8 | 26 | 051141-28368-5 | 4 | 051141-28608-2 | 7 |
| 051131-09033-0 | 47 | 051141-20351-5 | 29, 31 | 051141-28369-2 | 4 | 051141-28609-9 | 7 |
| 051131-09034-7 | 47 | 051141-20352-2 | 23, 29 | 051141-28370-8 | 4 | 051141-28610-5 | 7 |
| 051131-09047-7 | 47 | 051141-20353-9 | 26, 29 | 051141-28371-5 | 4 | 051141-28611-2 | 7 |
| 051131-09048-4 | 48 | 051141-20354-6 | 29, 31 | 051141-28372-2 | 4 | 051141-28612-9 | 7 |
| 051131-09061-3 | 49 | 051141-20355-3 | 23, 29 | 051141-28373-9 | 4 | 051141-28613-6 | 7 |
| 051131-09062-0 | 49 | 051141-20356-0 | 26, 29 | 051141-28374-6 | 4 | 051141-28614-3 | 7 |
| 051131-09063-7 | 48 | 051141-20425-3 | 26, 29 | 051141-28375-3 | 4 | 051141-28625-9 | 17 |
| 051131-09065-1 | 48 | 051141-20427-7 | 26 | 051141-28376-0 | 4 | 051141-28626-6 | 18 |
| 051131-09067-5 | 48 | 051141-20428-4 | 26 | 051141-28377-7 | 4 | 051141-28632-7 | 13 |
| 051131-09082-8 | 56 | 051141-20432-1 | 32 | 051141-28378-4 | 4 | 051141-28636-5 | 15 |
| 051131-09089-7 | 47 | 051141-20433-8 | 25 | 051141-28379-1 | 4 | 051141-28637-2 | 15 |
| 051131-16896-1 | 48 | 051141-20434-5 | 32 | 051141-28380-7 | 4 | 051141-28651-8 | 13 |
| 051131-16904-3 | 49 | 051141-20435-2 | 27 | 051141-28381-4 | 4 | 051141-28652-5 | 13 |
| 051131-35928-4 | 48 | 051141-20439-0 | 21 | 051141-28382-1 | 4 | 051141-28653-2 | 8 |
| 051131-35929-1 | 48 | 051141-20442-0 | 29, 30 | 051141-28383-8 | 3 | 051141-28654-9 | 19 |
| 051131-36044-0 | 49 | 051141-20443-7 | 28 | 051141-28384-5 | 54 | 051141-28655-6 | 25 |
| 051131-36045-7 | 49 | 051141-20444-4 | 28 | 051141-28385-2 | 61 | 051141-28656-3 | 17 |
| 051131-37716-5 | 45 | 051141-20445-1 | 28 | 051141-28393-7 | 13 | 051141-28657-0 | 17 |
| 051131-37720-2 | 45 | 051141-20446-8 | 28 | 051141-28394-4 | 6 | 051141-28658-7 | 17 |
| 051135-92499-0 | 46 | 051141-20451-2 | 2 | 051141-28395-1 | 9 | 051141-28660-0 | 32 |
| 051135-92500-3 | 43 | 051141-20452-9 | 3 | 051141-28401-9 | 43 | 051141-28661-7 | 31 |

UPC Index

| UPC | Page | UPC | Page | UPC | Page | UPC | Page |
|----------------|--------|----------------|--------|----------------|------|----------------|--------|
| 051141-28662-4 | 22 | 051141-55100-5 | 9 | 051144-14212-5 | 38 | 051144-45138-8 | 64 |
| 051141-28695-2 | 41 | 051141-55106-7 | 13 | 051144-14215-6 | 38 | 051144-45139-5 | 64 |
| 051141-28696-9 | 42 | 051141-55108-1 | 13 | 051144-14216-3 | 38 | 051144-45144-9 | 64 |
| 051141-28709-6 | 23, 29 | 051141-55109-8 | 13 | 051144-14270-5 | 16 | 051144-45145-6 | 64 |
| 051141-28710-2 | 39 | 051141-55115-9 | 11 | 051144-14307-8 | 61 | 051144-45146-3 | 64 |
| 051141-28711-9 | 39 | 051141-55146-3 | 5 | 051144-14308-5 | 61 | 051144-45148-7 | 64 |
| 051141-28712-6 | 37 | 051141-55180-7 | 2 | 051144-14736-6 | 46 | 051144-45152-4 | 64 |
| 051141-28713-3 | 37 | 051141-55204-0 | 5 | 051144-14738-0 | 42 | 051144-45153-1 | 64 |
| 051141-28714-0 | 37 | 051141-55205-7 | 5 | 051144-28576-4 | 38 | 051144-45156-2 | 64 |
| 051141-28718-8 | 65 | 051141-55206-4 | 5 | 051144-28577-1 | 38 | 051144-45159-3 | 64 |
| 051141-28725-6 | 10 | 051141-55434-1 | 6 | 051144-28578-8 | 38 | 051144-45179-1 | 36 |
| 051141-28726-3 | 4 | 051141-55435-8 | 6 | 051144-28579-5 | 38 | 051144-45188-3 | 58 |
| 051141-28727-0 | 14 | 051141-55436-5 | 6 | 051144-45032-9 | 51 | 051144-45189-0 | 58 |
| 051141-28728-7 | 14 | 051141-55437-2 | 6 | 051144-45033-6 | 51 | 051144-45190-6 | 18 |
| 051141-28730-0 | 12 | 051141-55752-6 | 8 | 051144-45034-3 | 51 | 051144-45194-4 | 16 |
| 051141-28738-6 | 46 | 051141-55772-4 | 8 | 051144-45035-0 | 51 | 051144-45198-2 | 58 |
| 051141-28739-3 | 9 | 051141-55788-5 | 10 | 051144-45038-1 | 14 | 051144-45203-3 | 58 |
| 051141-28740-9 | 9 | 051144-05440-4 | 58 | 051144-45068-8 | 33 | 051144-45204-0 | 58 |
| 051141-28741-6 | 14 | 051144-05441-1 | 58 | 051144-45069-5 | 33 | 051144-45205-7 | 18 |
| 051141-28742-3 | 39 | 051144-05442-8 | 58 | 051144-45070-1 | 33 | 051144-45208-8 | 16 |
| 051141-28743-0 | 14 | 051144-05444-2 | 56 | 051144-45071-8 | 33 | 051144-45215-6 | 29, 31 |
| 051141-28751-5 | 39 | 051144-05448-0 | 57 | 051144-45072-5 | 33 | 051144-45217-0 | 29, 30 |
| 051141-28752-2 | 39 | 051144-05450-3 | 32 | 051144-45073-2 | 33 | 051144-45218-7 | 29, 30 |
| 051141-28753-9 | 39 | 051144-05452-7 | 32 | 051144-45074-9 | 33 | 051144-76848-6 | 47 |
| 051141-28754-6 | 31 | 051144-05510-4 | 33 | 051144-45081-7 | 14 | 051144-77340-4 | 41 |
| 051141-28768-3 | 46 | 051144-05517-3 | 65 | 051144-45090-9 | 36 | 051144-77717-4 | 65 |
| 051141-28772-0 | 29, 31 | 051144-05518-0 | 65 | 051144-45091-6 | 36 | 051144-77718-1 | 65 |
| 051141-28777-5 | 54 | 051144-05519-7 | 53 | 051144-45092-3 | 36 | 051144-77720-4 | 65 |
| 051141-30324-6 | 12 | 051144-05530-2 | 58 | 051144-45093-0 | 36 | 051144-77721-1 | 65 |
| 051141-30331-4 | 6 | 051144-05539-5 | 35 | 051144-45094-7 | 36 | 051144-77722-8 | 65 |
| 051141-30334-5 | 9 | 051144-05540-1 | 35 | 051144-45095-4 | 35 | 051144-77723-5 | 37 |
| 051141-30364-2 | 9 | 051144-05575-3 | 29, 31 | 051144-45096-1 | 35 | 051144-77724-2 | 38 |
| 051141-30437-3 | 10 | 051144-05579-1 | 31 | 051144-45097-8 | 35 | 051144-77726-6 | 37 |
| 051141-30439-7 | 12 | 051144-05585-2 | 58 | 051144-45098-5 | 35 | 051144-77728-0 | 38 |
| 051141-30440-3 | 12 | 051144-05586-9 | 58 | 051144-45099-2 | 35 | 051144-77729-7 | 38 |
| 051141-30441-0 | 12 | 051144-05620-0 | 19 | 051144-45100-5 | 35 | 051144-77733-4 | 38 |
| 051141-30442-7 | 13 | 051144-05621-7 | 19 | 051144-45101-2 | 35 | 051144-77737-2 | 38 |
| 051141-30443-4 | 7 | 051144-05622-4 | 19 | 051144-45102-9 | 34 | 051144-77740-2 | 38 |
| 051141-30444-1 | 7 | 051144-05710-8 | 45 | 051144-45116-6 | 60 | 051144-77749-5 | 53 |
| 051141-30445-8 | 7 | 051144-11063-6 | 58 | 051144-45117-3 | 60 | 051144-77750-1 | 54 |
| 051141-30670-4 | 5 | 051144-11823-6 | 18 | 051144-45118-0 | 60 | 051144-77751-8 | 23 |
| 051141-30671-1 | 4 | 051144-11824-3 | 18 | 051144-45119-7 | 60 | 051144-77752-5 | 54 |
| 051141-30672-8 | 10 | 051144-13084-9 | 41 | 051144-45120-3 | 60 | 051144-77855-3 | 23, 29 |
| 051141-30673-5 | 11 | 051144-13325-3 | 16 | 051144-45121-0 | 61 | 051144-77856-0 | 24, 29 |
| 051141-30674-2 | 11 | 051144-13441-0 | 46 | 051144-45123-4 | 64 | 051144-80514-3 | 17 |
| 051141-30831-9 | 10 | 051144-13442-7 | 46 | 051144-45124-1 | 64 | 051144-80515-0 | 17 |
| 051141-30832-6 | 11 | 051144-13627-8 | 23 | 051144-45127-2 | 64 | 051144-80516-7 | 17 |
| 051141-30933-0 | 5 | 051144-14197-5 | 37 | 051144-45129-6 | 64 | 051144-81235-6 | 41 |
| 051141-30948-4 | 10 | 051144-14198-2 | 37 | 051144-45130-2 | 64 | 051144-81470-1 | 44 |
| 051141-55081-7 | 11 | 051144-14201-9 | 37 | 051144-45131-9 | 64 | 051144-81471-8 | 44 |
| 051141-55082-4 | 9 | 051144-14202-6 | 37 | 051144-45132-6 | 64 | 051144-81728-3 | 17 |
| 051141-55085-5 | 9 | 051144-14211-8 | 38 | 051144-45137-1 | 64 | 051144-81729-0 | 17 |

UPC Index

| UPC | Page | UPC | Page | UPC | Page | UPC | Page |
|----------------|--------|----------------|------|----------------|--------|----------------|------|
| 051144-81732-0 | 17 | 051144-82705-3 | 53 | 051144-84998-7 | 36 | 051144-85105-8 | 22 |
| 051144-81733-7 | 17 | 051144-82793-0 | 60 | 051144-84999-4 | 36 | 051144-85287-1 | 25 |
| 051144-81734-4 | 17 | 051144-82877-7 | 41 | 051144-85000-6 | 36 | 051144-88739-2 | 22 |
| 051144-81821-1 | 29, 31 | 051144-82878-4 | 41 | 051144-85001-3 | 36 | 051144-88741-5 | 53 |
| 051144-82178-5 | 31 | 051144-82880-7 | 22 | 051144-85004-4 | 62 | 051144-88743-9 | 18 |
| 051144-82189-1 | 31 | 051144-82974-3 | 39 | 051144-85078-5 | 44 | 051144-88748-4 | 36 |
| 051144-82191-4 | 53 | 051144-82975-0 | 39 | 051144-85079-2 | 44 | 051144-88749-1 | 60 |
| 051144-82271-3 | 46 | 051144-83058-9 | 41 | 051144-85083-9 | 44 | 051144-88753-8 | 41 |
| 051144-82455-7 | 34 | 051144-83242-2 | 36 | 051144-85084-6 | 44 | 051144-88765-1 | 52 |
| 051144-82457-1 | 53 | 051144-83489-1 | 37 | 051144-85095-2 | 54 | 051144-88769-9 | 52 |
| 051144-82531-8 | 44 | 051144-83497-6 | 56 | 051144-85096-9 | 22 | 134375-38286-1 | 43 |
| 051144-82564-6 | 25 | 051144-83978-0 | 56 | 051144-85097-6 | 61 | 134375-38287-8 | 43 |
| 051144-82565-3 | 25 | 051144-83980-3 | 36 | 051144-85099-0 | 44 | | |
| 051144-82566-0 | 25 | 051144-84229-2 | 58 | 051144-85100-3 | 44 | | |
| 051144-82567-7 | 25 | 051144-84993-2 | 36 | 051144-85103-4 | 44 | | |
| 051144-82659-9 | 24, 29 | 051144-84994-9 | 36 | 051144-85104-1 | 29, 31 | | |

Part No. Index

| Part No. | Page | Part No. | Page | Part No. | Page | Part No. | Page | Part No. | Page | Part No. | Page |
|----------|------|----------|--------|----------|--------|----------|--------|----------|------|----------|------|
| 01811 | 7 | 05440 | 58 | 05620 | 19 | 05727 | 47 | 06025 | 50 | 07390 | 24 |
| 01812 | 7 | 05441 | 58 | 05621 | 19 | 05729 | 45 | 06026 | 50 | 07394 | 23 |
| 01904 | 53 | 05442 | 58 | 05622 | 19 | 5730 | 44 | 06027 | 50 | 07498 | 63 |
| 01908 | 54 | 05444 | 56 | 05637 | 19 | 05740 | 55 | 06039 | 49 | 07499 | 63 |
| 01912 | 43 | 05448 | 57 | 05645 | 29, 30 | 05741 | 55 | 06044 | 49 | 07500 | 40 |
| 01927 | 44 | 05450 | 32 | 05646 | 29, 30 | 05742 | 55 | 06045 | 49 | 07501 | 63 |
| 01963 | 43 | 05452 | 32 | 05668 | 59 | 05744 | 56 | 06046 | 49 | 07502 | 63 |
| 02021 | 45 | 05510 | 33 | 05669 | 59 | 05746 | 57 | 06075 | 41 | 07517 | 63 |
| 02140 | 19 | 05517 | 65 | 05670 | 55 | 05748 | 57 | 06522 | 10 | 07545 | 40 |
| 02286 | 39 | 05518 | 65 | 05671 | 59 | 05750 | 57 | 06524 | 10 | 07547 | 40 |
| 02345 | 46 | 05519 | 53 | 05672 | 59 | 05751 | 45 | 06528 | 8 | 07715 | 35 |
| 02362 | 43 | 05520 | 53 | 05684 | 55 | 05759 | 45 | 06529 | 8 | 07909 | 66 |
| 02362B | 43 | 05526 | 58 | 05685 | 55 | 05760 | 45 | 06530 | 8 | 07910 | 66 |
| 02511 | 46 | 05530 | 58 | 05686 | 55 | 05768 | 23 | 06540 | 8 | 09004 | 49 |
| 02513 | 53 | 05538 | 35 | 05687 | 55 | 05771 | 28 | 06541 | 8 | 09005 | 48 |
| 02618 | 19 | 05539 | 35 | 05688 | 55 | 05775 | 22, 29 | 06541 | 62 | 09006 | 48 |
| 02637 | 43 | 05540 | 35 | 05689 | 55 | 05777 | 28 | 06544 | 10 | 09007 | 48 |
| 02648 | 43 | 05541 | 35 | 05690 | 55 | 05779 | 23 | 06545 | 8 | 09009 | 47 |
| 02648B | 43 | 05545 | 29, 31 | 05691 | 55 | 05780 | 24 | 06546 | 8 | 09010 | 47 |
| 02700 | 22 | 05546 | 29, 31 | 05692 | 59 | 05781 | 24 | 06569 | 10 | 09011 | 47 |
| 02712 | 60 | 05551 | 26 | 05693 | 59 | 05782 | 24 | 06573 | 8 | 09019 | 48 |
| 02713 | 60 | 05568 | 31 | 05694 | 59 | 05783 | 24 | 06574 | 8 | 09020 | 47 |
| 02727 | 46 | 05575 | 29, 31 | 05695 | 59 | 05791 | 54 | 06575 | 8 | 09023 | 49 |
| 02795 | 32 | 05579 | 31 | 05696 | 59 | 05792 | 55 | 06576 | 8 | 09030 | 49 |
| 03764 | 63 | 05581 | 30 | 05710 | 45 | 05848 | 57 | 06577 | 8 | 09033 | 47 |
| 05207 | 56 | 05582 | 30 | 05717 | 45 | 05855 | 24, 29 | 06585 | 9 | 09034 | 47 |
| 05208 | 56 | 05585 | 58 | 05718 | 45 | 05858 | 26 | 06586 | 10 | 09047 | 47 |
| 05209 | 56 | 05586 | 58 | 05723 | 45 | 05865 | 26 | 06590 | 9 | 09048 | 48 |
| 05215 | 56 | 05589 | 58 | 05725 | 45 | 05876 | 24, 29 | 06610 | 10 | 09061 | 49 |
| 05216 | 56 | 05591 | 58 | 05726 | 47 | 06002 | 41 | 06624 | 58 | 09062 | 49 |

Part No. Index

| Part No. | Page | Part No. | Page | Part No. | Page | Part No. | Page | Part No. | Page | Part No. | Page |
|----------|------------|----------|--------|----------|--------|----------|------|----------|------|----------|--------|
| 09063 | 48 | 7493 | 20 | 20341 | 12 | 28322 | 28 | 28576 | 38 | 28743 | 14 |
| 09065 | 48 | 9145 | 21 | 20342 | 5 | 28323 | 28 | 28577 | 38 | 28751 | 39 |
| 09067 | 48 | 9145 | 21 | 20343 | 5 | 28324 | 28 | 28578 | 38 | 28752 | 39 |
| 09082 | 56 | 9215 | 20 | 20344 | 5 | 28325 | 27 | 28579 | 38 | 28753 | 39 |
| 09089 | 47 | 10132NA | 66 | 20348 | 31 | 28326 | 28 | 28580 | 39 | 28754 | 31 |
| 09357 | 43 | 11063 | 58 | 20350 | 26 | 28348 | 65 | 28581 | 39 | 28768 | 46 |
| 09358 | 43 | 11823 | 18 | 20351 | 29, 31 | 28349 | 65 | 28584 | 46 | 28772 | 29, 31 |
| 1 | 40 | 11824 | 18 | 20352 | 23, 29 | 28364 | 3 | 28605 | 7 | 28777 | 54 |
| 2 | 40 | 13084 | 41 | 20353 | 26, 29 | 28365 | 3 | 28606 | 7 | 30133 | 15 |
| 3 | 15, 40, 51 | 13325 | 16 | 20354 | 29, 31 | 28368 | 4 | 28607 | 7 | 30134 | 15 |
| 4 | 40 | 13441 | 46 | 20355 | 23, 29 | 28369 | 4 | 28608 | 7 | 30201 | 40 |
| 5 | 51 | 13442 | 46 | 20356 | 26, 29 | 28370 | 4 | 28609 | 7 | 30324 | 12 |
| 6 | 40 | 14197 | 37 | 20425 | 26, 29 | 28371 | 4 | 28610 | 7 | 30331 | 6 |
| 7 | 40 | 14198 | 37 | 20427 | 26 | 28372 | 4 | 28611 | 7 | 30334 | 9 |
| 8 | 15 | 14201 | 37 | 20428 | 26 | 28373 | 4 | 28612 | 7 | 30364 | 9 |
| 9 | 14 | 14202 | 37 | 20432 | 32 | 28374 | 4 | 28613 | 7 | 30437 | 10 |
| 250 | 54 | 14211 | 38 | 20433 | 25 | 28375 | 4 | 28614 | 7 | 30439 | 12 |
| 250BP | 54 | 14212 | 38 | 20434 | 32 | 28376 | 4 | 28625 | 17 | 30440 | 12 |
| 250HD | 54 | 14215 | 38 | 20435 | 27 | 28377 | 4 | 28626 | 18 | 30441 | 12 |
| 261 | 54 | 14216 | 38 | 20439 | 21 | 28378 | 4 | 28632 | 13 | 30442 | 13 |
| 300 | 15 | 14270 | 16 | 20442 | 29, 30 | 28379 | 4 | 28636 | 15 | 30443 | 7 |
| 905 | 21 | 14307 | 61 | 20443 | 28 | 28380 | 4 | 28637 | 15 | 30444 | 7 |
| 906 | 21 | 14308 | 61 | 20444 | 28 | 28381 | 4 | 28651 | 13 | 30445 | 7 |
| 914 | 20, 21 | 14736U | 46 | 20445 | 28 | 28382 | 4 | 28652 | 13 | 30662 | 5 |
| 915 | 21 | 14736V | 46 | 20446 | 28 | 28383 | 3 | 28653 | 8 | 30663 | 5 |
| 916 | 21 | 14738 | 42 | 20451 | 2 | 28385 | 61 | 28654 | 19 | 30664 | 5 |
| 917 | 21 | 16896 | 48 | 20452 | 3 | 28393 | 13 | 28655 | 25 | 30665 | 5 |
| 917M | 21 | 16904 | 49 | 20453 | 3 | 28394 | 6 | 28656 | 17 | 30666 | 5 |
| 918 | 21 | 17157 | 63 | 20454 | 29, 30 | 28395 | 9 | 28657 | 17 | 30667 | 5 |
| 922 | 20 | 18444 | 23 | 20465 | 26, 29 | 28401 | 43 | 28658 | 17 | 30668 | 5 |
| 923 | 20 | 20206 | 26 | 20466 | 2 | 28402 | 9 | 28660 | 32 | 30669 | 5 |
| 924 | 20 | 20209 | 2 | 20467 | 2 | 28410 | 44 | 28661 | 31 | 30670 | 5 |
| 931 | 62 | 20215 | 10 | 25119 | 2 | 28411 | 24 | 28662 | 22 | 30671 | 4 |
| 932 | 62 | 20216 | 7 | 25122 | 24, 29 | 28416 | 18 | 28695 | 41 | 30672 | 10 |
| 933 | 62 | 20217 | 7 | 25132 | 51 | 28417 | 18 | 28696 | 42 | 30673 | 11 |
| 934 | 62 | 20218 | 7 | 25134 | 43 | 28418 | 19 | 28710 | 39 | 30674 | 11 |
| 935 | 61 | 20221 | 7 | 25135 | 43 | 28419 | 14 | 28711 | 39 | 30831 | 10 |
| 936 | 62 | 20222 | 7 | 27628 | 15 | 28434 | 3 | 28712 | 37 | 30832 | 11 |
| 938 | 61 | 20223 | 6 | 27680 | 15 | 28435 | 3 | 28713 | 37 | 30933 | 5 |
| 944 | 61 | 20242 | 25 | 27884 | 23 | 28436 | 3 | 28714 | 37 | 30948 | 10 |
| 947 | 23 | 20245 | 21 | 28108 | 10 | 28441 | 57 | 28718 | 65 | 33521 | 28 |
| 947TH | 21 | 20246 | 2 | 28134 | 11 | 28442 | 18 | 28719 | 14 | 35928 | 48 |
| 952 | 54 | 20247 | 3 | 28146 | 3 | 28443 | 17 | 28725 | 10 | 35929 | 48 |
| 961 | 54 | 20248 | 23 | 28147 | 10 | 28472 | 22 | 28726 | 4 | 36044 | 49 |
| 990 | 62 | 20256 | 7 | 28301 | 13 | 28473 | 39 | 28727 | 14 | 36045 | 49 |
| A1434 | 12 | 20271 | 43 | 28302 | 12 | 28474 | 37 | 28728 | 14 | 37716 | 45 |
| 3125H | 42 | 20272 | 42 | 28304 | 12 | 28475 | 37 | 28730 | 12 | 37720 | 45 |
| 3125P | 42 | 20274 | 43 | 28317 | 6 | 28476 | 18 | 28738 | 46 | 45038 | 14 |
| 7210 | 63 | 20278 | 28 | 28318 | 7 | 28477 | 18 | 28739 | 9 | 45068 | 33 |
| 7211 | 63 | 20290 | 26, 29 | 28319 | 11 | 28478 | 3 | 28740 | 9 | 45069 | 33 |
| 7212 | 63 | 20338 | 12 | 28320 | 11 | 28531 | 27 | 28741 | 14 | 45070 | 33 |
| | | 20340 | 12 | 28321 | 28 | 28574 | 43 | 28742 | 39 | 45071 | 33 |

Part No. Index

| Part No. | Page | Part No. | Page | Part No. | Page | Part No. | Page | Part No. | Page | Part No. | Page |
|----------|------|----------|--------|----------|--------|----------|--------|----------|--------|----------|--------|
| 45072 | 33 | 45139 | 64 | 55108 | 13 | 77720 | 65 | 82191 | 53 | 85078 | 44 |
| 45073 | 33 | 45144 | 64 | 55109 | 13 | 77721 | 65 | 82271 | 46 | 85079 | 44 |
| 45074 | 33 | 45145 | 64 | 55115 | 11 | 77722 | 65 | 82455 | 34 | 85083 | 44 |
| 45081 | 14 | 45146 | 64 | 55146 | 5 | 77723 | 37 | 82457 | 53 | 85084 | 44 |
| 45090 | 36 | 45148 | 64 | 55180 | 2 | 77724 | 38 | 82531 | 44 | 85095 | 54 |
| 45091 | 36 | 45152 | 64 | 55204 | 5 | 77726 | 37 | 82564 | 25 | 85096 | 22 |
| 45092 | 36 | 45153 | 64 | 55205 | 5 | 77728 | 38 | 82565 | 25 | 85097 | 61 |
| 45093 | 36 | 45156 | 64 | 55206 | 5 | 77729 | 38 | 82566 | 25 | 85099 | 44 |
| 45094 | 36 | 45159 | 64 | 55434 | 6 | 77733 | 38 | 82567 | 25 | 85100 | 44 |
| 45095 | 35 | 45179 | 36 | 55435 | 6 | 77737 | 38 | 82659 | 24, 29 | 85103 | 44 |
| 45096 | 35 | 45188 | 58 | 55436 | 6 | 77740 | 38 | 82705 | 53 | 85104 | 29, 31 |
| 45097 | 35 | 45189 | 58 | 55437 | 6 | 77749 | 53 | 82793 | 60 | 85105 | 22 |
| 45098 | 35 | 45190 | 18 | 55752 | 8 | 77750 | 54 | 82877 | 41 | 85287 | 25 |
| 45099 | 35 | 45194 | 16 | 55772 | 8 | 77751 | 23 | 82878 | 41 | 86100 | 18 |
| 45100 | 35 | 45198 | 58 | 55788 | 10 | 77751B | 23 | 82879 | 36 | 88044 | 57 |
| 45101 | 35 | 45203 | 58 | 60150 | 42 | 77752 | 54 | 82880 | 22 | 88132 | 54 |
| 45102 | 34 | 45204 | 58 | 61104 | 42 | 77855 | 23, 29 | 82974 | 39 | 88739 | 22 |
| 45116 | 60 | 45205 | 18 | 66901 | 10 | 77856 | 24, 29 | 82975 | 39 | 88741 | 53 |
| 45117 | 60 | 45208 | 16 | 66902 | 10 | 80514 | 17 | 83058 | 41 | 88743 | 18 |
| 45118 | 60 | 45215 | 29, 31 | 66905 | 6 | 80515 | 17 | 83242 | 36 | 88748 | 36 |
| 45119 | 60 | 45217 | 29, 30 | 66906 | 6 | 80516 | 17 | 83489 | 37 | 88749 | 60 |
| 45120 | 60 | 45218 | 29, 30 | 67415 | 25 | 81235 | 41 | 83497 | 56 | 88753 | 41 |
| 45121 | 61 | 50199 | 46 | 70138 | 23, 29 | 81470 | 44 | 83978 | 56 | 88765 | 52 |
| 45123 | 64 | 51045 | 52 | 70147 | 53 | 81471 | 44 | 83980 | 36 | 88769 | 52 |
| 45124 | 64 | 51046 | 52 | 70166 | 27 | 81728 | 17 | 84226 | 24, 29 | 91136 | 51 |
| 45127 | 64 | 51056 | 42 | 70234 | 31 | 81729 | 17 | 84229 | 58 | 99736 | 60 |
| 45129 | 64 | 51155 | 35 | 70437 | 46 | 81732 | 17 | 84993 | 36 | | |
| 45130 | 64 | 55081 | 11 | 70449 | 31 | 81733 | 17 | 84994 | 36 | | |
| 45131 | 64 | 55082 | 9 | 76848 | 47 | 81734 | 17 | 84998 | 36 | | |
| 45132 | 64 | 55085 | 9 | 77340 | 41 | 81821 | 29, 31 | 84999 | 36 | | |
| 45137 | 64 | 55100 | 9 | 77717 | 65 | 82178 | 31 | 85000 | 36 | | |
| 45138 | 64 | 55106 | 13 | 77718 | 65 | 82189 | 31 | 85001 | 36 | | |



Contact your local 3M authorized distributor directly. For more information on a 3M distributor or sales representative in your area, contact us at the following number:

Contiguous 48 States..... 866-279-1235 (FAX 651-778-4244)

E-mail us at 3MIndustrial@mmm.com

For additional 3M product information or material data sheets contact us at:

866-279-1235

www.3M.com/abrasives

www.3M.com/AccessoriesASD

www.3M.com/SpareParts

Additional accessories are available and may be purchased directly through Contract Production Services/CPS. Please contact Contract Production Services/CPS directly to check availability and other specific information. Use the part number to identify and specify the desired item.

Contract Production Services/CPS

1936 Lyndale Avenue South
Minneapolis, MN 55403
www.cpsabrasives.com
cjones@contactcps.com

Toll Free: 1-800-843-0619
Tel: 612-843-3445
Fax: 612-872-0189

Office Hours: Monday–Thursday, 6:00 a.m.– 4:00 p.m. (Central Time)

Important Notice to Purchaser

Product Use: Many factors beyond 3M’s control and uniquely within user’s knowledge and control can affect the use and performance of a 3M product in a particular application. Given the variety of factors that can affect the use and performance of a 3M product, user is solely responsible for evaluating the 3M product and determining whether it is fit for a particular purpose and suitable for user’s method of application.

Warranty, Limited Remedy and Disclaimer: Unless an additional warranty is specifically stated on the applicable 3M product packaging or product literature, 3M warrants that each 3M product meets the applicable 3M product specification at the time 3M ships the product. 3M MAKES NO OTHER WARRANTIES OR CONDITIONS, EXPRESS OR IMPLIED, INCLUDING, BUT NOT LIMITED TO, ANY IMPLIED WARRANTY OR CONDITION OF MERCHANTABILITY OR FITNESS FOR A PARTICULAR PURPOSE OR ANY IMPLIED WARRANTY OR CONDITION ARISING OUT OF A COURSE OF DEALING, CUSTOM OR USAGE OF TRADE. If the 3M product does not conform to this warranty, then the sole and exclusive remedy is, at 3M’s option, replacement of the 3M product or refund of the purchase price.

Limitation of Liability: Except where prohibited by law, 3M will not be liable for any loss or damage arising from the 3M product, whether direct, indirect, special, incidental or consequential, regardless of the legal theory asserted, including warranty, contract, negligence or strict liability.



3M Abrasive Systems Division

3M Center, Building 223-6S-03
St. Paul, MN 55144-1000
1-866-279-1235
www.3M.com/abrasives

Please Recycle. Printed in U.S.A.
© 3M 2013. All rights reserved.
61-5002-8098-9 REV 2014

3M, Doodlebug, Dual Lock, Finesse-it, Hookit, Imperial, Insta-Lok, Perfect-it, Roloc, Scotch-Brite, Scotchgard, Stikit, Twist-Lok and Wetordry are all trademarks of 3M. Used under license in Canada. All other trademarks are the property of their respective owners.