



S93-650

Sentry™ Semi-Circular Shallow Bowl Washfountain

- Available with infrared, air, or TouchTime™
- Available in a 54" or 36" bowl size – wall-mounted or floor-mounted
- Standard height models and juvenile height 54" models with air (hand), infrared, or TouchTime® pushbutton and piezo are ADA/TAS compliant
- Factory tested and shipped pre-assembled
- Vandal resistant and easy to clean

Specifications

Size and Capacity

Accommodates 3 users (36" models) or 4 users (54" models) at a time, using less water, energy and space than lavs equipped with conventional faucets. The sectional sprayhead module is controlled by a push button, which actuates an air valve (hand or foot control models), or a solenoid valve (TouchTime® models) or by an infrared sensor-actuated solenoid. Flow restrictor keeps flow rate constant under any pressure. Operating range is 20-80 psi.

Construction

Bowl and Pedestal

All exposed materials are type 304 stainless steel polished to a #4 finish. Bowl, pedestal and access panels, frame, foot control housing; support tube; and sprayhead are heavy gauge stainless steel. Exposed fittings are chrome plated.

Vandal Resistance

Bowl and support tube are an integrally welded assembly, with the support tube welded to an extruded flange from bowl. Sprayhead nozzles and push buttons/infrared sensors are secured to unit from inside the sprayhead module. Air valves/solenoid valves are safely concealed inside the washfountain. Access panels are removable. All supply and waste connections are concealed within the pedestal.

Mounting Heights

Sentry washfountains can be installed at standard or juvenile height. Floor-mounted models require mounting height selection. Wall-mounted units are simply installed at the desired height.

Product Compliance

Listed by IAPMO R&T to

- Uniform Plumbing Code (UPC)
- National Plumbing Code of Canada
- International Plumbing Code (IPC)
- IGC 156 and the requirements of ASME A112.19.3/CSA B45.4 and ASME A112.18.1/CSA B125.1



Complies with

- ADA
- TAS
- ICC/ANSI 117.1 (54" STD & JUV height w/air metering hand, TouchTime, or infrared activation)



Listed by NSF International to

- NSF/ANSI 372



Standard Equipment

Valves and Fittings

In addition to the bowl and pedestal, the following valves and fittings are standard: Navigator® thermostatic mixing valve, flexible stainless steel supply hoses and stops. Stops are 1/2" compression female.

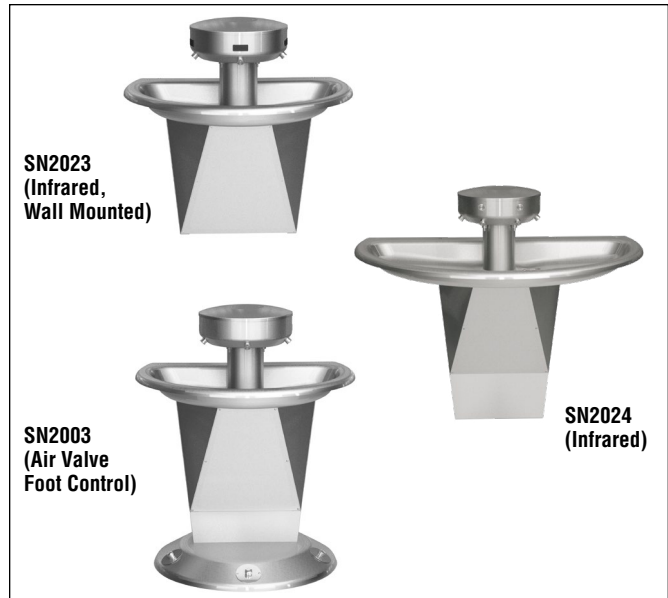

Activation Types

Air Hand Activation

Each pushbutton pneumatically actuates a non-hold-open, air metering, single-temperature valve with field adjustable timing from 0–45 seconds. Factory preset at 11 seconds. Each pushbutton activates one valve which, in turn, activates one station at a rate of 0.10 gpc (0.38 Lpc). Pushbutton requires less than five pounds of pressure.

Air - Hold-Open Foot Activation

Each pushbutton pneumatically actuates a hold-open, air single-temperature valve with slow closing upon release of foot pressure. Each pushbutton activates one valve, which in turn, activates one station at a rate of 0.50 gpm (1.9 Lpm). Pushbutton requires less than five pounds of pressure.

Infrared

Each of the streamformers is controlled by a separate slow-closing solenoid valve. Hands placed within the bowl are detected by an infrared sensor module, which activates a flow of tempered water from one spray nozzle at a rate of 0.50 gpm (1.9 Lpm). Shut-off is automatic after hands are removed from the detection area. The infrared sensor module uses two zone-focused infrared transmitting beams, having a detection area that does not exceed the bowl perimeter. The detection range projects 6–9 inches forward at a 30° angle to each side and reaches 15° below horizontal. The infrared sensor is not affected by varying color tones or darkness. Direct sunlight or bright washroom lights will not activate the system. Infrared models also include solenoid valves and a low voltage transform as standard equipment:

- Solenoid – 12V DC, 3/8" tube fitting. Few moving parts, and resistant to most chemicals, minerals, and impurities often present in municipal water supplies.
- Low-Voltage Plug-In Adapter – UL/CSA-Listed 120V AC/12V DC plug in adapter designed to plug into a standard GFCI protected electrical outlet. Location of plug-in adapter per local electrical code.

TouchTime®

Each low-voltage pushbutton or piezo switch actuates a non-hold-open, slow-closing, anti-hammer solenoid valve that is timed from an electronic potted assembly. Each pushbutton activates one valve which, in turn, activates one station flowing tempered water at a rate of 0.10 gpc (0.38 Lpc). TouchTime controls water flow at each station through the use of solid state, digital circuitry. Timing is factory set at a 11 second run time, but is field adjustable to pre-set time out periods and optional auto-flush function. The 24 hour flush function will activate water flow for a period of 60 seconds any time there has been no activation within the past 24 hours. Pushbutton requires less than five pounds of pressure.

© 2021 Bradley



S93-650

Sentry™ Semi-Circular Shallow Bowl Washfountain

Models (Must select one)			
Model	Size	Stations	Description
SN2003	36"	3	Floor-Mounted*
SN2004	54"	4	Floor-Mounted*
SN2023	36"	3	Wall-Mounted*
SN2024	54"	4	Wall-Mounted*

Standard Selections (Must select one from each category)			
Drain Type (select one)			
A	Off-line vent with supplies from below	H	Centrally rising vent with supplies from below
B	Centrally rising vent with supplies from above	O	Off-line vent with supplies from above
Mounting Height Type (Models SN2003 & SN2004 only) (select one)			
STD	Standard Height	JUV	Juvenile Height
Activation Type (select one)			
AST4	Air - Hand Activation	TTPA	TouchTime Pushbutton
IRP	Infrared	TTPB	TouchTime Piezo Switch
AST4-F	Air - Hold Open Foot Activation (SN2003 and SN2004 only)**		
Soap Dispenser Type (select one)			
LSD	Two Integral Liquid Soap Dispensers		
NSD	No Soap Dispenser		
Water Supply Type (select one)			
TMA	Thermostatic Mixing Valve	TL	Tempered Line Supply
NONE	No Water Supply		

Optional Selections			
Backsplash Type			
BS	Bolted On Backsplash		
NBS	No Backsplash		
Towel Dispenser Type			
CFTD	(2) C-Fold, Multi-Fold Dispenser	NONE	No Towel Dispenser
SFTD	(2) Single-Fold Dispenser		
Shroud Type (Models SN2003 & SN2004 Only)†			
SH	Stainless Steel Shroud (Conceals overhead plumbing) Floor to ceiling height _____ ft. _____ in.		
NONE	No Shroud		

NOTE: Floor to ceiling height is required; maximum height of 13 ft. 0 in. A height greater than the maximum height will be considered a special order.

* Models are ADA/TAS Compliant when mounted at standard or juvenile height dimensions with infrared, TouchTime, or air metering hand activation.

** Non-cancelable, not-returnable

† Shroud is recommended for drain type B, H, and O to conceal vent and/or supplies.

Rough-In Dimensions for Bowl and Pedestal Wall Anchors (mm)

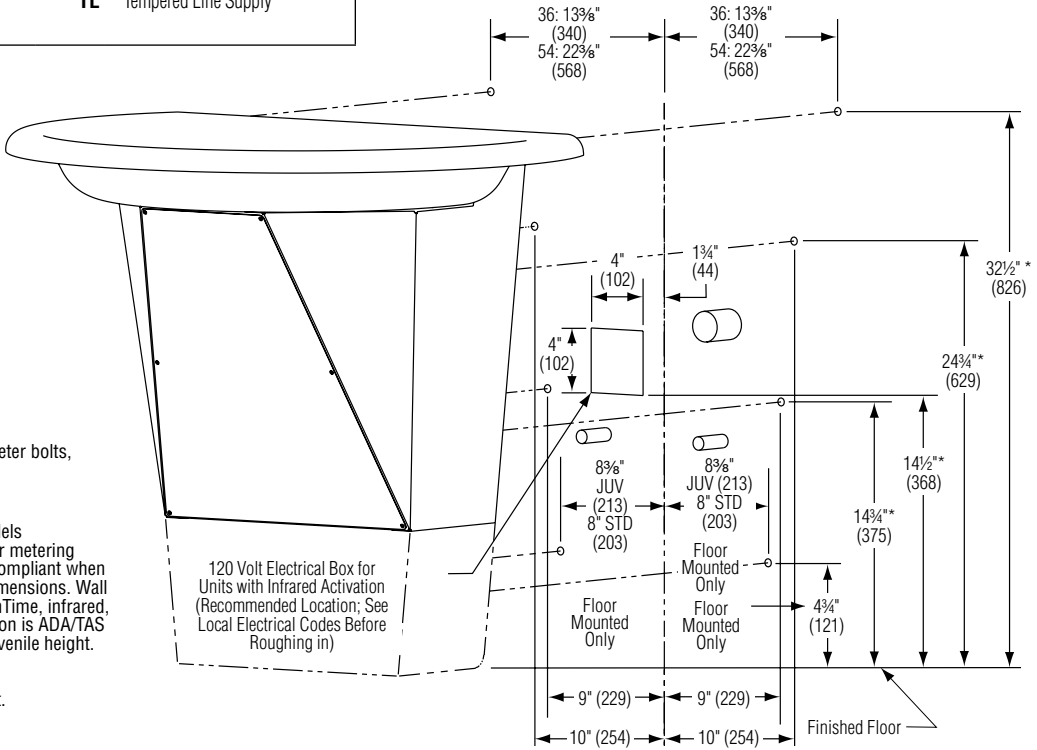

Rough-In Notes
Anchor locations for 3/8" diameter bolts, both supplied by installer.



Wall mounted 54" and 36" models with TouchTime, infrared, or air metering hand activation are ADA/TAS compliant when mounted at standard height dimensions. Wall mounted 54" model with TouchTime, infrared, or hand metering hand activation is ADA/TAS compliant when mounted at juvenile height.

* Subtract 4" (102) from this dimension for juvenile height.



S93-650

Sentry™ Semi-Circular Shallow Bowl Washfountain

Dimensions - Sentry™ 54" Floor Mounted

Dimensions - Sentry™ 36" Floor Mounted

(mm)

Infrared Activation

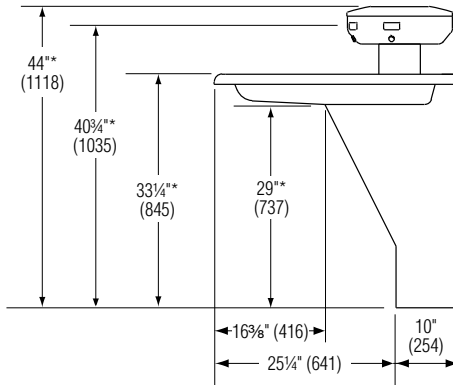

Infrared Activation

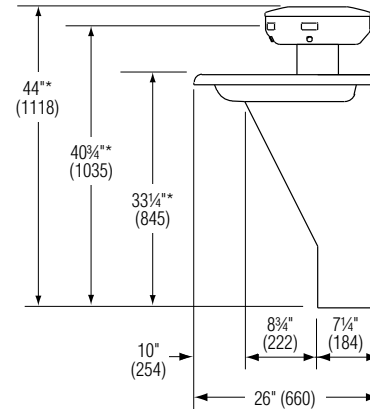

Hand Activation (AST4 and TouchTime)

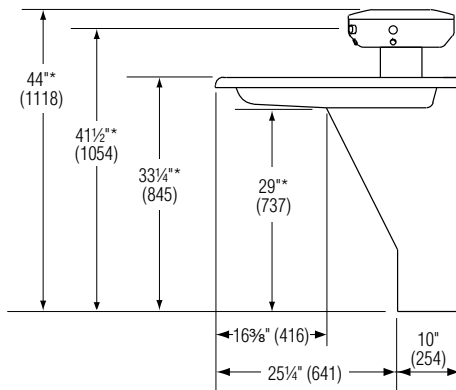

Hand Activation (AST4 and TouchTime)

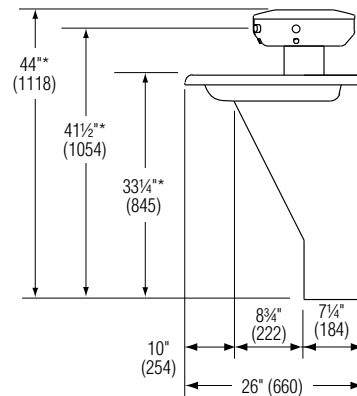

Air Valve - Hold Open Foot Activation

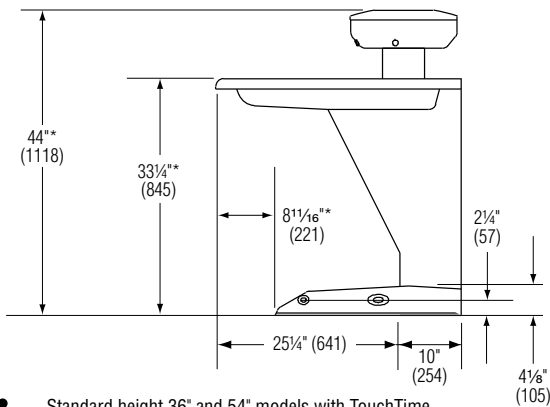

Air Valve - Hold Open Foot Activation

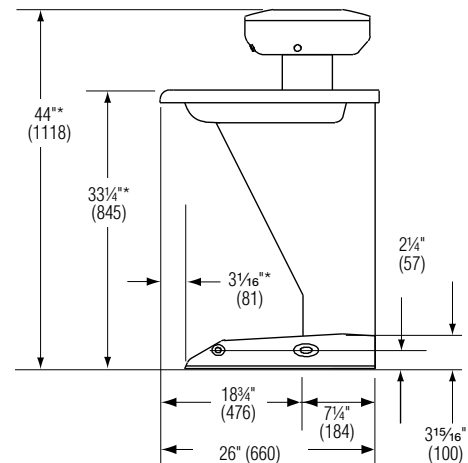

Standard height 36" and 54" models with TouchTime, infrared, or air metering hand activation are ADA/TAS compliant when mounted at standard height dimensions. Juvenile height 54" model with TouchTime, infrared, or air metering hand activation is ADA/TAS compliant.

* Subtract 4" (102) from this dimension for juvenile height.



S93-650

Sentry™ Semi-Circular Shallow Bowl Washfountain

Dimensions - Sentry 54" and 36" Wall Mounted

(mm)

54" Infrared Activation

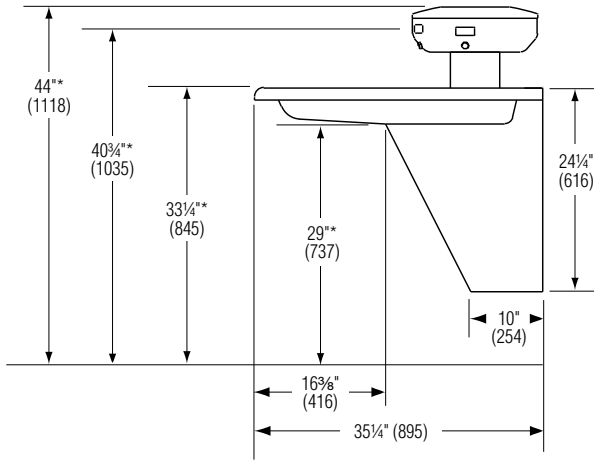

54" Hand Activation (AST4 and TouchTime)

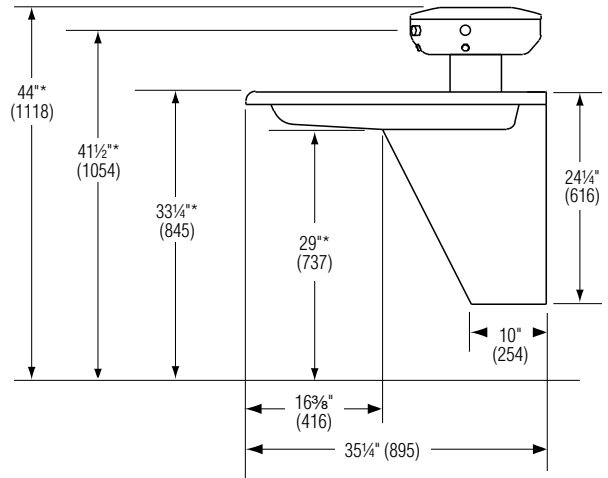

36" Infrared Activation

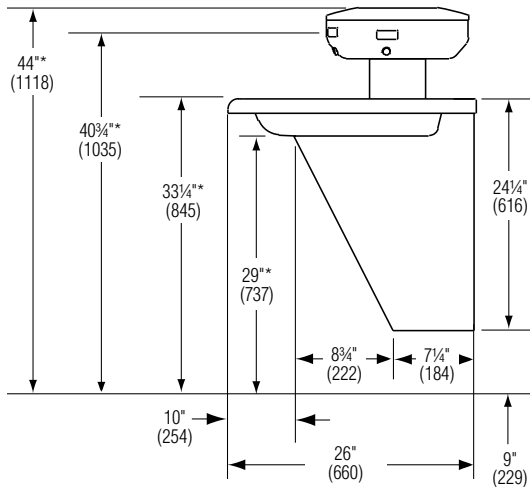

36" Hand Activation (AST4 and TouchTime)

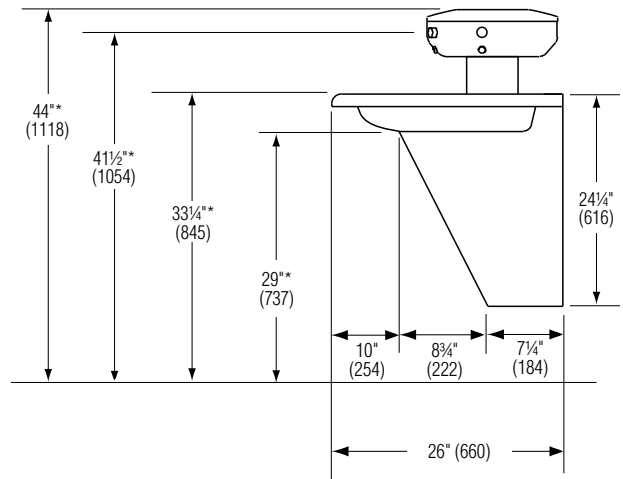

Wall mounted 54" and 36" models with TouchTime, infrared, or air metering hand activation are ADA/TAS compliant when mounted at standard height dimensions. Wall mounted 54" model with TouchTime, infrared, or air metering hand activation is ADA/TAS compliant when mounted at juvenile height.

* Subtract 4" (102) from this dimension for juvenile height.



S93-650

Sentry™ Semi-Circular Shallow Bowl Washfountain

Rough-In Dimensions for Drain and Supplies

(mm)

Type A

– Off-line vent with supplies from below

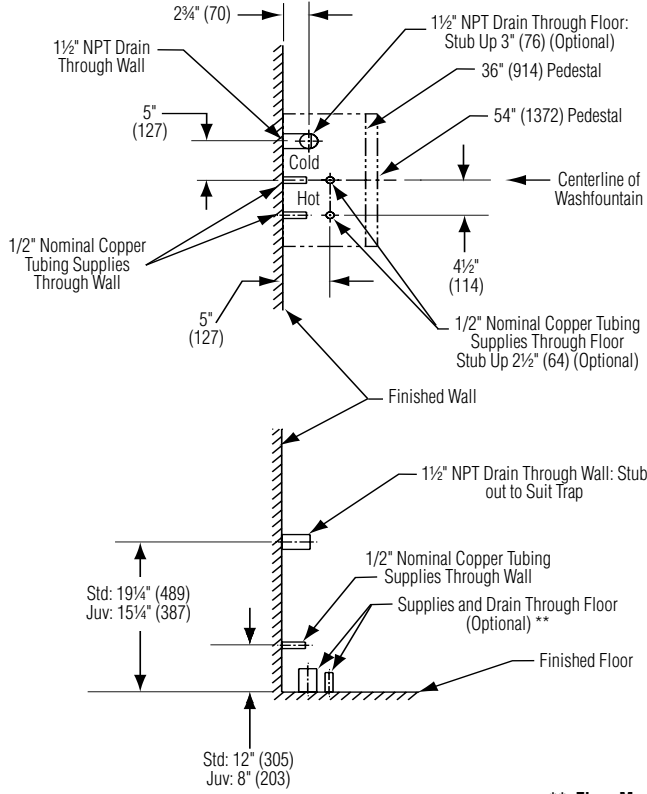

Type B

– Centrally rising vent with supplies from above

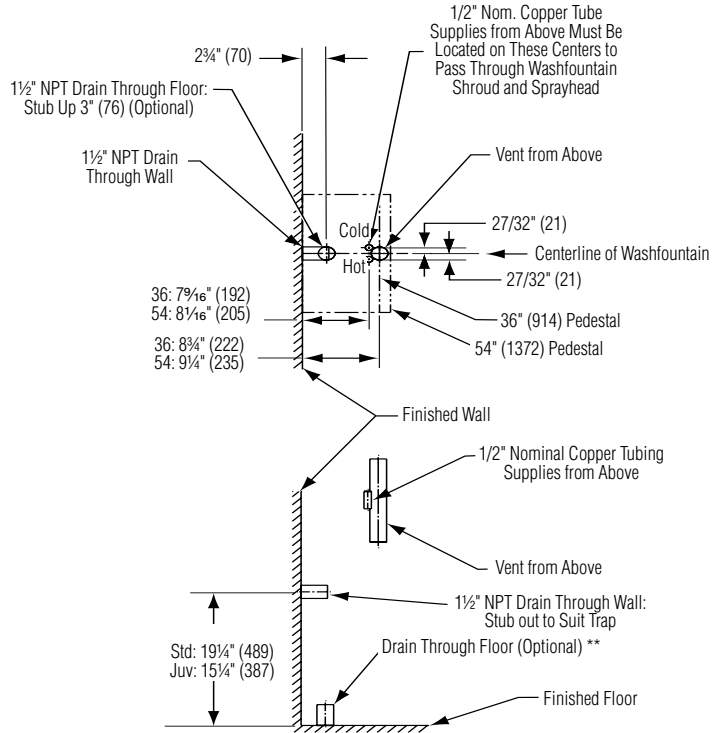

** Floor Mounted Units Only

Type A Drain

- Supplies below
- Off-drain vent
- P-Trap furnished by others

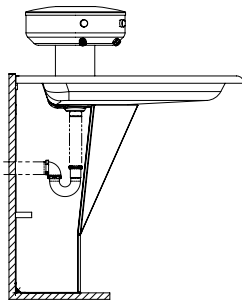

Type B Drain

- Supplies above
- Centrally-rising vent
- P-Trap furnished

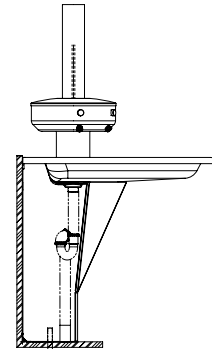

Rough-In Notes

1. Maximum flow rate required to washfountain is 1.5 gpm for Models SN2003 and SN2023 or 2.0 gpm for Model SN2004 and SN2024. Size supply lines accordingly.
2. Unit with "A" drain and paper towel dispensers and/or a shroud should use "H" drain Rough-Ins.



S93-650

Sentry™ Semi-Circular Shallow Bowl Washfountain

Rough-In Dimensions for Drain and Supplies

(mm)

Type H Drain

– Centrally rising vent with supplies from below

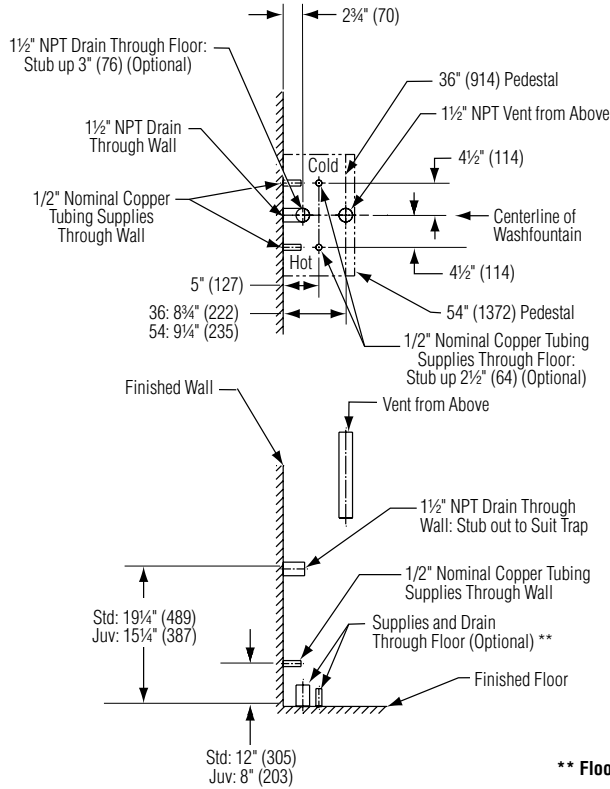

Type O Drain

– Off-line vent with supplies from above

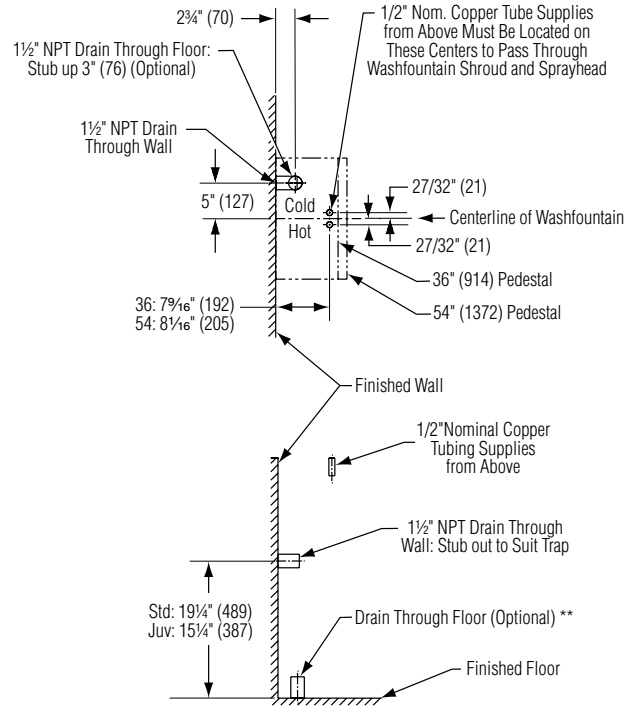

** Floor Mounted Units Only

Type H Drain

- Supplies below
- Centrally-rising vent
- P-Trap furnished

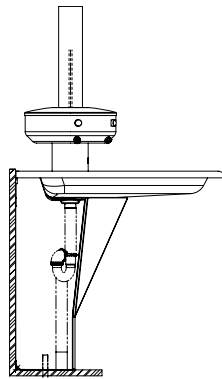

Type O Drain

- Supplies above
- Off-drain vent
- P-Trap furnished by others

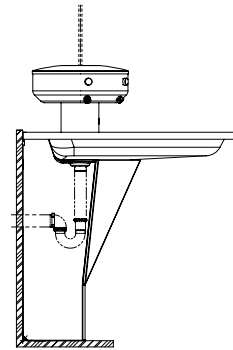

Rough-In Notes

1. Maximum flow rate required to washfountain is 1.5 gpm for Models SN2003 and SN2023 or 2.0 gpm for Model SN2004 and SN2024. Size supply lines accordingly.
2. Unit with "O" drain and paper towel dispensers and/or a shroud should use "B" drain Rough-Ins.