



Instructions for the following series products:
Mobi-Lok Self-contained Vacuum Anchor
(See back page for specific model numbers.)

USER INSTRUCTION MANUAL SELF-CONTAINED VACUUM ANCHOR SYSTEM

This manual is provided as the Manufacturer's Instructions, and should be used as part of an employee training program as required by OSHA.

Figure 1 - Self-Contained Vacuum Anchor System

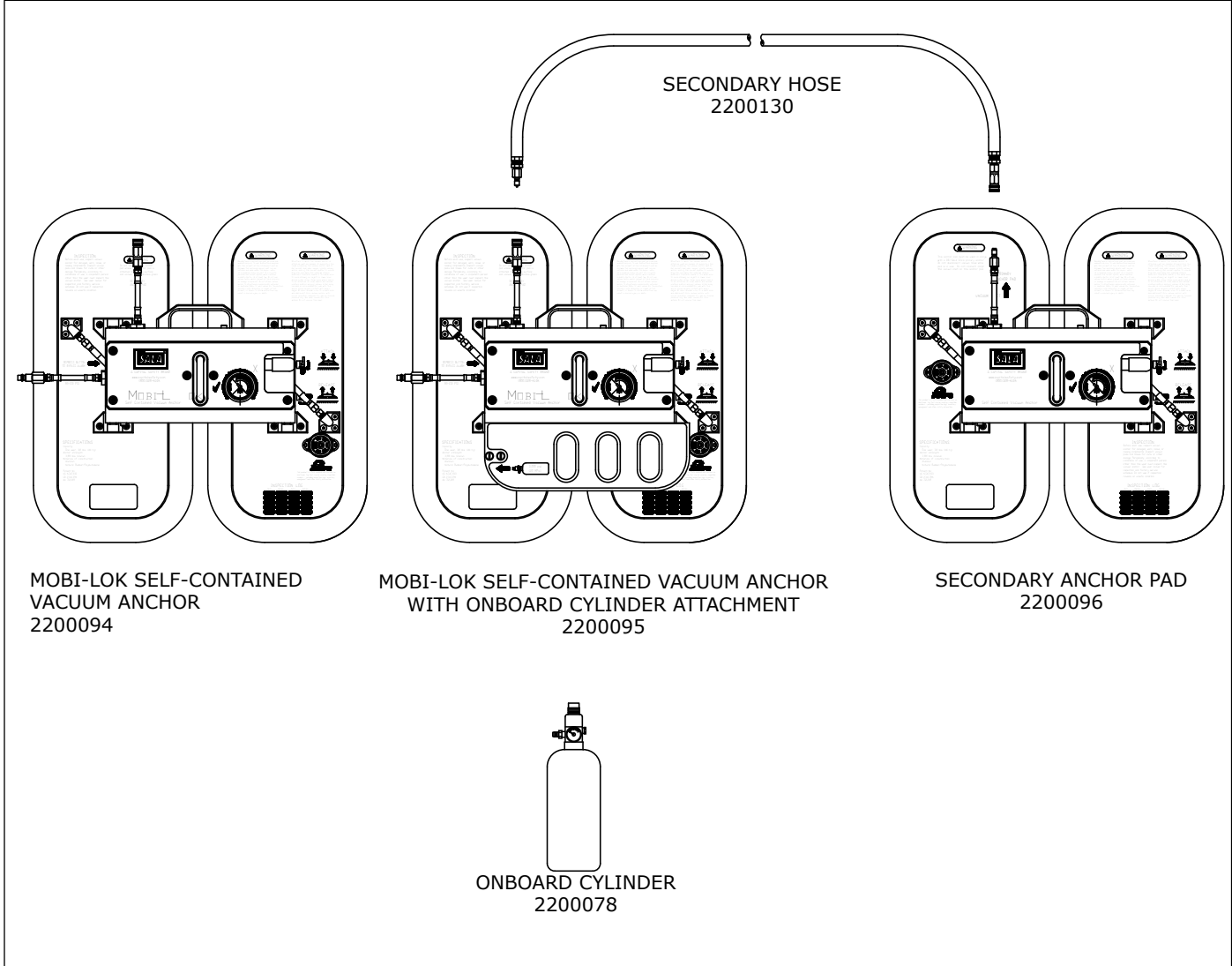

WARNING: *This product is part of a personal restraint, work positioning, suspension, or rescue system. These instructions must be provided to the user and rescuer (see section 8.0 Terminology). The user must read and understand these instructions or have them explained to them before using this equipment. The user must read and follow the manufacturer's instructions for each component or part of the complete system. Manufacturer's instructions must be followed for proper use and maintenance of this product. Alterations or misuse of this product or failure to follow instructions may result in serious injury or death.*

IMPORTANT: *If you have questions on the use, care, or suitability of this equipment for your application, contact DBI-SALA.*

1.0 APPLICATION

1.1 PURPOSE: The Mobi-Lok Self-Contained Vacuum Anchor System is intended to be used as an anchorage connector for connection of a personal fall protection system for personnel working on aircraft or other structures. See Figures 2 and 3 for typical fall arrest and restraint applications.

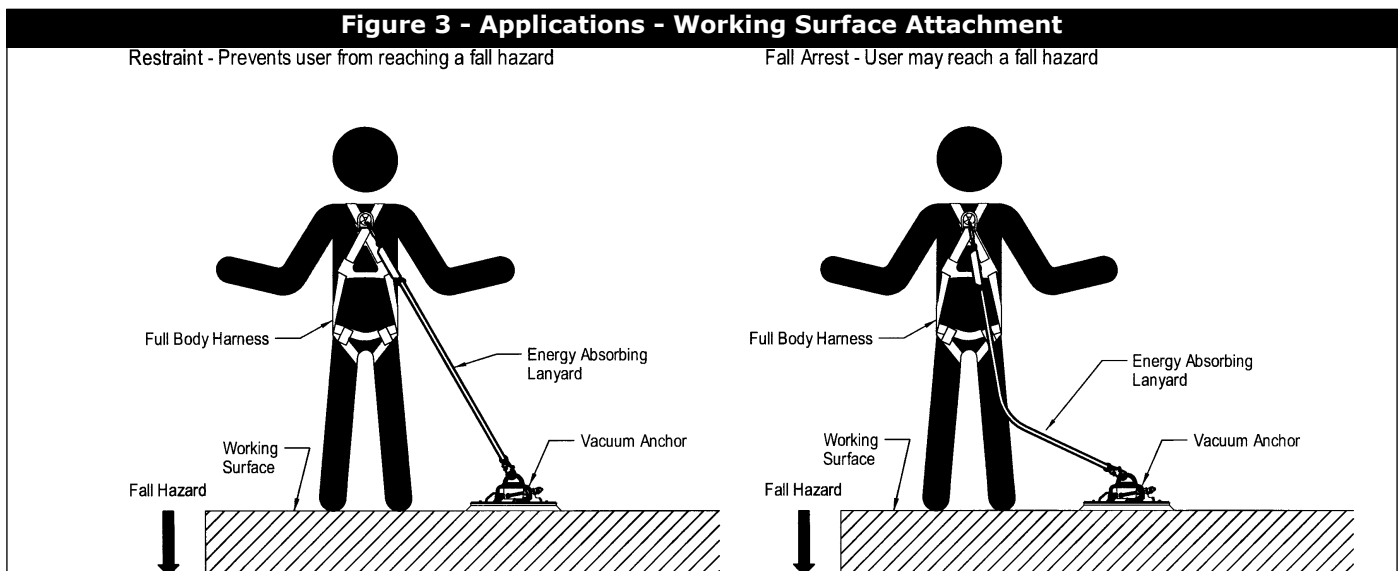
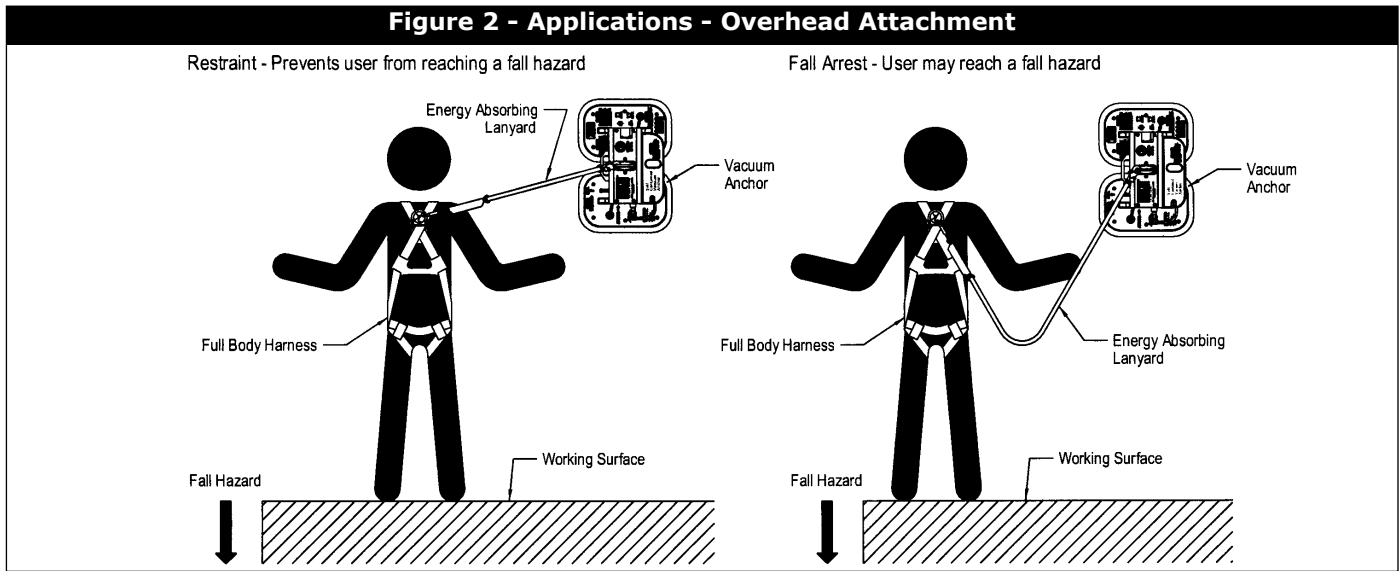

1.2 LIMITATIONS:

- A. ANCHORAGE STRUCTURE:** The surface to which the Mobi-Lok Self-Contained Vacuum Anchor is attached must be selected according to the limitations and strength requirements specified in this manual. See section 2.5 for more information.
- B. PERSONAL FALL ARREST SYSTEM:** Personal fall arrest systems used with the Mobi-Lok Self-Contained Vacuum Anchor System must meet the system requirements specified in section 2.1 of this manual. A DBI-SALA Force2 Energy Absorbing Lanyard must be used with the Mobi-Lok Self-Contained Vacuum Anchor System unless authorized by DBI-SALA (see instruction no. 5908550). Consult DBI-SALA if you desire to use any other type of lanyard connecting subsystem.
- C. CAPACITY:** The Mobi-Lok Self-Contained Vacuum Anchor System is designed for use by persons with a combined weight (clothing, tools, etc.) of no more than 310 lbs (141 kg). Only one personal fall arrest system may be connected to a single Mobi-Lok Self-Contained Vacuum Anchor.

D. FALL CLEARANCE: There must be sufficient clearance below the user to arrest a fall before the user strikes the ground or other obstruction. The clearance required is dependent on the following factors:

- Elevation of Vacuum Anchor
 - Deceleration distance
 - Worker height
 - Connecting subsystem length
 - Movement of harness attachment element
 - Free fall distance
- See each personal fall arrest subsystem manufacturer's instructions for more information.

E. ENVIRONMENTAL HAZARDS: Use of this equipment in hazardous environments may require additional precautions to reduce the possibility of injury to the user or damage to the equipment. Hazards may include, but are not limited to; heat, caustic or corrosive chemicals, high voltage power lines, explosive or toxic gases, moving machinery, and sharp edges.

F. TRAINING: This equipment is intended to be installed and used by persons trained in its application and use.

1.3 APPLICABLE STANDARDS: Refer to national Standards including ANSI Z359 (.0, .1, .2, .3, and .4) family of standards on fall protection, ANSI A10.32, and applicable local, state and federal (OSHA) requirements governing occupational safety for more information on this equipment and associated system components.

2.0 SYSTEM REQUIREMENTS

2.1 PERSONAL FALL ARREST SYSTEM:

A. COMPONENTS AND SUBSYSTEMS: The Mobi-Lok Self-Contained Vacuum Anchor System is designed for use with DBI-SALA approved components and subsystems. Non-approved components or subsystems may be incompatible with the Mobi-Lok Self-Contained Vacuum Anchor System, which could affect the safety and reliability of the complete system. Personal fall arrest systems must meet applicable local, state, and federal (OSHA) requirements. A full body harness must be used with this system.

B. ENERGY ABSORBING LANYARD: A DBI-SALA Force2 Energy Absorbing Lanyard must be used with this system unless authorized by DBI-SALA. To maintain a safety factor of at least 2, the personal fall arrest system must limit fall arrest forces to 1,400 lbs. (6.2 kN) (complies with OSHA arresting force limit of 1,800 lbs. [8.0 kN], for systems incorporating a full body harness). The system should be rigged to limit free fall to 6 ft. (1.8 m) or less. Some applications may require attaching the Mobi-Lok Self-Contained Vacuum Anchor on the working surface at foot level. A free fall greater than 6 ft. (1.8 m) may be possible in this configuration. If the 6 ft. (1.8 m) free fall is exceeded, OSHA requires the employer to document, with test data, that the maximum permissible arresting forces will not be exceeded, and that the personal fall arrest system will function properly. DBI-SALA has verified through testing of the Force2 Energy Absorbing Lanyard in free falls up to 12 ft (3.7 m) that the arresting forces do not exceed 1,400 lbs. (6.2 kN). Test results are specified in the Force2 Energy Absorbing Lanyard User Instruction Manual (no. 5908550). Consult DBI-SALA if you desire to use any other type of lanyard connecting subsystem.

2.2 RESTRAINT SYSTEM: Restraint systems must meet the requirements of personal fall arrest systems as stated in section 2.1.

2.3 COMPRESSED AIR SOURCE: In order to operate, this system requires a constant source of compressed air or nitrogen, delivering 80 – 150 psi (550 - 1035 kPa). This may be a compressor delivering shop air, a compressed air cylinder, or compressed nitrogen cylinder. If you have any questions about the appropriateness of your source of compressed air, contact DBI-SALA.

2.4 COMPATIBILITY OF CONNECTORS: Connectors (hooks, carabiners, D-rings) must be capable of supporting a minimum of 5,000 lbs. (22.2kN). Connectors must be compatible with all attachment points, including the Self-Contained Vacuum Anchor and other system components. Non-compatible connectors may unintentionally disengage (roll-out). Connectors must be compatible in size, shape, and strength. Self locking connectors must be used with this equipment.

2.5 ANCHORAGE STRUCTURE: From OSHA 1910.66 and 1926.500: Anchorages used for attachment of a personal fall arrest system shall be independent of any anchorage being used to support or suspend platforms, and must support at least 5,000 lbs. (22.2 kN) per user attached, or be designed, installed, and used as part of a complete personal fall arrest system which maintains a safety factor of at least two, and is supervised by a qualified person. When more than one Mobi-Lok Self-Contained Vacuum Anchor is installed on the structure, the structure must be capable of supporting the strengths stated above for each Mobi-Lok Self-Contained Vacuum Anchor attached to the structure.

2.6 ATTACHING TO AIRCRAFT:

DO NOT ATTACH THE MOBI-LOK SELF-CONTAINED VACUUM ANCHOR TO:

- Composite elements/Non-metal surfaces (unless authorized by aircraft manufacturer)
- Cabin and cockpit windows
- Passenger/Emergency/Cargo doors
- Maintenance/Access doors
- Areas around cut-outs which are not sufficiently supported by structural elements (stringers and frames)
- Areas outside of wingbox in-spar skin, i.e. "No Step Lines"
- Moveable control surfaces

ACCEPTABLE ATTACHMENTS:

- The system may be used on the fuselage where supported by frames and stringers, and on the wing upper surface between the spars.

If a fall occurs, the area to which the Mobi-Lok Self-Contained Vacuum Anchor was attached must be removed from service and inspected for structural integrity by a competent person.

2.7 ATTACHING TO STRUCTURES:

DO NOT ATTACH THE MOBI-LOK SELF-CONTAINED VACUUM ANCHOR TO:

- Structure where the pad will not seal properly or leakage is apparent
- Structurally inappropriate materials or surfaces.
- Porous or uneven surfaces that will prevent a proper seal.
- Excessively dirty, greasy surfaces that will prevent a proper seal.

3.0 INSTALLATION AND USE

WARNING: Do not alter or intentionally misuse this equipment. Consult with Capital Safety when using this equipment in combination with components or subsystems other than those described in this manual. Some subsystem and component combinations may interfere with the operation of this equipment. Use caution when using this equipment around moving machinery and electrical hazards. Do not loop the lanyard around small structural members.

WARNING: Do not use this system if you are unable to tolerate the impact from a fall arrest. Age and fitness can seriously affect your ability to withstand falls. Pregnant women and minors must not use this equipment.

3.1 BEFORE EACH USE of this equipment inspect it according to section 5.0 of this manual.

3.2 PLAN your personal fall arrest system before installing and using this equipment. Consider all factors affecting your safety during use.

A. SYSTEM LOCATION: Establish the location of the Mobi-Lok Self-Contained Vacuum Anchor System before starting your work. See Figures 2 and 3. If rigging as a restraint system is not possible, position the Mobi-Lok Self-Contained Vacuum Anchor such that the potential free fall is minimized by locating the Mobi-Lok Self-Contained Vacuum Anchor overhead, or limiting the lanyard length and slack. It is recommended that the system is kept as short as possible. Provide safe access to and from the work location.

B. FALL CLEARANCE: See Figure 4. There must be sufficient clearance in your fall path to prevent striking an object or lower level in the event of a fall. The amount of clearance required is dependent on the application. See Force2 Energy Absorbing Lanyard User Instruction Manual for information on calculating fall clearance.

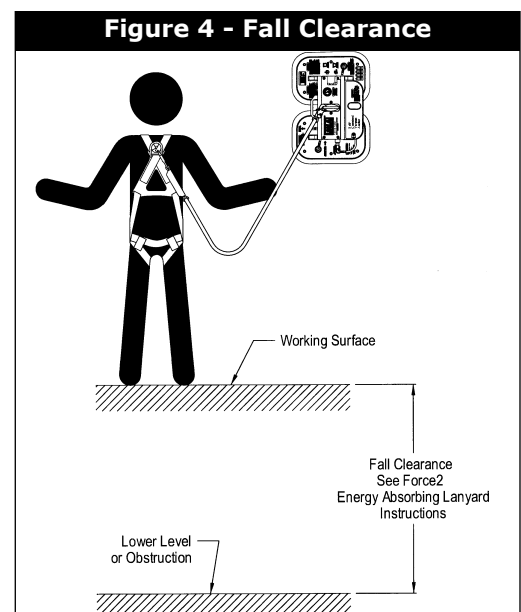

C. SWING FALLS: Swing falls occur when the anchorage point is not directly above or below the point where a fall occurs. See Figure 5. The force of striking an object in a swing fall may cause serious injury or death. Minimize swing falls by working as close to the anchorage point as possible. Do not permit a swing fall if injury could occur.

D. SHARP EDGES: Avoid working where parts of the system will be in contact with, or abrade against, unprotected sharp edges.

E. AFTER A FALL: Components which have been subjected to the forces of arresting a fall must be removed from service and destroyed, or returned to an authorized service center for inspection or repair.

F. RESCUE: The employer must have a rescue plan when using this equipment. The employer must have the ability to perform a rescue quickly and safely.

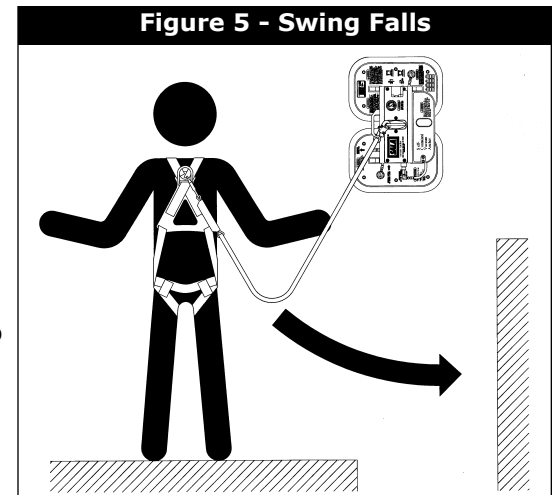

3.3 PREPARING THE MOBI-LOK SELF-CONTAINED VACUUM ANCHOR SYSTEM FOR USE :

Refer to Figure 6 for component identification.

A. Mobi-Lok Self-Contained Vacuum Anchor Primary Pad - external compressed air source (2200094):

Step 1. Before each use inspect the Mobi-Lok Self-Contained Vacuum Anchor System according to section 5.0 of this manual. Inspect all other fall protection components according to their manufacturer's instructions.

Step 2. Compressed air connection:

- Connect the compressed air hose to the compressed air or nitrogen source (80 - 150 psi [550 - 1035 kPa]).
- Connect the other end of the air hose to the compressed air connector on the Mobi-Lok Self-Contained Vacuum Anchor
- Ensure the Attach/Release control valve on the Mobi-Lok Self-Contained Vacuum Anchor is in the "Release" position.

B. Mobi-Lok Self-Contained Vacuum Anchor Primary Pad - with onboard compressed air cylinder (2200095):

Step 1. Before each use inspect the Mobi-Lok Self-Contained Vacuum Anchor System according to section 5.0 of this manual. Inspect all other fall protection components according to their manufacturer's instructions.

Step 2. Compressed air connection:

- Select a compressed air cylinder (2200078) with a minimum pressure of 1,000 psi. Screw the cylinder into the socket underneath the guard on the Vacuum Anchor unit until it is hand tight. If the gauge on the cylinder is in a position that is not readable, unscrew it up to one full turn until the gauge is readable.
- Ensure Attach/Release control valve on Mobi-Lok Self-Contained Vacuum Anchor is in the "Release" position.

C. MOBI-LOK SELF-CONTAINED VACUUM ANCHOR SECONDARY PAD (2200096):

Step 1. Before each use inspect the Mobi-Lok Self-Contained Vacuum Anchor System according to section 5.0 of this manual. Inspect all other fall protection components according to their manufacturer's instructions.

Step 2. Vacuum connection:

- Attach the secondary hose (2200130) to the vacuum connection of the primary pad.
- Attach the other end of the hose to the vacuum connection of the secondary pad
- Ensure the Attach/Release control valve on the secondary pad is in the "Release" position.

Figure 6 - Component Identification - Mobi-Lok Self-Contained Vacuum Anchor

Mobi-Lok Self-contained vacuum pad with external air source (2200094)

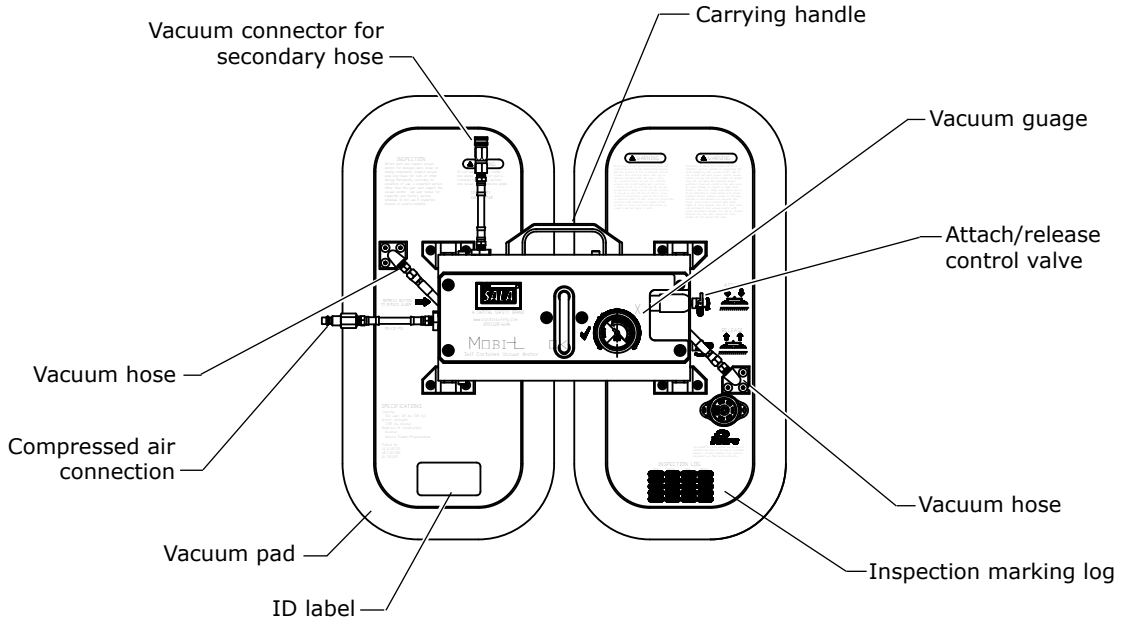

SIDE VIEW OF MOBI-LOK SELF-CONTAINED VACUUM ANCHOR PAD

MOBI-LOK SELF-CONTAINED VACUUM PAD WITH ON BOARD COMPRESSED AIR CYLINDER (2200095)

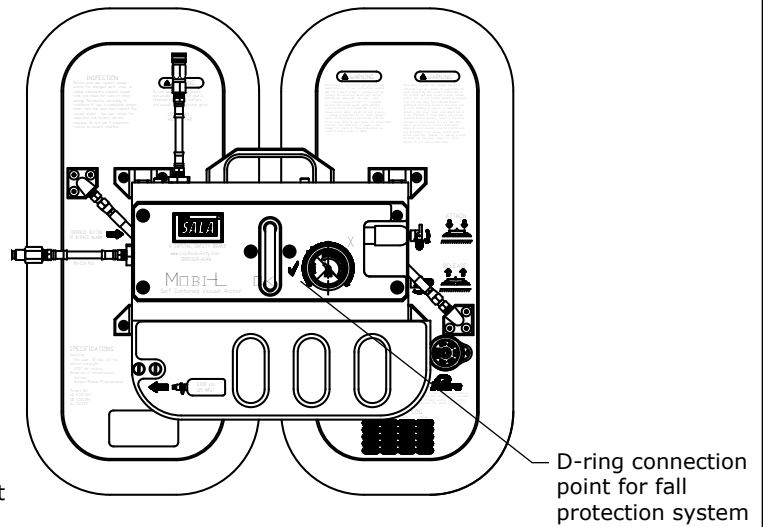
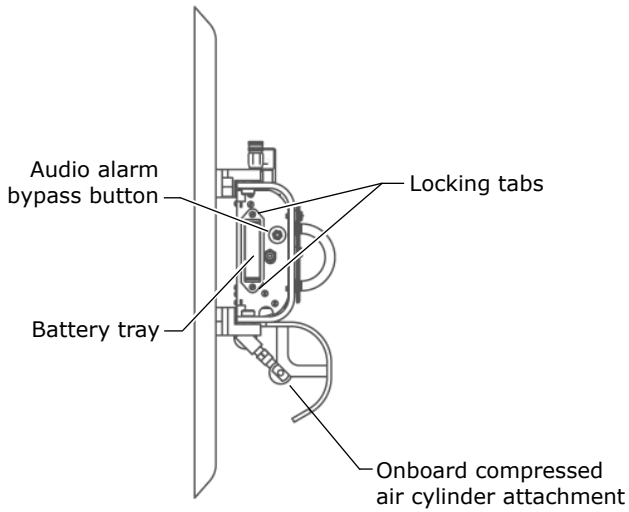

BOTTOM VIEW OF ALL VACUUM ANCHOR PADS

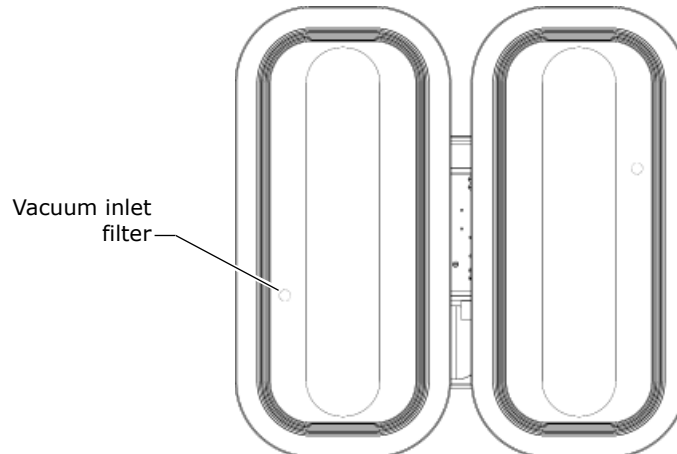
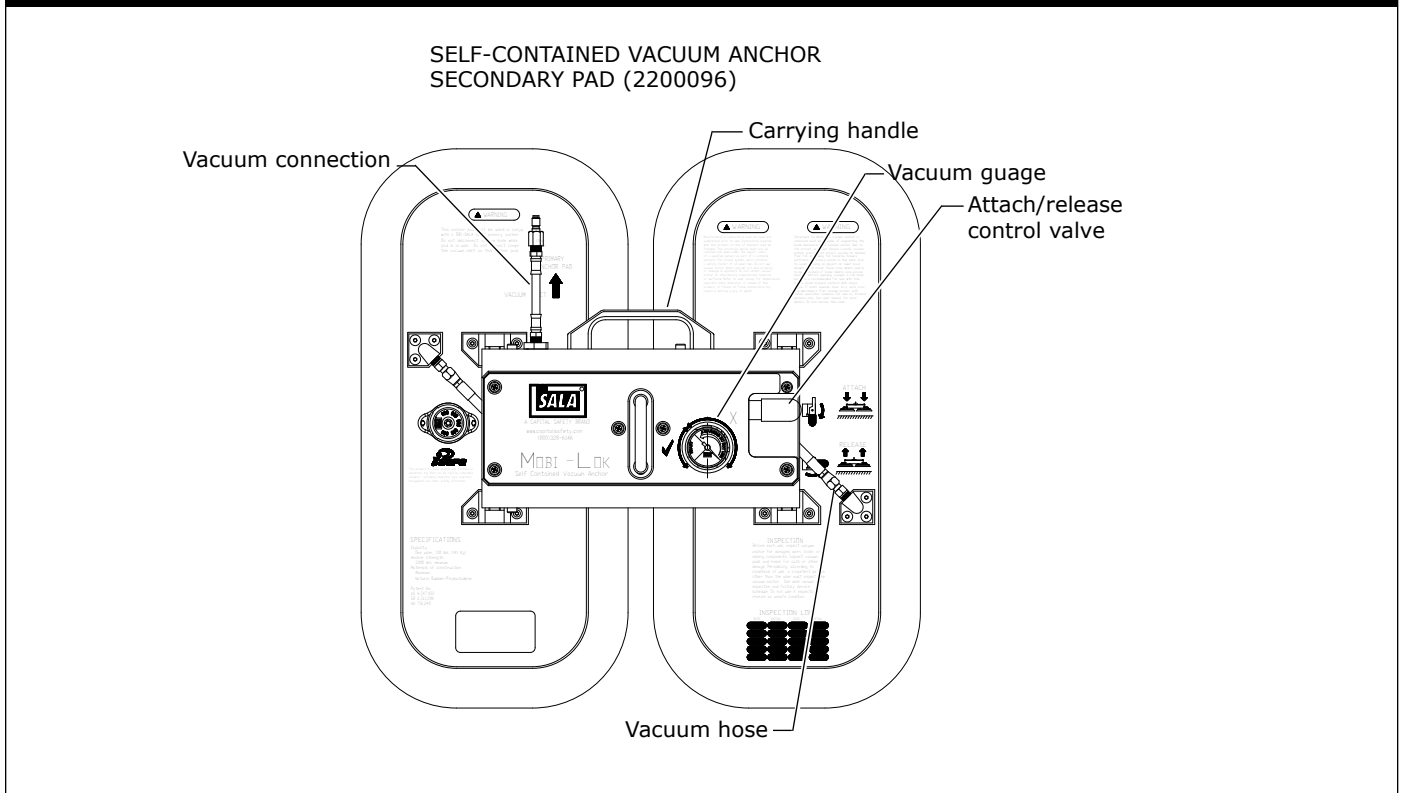

Figure 6 Continued - Component Identification - Mobi-Lok Self-Contained Vacuum Anchor



3.4 USING THE MOBI-LOK SELF-CONTAINED VACUUM ANCHOR SYSTEM:

A. PRIMARY PAD (2200094 AND 2200095):

Step 3. Clean the area where the pads are to be attached to absorb excess moisture and remove loose debris. Excess moisture or debris could be pulled into the system, which may corrode or damage the vacuum pump and other components. Place Mobi-Lok Self-Contained Vacuum Anchor against the surface to which it is to be attached. When using the system on a curved surface, the vacuum pads must be positioned one above the other to conform to the curvature, as shown in Figure 7. Depress the "Alarm Bypass" button and turn the Attach/Release control valve to "Attach" position. If the Alarm Bypass button is not depressed, the audio alarm will sound until the operating vacuum level is reached. A slight downward pressure on the pads may be required to create the initial seal. When the vacuum gauge reaches the green region, release the Alarm Bypass button. The Mobi-Lok Self-Contained Vacuum Anchor System is now ready for attachment of your personal fall arrest system. If the audio alarm sounds during use (other than described above), disconnect your fall protection system from the Mobi-Lok Self-Contained Vacuum Anchor System as soon as safely possible; an insufficient vacuum level is present and the system may not support fall restraint or fall arrest loads.

Step 4. Attach your fall protection system to the D-ring connector on the Mobi-Lok Self-Contained Vacuum Anchor as shown in Figure 7. Ensure roll-out of the attachment

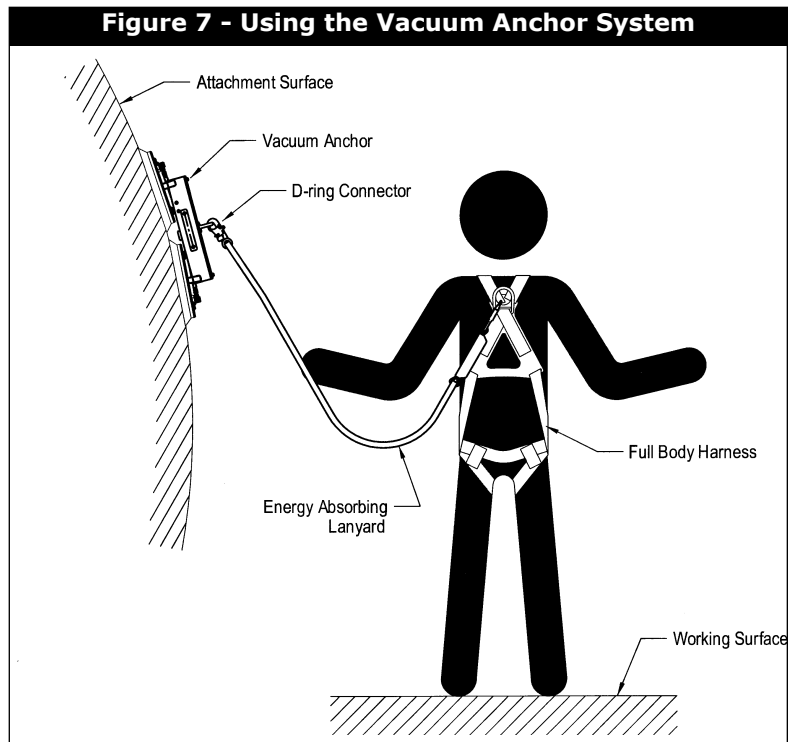

hook or carabiner cannot occur. Roll-out occurs when interference between the hook and mating connector causes the hook gate to unintentionally open and release. Self locking snap hooks and carabiners must be used to reduce the possibility of roll-out. Do not use connectors that will not completely close over the attachment object. Do not connect snap hooks or carabiners to each other. See personal fall arrest system manufacturer's instructions for connecting subsystems used with the Mobi-Lok Self-Contained Vacuum Anchor System.

WARNING: Do not connect any lanyard to the carrying handle of any vacuum anchor pad.

B. SECONDARY ANCHOR PAD (2200096)

- Step 5. Clean area where pads are to be attached to absorb excess moisture and remove loose debris. Excess moisture or debris could be pulled into the system, which may corrode or damage the vacuum pump and other components. Place the secondary pad against surface to which it is to be attached. When using the system on a curved surface, the vacuum pads must be positioned one above the other to conform to the curvature, as shown in Figure 7. Depress the "Alarm Bypass" button on the Primary pad if possible, and turn the Attach/Release control valve to "Attach" position. If the Alarm Bypass button is not depressed, the audio alarm will sound until the operating vacuum level is reached. A slight downward pressure on the pads may be required to create the initial seal. When the vacuum gauge reaches the green region, release the Alarm Bypass button. The Secondary Pad Anchor is now ready for attachment of your personal fall arrest system. If the audio alarm sounds during use (other than described above), disconnect your fall protection system from the Mobi-Lok Self-Contained Vacuum Anchor System as soon as safely possible; an insufficient vacuum level is present and the system may not support fall restraint or fall arrest loads.

WARNING: Do not use the secondary pad if the primary pad is not attached to a surface.

3.5 REPOSITIONING THE MOBI-LOK SELF-CONTAINED VACUUM ANCHOR SYSTEM:

- Step 6. To reposition Mobi-Lok Self-Contained Vacuum Anchor, turn the Attach/Release control valve to the "Release" position. Move the Mobi-Lok Self-Contained Vacuum Anchor to a new location, depress the Alarm Bypass button and turn Attach/Release control valve to "Attach" position. Wait for the gauge to move into the green area before releasing the Alarm Bypass button and attaching your lanyard to the pad. Note: If the Alarm Bypass button is not depressed, the audio alarm will sound until the operating vacuum level is reached.

WARNING: Do not reposition the primary pad while the secondary pad is in use.

3.6 USING MOBI-LOK SELF-CONTAINED VACUUM ANCHOR AS A HORIZONTAL LIFELINE ANCHORAGE:

See instruction 5902166 for the use of the Mobi-Lok Self-Contained Vacuum anchor as anchor points for the Vacuum Anchor Horizontal Lifeline System.

3.7 REPLACING THE BATTERY

- Depress the locking tabs on the sides of the battery tray and slide the tray out from the side of the Self-Contained Vacuum Anchor.
- Remove and discard the old batteries
- Install the new batteries (DBI-SALA part no 9501987) into the battery tray, being careful to orient the batteries as shown in the bottom of the tray.
- Slide the tray back into the side of the Mobi-Lok Self-Contained Vacuum Anchor until the tabs catch and lock.

4.0 TRAINING

- 4.1 The user and purchaser of this equipment must be familiar with the instructions, operating characteristics, application limits, and the consequences of improper use of this equipment. Users and purchasers must be trained in the correct care and use of this equipment.

WARNING: Training must be conducted without exposing the trainee to a fall hazard. Training should be repeated on a periodic basis.

5.0 INSPECTION AND MAINTENANCE

- 5.1 **MOBI-LOK SELF-CONTAINED VACUUM ANCHOR INSPECTION PROCEDURES:** See Figure 6 for part identifications and locations.

BEFORE EACH USE:

- Inspect the Mobi-Lok Self-Contained Vacuum Anchor System for damage and loose or missing parts.
- Inspect the rubber vacuum pads for wear or damage. Inspect the underside of the vacuum pads. Wipe off any debris collected on the inlet filter.
- Test the battery: Ensure the audio alarm operates when the "Attach/Release" control valve is moved to the "Attach" position (without depressing the Alarm Bypass button). If the audio alarm fails to operate, the batteries may require replacement. See section 3.7 for instructions on changing the batteries.
- Do not use the Mobi-Lok Self-Contained Vacuum Anchor System if any part fails inspection.

MONTHLY:

Monthly inspections may be replaced by performing the following inspection of the Mobi-Lok Self-Contained Vacuum Anchor System before or after each use.

- Inspect all electrical connectors and visible wiring for cuts, wear, and heat or chemical damage.
- Inspect the vacuum inlet hoses for cuts, wear, crushing, and heat or chemical damage.
- All labels must be present and fully legible.
- Inspect the rubber vacuum pads for cuts, burns, weather checking, and torn or damaged sealing lips.
- Check for loose or missing fasteners.
- Ensure the audio alarm is working properly:
 - Step 1.** Connect a compressed air source (air compressor or onboard cylinder) to the primary pad.
 - Step 2.** Place the Mobi-Lok Self-Contained Vacuum anchor onto a smooth, clean, dry surface (such as the floor or a bench top).
 - Step 3.** Turn the "Attach/Release" control valve to the "Attach" position. The audio alarm should sound until the "operating vacuum" level is reached.
 - Step 4.** Disconnect the compressed air supply. The alarm should sound. If the audible intensity level is not normal, the battery may require replacing. See Section 3.7. After replacing the battery, check the alarm function again. If the system still fails, contact Capital Safety for authorized service.
- Do not use the Mobi-Lok Self-Contained Vacuum Anchor System if any part fails inspection.

ANNUALLY:

- Annually, the Mobi-Lok Self-Contained Vacuum Anchor pad assembly must be inspected by a Capital Safety authorized service technician.

6.0 SPECIFICATIONS

6.1 SYSTEM WEIGHTS:

- Primary Pad: 18 lbs. (8.2 kg)
- Primary Pad with onboard cylinder attachment: 20 lbs. (9.1 kg)
- Primary Pad with onboard cylinder attachment and full cylinder: 23 lbs. (10.4 kg)
- Secondary pad: 15 lbs. (6.8 kg)

6.2 ELECTRICAL SPECIFICATIONS:

- Four 'AA' lithium batteries (6.0 V).

6.3 COMPRESSED AIR SPECIFICATIONS:

- Mobi-Lok Self-Contained Vacuum Anchor system requires 80 – 150 psi (550 - 1035 kPa)

6.4 MINIMUM APPLICATION RADIUS: 30 in. (76 cm)

6.5 MOBI-LOK SELF-CONTAINED VACUUM ANCHOR STATIC CAPACITY: Approximately 3,375 lbs. (15 kN) on unpainted surface.

6.6 MOBI-LOK SELF-CONTAINED VACUUM ANCHOR OPERATING RANGES:

- Maximum altitude: Contact DBI-SALA for usages over 5,000 ft. (1500 m) above sea level.
- Temperatures:

AIR: -20°F to 115°F (-29°C to 46°C)

SURFACE: -20° F to 140°F (-29°C to 60°C)

6.7 PAD SIZE:

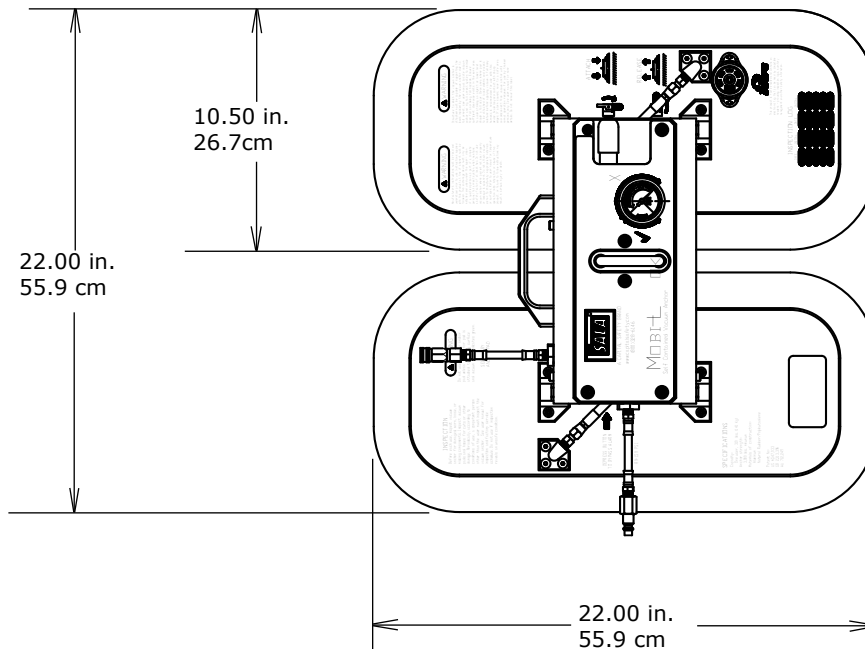

7.0 LABELING

7.1 MOBI-LOK SELF-CONTAINED VACUUM ANCHOR (2200094) LABELS

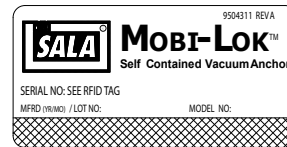
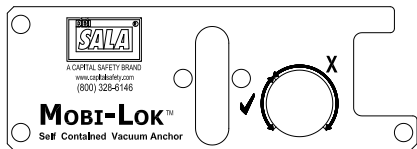
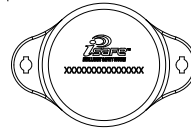
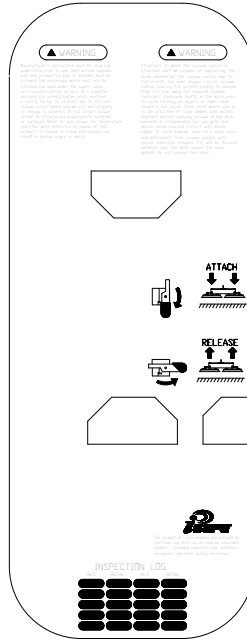
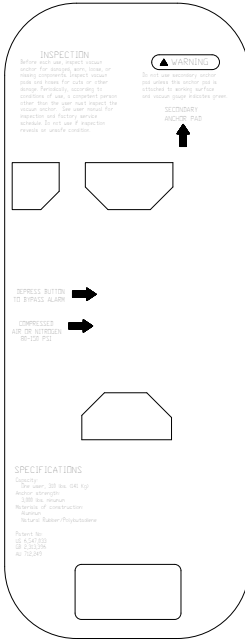

7.2 MOBI-LOK SELF-CONTAINED VACUUM ANCHOR WITH ONBOARD CYLINDER ATTACHMENT (200095) LABELS

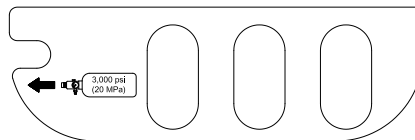
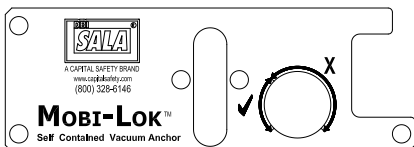
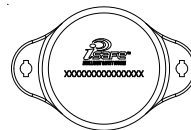
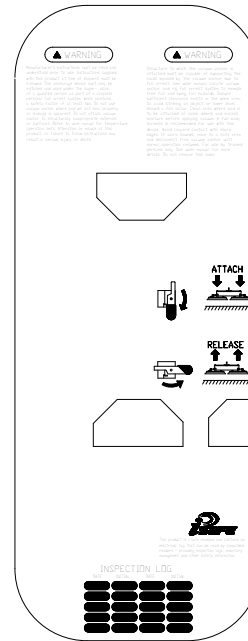
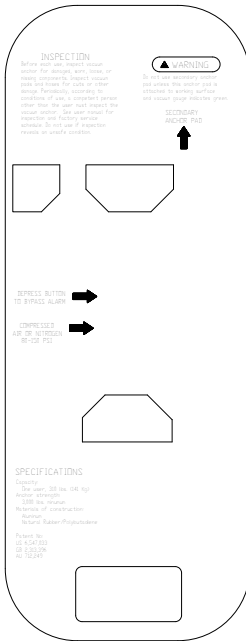

7.3 SECONDARY ANCHOR PAD (2200096) LABELS

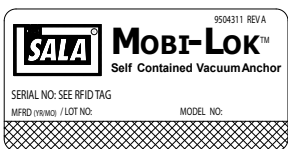
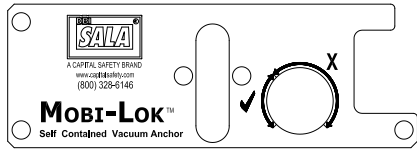
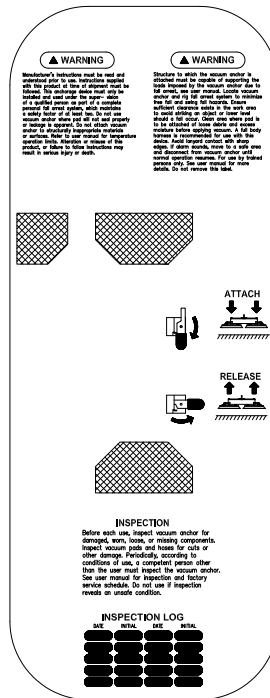
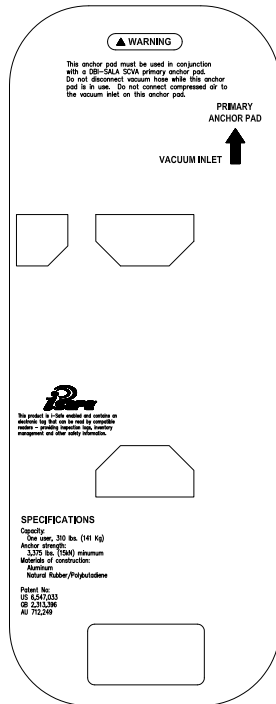

8.0 TERMINOLOGY

AUTHORIZED PERSON: A person assigned by the employer to perform duties at a location where the person will be exposed to a fall hazard (otherwise referred to as "user" for the purpose of these instructions).

RESCUER: Person or persons other than the rescue subject acting to perform an assisted rescue by operation of a rescue system.

CERTIFIED ANCHORAGE: An anchorage for fall arrest, positioning, restraint, or rescue systems that a qualified person certifies to be capable of supporting the potential fall forces that could be encountered during a fall or that meet the criteria for a certified anchorage prescribed in this standard.

QUALIFIED PERSON: A person with a recognized degree or professional certificate and with extensive knowledge, training, and experience in the fall protection and rescue field who is capable of designing, analyzing, evaluating and specifying fall protection and rescue systems to the extent required by this standard.

COMPETENT PERSON: One who is capable of identifying existing and predictable hazards in the surroundings or working conditions which are unsanitary, hazardous, or dangerous to employees, and who has authorization to take prompt corrective measures to eliminate them.

This instruction applies to the following Models:

2200094

2200095

2200096

2200121

2200124

Additional Model Numbers may appear on the next printing of these instructions.

LIMITED LIFETIME WARRANTY

Warranty to End User: D B Industries, Inc., dba CAPITAL SAFETY USA ("CAPITAL SAFETY") warrants to the original end user ("End User") that its products are free from defects in materials and workmanship under normal use and service. This warranty extends for the lifetime of the product from the date the product is purchased by the End User, in new and unused condition, from a CAPITAL SAFETY authorized distributor. CAPITAL SAFETY'S entire liability to End User and End User's exclusive remedy under this warranty is limited to the repair or replacement in kind of any defective product within its lifetime (as CAPITAL SAFETY in its sole discretion determines and deems appropriate). No oral or written information or advice given by CAPITAL SAFETY, its distributors, directors, officers, agents or employees shall create any different or additional warranties or in any way increase the scope of this warranty. CAPITAL SAFETY will not accept liability for defects that are the result of product abuse, misuse, alteration or modification, or for defects that are due to a failure to install, maintain, or use the product in accordance with the manufacturer's instructions.

CAPITAL SAFETY'S WARRANTY APPLIES ONLY TO THE END USER. THIS WARRANTY IS THE ONLY WARRANTY APPLICABLE TO OUR PRODUCTS AND IS IN LIEU OF ALL OTHER WARRANTIES AND LIABILITIES, EXPRESSED OR IMPLIED. CAPITAL SAFETY EXPRESSLY EXCLUDES AND DISCLAIMS ANY IMPLIED WARRANTIES OF MERCHANTABILITY OR FITNESS FOR A PARTICULAR PURPOSE, AND SHALL NOT BE LIABLE FOR INCIDENTAL, PUNITIVE OR CONSEQUENTIAL DAMAGES OF ANY NATURE, INCLUDING WITHOUT LIMITATION, LOST PROFITS, REVENUES, OR PRODUCTIVITY, OR FOR BODILY INJURY OR DEATH OR LOSS OR DAMAGE TO PROPERTY, UNDER ANY THEORY OF LIABILITY, INCLUDING WITHOUT LIMITATION, CONTRACT, WARRANTY, STRICT LIABILITY, TORT (INCLUDING NEGLIGENCE) OR OTHER LEGAL OR EQUITABLE THEORY.



A Capital Safety Company

CSG USA & Latin America

3833 SALA Way
Red Wing, MN 55066-5005
Toll Free: 800.328.6146
Phone: 651.388.8282
Fax: 651.388.5065
solutions@capitalsafety.com

CSG Canada

260 Export Boulevard
Mississauga, ON L5S 1Y9
Phone: 905.795.9333
Toll-Free: 800.387.7484
Fax: 888.387.7484
info.ca@capitalsafety.com

CSG Northern Europe

Unit 7 Christleton Court
Manor Park
Runcorn
Cheshire, WA7 1ST
Phone: + 44 (0)1928 571324
Fax: + 44 (0)1928 571325
csgne@capitalsafety.com

CSG EMEA (Europe, Middle East, Africa)

Le Broc Center
Z.I. 1ère Avenue
5600 M B.P. 15 06511
Carros
Le Broc Cedex
France
Phone: + 33 4 97 10 00 10
Fax: + 33 4 93 08 79 70
information@capitalsafety.com

CSG Australia & New Zealand

95 Derby Street
Silverwater
Sydney NSW 2128
AUSTRALIA
Phone: +(61) 2 8753 7600
Toll-Free : 1 800 245 002 (AUS)
Toll-Free : 0800 212 505 (NZ)
Fax: +(61) 2 87853 7603
sales@capitalsafety.com.au

CSG Asia

Singapore:
16S, Enterprise Road
Singapore 627666
Phone: +65 - 65587758
Fax: +65 - 65587058
inquiry@capitalsafety.com

Shanghai:

Rm 1406, China Venturetech Plaza
819 Nan Jing Xi Rd,
Shanghai 200041, P R China
Phone: +86 21 62539050
Fax: +86 21 62539060

www.capitalsafety.com



Certificate No. FM 39709