

Kellems® Wire Management Products
 PolyTuff® Non-Metallic Liquidtight Fittings
 Liquidtight Fitting

HUBBELL

Features

- Nylon compression nut has a tapered dome to tighten ferrule onto conduit
- Neoprene O-ring provides liquidtight seal
- Non integral ferrule provides conduit seal and pullout protection

Ordering Information

Description	Device Color	Trade Size	UPC	Catalog Number
Fixed 90° Fittings for Non-Metallic Conduit	Black	1/2" (16)	783585810003	P0509NBK

Listings

UL Listed
 CSA Certified

Specifications

Fitting	Nylon
Sealing Ring	Elastomer
Lockwasher	Zinc plated steel

Performance

Environmental	
Flammability	UL 94V-2
Operating Temperature	-30°F to +225°F (-34°C to +107°C)

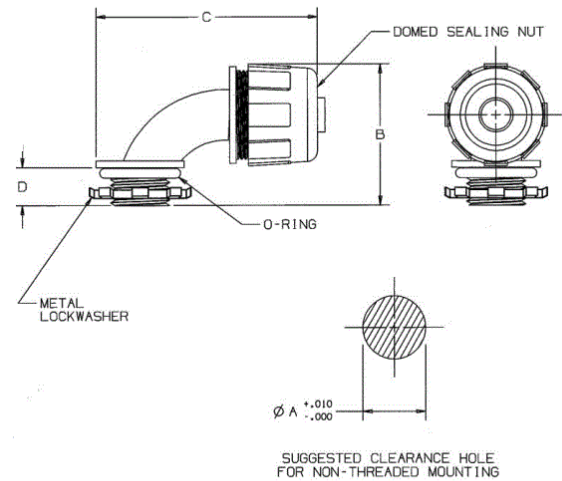

Online Resources

Customer Use Drawing
 eCatalog

Dimensions in Inches (mm)

Hubbell Wiring Device-Kellems • Hubbell Incorporated (Delaware) • 40 Waterview Drive • Shelton, CT 06484

Phone (800) 288-6000 • Fax (800) 255-1031 • Specifications subject to change without notice.

