

Kellems® Wire Management Products  
 PolyTuff® Non-Metallic Liquidtight Fittings  
 Liquidtight Fitting

# HUBBELL

## Features

- Nylon compression nut has a tapered dome to tighten ferrule onto conduit
- Neoprene O-ring provides liquidtight seal
- Non integral ferrule provides conduit seal and pullout protection

## Ordering Information

Description	Device Color	Trade Size	UPC	Catalog Number
Fixed 90° Fittings for Non-Metallic Conduit	Gray	3/8" (12)	783585334158	P0389NGY

## Listings

UL Listed  
 CSA Certified

## Specifications

Fitting	Nylon
Sealing Ring	Elastomer
Lockwasher	Zinc plated steel

## Performance

Environmental	
Flammability	UL 94V-2
Operating Temperature	-30°F to +225°F (-34°C to +107°C)

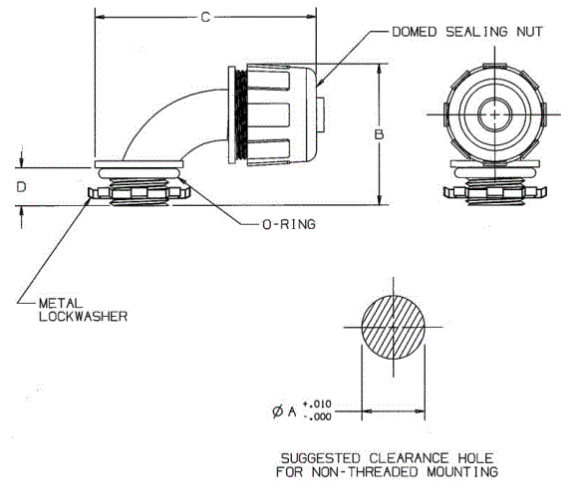

## Online Resources

Customer Use Drawing  
 eCatalog

Dimensions in Inches (mm)

Hubbell Wiring Device-Kellems • Hubbell Incorporated (Delaware) • 40 Waterview Drive • Shelton, CT 06484

Phone (800) 288-6000 • Fax (800) 255-1031 • Specifications subject to change without notice.

