



INSTALLATION DATA

5500 SERIES

INFINITE SWITCH UNI-KIT®

The Robertshaw® 5500 Infinite Switch Uni-Kit® is designed to provide universal heat replacement of original equipment infinite switches and 3, 5 and 7 switches.

The dial adaptors allow the serviceman to use the customer's dial on the replacement switch. The dial shaft may be broken off to the required length and is factory assembled in the switch.

The standard and commercial models differ only in that the commercial model has a heavy duty dial shaft (requiring different dial shaft adaptors).

ELECTRICAL RATING

15 Amp at 120/240V AC resistive load.

INSTALLATION INSTRUCTIONS



CAUTION

THIS DEVICE SHOULD BE INSTALLED BY A QUALIFIED SERVICE TECHNICIAN WITH DUE REGARD FOR SAFETY, AS IMPROPER INSTALLATION COULD RESULT IN A HAZARDOUS CONDITION.

Disconnect all power to equipment before servicing

MOUNTING

1. Determine mounting type, palnut (figure 1) or screw (figure 2), and mount control accordingly. If temperature indicator plate is used refer to figure 3 (standard models only). **NOTE:** Word "TOP" on rear of control must be installed UP for proper calibration.
2. Assemble kit dial per instructions below. Place it or original dial on dial shaft using adaptors as needed. Standard models are supplied with numerous plastic adaptors (see figure 4 for assembly of clip spring adaptor). Commercial models are supplied with metal clip springs (see figure 5).
3. Measure distance from back of dial to panel front. Remove control and measure off same distance on shaft from end towards control body. Find breakoff groove nearest this distance and mark.
4. Place a pair of pliers on each side of the marked groove. Hold pliers firmly and break shaft. **DO NOT HOLD SWITCH BODY.**
5. Remount control; then proceed to wiring instructions on back page.

SLIP-FIT® DIAL ASSEMBLY

NOTE: IT IS ESSENTIAL TO READ EACH STEP COMPLETELY BEFORE PERFORMING THE DIRECTIONS GIVEN IN THAT STEP.

1. Turn control to the "Off" position.
2. Locate the 4-way insert included with this dial kit. See figure 1. One side has "RCC UNI-LINE" molded in the plastic. Push the 4-way insert flush onto the tip of the dial shaft of the control with "RCC UNI-LINE" facing away from the control. See figure 2.
3. Referring to the other control knobs on the appliance, determine which way the "blade figure 1, on the new knob is to be oriented in the "Off" position; vertical or horizontal.
4. Using the vertical or horizontal orientation desired, partially assemble the knob onto the insert to obtain proper alignment. See figure 3. Then remove the knob with the insert attached,

STANDARD MODEL

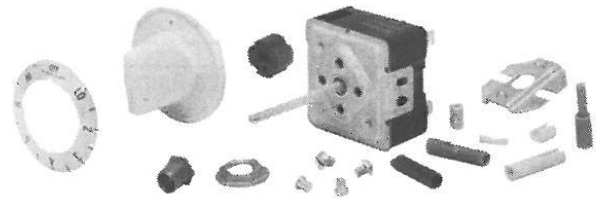

COMMERCIAL MODEL

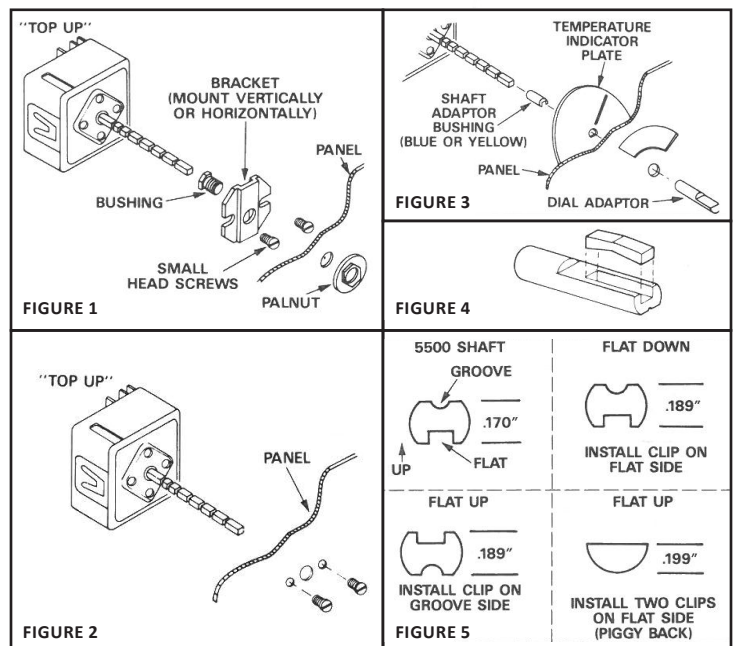
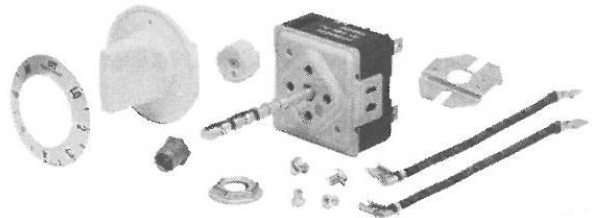

and press the insert all the way into the knob. When completely in place approximately 1/8" of the 4-way insert will be outside of the knob. Reinstall knob.

5. Take the Slip-Fit overlay, figure 1, and carefully remove the clear protective covering over the numbered side. Begin removal from the inside edge of the overlay. See figure 4.
6. Carefully peel off the backing from the adhesive that is on the back of the Slip-Fit overlay. Try not to touch the adhesive. See figure 5
7. Position the Slip-Fit dial overlay over the knob with the "Off" position aligned in the desired position. Carefully slide the Slip-Fit overlay down and over the locating ribs on the knob. See figure 6.
8. Press the Slip-Fit overlay firmly into position. Use a soft cloth and rub around the overlay to obtain a permanent fit. See figure 7

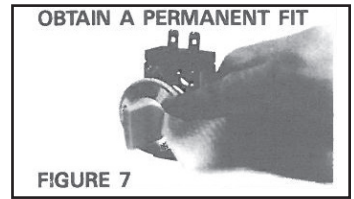
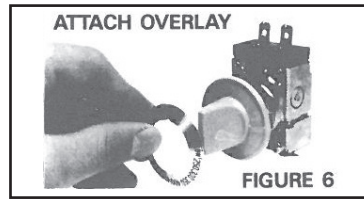
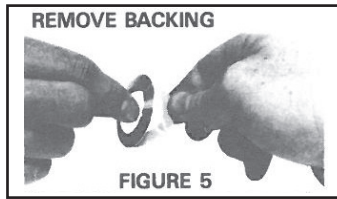
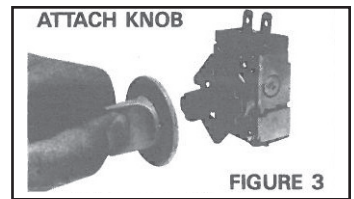
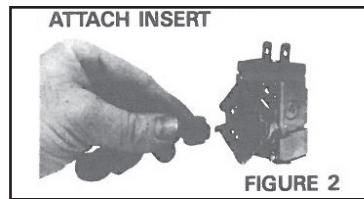
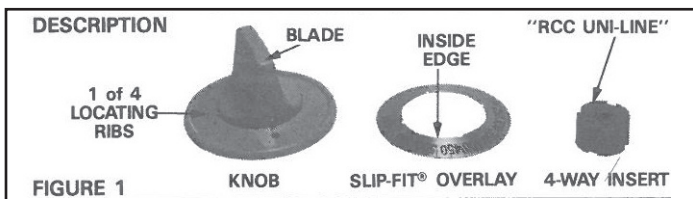

WIRING

See appropriate wiring diagram. **WHEN INSTALLING ON RANGE WITH OTHER TOP ELEMENT SWITCHES DO THIS:**

1. Disconnect power to range.
2. Connect the line wires to L1 and L2 terminals.
3. Connect the two load wires to H1 and H2 terminals.
4. Do not connect pilot lamp wire at this time.
5. Reconnect power to stove. Turn on the new switch and one of the other switches.
6. Place volt meter leads on L1 of the new switch and the P terminal of other switch mentioned in step 5. If you read 220 volts, you must reverse the wires at L1 and L2 of the new switch before installing the pilot wire to the P terminal of the new switch.

SPECIAL NOTE: "FLASHER" UNITS (Standard Models Only)

On dual voltage or "flasher" type switches a 120 volt single coil element was used in which the "flasher" switch provided 240 volts for about 20 seconds and then operated as an infinite control at 120 volts. When replacing this type flasher switch, replace with the 120V AC type infinite control. The surface element need not be replaced. Westinghouse also used another type flasher during 1952 to 1954. They used a double coil element which consisted of two 625 watt 118 volt coils. During the flash period the two element coils were placed in parallel across 240 volts and the switch after flashing connected the two coils in series across 240 volts. Use a 240VAC type infinite replacement and make sure the two 625 watt elements are connected in series.

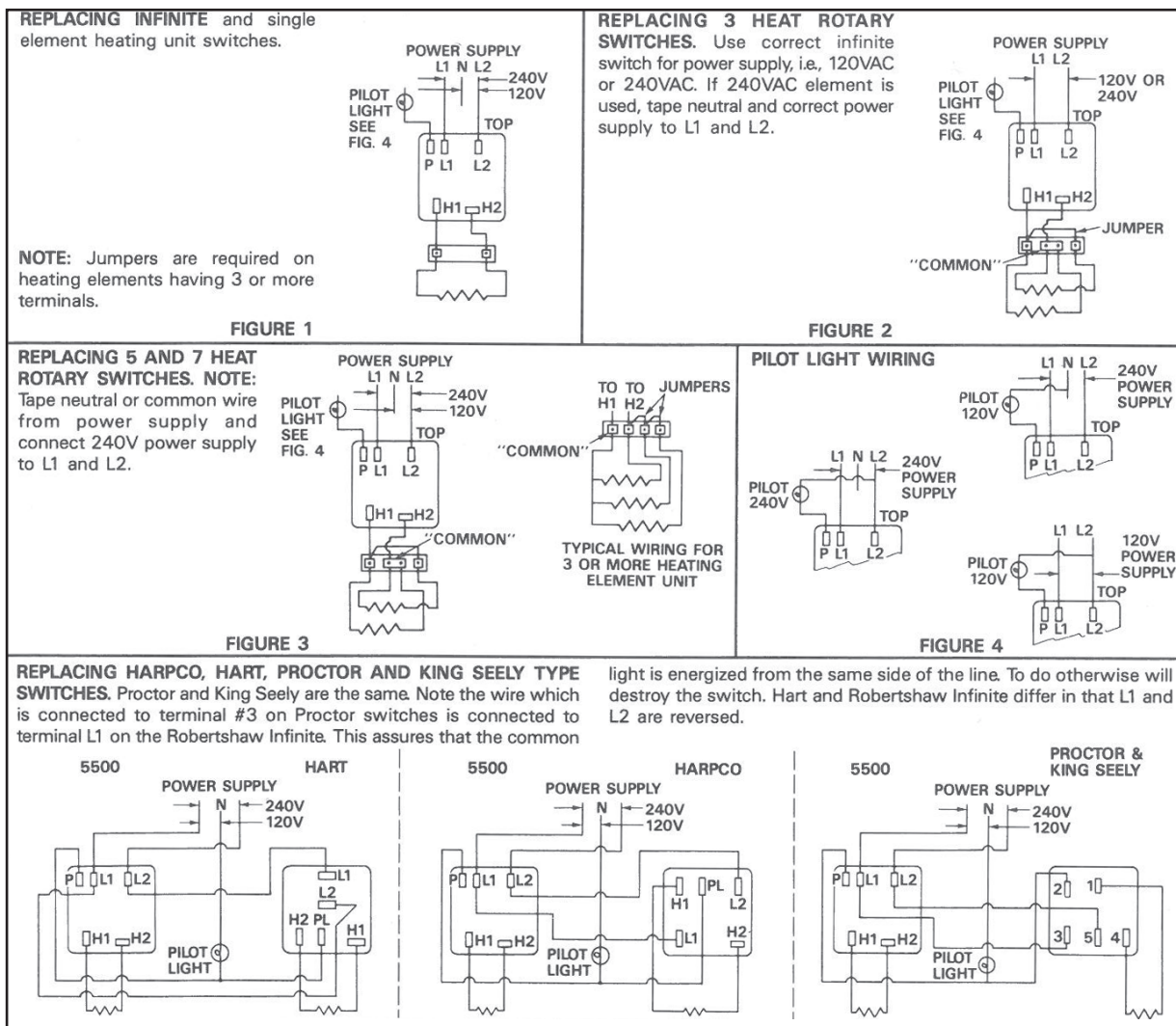

Customer Service Telephone 1.800.304.6563
Customer Service Facsimile 1.800.426.0804
HVACCustomerService@robertshaw.com

For Technical Service
Telephone 1.800.445.8299
Facsimile 1.630.260.7294
TechnicalService@robertshaw.com

Robertshaw®, Ranco®, Paragon® and Uni-Line® are trademarks of Robertshaw, its subsidiaries and/or affiliated companies. All other brands mentioned may be the trademarks of their respective owners.

www.uni-line.com
www.robertshaw.com
©2014 Robertshaw
09/14 -1-456 RevC