



INCANDESCENT COPPER-FREE ALUMINUM FIXTURES



Enclosed & Gasketed

UL LISTED - File E27731

SP Certified - File LR11851

INTRODUCTION AND ORDERING INFORMATION

V Series

Enclosed & Gasketed

Applications

- Locations requiring durable, protected lighting fixtures
- Wet and dirt laden locations
- Industrial environments requiring enclosed and gasketed (vapor tight) fixtures
- Fixtures intended for base-up mounting
- Heat resistant glass globes recommended for wet locations

Features

- Electrostatically applied epoxy/polyester finish
- Modular design
- Hubs are threaded for attachment to conduit
- Set screws in pendant fixture
- Copper-free aluminum (less than .004%)



PENDANT MOUNT WITH VGA SPLICE BOX/DANT								
FIXTURE TYPE	LAMP WATT	HUB SIZE	CATALOG NUMBER		CONSISTS OF			
			FIXTURE W/ GLOBE	FIXTURE W/ GLOBE & GUARD	MOUNTING BOX	FIXTURE BODY	CLEAR GLOBE*	GUARD (if selected)
100	150	1/2"	VUAG-1-100Ⓢ	VUAGG-1-100Ⓢ	VGA-1	VFC-100	VCG-100	VAG-100
		3/4"	VUAG-2-100Ⓢ	VUAGG-2-100Ⓢ	VGA-2	VFC-100	VCG-100	VAG-100
200	300	1/2"	VUAG-1-200Ⓢ	VUAGG-1-200Ⓢ	VGA-1	VFC-200	VCG-200	VAG-200
		3/4"	VUAG-2-200Ⓢ	VUAGG-2-200Ⓢ	VGA-2	VFC-200	VCG-200	VAG-200

CEILING MOUNT WITH FEET USING VBC SPLICE BOX AND VBA ADAPTER								
FIXTURE TYPE	LAMP WATT	HUB SIZE	CATALOG NUMBER		CONSISTS OF			
			FIXTURE W/ GLOBE	FIXTURE W/ GLOBE & GUARD	MOUNTING BOX/ ADAPTER	FIXTURE BODY	CLEAR GLOBE*	GUARD (if selected)
100	150	1/2"	VUXG-1-100Ⓢ	VUXGG-1-100Ⓢ	VBC-1 + VBA	VFC-100	VCG-100	VAG-100
		3/4"	VUXG-2-100Ⓢ	VUXGG-2-100Ⓢ	VBC-2 + VBA	VFC-100	VCG-100	VAG-100
200	300	1/2"	VUXG-1-200Ⓢ	VUXGG-1-200Ⓢ	VBC-1 + VBA	VFC-200	VCG-200	VAG-200
		3/4"	VUXG-2-200Ⓢ	VUXGG-2-200Ⓢ	VBC-2 + VBA	VFC-200	VCG-200	VAG-200

CEILING MOUNT WITH VGX SPLICE BOX								
FIXTURE TYPE	LAMP WATT	HUB SIZE	CATALOG NUMBER		CONSISTS OF			
			FIXTURE W/ GLOBE	FIXTURE W/ GLOBE & GUARD	MOUNTING BOX	FIXTURE BODY	CLEAR GLOBE*	GUARD (if selected)
100	150	1/2"	VUXG-1-100Ⓢ	VUXGG-1-100Ⓢ	VGX-1	VFC-100	VCG-100	VAG-100
		3/4"	VUXG-2-100Ⓢ	VUXGG-2-100Ⓢ	VGX-2	VFC-100	VCG-100	VAG-100
200	300	1/2"	VUXG-1-200Ⓢ	VUXGG-1-200Ⓢ	VGX-1	VFC-200	VCG-200	VAG-200
		3/4"	VUXG-2-200Ⓢ	VUXGG-2-200Ⓢ	VGX-2	VFC-200	VCG-200	VAG-200

CEILING MOUNT WITH VGC SPLICE BOX - FEED THROUGH								
FIXTURE TYPE	LAMP WATT	HUB SIZE	CATALOG NUMBER		CONSISTS OF			
			FIXTURE W/ GLOBE	FIXTURE W/ GLOBE & GUARD	MOUNTING BOX	FIXTURE BODY	CLEAR GLOBE*	GUARD (if selected)
100	150	1/2"	VUXG-1-100Ⓢ	VUXGG-1-100Ⓢ	VGC-1	VFC-100	VCG-100	VAG-100
		3/4"	VUXG-2-100Ⓢ	VUXGG-2-100Ⓢ	VGC-2	VFC-100	VCG-100	VAG-100
200	300	1/2"	VUXG-1-200Ⓢ	VUXGG-1-200Ⓢ	VGC-1	VFC-200	VCG-200	VAG-200
		3/4"	VUXG-2-200Ⓢ	VUXGG-2-200Ⓢ	VGC-2	VFC-200	VCG-200	VAG-200

* For other colors, order globes and fixture components separately.

Ⓢ Fixture supplied as component unit pack when ordered by this catalog number.

Ⓢ Catalog number for ordering convenience; fixture is shipped as components as listed in catalog number table.

LIGHTING

V SERIES • WEATHERPROOF



INCANDESCENT COPPER-FREE ALUMINUM FIXTURES



ORDERING INFORMATION



CEILING MOUNT WITH VGH SPLICE BOX - DEAD END								
FITTURE TYPE	LAMP WATT	HUB SIZE	CATALOG NUMBER		CONSISTS OF			
			FIXTURE W/ GLOBE	FIXTURE W/ GLOBE & GUARD	MOUNTING BOX	FIXTURE BODY	CLEAR GLOBE*	GUARD (if selected)
100	150	1/2"	VUHG-1-100Ⓣ	VUHGG-1-100Ⓣ	VGH-1	VFC-100	VCG-100	VAG-100
		3/4"	VUHG-2-100Ⓣ	VUHGG-2-100Ⓣ	VGH-2	VFC-100	VCG-100	VAG-100
200	300	1/2"	VUHG-1-200Ⓣ	VUHGG-1-200Ⓣ	VGH-1	VFC-200	VCG-200	VAG-200
		3/4"	VUHG-2-200Ⓣ	VUHGG-2-200Ⓣ	VGH-2	VFC-200	VCG-200	VAG-200



CEILING MOUNT WITH VXA DEEP 5 - HUB SPLICE BOX								
FITTURE TYPE	LAMP WATT	HUB SIZE	CATALOG NUMBER		CONSISTS OF			
			FIXTURE W/ GLOBE	FIXTURE W/ GLOBE & GUARD	MOUNTING BOX	FIXTURE BODY	CLEAR GLOBE*	GUARD (if selected)
100	150	1/2"	VXAG-110Ⓣ	VXAGG-110Ⓣ	VXA-1	VFC-100	VCG-100	VAG-100
		3/4"	VXAG-210Ⓣ	VXAGG-210Ⓣ	VXA-2	VFC-100	VCG-100	VAG-100
200	300	1/2"	VXAG-120Ⓣ	VXAGG-120Ⓣ	VXA-1	VFC-200	VCG-200	VAG-200
		3/4"	VXAG-220Ⓣ	VXAGG-220Ⓣ	VXA-2	VFC-200	VCG-200	VAG-200



CEILING MOUNT WITH VBA ADAPTER FOR ROUND OUTLET BOX								
FITTURE TYPE	LAMP WATT	HUB SIZE	CATALOG NUMBER		CONSISTS OF			
			FIXTURE W/ GLOBE	FIXTURE W/ GLOBE & GUARD	BOX ADAPTER	FIXTURE BODY	CLEAR GLOBE*	GUARD (if selected)
100	150	1/2"	VOB-100Ⓣ	VOBG-100Ⓣ	VBA	VFC-100	VCG-100	VAG-100
200	300	3/4"	VOB-200Ⓣ	VOBG-200Ⓣ	VBA	VFC-200	VCG-200	VAG-200



CEILING MOUNT WITH VFPS ADAPTER FOR SQUARE OR OCTAGON OUTLET BOX								
FITTURE TYPE	LAMP WATT	HUB SIZE	CATALOG NUMBER		CONSISTS OF			
			FIXTURE W/ GLOBE	FIXTURE W/ GLOBE & GUARD	BOX ADAPTER	FIXTURE BODY	CLEAR GLOBE*	GUARD (if selected)
100	150	1/2"	VFCA-100Ⓣ	VFCA-100Ⓣ	VFPS	VFC-100	VCG-100	VAG-100
200	300	3/4"	VFCA-200Ⓣ	VFCA-200Ⓣ	VFPS	VFC-200	VCG-200	VAG-200

NOTES: Mounts directly to steel 4" square and 3-1/2" or 4" octagon outlet box. Supplied with gasket.

* For other colors, order globe and fixture components separately.

Ⓣ Fixture supplied as component unit pack when ordered by this catalog number.

Ⓣ Catalog number for ordering convenience; fixture is shipped as components as listed in catalog number table.



INCANDESCENT COPPER-FREE ALUMINUM FIXTURES



ORDERING INFORMATION



WALL MOUNT WITH FEET USING VBC SPLICE BOX AND VB ELBOW								
FIXTURE TYPE	LAMP WATT	HUB SIZE	CATALOG NUMBER		CONSISTS OF			
			FIXTURE W/ GLOBE	FIXTURE W/ GLOBE & GUARD	MOUNTING BOX/ELBOW	FIXTURE BODY	CLEAR GLOBE*	GUARD (if selected)
100	150	1/2"	VFBG-1-100Ⓞ	VFBGG-1-100Ⓞ	VBC-1+VB-1	VFC-100	VCG-100	VAG-100
		3/4"	VFBG-2-100Ⓞ	VFBGG-2-100Ⓞ	VBC-2+VB-2	VFC-100	VCG-100	VAG-100
200	300	1/2"	VFBG-1-200Ⓞ	VFBGG-1-200Ⓞ	VBC-1+VB-1	VFC-200	VCG-200	VAG-200
		3/4"	VFBG-2-200Ⓞ	VFBGG-2-200Ⓞ	VBC-2+VB-2	VFC-200	VCG-200	VAG-200



WALL MOUNT WITH VB ELBOW TO MOUNT TO 4" OUTLET BOX								
FIXTURE TYPE	LAMP WATT	HUB SIZE	CATALOG NUMBER		CONSISTS OF			
			FIXTURE W/ GLOBE	FIXTURE W/ GLOBE & GUARD	MOUNTING ELBOW	FIXTURE BODY	CLEAR GLOBE*	GUARD (if selected)
100	150	1/2"	VFBG-110Ⓞ	VFBGG-110Ⓞ	VB-1	VFC-100	VCG-100	VAG-100
		3/4"	VFBG-210Ⓞ	VFBGG-210Ⓞ	VB-2	VFC-100	VCG-100	VAG-100
200	300	1/2"	VFBG-120Ⓞ	VFBGG-120Ⓞ	VB-1	VFC-200	VCG-200	VAG-200
		3/4"	VFBG-220Ⓞ	VFBGG-220Ⓞ	VB-2	VFC-200	VCG-200	VAG-200

Mounts directly to VJ or VB Series or 4" steel outlet boxes. One hub in back, supplied with gasket.



WALL MOUNT-WITH VFL ELBOW FOR DIRECT MOUNT TO V SERIES SPLICE BOXES								
FIXTURE TYPE	LAMP WATT	HUB SIZE	CATALOG NUMBER		CONSISTS OF			
			FIXTURE W/ GLOBE	FIXTURE W/ GLOBE & GUARD	MOUNTING ELBOW	FIXTURE BODY	CLEAR GLOBE**	GUARD (if selected)
100	150	-	VOBL-100Ⓞ	VOBLG-100Ⓞ	VFL	VFC-100	VCG-100	VAG-100
200	300	-	VOBL-200Ⓞ	VOBLG-200Ⓞ	VFL	VFC-200	VCG-200	VAG-200



STANCHION MOUNT FOR 1 - 1/4" THREADED PIPE								
FIXTURE TYPE	LAMP WATT	HUB SIZE	CATALOG NUMBER		CONSISTS OF			
			FIXTURE W/ GLOBE	FIXTURE W/ GLOBE & GUARD	MOUNTING ELBOW	FIXTURE BODY	CLEAR GLOBE*	GUARD (if selected)
100	150	1-1/4"	VD-410GⓄ	VD-410GGⓄ	VD-4	VFC-100	VCG-100	VAG-100
200	300	1-1/4"	VD-420GⓄ	VD-420GGⓄ	VD-4	VFC-200	VCG-200	VAG-200

*For other colors, order globe and fixture components separately.

Ⓞ Fixture supplied as component unit pack when ordered by this catalog number.

Ⓞ Catalog number for ordering convenience; fixture is shipped as components as listed in catalog number table.

LIGHTING

V SERIES



INCANDESCENT NEMA 4 - CLASS I, DIV. 2 ALUMINUM FIXTURES

Class I, Div. 2, Groups A,B,C,D
Class I, Zone 2, Groups IIC,IIB,IIA
NEMA 3, 4*

UL LISTED - File E10514
 UL-1571 Standard for incandescent fixtures
 UL-844 Standard for hazardous location fixtures
SP Certified - File LR11713



Pendant

FEATURES-SPECIFICATIONS

Applications

Killark "V" Series Vaportight fixtures are now available Third Party Certified for use in certain hazardous as well as wet locations which require durable, protected lighting fixtures.

Wet and dirt laden industrial environments such as walkways, tunnels, loading docks, stairwells, etc. made hazardous by the presence of flammable vapors as defined by the NEC.

Fixtures intended for base-up mounting only.

Heat resistant (tempered) glass globes recommended for wet locations*.

* Wet location when used with tempered glass.

Features

Killark Vaportight assemblies using VXFC bodies & tempered glass have all the features & advantages of "V" Enclosed & Gasketed" models plus:

- Heavy-duty silicone gasketing for NEMA 4 requirements
- Third party tested & labeled for use in C1D2 areas
- Modular design permits selection of splice box, fixture body, globe, guard and reflector for specific or custom applications
- Existing V Series mounting boxes may be retrofitted to upgrade to NEMA 4; C1D2 suitability
- Copper-free aluminum construction with electrostatically applied epoxy/polyester finish resists corrosion



Ceiling

APPLICATION DATA ①			
FIXTURE TYPE	LAMP SIZE	GLOBE TYPE	TEMPERATURE CODE @ 40°C
100	A-19 60W	colored & clear	T2C (230°C)
100	A-19 70W	colored & clear	T2D (215°C)
100	A-19 100W	colored & clear	T2A (280°C)
100	A-21 100W	colored & clear	T2B (260°C)
100	A-21 150W	colored & clear	T2 (300°C)
200	A-23 150W	colored & clear	T2A (280°C)
200	PS-25 150W	colored & clear	T2B (260°C)
200	A-23 200W	colored & clear	T2 (300°C)
200	PS-25 200W	colored & clear	T2A (280°C)
200	PS-25 300W	colored & clear	(350°C)

① Suitability based on base up installation



INCANDESCENT NEMA 4 - CLASS I, DIV. 2 ALUMINUM FIXTURES



FEATURES-SPECIFICATIONS



PENDANT MOUNT WITH VGA SPlice BOX							
FITTURE TYPE	LAMP WATT	HUB SIZE	CATALOG NUMBER	CONSISTS OF			
			FITTURE W/ GLOBE & GUARD	MOUNTING BOX	FITTURE BODY	CLEAR GLOBE*	GUARD
100	150	1/2"	VUAGG-1-100PX ①	VGA-1	VXFC-100 N34	VCGP-100	VAG-100
		3/4"	VUAGG-2-100PX ①	VGA-2	VXFC-100 N34	VCGP-100	VAG-100
200	300	1/2"	VUAGG-1-200PX ①	VGA-1	VXFC-200 N34	VCGP-200	VAG-200
		3/4"	VUAGG-2-200PX ①	VGA-2	VXFC-200 N34	VCGP-200	VAG-200

CEILING FIXTURE WITH VGX SPlice BOX							
FITTURE TYPE	LAMP WATT	HUB SIZE	CATALOG NUMBER	CONSISTS OF			
			FITTURE W/ GLOBE & GUARD	MOUNTING BOX	FITTURE BODY	CLEAR GLOBE*	GUARD
100	150	1/2"	VUXGG-1-100PX ①	VGX-1	VXFC-100 N34	VCGP-100	VAG-100
		3/4"	VUXGG-2-100PX ①	VGX-2	VXFC-100 N34	VCGP-100	VAG-100
200	300	1/2"	VUXGG-1-200PX ②	VGX-1	VXFC-200 N34	VCGP-200	VAG-200
		3/4"	VUXGG-2-200PX ②	VGX-2	VXFC-200 N34	VCGP-200	VAG-200

CEILING FIXTURE WITH MOUNTING FEET USING VBC SPlice BOX & VBA ADAPTER							
FITTURE TYPE	LAMP WATT	HUB SIZE	CATALOG NUMBER	CONSISTS OF			
			FITTURE W/ GLOBE & GUARD	MOUNTING BOX/ ADAPTER	FITTURE BODY	CLEAR GLOBE*	GUARD
100	150	1/2"	VUXBGG-1-100PX ①	VBC-1+VBA	VXFC-100 N34	VCGP-100	VAG-100
		3/4"	VUXBGG-2-100PX ①	VBC-2+VBA	VXFC-100 N34	VCGP-100	VAG-100
200	300	1/2"	VUXBGG-1-200PX ①	VBC-1+VBA	VXFC-200 N34	VCGP-200	VAG-200
		3/4"	VUXBGG-2-200PX ①	VBC-2+VBA	VXFC-200 N34	VCGP-200	VAG-200

STANCHION MOUNT FOR 1 - 1/4" THREADED PIPE							
FITTURE TYPE	LAMP WATT	HUB SIZE	CATALOG NUMBER	CONSISTS OF			
			FITTURE W/ GLOBE & GUARD	MOUNTING BOX/ ADAPTER	FITTURE BODY	CLEAR GLOBE*	GUARD
100	150	1-1/4"	VD-410GGPX ①	VD-4	VXFC-100 N34	VCGP-100	VAG-100
200	300	1-1/4"	VD-420GGPX ①	VD-4	VXFC-200 N34	VCGP-200	VAG-200

WALL FIXTURE WITH MOUNTING FEET USING VBC SPlice BOX & VB ELBOW							
FITTURE TYPE	LAMP WATT	HUB SIZE	CATALOG NUMBER	CONSISTS OF			
			FITTURE W/ GLOBE & GUARD	MOUNTING BOX/ELBOW	FITTURE BODY	CLEAR GLOBE*	GUARD
100	150	1/2"	VFBGG-1-100PX ①	VBC-1 + VB-1	VXFC-100 N34	VCGP-100	VAG-100
		3/4"	VFBGG-2-100PX ①	VBC-2 + VB-2	VXFC-100 N34	VCGP-100	VAG-100
200	300	1/2"	VFBGG-1-200PX ①	VBC-1 + VB-1	VXFC-200 N34	VCGP-200	VAG-200
		3/4"	VFBGG-2-200PX ①	VBC-2 + VB-2	VXFC-200 N34	VCGP-200	VAG-200

* For other colors, order globes and mounting components separately.

① Fixture supplied as component unit pack when ordered by this catalog number.

② NEMA 3, 4 when used with tempered glass.

LIGHTING

V SERIES



COMPONENT PARTS/ACCESSORIES • INCANDESCENT FIXTURES

VFC Fixture Bodies

Fixture bodies contain lamp receptacle and are threaded to accept globes, guards and reflectors. These fixture bodies are designed for metallic boxes and mount directly to V Series splice boxes. They may also be mounted to VJ Series, VB Series or other 4" outlet boxes with the use of the appropriate adapter plate. Each fixture body is supplied with gaskets.



VFC-100
VXFC-100 N34 ①



VFC-200
VXFC-200 N34 ①

V FIXTURE BODIES	
CATALOG NUMBER	DESCRIPTION
VFC-100	150W max. Enclosed & Gasketed Fixture Body
VFC-200	300W max. Enclosed & Gasketed Fixture Body
VXFC-100 N34	150W max. NEMA 3,4 - Class I, Div. 2 Fixture Body ①
VXFC-200 N34	300W max. NEMA 3,4 - Class I, Div. 2 Fixture Body ①

① Use VXFC body with tempered globe for NEMA 3, 4 - Class I, Div. 2 applications. VXFC body is Class I, Div. 2 only (not N3, N4) when used with standard globes. Consult temperature table for suitability.

V Splice Boxes

For use with types 100 and 200 fixture bodies



VGA



VGH



VGC



VGX



VXA



VBC



VBA



VFPS



VB



VFL



VD

V SPLICE BOXES			DESCRIPTION
CATALOG NUMBER	HUB SIZE & QTY.		
VGA-1	1/2" 1	Pendant mount	
VGA-2	3/4" 1		
VGH-1	1/2" 1	Ceiling mount	
VGH-2	3/4" 1		
VGC-1	1/2" 2	Ceiling mount	
VGC-2	3/4" 2		
VGX-1	1/2" 4	Ceiling mount	
VGX-2	3/4" 4		
VXA-1	1/2" 5	Ceiling mount, deep box	
VXA-2	3/4" 5		
VBC-1*	1/2" 4	Ceiling mount, with 3 close-up plugs (requires VBA Adapter)	
VBC-2*	3/4" 4		
VXAB	- -	Blank close-up plate (less gasket)	

* Volume cu. in. is 18.

V ADAPTER MOUNTING PLATES	
CATALOG NUMBER	DESCRIPTION
VBA	Adapts fixture body to VB, VJ or steel 3-1/2" & 4" splice boxes. Supplied with gasket.
VFPS	Adapts fixture body to steel 4" square outlet boxes or 3-1/2" or 4" octagon boxes

V MOUNTING BRACKETS			
CATALOG NUMBER	HUB SIZE	QTY.	DESCRIPTION
VB-1	1/2"	1	Wall mount to VJ or VB boxes
VB-2	3/4"	1	Wall mount to VJ or VB boxes
VFL	—	—	Wall mount to V boxes directly or to VJ, VB boxes with VBA adapter
VD-4	1-1/4"	1	Stanchion mount



COMPONENT PARTS/ACCESSORIES • INCANDESCENT FIXTURES



150 W Max.
Lamp Size A-21



300 W Max.
Lamp Size PS-25



Polycarbonate



Poly Color Globe

V GLASS GLOBES		
CATALOG NUMBER		DESCRIPTION
150 W A-21 LAMP	300 W PS-25 LAMP	
VCG-100	VCG-200	Clear
VCGP-100	VCGP-200	Clear Tempered. Thermal and shock resistant ①
VCGPT-100	—	Clear Tempered with silicone coating ②
VAMG-100	VAMG-200	Amber
VAMGP-100	—	Amber Tempered ①
VGG-100	VGG-200	Blue Green
VGGP-100	VGGP-200	Blue Green Tempered ①
VBG-100	—	Blue
VBGp-100	—	Blue Tempered ①
VRG-100	VRG-200	Ruby
VRGP-100	VRGP-200	Ruby Tempered ①
VRSG-100	—	Green
VPG-100	—	Purple
VWG-100	—	White Glass
VWGP-100	—	White Tempered Glass
75 W A-19 LAMP	150 W A-21 LAMP	Polycarbonate. Cannot be used with guard or in high ambient temperature locations (40°C/104°F max.) Not UL Listed.
VPLCG-100	VPLCG-200	

① Recommended for use with VXFC fixture base.

② TM Thomas Manufacturing.



V GUARDS	
CATALOG NUMBER	DESCRIPTION
VAG-100	100 Series Vaportite guard
VAG-200	200 Series Vaportite guard

V REFLECTORS		
CATALOG NUMBER	DESCRIPTION	
VPRSD-100	100 Series Vaportite Reflector	16 3/8" Dia. 5 5/8" High. White polypropylene for pendant & ceiling applications. Not for use with wall or stanchion models.
VPRSD-200	200 Series Vaportite Reflector	



Body To Splice Box
Gasket
100 or 200 Series
VTG Standard
VTG-S Silicone (pictured)

V SERIES GASKET			
CATALOG NUMBER		TYPE	DESCRIPTION
100 SERIES	200 SERIES		
VTG		VFC	Fixture body to splice box
VTG-S		VXFC	Silicone, Fixture body to splice box
VBNB		—	Replacement Gaskets for VB-1/VB-2 and VBA
15871AABB	VTGG	VFC	Globe gasket
VTGG1-S	VTGG2-S	VFXC	Silicone, globe gasket



Globe Gasket
100 Series Standard - 15871AABB
200 Series Standard - VTGG (pictured)
100 Series Silicone - VTGG1-S
200 Series Silicone - VTGG2-S



V LAMP SOCKET	
CATALOG NUMBER	DESCRIPTION
VRME	For fixture types 100 and 200

LIGHTING



DIMENSIONS

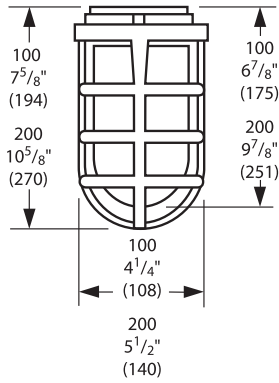

V Fixture
w/o Splice Box

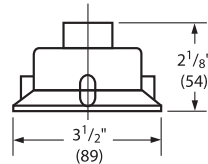

VGA

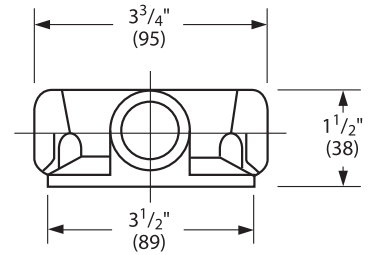

VGC VGX

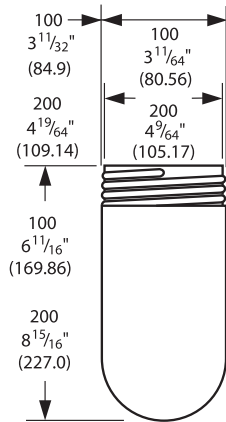

V Fixture
Globes

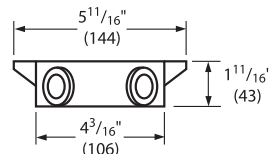

VBC-1 & VBC-2

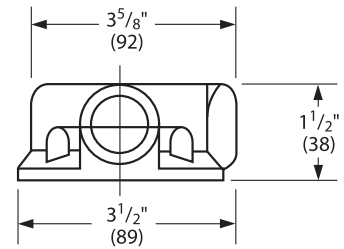

VGH

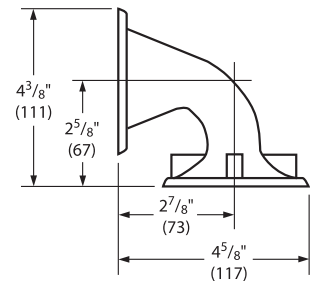
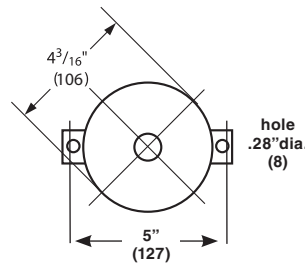

VFL

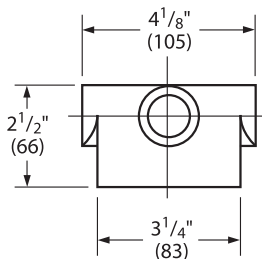

VXA

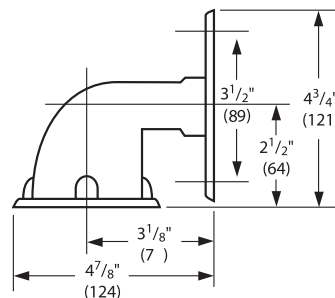

VB

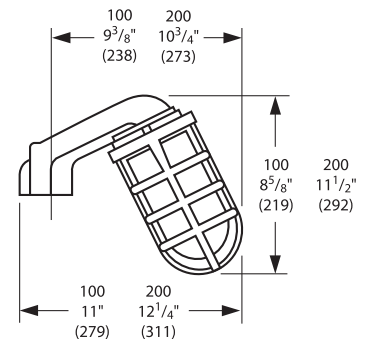

V Stanchion