

**NEW!**

# Glideloc<sup>®</sup>

Vertical Height Access Ladder System Kits

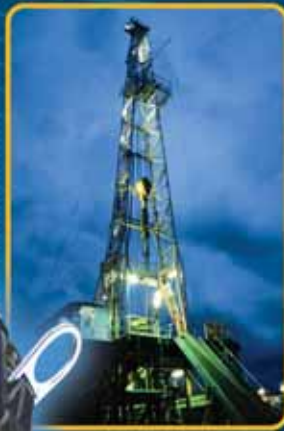

*Continuous fall protection for climbing fixed ladders*

- Unique design keeps hands free for climbing
- Engineered for smooth operation for ascending/descending
- Easy to order and install do-it-yourself kits
- Durable construction for extended service life
- Accommodates multiple workers

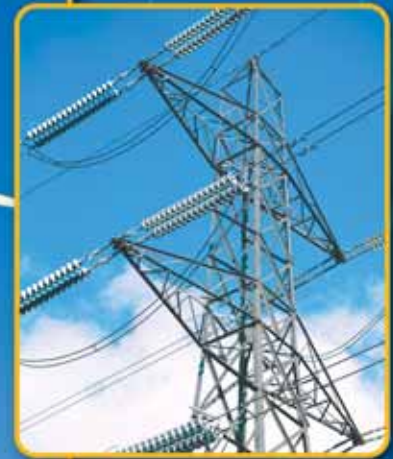

**MILLER<sup>®</sup>**  
by SPERIAN



**NEW!**

# GlideLoc® Vertical Height Access Ladder System Kits

**LONGER SERVICE LIFE THAN CABLE SYSTEMS**

New GlideLoc Vertical Height Access Ladder System Kits provide an innovative solution for vertical climbing that is easy-to-use, requires minimal maintenance and provides superior safety. Kits are available in aluminum, galvanized or stainless steel construction. The easy-climb GlideLoc System offers *hands-free* safety at height that ultimately increases worker mobility, safety and productivity.

## IDEAL FOR PERMANENT LADDER APPLICATIONS:

- Wind Power/Turbines
- Telecommunications
- Utilities
- Industrial Facilities
- Drilling Rigs/Platforms
- Shipbuilding
- Crane Installation
- Confined Space

Integrated Shock-Absorbing Element



Gated Top End-Stop

Rung Clamp\*

Vertical Rail  
Aluminum, Galvanized or Stainless Steel

Fall Arrester  
Comfort GlideLoc Fall Arrester Shown

Rung Clamp\*

Gated Bottom End-Stop

Systems are available in easy-to-install kits or can be **customized for your application** with additional available components, including:

- Brackets for larger ladder rungs
- Brackets to attach to ladder side rails
- Foldable foot rests for long ladders
- Shaft entry device to provide easy access to manholes and roof hatches

\*Minimum four (4) rung clamps required for each system.

# GlideLoc® Fall Arresters

All GlideLoc Fall Arresters lock immediately into the rail in the event of a fall. All models offer:

- **Smooth, quiet trailing action along the rail** – provides an easier, more comfortable climb
- **Automatic design** – keeps both hands free for climbing
- **Stainless steel catch clamp** – locks into the rail in the event of a fall
- **Integrated shock-absorbing mechanism** – reduces force on the worker and system in the event of a fall
- **Fall indicator** – alerts user to know when to remove the product from service
- **Integrated swivel, auto-locking carabiner connection** – aids in trailing alignment and meets allowable attachment length
- **Design prevents up-side-down installation** – increases worker safety by ensuring proper attachment
- **No requirement to lean back while climbing** – reduces fatigue; ideal for ladder cages and confined spaces
- **Ergonomically designed for easy one-hand installation** – increases productivity

**Attaches at top or bottom of rail**



**Comfort GlideLoc Fall Arrester**

- Offers all of the features listed above
- Smooth, quiet trailing action along the rail is delivered by 10 glide rollers – provides an easier, more comfortable climb
- Outside roller guides are protected by a flexible rubber ring – provides for a longer service life
- Constructed of stainless steel and aluminum – holds up well in corrosive environments

**Attaches anywhere on rail**



**Universal II GlideLoc Fall Arrester**

- Designed to be installed and removed from the rail anywhere along the system – enables transfer onto platforms and entry onto systems where ladder is submerged in snow
- Click-lock function – ensures proper installation
- No intermediate entry/exit gates are required
- Body is constructed of stainless steel – holds up well in corrosive environments

**Specially-designed for highly corrosive environments**



**Comfort II GlideLoc Fall Arrester**

- Applications which require stainless steel components with access to the ladder for entry/exit at the **top or bottom** of the rail
- Ideal for oil exploration, petrochemical, food processing, pharmaceutical, water supply, waste water, mining and coastal applications

## Innovative System Designs

- 
- 
- 
- 
- 1 Rotary Exit    2 Foldable Foot Rests    3 Turntable    4 Exit Section

*GlideLoc offers a full range of system components designed to meet the needs of complex applications. Contact Miller Engineered Solutions at 800/325-6746*

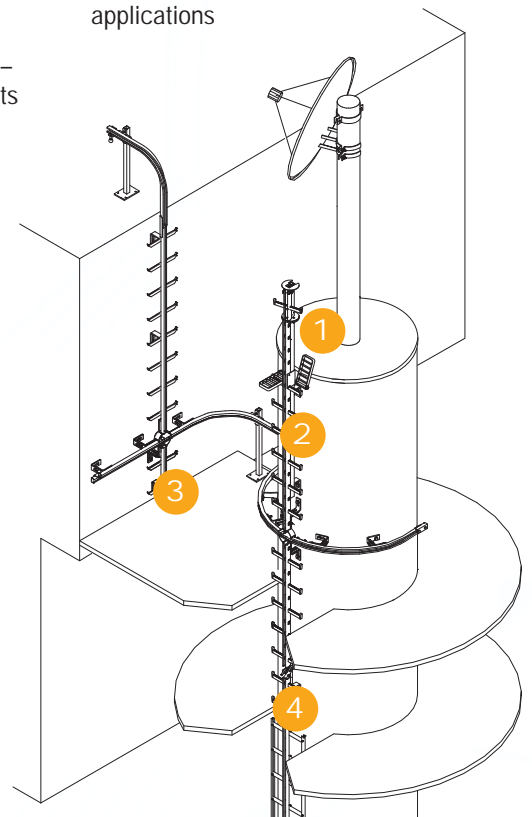



# GlideLoc® Vertical Height Access Ladder System Kits

Kits come complete with GlideLoc rail, gated top end-stop, gated bottom end-stop, ladder attachment brackets, and hardware. Systems accommodate one worker per section of rail. Kits are available in galvanized steel, aluminum and stainless steel. GlideLoc fall arresters are sold separately.







**KITS WITH LONGER LENGTHS AVAILABLE\***

SKU Galvanized	SKU Aluminum	SKU Stainless Steel	System Length	Section of 10 ft. (3.0m) Rail	Number of Ladder Attachment Brackets
GG0020	GA0020	GS0020	20 ft. (6.1m)	2	4
GG0030	GA0030	GS0030	30 ft. (9.1m)	3	6
GG0040	GA0040	GS0040	40 ft. (12.2m)	4	7
GG0050	GA0050	GS0050	50 ft. (15.2m)	5	9
GG0060	GA0060	GS0060	60 ft. (18.3m)	6	10
GG0070	GA0070	GS0070	70 ft. (21.3m)	7	11
GG0080	GA0080	GS0080	80 ft. (24.4m)	8	13
GG0090	GA0090	GS0090	90 ft. (27.4m)	9	14
GG0100	GA0100	GS0100	100 ft. (30.5m)	10	16
GG0110	GA0110	GS0110	110 ft. (33.5m)	11	17
GG0120	GA0120	GS0120	120 ft. (36.6m)	12	19
GG0130	GA0130	GS0130	130 ft. (39.6m)	13	20
GG0140	GA0140	GS0140	140 ft. (42.7m)	14	21
GG0150	GA0150	GS0150	150 ft. (45.7m)	15	23
GG0160	GA0160	GS0160	160 ft. (48.8m)	16	24
GG0170	GA0170	GS0170	170 ft. (51.8m)	17	26
GG0180	GA0180	GS0180	180 ft. (54.9m)	18	27
GG0190	GA0190	GS0190	190 ft. (58.0m)	19	29
GG0200	GA0200	GS0200	200 ft. (61.0m)	20	30



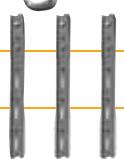
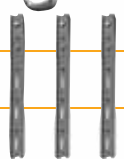
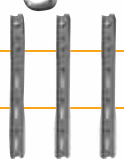

\*For longer systems, contact Miller Technical Service at 800/873-5242.

## GlideLoc® Components

### SKU Description

- 22697 **Comfort GlideLoc Fall Arrester** – locks into the rail in the event of a fall. Stainless steel and aluminum construction. 
- 23531 **Universal II GlideLoc Fall Arrester** – can be removed from the rail anywhere along the system enabling transfer onto platforms. Stainless steel and aluminum construction. 
- 23331 **Comfort II GlideLoc Fall Arrester** – locks into the rail in the event of a fall. Stainless steel construction. 
- 15729 **Aluminum Vertical Rail** – length of 10 ft. 1 in. (3.07m) 
- 14622 **Galvanized Vertical Rail** – length of 10 ft. 1 in. (3.07m) 
- 16852 **Stainless Steel Vertical Rail** – length of 10 ft. 1 in. (3.07m) 
- 21050 **Gated Top End-Stop** – for use with vertical rail. Allows for entering and exiting the system with GlideLoc fall arresters. Stainless steel construction. 
- 21049 **Gated Bottom End-Stop** – for use with vertical rail. Allows for entering and exiting the system with GlideLoc fall arresters. Stainless steel construction. 
- 11634 **Rigid End-Stop** – for use with vertical rail, prevents GlideLoc fall arresters from being removed from rail. Stainless steel construction. 

### SKU Description

- 10903 **Rung Clamp** for diameters up to 1" (25.4mm), galvanized 
- 14804 **Rung Clamp** for diameters 1" (25.4mm) to 1-1/4" (31.8mm), galvanized
- 14805 **Rung Clamp** for diameters 1-1/4" (31.8mm) to 1-3/4" (44.5mm), galvanized
- 14809 **Rung Clamp** for diameters up to 1" (25.4mm), stainless steel
- 14813 **Rung Clamp** for diameters 1" (25.4mm) to 1-1/4" (31.8mm), stainless steel
- 14814 **Rung Clamp** for diameters 1-1/4" (31.8mm) to 1-3/4" (44.5mm), stainless steel
- 19091 **Side Mount Clamp** – enables mounting rail along the side of ladder. Galvanized steel construction. 
- 17065 **Shaft Entering Device** – allows safe entry of a shaft such as a manhole. The prongs slip into coupling device (model 16191). Stainless steel construction. 
- 16191 **Shaft Entering Device Coupling** – is attached to the top of GlideLoc rail to allow use of shaft entering devices (model 17065). Stainless steel construction. 
- 23724 **Foldable Foot Rest** – provides a rest platform that conveniently folds out of the way when not in use. Galvanized steel construction. 

This equipment should only be used after reading the manufacturer's instructions. Failure to follow instructions could result in serious injury or fatality.



**Ask the Expert ... Ask Miller.**

800/873-5242  
or 814/432-2118

Fax 800/892-4078  
or Fax 814/432-2415

www.millerfallprotection.com



For more information or to place an order, please contact your Miller® distributor:

LMGK/0409/20M/RPI