

FAZ-NA and FAZ-NA-L Circuit Breakers



Optimum and Efficient Protection for Every Application

Contents

Description

	Page
FAZ-NA and FAZ-NA-L Circuit Breakers	
Catalog Number Selection	V4-T1-48
Product Selection	V4-T1-49
Accessories	V4-T1-62
Technical Data and Specifications	V4-T1-66
Dimensions	V4-T1-72

FAZ-NA and FAZ-NA-L Circuit Breakers

Product Overview

Optimum product quality, tested reliability and safety stand for best protection of personnel, installations and plant. Eaton's FAZ-NA and FAZ-NA-L DIN rail mountable circuit breakers are designed for use in branch service applications.

Powerful Offering for Machine and System Builders

FAZ-NA and FAZ-NA-L are available with B, C and D characteristics in accordance with UL® 489, CSA® C22.2 No.5; UL 1077, CSA C22.2 No.235 and IEC 60947-2. These devices are CE marked.

Application Description

Feeder and branch circuit protection for:

- Convenience receptacle circuits (internal/external)
- Motor control circuits
- Load circuits leaving the equipment (external)
- HACR internal/external equipment (heating, air conditioning, refrigeration)
- PLC I/O points
- Computers
- Power supplies
- Control instrumentation
- Relays
- UPS
- Power conditioners

Features

- Complete range of UL 489 listed DIN rail mounted miniature circuit breakers up to 63A current rating
- Two distinct UL 489 FAZ-NA offerings available to provide the best solution for the application—FAZ-NA at 277/480 Vac and FAZ-NA-L at 240 Vac
- Standard ratings of 10 kAIC available at both 240 Vac and 277/480 Vac
- Select amperages available at 14 kAIC for both the 240 Vac and 277/480 Vac offerings and 10 kAIC up to 125 Vdc per pole
- Current limiting design provides fast short-circuit interruption that reduces the let-through energy, which can damage the circuit
- Suitable for branch circuit device protection
- Thermal-magnetic overcurrent protection
 - Three levels of short-circuit protection, categorized by B, C and D curves
- Trip-free design—breaker can not be defeated by holding the handle in the ON position
- Captive screws cannot be lost
- SWD (switching duty)—suitable for switching fluorescent lighting loads ($I_n \leq 20A$)
- Fulfill UL 489, CSA C22.2 No.5 and also IEC 60947-2 Standard
- For use in applications for which UL 1077 or CSA C22.2 No.235 are also allowed
- Field-installable shunt trip and auxiliary switch subsequent mounting
- Separate version for ring-tongue connection (Type FAZ-RT), terminal screws can be removed (on both sides)
- Module width of only 17.7 mm (per pole)
- Contact Position Indicator (red/green)
- Easy installation on DIN rail
- Possibility for sealing the toggle in ON or OFF position
- Single-, two-, three- and four-pole configurations

Device Printing on Front and Side Installation options

These branch circuit breakers are available in two terminal configurations: standard box terminals that accept multiple conductors and ring-tongue terminals, ideally suited to demanding requirements of the semi-conductor industry. All breakers mount on standard 35 mm DIN rail. Bus connectors and feeder terminal facilitate mounting and wiring of multiple miniature circuit breaker arrays in control panel assemblies. These circuit breakers can also be reverse feed.

1.2

Miniature Circuit Breakers and Supplementary Protectors

UL 489 DIN Rail Miniature Circuit Breakers

1

Standards and Certifications

FAZ-NA

FAZ-NA complies with the latest national and international standards.

- UL 489
 - Standard for molded case circuit breakers (MCCB) for feeder and branch circuit protection
 - Products meet the requirements of the National Electrical Code® (NEC®)

- CSA C22.2 No.5
 - Standard for molded case circuit breakers (MCCB) for feeder and branch circuit protection (corresponds closely to UL 489 Standard)
 - Products meet the requirements of the Canadian Electrical Code (CEC)

- RoHS compliant
- VDE compliant
- ABS compliant



FAZ-NA-L

FAZ-NA-L 0.5–63A at 240 Vac comply with the following standards.

- UL 489 listed
- CSA C22.2 No. 5-02
- IEC rated
- RoHS compliant
- CCC compliant
- OVE compliant
- EAC compliant
- ABS compliant
- VDE compliant



Catalog Number Selection

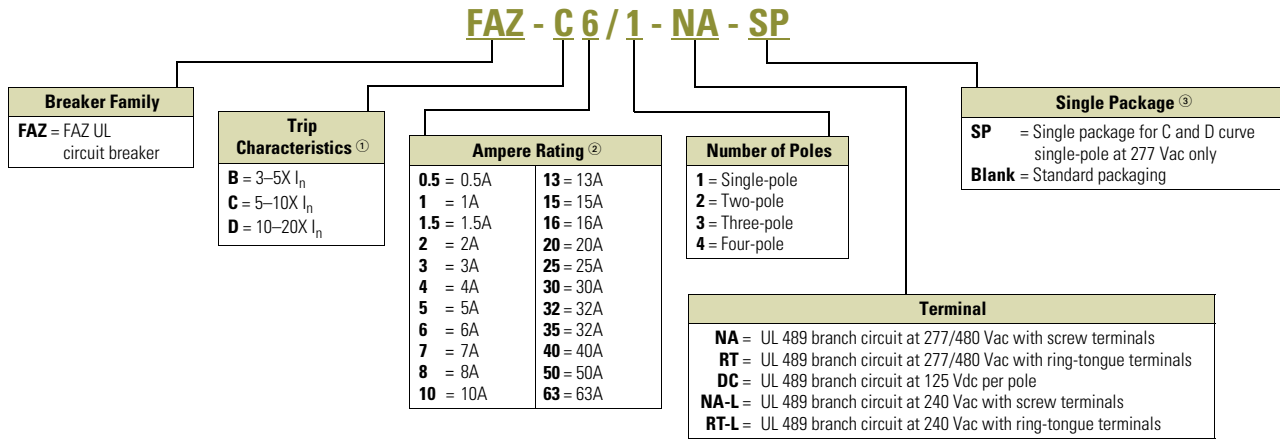

Notes

- ① I_n = Rated current for instantaneous trip characteristics.
- ② B curve starts at 1 ampere.
- ③ Single package only available for 277 Vac offering—not an option for 240 Vac line.

Product Selection

FAZ-NA B Curve 277/480 Vac Rated Offering

- UL approved (UL 489) and CSA Certified (CSA C22.2 No.5-02) as branch circuit breakers
- Interrupting capacity: 10 kA UL/CSA; 15 kA IEC 60947-2
- Current limiting device
- UL file number E235139

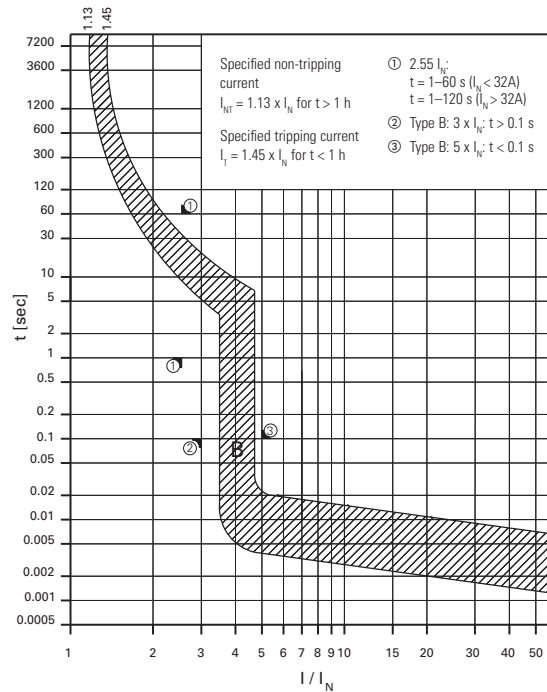

Single-Pole



Two-Pole



Three-Pole



Four-Pole



FAZ-NA UL 489 Circuit Breakers at 277/480 Vac— 10 kAIC, 14 kAIC B Curve (15–25A)

Amps	Single-Pole ① Catalog Number	Two-Pole Catalog Number	Three-Pole Catalog Number	Four-Pole Catalog Number
B Curve (3–5X I_N Current Rating)				
1	FAZ-B1/1-NA	FAZ-B1/2-NA	FAZ-B1/3-NA	FAZ-B1/4-NA
1.5	FAZ-B1.5/1-NA	FAZ-B1.5/2-NA	FAZ-B1.5/3-NA	FAZ-B1.5/4-NA
2	FAZ-B2/1-NA	FAZ-B2/2-NA	FAZ-B2/3-NA	FAZ-B2/4-NA
3	FAZ-B3/1-NA	FAZ-B3/2-NA	FAZ-B3/3-NA	FAZ-B3/4-NA
4	FAZ-B4/1-NA	FAZ-B4/2-NA	FAZ-B4/3-NA	FAZ-B4/4-NA
5	FAZ-B5/1-NA	FAZ-B5/2-NA	FAZ-B5/3-NA	FAZ-B5/4-NA
6	FAZ-B6/1-NA	FAZ-B6/2-NA	FAZ-B6/3-NA	FAZ-B6/4-NA
7	FAZ-B7/1-NA	FAZ-B7/2-NA	FAZ-B7/3-NA	FAZ-B7/4-NA
8	FAZ-B8/1-NA	FAZ-B8/2-NA	FAZ-B8/3-NA	FAZ-B8/4-NA
10	FAZ-B10/1-NA	FAZ-B10/2-NA	FAZ-B10/3-NA	FAZ-B10/4-NA
13	FAZ-B13/1-NA	FAZ-B13/2-NA	FAZ-B13/3-NA	FAZ-B13/4-NA
15	FAZ-B15/1-NA	FAZ-B15/2-NA	FAZ-B15/3-NA	FAZ-B15/4-NA
16	FAZ-B16/1-NA	FAZ-B16/2-NA	FAZ-B16/3-NA	FAZ-B16/4-NA
20	FAZ-B20/1-NA	FAZ-B20/2-NA	FAZ-B20/3-NA	FAZ-B20/4-NA
25	FAZ-B25/1-NA	FAZ-B25/2-NA	FAZ-B25/3-NA	FAZ-B25/4-NA
30	FAZ-B30/1-NA	FAZ-B30/2-NA	FAZ-B30/3-NA	FAZ-B30/4-NA
32	FAZ-B32/1-NA	FAZ-B32/2-NA	FAZ-B32/3-NA	FAZ-B32/4-NA

Note

① Two-piece order. Quantities of two per box.

1.2

Miniature Circuit Breakers and Supplementary Protectors

UL 489 DIN Rail Miniature Circuit Breakers

1

FAZ-NA B Curve 277/480 Vac Rated Offering

- UL approved (UL 489) and CSA Certified (CSA C22.2 No.5-02) as branch circuit breakers
- Interrupting capacity: 10 kA UL/CSA; 15 kA IEC 60947-2
- Current limiting device
- UL file number E235139

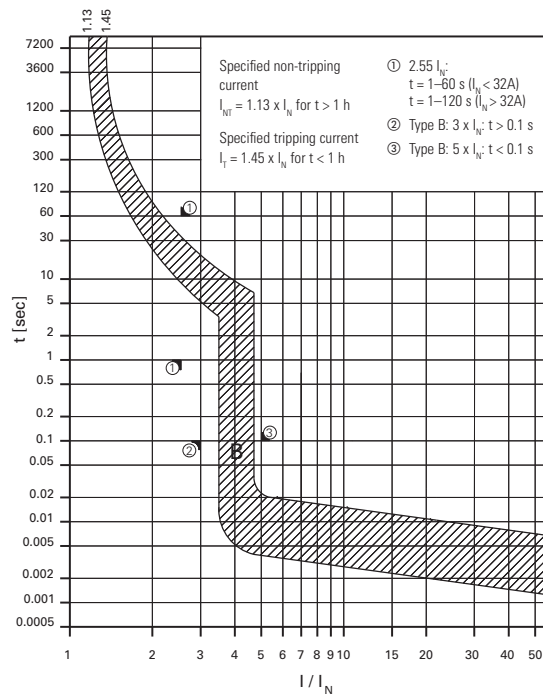

Single-Pole



Two-Pole



Three-Pole



Four-Pole



FAZ-RT UL 489 Circuit Breakers with Ring-Tongue Terminals at 277/480 Vac— 10 kAIC, 14 kAIC B Curve (15–25A)

Amps	Single-Pole ① Catalog Number	Two-Pole Catalog Number	Three-Pole Catalog Number	Four-Pole Catalog Number
B Curve with Ring-Tongue Terminals (3–5X I_N Current Rating)				
1	FAZ-B1/1-RT	FAZ-B1/2-RT	FAZ-B1/3-RT	FAZ-B1/4-RT
1.5	FAZ-B1.5/1-RT	FAZ-B1.5/2-RT	FAZ-B1.5/3-RT	FAZ-B1.5/4-RT
2	FAZ-B2/1-RT	FAZ-B2/2-RT	FAZ-B2/3-RT	FAZ-B2/4-RT
3	FAZ-B3/1-RT	FAZ-B3/2-RT	FAZ-B3/3-RT	FAZ-B3/4-RT
4	FAZ-B4/1-RT	FAZ-B4/2-RT	FAZ-B4/3-RT	FAZ-B4/4-RT
5	FAZ-B5/1-RT	FAZ-B5/2-RT	FAZ-B5/3-RT	FAZ-B5/4-RT
6	FAZ-B6/1-RT	FAZ-B6/2-RT	FAZ-B6/3-RT	FAZ-B6/4-RT
7	FAZ-B7/1-RT	FAZ-B7/2-RT	FAZ-B7/3-RT	FAZ-B7/4-RT
8	FAZ-B8/1-RT	FAZ-B8/2-RT	FAZ-B8/3-RT	FAZ-B8/4-RT
10	FAZ-B10/1-RT	FAZ-B10/2-RT	FAZ-B10/3-RT	FAZ-B10/4-RT
13	FAZ-B13/1-RT	FAZ-B13/2-RT	FAZ-B13/3-RT	FAZ-B13/4-RT
15	FAZ-B15/1-RT	FAZ-B15/2-RT	FAZ-B15/3-RT	FAZ-B15/4-RT
16	FAZ-B16/1-RT	FAZ-B16/2-RT	FAZ-B16/3-RT	FAZ-B16/4-RT
20	FAZ-B20/1-RT	FAZ-B20/2-RT	FAZ-B20/3-RT	FAZ-B20/4-RT
25	FAZ-B25/1-RT	FAZ-B25/2-RT	FAZ-B25/3-RT	FAZ-B25/4-RT
30	FAZ-B30/1-RT	FAZ-B30/2-RT	FAZ-B30/3-RT	FAZ-B30/4-RT
32	FAZ-B32/1-RT	FAZ-B32/2-RT	FAZ-B32/3-RT	FAZ-B32/4-RT

Note

① Two-piece order. Quantities of two per box.

FAZ-NA C Curve 277/480 Vac Rated Offering

- UL approved (UL 489) and CSA Certified (CSA C22.2 No.5-02) as branch circuit breakers
- Interrupting capacity: 10 kA UL/CSA; 15 kA IEC 60947-2
- Current limiting device
- UL file number E235139

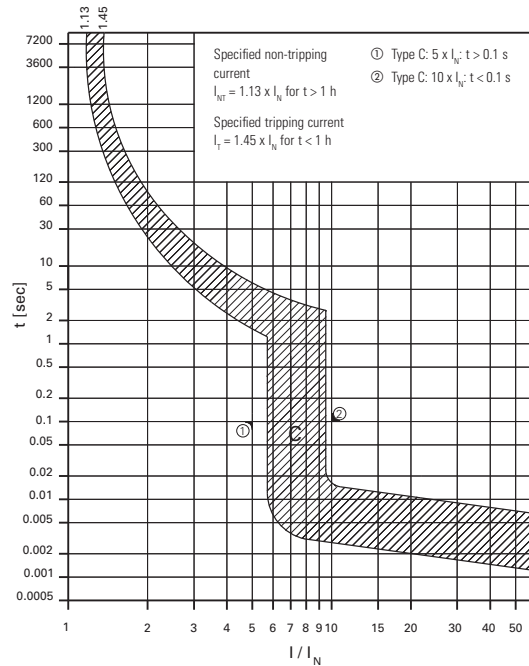

Single-Pole



Two-Pole



Three-Pole



Four-Pole



FAZ-NA UL 489 Circuit Breakers at 277/480 Vac— 10 kAIC, 14 kAIC C Curve (15–25A)

Amps	Single-Pole ① Catalog Number	Two-Pole Catalog Number	Three-Pole Catalog Number	Four-Pole Catalog Number
C Curve (5–10X I_n Current Rating)				
0.5	FAZ-C0.5/1-NA-SP	FAZ-C0.5/2-NA	FAZ-C0.5/3-NA	FAZ-C0.5/4-NA
1	FAZ-C1/1-NA-SP	FAZ-C1/2-NA	FAZ-C1/3-NA	FAZ-C1/4-NA
1.5	FAZ-C1.5/1-NA-SP	FAZ-C1.5/2-NA	FAZ-C1.5/3-NA	FAZ-C1.5/4-NA
2	FAZ-C2/1-NA-SP	FAZ-C2/2-NA	FAZ-C2/3-NA	FAZ-C2/4-NA
3	FAZ-C3/1-NA-SP	FAZ-C3/2-NA	FAZ-C3/3-NA	FAZ-C3/4-NA
4	FAZ-C4/1-NA-SP	FAZ-C4/2-NA	FAZ-C4/3-NA	FAZ-C4/4-NA
5	FAZ-C5/1-NA-SP	FAZ-C5/2-NA	FAZ-C5/3-NA	FAZ-C5/4-NA
6	FAZ-C6/1-NA-SP	FAZ-C6/2-NA	FAZ-C6/3-NA	FAZ-C6/4-NA
7	FAZ-C7/1-NA-SP	FAZ-C7/2-NA	FAZ-C7/3-NA	FAZ-C7/4-NA
8	FAZ-C8/1-NA-SP	FAZ-C8/2-NA	FAZ-C8/3-NA	FAZ-C8/4-NA
10	FAZ-C10/1-NA-SP	FAZ-C10/2-NA	FAZ-C10/3-NA	FAZ-C10/4-NA
13	FAZ-C13/1-NA-SP	FAZ-C13/2-NA	FAZ-C13/3-NA	FAZ-C13/4-NA
15	FAZ-C15/1-NA-SP	FAZ-C15/2-NA	FAZ-C15/3-NA	FAZ-C15/4-NA
16	FAZ-C16/1-NA-SP	FAZ-C16/2-NA	FAZ-C16/3-NA	FAZ-C16/4-NA
20	FAZ-C20/1-NA-SP	FAZ-C20/2-NA	FAZ-C20/3-NA	FAZ-C20/4-NA
25	FAZ-C25/1-NA-SP	FAZ-C25/2-NA	FAZ-C25/3-NA	FAZ-C25/4-NA
30	FAZ-C30/1-NA-SP	FAZ-C30/2-NA	FAZ-C30/3-NA	FAZ-C30/4-NA
32	FAZ-C32/1-NA-SP	FAZ-C32/2-NA	FAZ-C32/3-NA	FAZ-C32/4-NA

Note

① Option for single packaging on single-pole C and D curves only; add suffix SP when ordering.

1.2

Miniature Circuit Breakers and Supplementary Protectors

UL 489 DIN Rail Miniature Circuit Breakers

1

FAZ-NA C Curve 277/480 Vac Rated Offering

- UL approved (UL 489) and CSA Certified (CSA C22.2 No.5-02) as branch circuit breakers
- Interrupting capacity: 10 kA UL/CSA; 15 kA IEC 60947-2
- Current limiting device
- UL file number E235139

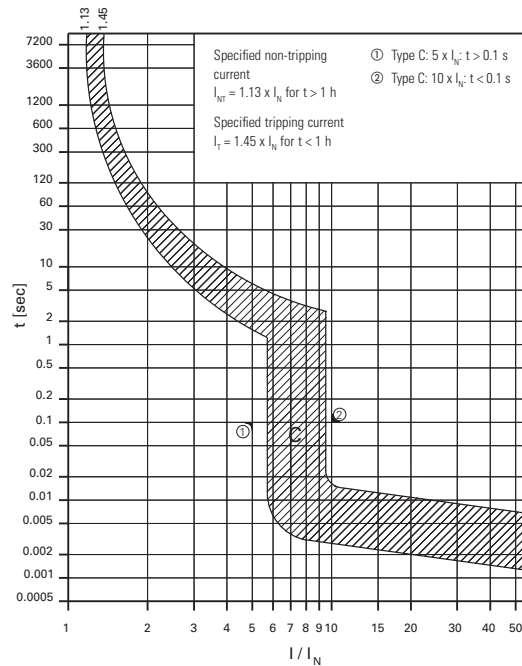

Single-Pole



Two-Pole



Three-Pole



Four-Pole



FAZ-RT UL 489 Circuit Breakers with Ring-Tongue Terminals at 277/480 Vac—10 kAIC, 14 kAIC C Curve (15–25A)

Amps	Single-Pole ^① Catalog Number	Two-Pole Catalog Number	Three-Pole Catalog Number	Four-Pole Catalog Number
C Curve with Ring-Tongue Terminals (5–10X I_N Current Rating)				
0.5	FAZ-C0.5/1-RT-SP	FAZ-C0.5/2-RT	FAZ-C0.5/3-RT	FAZ-C0.5/4-RT
1	FAZ-C1/1-RT-SP	FAZ-C1/2-RT	FAZ-C1/3-RT	FAZ-C1/4-RT
1.5	FAZ-C1.5/1-RT-SP	FAZ-C1.5/2-RT	FAZ-C1.5/3-RT	FAZ-C1.5/4-RT
2	FAZ-C2/1-RT-SP	FAZ-C2/2-RT	FAZ-C2/3-RT	FAZ-C2/4-RT
3	FAZ-C3/1-RT-SP	FAZ-C3/2-RT	FAZ-C3/3-RT	FAZ-C3/4-RT
4	FAZ-C4/1-RT-SP	FAZ-C4/2-RT	FAZ-C4/3-RT	FAZ-C4/4-RT
5	FAZ-C5/1-RT-SP	FAZ-C5/2-RT	FAZ-C5/3-RT	FAZ-C5/4-RT
6	FAZ-C6/1-RT-SP	FAZ-C6/2-RT	FAZ-C6/3-RT	FAZ-C6/4-RT
7	FAZ-C7/1-RT-SP	FAZ-C7/2-RT	FAZ-C7/3-RT	FAZ-C7/4-RT
8	FAZ-C8/1-RT-SP	FAZ-C8/2-RT	FAZ-C8/3-RT	FAZ-C8/4-RT
10	FAZ-C10/1-RT-SP	FAZ-C10/2-RT	FAZ-C10/3-RT	FAZ-C10/4-RT
13	FAZ-C13/1-RT-SP	FAZ-C13/2-RT	FAZ-C13/3-RT	FAZ-C13/4-RT
15	FAZ-C15/1-RT-SP	FAZ-C15/2-RT	FAZ-C15/3-RT	FAZ-C15/4-RT
16	FAZ-C16/1-RT-SP	FAZ-C16/2-RT	FAZ-C16/3-RT	FAZ-C16/4-RT
20	FAZ-C20/1-RT-SP	FAZ-C20/2-RT	FAZ-C20/3-RT	FAZ-C20/4-RT
25	FAZ-C25/1-RT-SP	FAZ-C25/2-RT	FAZ-C25/3-RT	FAZ-C25/4-RT
30	FAZ-C30/1-RT-SP	FAZ-C30/2-RT	FAZ-C30/3-RT	FAZ-C30/4-RT
32	FAZ-C32/1-RT-SP	FAZ-C32/2-RT	FAZ-C32/3-RT	FAZ-C32/4-RT

Note

^① Option for single packaging on single-pole C and D curves only.

FAZ-NA D Curve 277/480 Vac Rated Offering

- UL approved (UL 489) and CSA Certified (CSA C22.2 No.5-02) as branch circuit breakers
- Interrupting capacity: 10 kA UL/CSA; 15 kA IEC 60947-2
- Current limiting device
- UL file number E235139

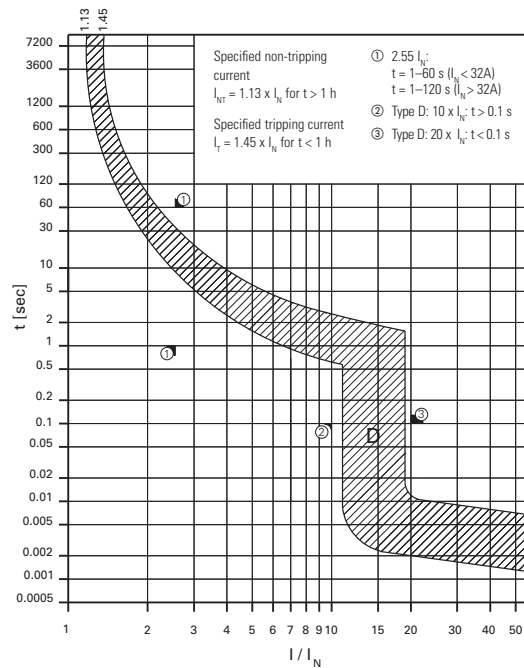

Single-Pole



Two-Pole



Three-Pole



Four-Pole



FAZ-NA UL 489 Circuit Breakers at 277/480 Vac— 10 kAIC, 14 kAIC D Curve (13–20A)

Amps	Single-Pole ① Catalog Number	Two-Pole Catalog Number	Three-Pole Catalog Number	Four-Pole Catalog Number
D Curve (10–20X I_n Current Rating)				
0.5	FAZ-D0.5/1-NA-SP	FAZ-D0.5/2-NA	FAZ-D0.5/3-NA	FAZ-D0.5/4-NA
1	FAZ-D1/1-NA-SP	FAZ-D1/2-NA	FAZ-D1/3-NA	FAZ-D1/4-NA
1.5	FAZ-D1.5/1-NA-SP	FAZ-D1.5/2-NA	FAZ-D1.5/3-NA	FAZ-D1.5/4-NA
2	FAZ-D2/1-NA-SP	FAZ-D2/2-NA	FAZ-D2/3-NA	FAZ-D2/4-NA
3	FAZ-D3/1-NA-SP	FAZ-D3/2-NA	FAZ-D3/3-NA	FAZ-D3/4-NA
4	FAZ-D4/1-NA-SP	FAZ-D4/2-NA	FAZ-D4/3-NA	FAZ-D4/4-NA
5	FAZ-D5/1-NA-SP	FAZ-D5/2-NA	FAZ-D5/3-NA	FAZ-D5/4-NA
6	FAZ-D6/1-NA-SP	FAZ-D6/2-NA	FAZ-D6/3-NA	FAZ-D6/4-NA
7	FAZ-D7/1-NA-SP	FAZ-D7/2-NA	FAZ-D7/3-NA	FAZ-D7/4-NA
8	FAZ-D8/1-NA-SP	FAZ-D8/2-NA	FAZ-D8/3-NA	FAZ-D8/4-NA
10	FAZ-D10/1-NA-SP	FAZ-D10/2-NA	FAZ-D10/3-NA	FAZ-D10/4-NA
13	FAZ-D13/1-NA-SP	FAZ-D13/2-NA	FAZ-D13/3-NA	FAZ-D13/4-NA
15	FAZ-D15/1-NA-SP	FAZ-D15/2-NA	FAZ-D15/3-NA	FAZ-D15/4-NA
16	FAZ-D16/1-NA-SP	FAZ-D16/2-NA	FAZ-D16/3-NA	FAZ-D16/4-NA
20	FAZ-D20/1-NA-SP	FAZ-D20/2-NA	FAZ-D20/3-NA	FAZ-D20/4-NA
25	FAZ-D25/1-NA-SP	FAZ-D25/2-NA	FAZ-D25/3-NA	FAZ-D25/4-NA
30	FAZ-D30/1-NA-SP	FAZ-D30/2-NA	FAZ-D30/3-NA	FAZ-D30/4-NA
32	FAZ-D32/1-NA-SP	FAZ-D32/2-NA	FAZ-D32/3-NA	FAZ-D32/4-NA

Note

① Option for single packaging on single-pole C and D curves only.

1.2

Miniature Circuit Breakers and Supplementary Protectors

UL 489 DIN Rail Miniature Circuit Breakers

1

FAZ-NA D Curve 277/480 Vac Rated Offering

- UL approved (UL 489) and CSA Certified (CSA C22.2 No.5-02) as branch circuit breakers
- Interrupting capacity: 10 kA UL/CSA; 15 kA IEC 60947-2
- Current limiting device
- UL file number E235139

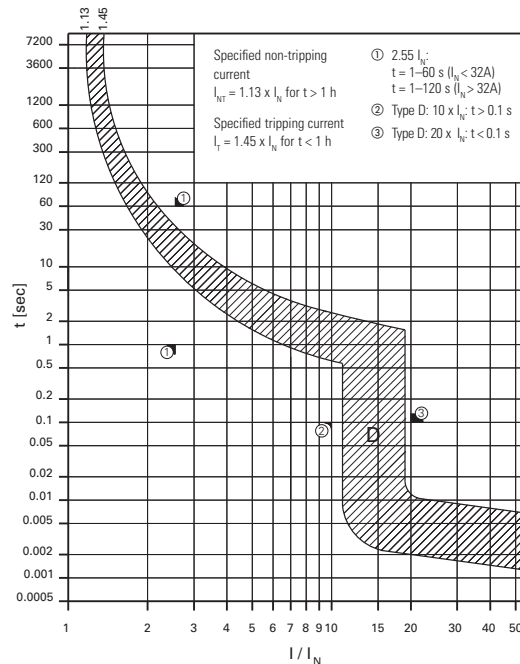

Single-Pole



Two-Pole



Three-Pole



Four-Pole



FAZ-RT UL 489 Circuit Breakers with Ring-Tongue Terminals at 277/480 Vac— 10 kAIC, 14 kAIC D Curve (13–20A)

Amps	Single-Pole Catalog Number	Two-Pole Catalog Number	Three-Pole Catalog Number	Four-Pole Catalog Number
D Curve with Ring-Tongue Terminals (10–20X I_N Current Rating)				
0.5	FAZ-D0.5/1-RT-SP	FAZ-D0.5/2-RT	FAZ-D0.5/3-RT	FAZ-D0.5/4-RT
1	FAZ-D1/1-RT-SP	FAZ-D1/2-RT	FAZ-D1/3-RT	FAZ-D1/4-RT
1.5	FAZ-D1.5/1-RT-SP	FAZ-D1.5/2-RT	FAZ-D1.5/3-RT	FAZ-D1.5/4-RT
2	FAZ-D2/1-RT-SP	FAZ-D2/2-RT	FAZ-D2/3-RT	FAZ-D2/4-RT
3	FAZ-D3/1-RT-SP	FAZ-D3/2-RT	FAZ-D3/3-RT	FAZ-D3/4-RT
4	FAZ-D4/1-RT-SP	FAZ-D4/2-RT	FAZ-D4/3-RT	FAZ-D4/4-RT
5	FAZ-D5/1-RT-SP	FAZ-D5/2-RT	FAZ-D5/3-RT	FAZ-D5/4-RT
6	FAZ-D6/1-RT-SP	FAZ-D6/2-RT	FAZ-D6/3-RT	FAZ-D6/4-RT
7	FAZ-D7/1-RT-SP	FAZ-D7/2-RT	FAZ-D7/3-RT	FAZ-D7/4-RT
8	FAZ-D8/1-RT-SP	FAZ-D8/2-RT	FAZ-D8/3-RT	FAZ-D8/4-RT
10	FAZ-D10/1-RT-SP	FAZ-D10/2-RT	FAZ-D10/3-RT	FAZ-D10/4-RT
13	FAZ-D13/1-RT-SP	FAZ-D13/2-RT	FAZ-D13/3-RT	FAZ-D13/4-RT
15	FAZ-D15/1-RT-SP	FAZ-D15/2-RT	FAZ-D15/3-RT	FAZ-D15/4-RT
16	FAZ-D16/1-RT-SP	FAZ-D16/2-RT	FAZ-D16/3-RT	FAZ-D16/4-RT
20	FAZ-D20/1-RT-SP	FAZ-D20/2-RT	FAZ-D20/3-RT	FAZ-D20/4-RT
25	FAZ-D25/1-RT-SP	FAZ-D25/2-RT	FAZ-D25/3-RT	FAZ-D25/4-RT
30	FAZ-D30/1-RT-SP	FAZ-D30/2-RT	FAZ-D30/3-RT	FAZ-D30/4-RT
32	FAZ-D32/1-RT-SP	FAZ-D32/2-RT	FAZ-D32/3-RT	FAZ-D32/4-RT

Note

① Option for single packaging on single-pole C and D curves only.

FAZ-NA-DC C Curve at 125 Vdc per Pole Offering

- UL approved (UL 489) and CSA Certified (CSA C22.2 No.5-02) as Branch Circuit Breakers
- Interrupting capacity: 10 kA at 125 Vdc UL/CSA, 10 kA at 250 Vdc
- 125 Vdc for one-pole, 250 Vdc for two-pole in series
- Current limiting device
- Polarity (+/-) sensitive and not for use on photovoltaic string application
- UL file number E235139

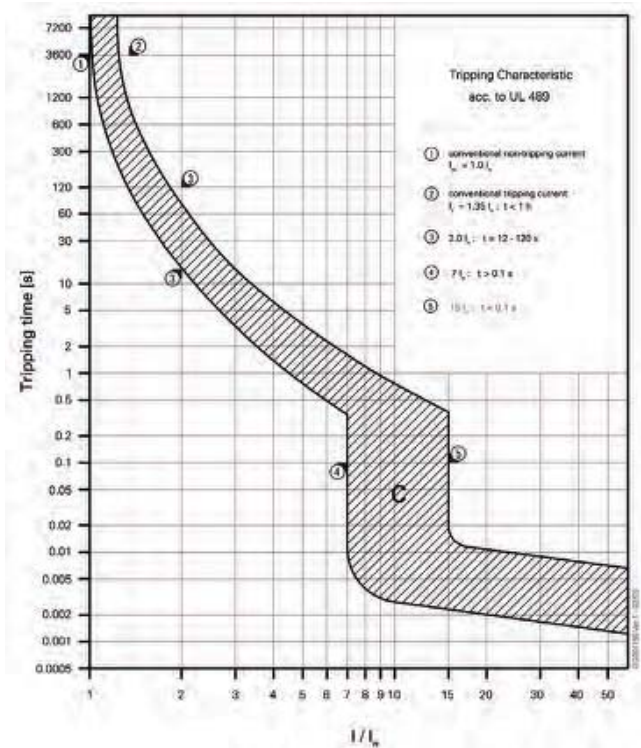

Single-Pole



Two-Pole



FAZ-NA-DC UL 489 Circuit Breakers—10 kAIC at 125 Vdc Per Pole

Amps	Single-Pole ① Catalog Number	Two-Pole Catalog Number
C Curve (5–10X I_n Current Rating)		
2	FAZ-C2/1-NA-DC-SP	FAZ-C2/2-NA-DC
3	FAZ-C3/1-NA-DC-SP	FAZ-C3/2-NA-DC
4	FAZ-C4/1-NA-DC-SP	FAZ-C4/2-NA-DC
5	FAZ-C5/1-NA-DC-SP	FAZ-C5/2-NA-DC
6	FAZ-C6/1-NA-DC-SP	FAZ-C6/2-NA-DC
7	FAZ-C7/1-NA-DC-SP	FAZ-C7/2-NA-DC
8	FAZ-C8/1-NA-DC-SP	FAZ-C8/2-NA-DC
10	FAZ-C10/1-NA-DC-SP	FAZ-C10/2-NA-DC
13	FAZ-C13/1-NA-DC-SP	FAZ-C13/2-NA-DC
15	FAZ-C15/1-NA-DC-SP	FAZ-C15/2-NA-DC
16	FAZ-C16/1-NA-DC-SP	FAZ-C16/2-NA-DC
20	FAZ-C20/1-NA-DC-SP	FAZ-C20/2-NA-DC
25	FAZ-C25/1-NA-DC-SP	FAZ-C25/2-NA-DC
30	FAZ-C30/1-NA-DC-SP	FAZ-C30/2-NA-DC
32	FAZ-C32/1-NA-DC-SP	FAZ-C32/2-NA-DC
35	FAZ-C35/1-NA-DC-SP	FAZ-C35/2-NA-DC
40	FAZ-C40/1-NA-DC-SP	FAZ-C40/2-NA-DC

Note

① Option for single packaging on single-pole C curves only; add suffix SP when ordering.

1.2

Miniature Circuit Breakers and Supplementary Protectors

UL 489 DIN Rail Miniature Circuit Breakers

1 FAZ-NA-L UL 489 Circuit Breakers at 240 Vac—10 kAIC B Curve

- UL approved (UL 489) and CSA Certified (CSA C22.2 No.5-02) as branch circuit breakers
- Interrupting capacity: 10 kA UL/CSA; 15 kA IEC 60947-2
- 48 Vdc for single-pole
- Current limiting device
- UL file number E235139

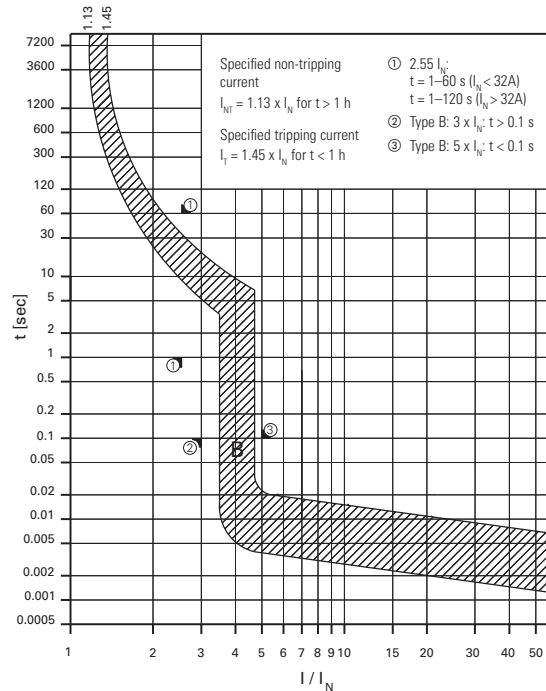

Single-Pole



Two-Pole



Three-Pole



Four-Pole



FAZ-NA-L UL 489 Circuit Breakers at 240 Vac— 10 kAIC, 14 kAIC B Curve (15–25A)

Amps	Single-Pole ① Catalog Number	Two-Pole Catalog Number	Three-Pole Catalog Number	Four-Pole Catalog Number
B Curve (3–5X I_N Current Rating)				
1	FAZ-B1/1-NA-L	FAZ-B1/2-NA-L	FAZ-B1/3-NA-L	FAZ-B1/4-NA-L
1.5	FAZ-B1.5/1-NA-L	FAZ-B1.5/2-NA-L	FAZ-B1.5/3-NA-L	FAZ-B1.5/4-NA-L
2	FAZ-B2/1-NA-L	FAZ-B2/2-NA-L	FAZ-B2/3-NA-L	FAZ-B2/4-NA-L
3	FAZ-B3/1-NA-L	FAZ-B3/2-NA-L	FAZ-B3/3-NA-L	FAZ-B3/4-NA-L
4	FAZ-B4/1-NA-L	FAZ-B4/2-NA-L	FAZ-B4/3-NA-L	FAZ-B4/4-NA-L
5	FAZ-B5/1-NA-L	FAZ-B5/2-NA-L	FAZ-B5/3-NA-L	FAZ-B5/4-NA-L
6	FAZ-B6/1-NA-L	FAZ-B6/2-NA-L	FAZ-B6/3-NA-L	FAZ-B6/4-NA-L
7	FAZ-B7/1-NA-L	FAZ-B7/2-NA-L	FAZ-B7/3-NA-L	FAZ-B7/4-NA-L
8	FAZ-B8/1-NA-L	FAZ-B8/2-NA-L	FAZ-B8/3-NA-L	FAZ-B8/4-NA-L
10	FAZ-B10/1-NA-L	FAZ-B10/2-NA-L	FAZ-B10/3-NA-L	FAZ-B10/4-NA-L
13	FAZ-B13/1-NA-L	FAZ-B13/2-NA-L	FAZ-B13/3-NA-L	FAZ-B13/4-NA-L
15	FAZ-B15/1-NA-L	FAZ-B15/2-NA-L	FAZ-B15/3-NA-L	FAZ-B15/4-NA-L
16	FAZ-B16/1-NA-L	FAZ-B16/2-NA-L	FAZ-B16/3-NA-L	FAZ-B16/4-NA-L
20	FAZ-B20/1-NA-L	FAZ-B20/2-NA-L	FAZ-B20/3-NA-L	FAZ-B20/4-NA-L
25	FAZ-B25/1-NA-L	FAZ-B25/2-NA-L	FAZ-B25/3-NA-L	FAZ-B25/4-NA-L
30	FAZ-B30/1-NA-L	FAZ-B30/2-NA-L	FAZ-B30/3-NA-L	FAZ-B30/4-NA-L
32	FAZ-B32/1-NA-L	FAZ-B32/2-NA-L	FAZ-B32/3-NA-L	FAZ-B32/4-NA-L
35 ②	FAZ-B35/1-NA	FAZ-B35/2-NA	FAZ-B35/3-NA	FAZ-B35/4-NA
40 ②	FAZ-B40/1-NA	FAZ-B40/2-NA	FAZ-B40/3-NA	FAZ-B40/4-NA
50	FAZ-B50/1-NA	FAZ-B50/2-NA	FAZ-B50/3-NA	FAZ-B50/4-NA
63	FAZ-B63/1-NA	FAZ-B63/2-NA	FAZ-B63/3-NA	FAZ-B63/4-NA

Notes

① Two-piece order. Quantities of two per box.

② 35A and 40A at 240 Vac were available prior to the creation of the FAZ-NA-L offering so the catalog numbers at these amperages exclude the “L” suffix.

FAZ-NA-L UL 489 Circuit Breakers at 240 Vac—10 kAIC B Curve

- UL approved (UL 489) and CSA Certified (CSA C22.2 No.5-02) as branch circuit breakers
- Interrupting capacity: 10 kA UL/CSA; 15 kA IEC 60947-2
- 48 Vdc for single-pole
- Current limiting device
- UL file number E235139

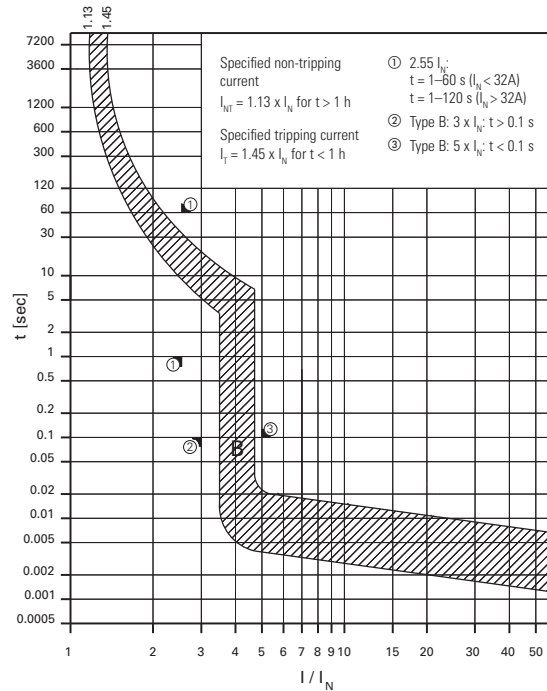

Single-Pole



Two-Pole



Three-Pole



Four-Pole



FAZ-RT-L UL 489 Circuit Breakers with Ring-Tongue Terminals at 240 Vac— 10 kAIC, 14 kAIC B Curve (15–25A)

Amps	Single-Pole ① Catalog Number	Two-Pole Catalog Number	Three-Pole Catalog Number	Four-Pole Catalog Number
B Curve with Ring-Tongue Terminals (3–5X I_n Current Rating)				
1	FAZ-B1/1-RT-L	FAZ-B1/2-RT-L	FAZ-B1/3-RT-L	FAZ-B1/4-RT-L
1.5	FAZ-B1.5/1-RT-L	FAZ-B1.5/2-RT-L	FAZ-B1.5/3-RT-L	FAZ-B1.5/4-RT-L
2	FAZ-B2/1-RT-L	FAZ-B2/2-RT-L	FAZ-B2/3-RT-L	FAZ-B2/4-RT-L
3	FAZ-B3/1-RT-L	FAZ-B3/2-RT-L	FAZ-B3/3-RT-L	FAZ-B3/4-RT-L
4	FAZ-B4/1-RT-L	FAZ-B4/2-RT-L	FAZ-B4/3-RT-L	FAZ-B4/4-RT-L
5	FAZ-B5/1-RT-L	FAZ-B5/2-RT-L	FAZ-B5/3-RT-L	FAZ-B5/4-RT-L
6	FAZ-B6/1-RT-L	FAZ-B6/2-RT-L	FAZ-B6/3-RT-L	FAZ-B6/4-RT-L
7	FAZ-B7/1-RT-L	FAZ-B7/2-RT-L	FAZ-B7/3-RT-L	FAZ-B7/4-RT-L
8	FAZ-B8/1-RT-L	FAZ-B8/2-RT-L	FAZ-B8/3-RT-L	FAZ-B8/4-RT-L
10	FAZ-B10/1-RT-L	FAZ-B10/2-RT-L	FAZ-B10/3-RT-L	FAZ-B10/4-RT-L
13	FAZ-B13/1-RT-L	FAZ-B13/2-RT-L	FAZ-B13/3-RT-L	FAZ-B13/4-RT-L
15	FAZ-B15/1-RT-L	FAZ-B15/2-RT-L	FAZ-B15/3-RT-L	FAZ-B15/4-RT-L
16	FAZ-B16/1-RT-L	FAZ-B16/2-RT-L	FAZ-B16/3-RT-L	FAZ-B16/4-RT-L
20	FAZ-B20/1-RT-L	FAZ-B20/2-RT-L	FAZ-B20/3-RT-L	FAZ-B20/4-RT-L
25	FAZ-B25/1-RT-L	FAZ-B25/2-RT-L	FAZ-B25/3-RT-L	FAZ-B25/4-RT-L
30	FAZ-B30/1-RT-L	FAZ-B30/2-RT-L	FAZ-B30/3-RT-L	FAZ-B30/4-RT-L
32	FAZ-B32/1-RT-L	FAZ-B32/2-RT-L	FAZ-B32/3-RT-L	FAZ-B32/4-RT-L
35 ②	FAZ-B35/1-RT	FAZ-B35/2-RT	FAZ-B35/3-RT	FAZ-B35/4-RT
40 ②	FAZ-B40/1-RT	FAZ-B40/2-RT	FAZ-B40/3-RT	FAZ-B40/4-RT
50	FAZ-B50/1-RT	FAZ-B50/2-RT	FAZ-B50/3-RT	FAZ-B50/4-RT
63	FAZ-B63/1-RT	FAZ-B63/2-RT	FAZ-B63/3-RT	FAZ-B63/4-RT

Notes

① Two-piece order. Quantities of two per box.

② 35A and 40A at 240 Vac were available prior to the creation of the FAZ-NA-L offering so the catalog numbers at these amperages exclude the “L” suffix.

1 FAZ-NA-L UL 489 Circuit Breakers at 240 Vac—10 kAIC C Curve

- UL approved (UL 489) and CSA Certified (CSA C22.2 No.5-02) as branch circuit breakers
- Interrupting capacity: 10 kA UL/CSA; 15 kA IEC 60947-2
- 48 Vdc for single-pole
- Current limiting device
- UL file number E235139

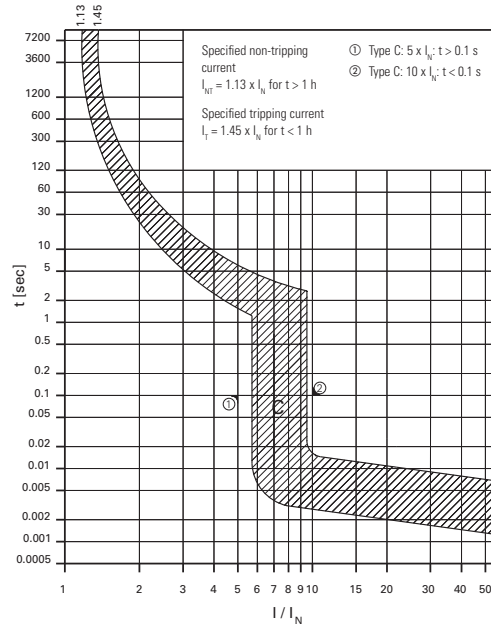

Single-Pole



Two-Pole



Three-Pole



Four-Pole



FAZ-NA-L UL 489 Circuit Breakers at 240 Vac—10 kAIC, 14 kAIC C Curve (15–25A)

Amps	Single-Pole ^① Catalog Number	Two-Pole Catalog Number	Three-Pole Catalog Number	Four-Pole Catalog Number
C Curve (5–10X I_N Current Rating)				
0.5	FAZ-C0.5/1-NA-L	FAZ-C0.5/2-NA-L	FAZ-C0.5/3-NA-L	FAZ-C0.5/4-NA-L
1	FAZ-C1/1-NA-L	FAZ-C1/2-NA-L	FAZ-C1/3-NA-L	FAZ-C1/4-NA-L
1.5	FAZ-C1.5/1-NA-L	FAZ-C1.5/2-NA-L	FAZ-C1.5/3-NA-L	FAZ-C1.5/4-NA-L
2	FAZ-C2/1-NA-L	FAZ-C2/2-NA-L	FAZ-C2/3-NA-L	FAZ-C2/4-NA-L
3	FAZ-C3/1-NA-L	FAZ-C3/2-NA-L	FAZ-C3/3-NA-L	FAZ-C3/4-NA-L
4	FAZ-C4/1-NA-L	FAZ-C4/2-NA-L	FAZ-C4/3-NA-L	FAZ-C4/4-NA-L
5	FAZ-C5/1-NA-L	FAZ-C5/2-NA-L	FAZ-C5/3-NA-L	FAZ-C5/4-NA-L
6	FAZ-C6/1-NA-L	FAZ-C6/2-NA-L	FAZ-C6/3-NA-L	FAZ-C6/4-NA-L
7	FAZ-C7/1-NA-L	FAZ-C7/2-NA-L	FAZ-C7/3-NA-L	FAZ-C7/4-NA-L
8	FAZ-C8/1-NA-L	FAZ-C8/2-NA-L	FAZ-C8/3-NA-L	FAZ-C8/4-NA-L
10	FAZ-C10/1-NA-L	FAZ-C10/2-NA-L	FAZ-C10/3-NA-L	FAZ-C10/4-NA-L
13	FAZ-C13/1-NA-L	FAZ-C13/2-NA-L	FAZ-C13/3-NA-L	FAZ-C13/4-NA-L
15	FAZ-C15/1-NA-L	FAZ-C15/2-NA-L	FAZ-C15/3-NA-L	FAZ-C15/4-NA-L
16	FAZ-C16/1-NA-L	FAZ-C16/2-NA-L	FAZ-C16/3-NA-L	FAZ-C16/4-NA-L
20	FAZ-C20/1-NA-L	FAZ-C20/2-NA-L	FAZ-C20/3-NA-L	FAZ-C20/4-NA-L
25	FAZ-C25/1-NA-L	FAZ-C25/2-NA-L	FAZ-C25/3-NA-L	FAZ-C25/4-NA-L
30	FAZ-C30/1-NA-L	FAZ-C30/2-NA-L	FAZ-C30/3-NA-L	FAZ-C30/4-NA-L
32	FAZ-C32/1-NA-L	FAZ-C32/2-NA-L	FAZ-C32/3-NA-L	FAZ-C32/4-NA-L
35 ^②	FAZ-C35/1-NA-SP	FAZ-C35/2-NA	FAZ-C35/3-NA	FAZ-C35/4-NA
40 ^②	FAZ-C40/1-NA-SP	FAZ-C40/2-NA	FAZ-C40/3-NA	FAZ-C40/4-NA
50	FAZ-C50/1-NA	FAZ-C50/2-NA	FAZ-C50/3-NA	FAZ-C50/4-NA
63	FAZ-C63/1-NA	FAZ-C63/2-NA	FAZ-C63/3-NA	FAZ-C63/4-NA

Notes

^① Two-piece order. Quantities of two per box.

^② 35A and 40A at 240 Vac were available prior to the creation of the FAZ-NA-L offering so the catalog numbers at these amperages exclude the “L” suffix.

FAZ-NA-L UL 489 Circuit Breakers at 240 Vac—10 kAIC C Curve

- UL approved (UL 489) and CSA Certified (CSA C22.2 No.5-02) as branch circuit breakers
- Interrupting capacity: 10 kA UL/CSA; 15 kA IEC 60947-2
- 48 Vdc for single-pole
- Current limiting device
- UL file number E235139

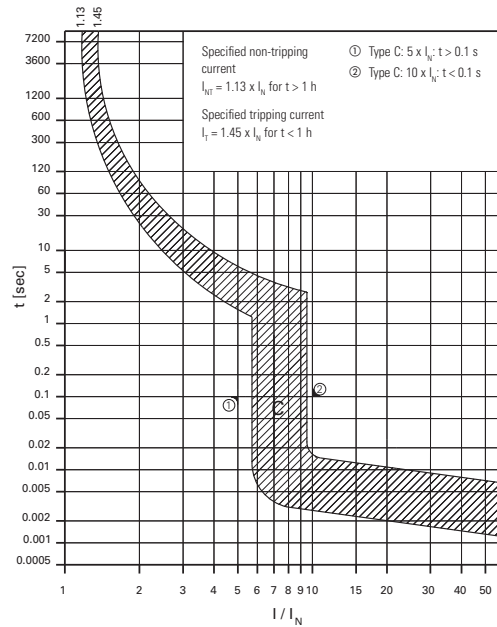

Single-Pole



Two-Pole



Three-Pole



Four-Pole



FAZ-RT-L UL 489 Circuit Breakers with Ring-Tongue Terminals at 240 Vac—10 kAIC, 14 kAIC C Curve (15–25A)

Amps	Single-Pole Catalog Number ①	Two-Pole Catalog Number	Three-Pole Catalog Number	Four-Pole Catalog Number
C Curve with Ring-Tongue Terminals (5–10X I_N Current Rating)				
0.5	FAZ-C0.5/1-RT-L	FAZ-C0.5/2-RT-L	FAZ-C0.5/3-RT-L	FAZ-C0.5/4-RT-L
1	FAZ-C1/1-RT-L	FAZ-C1/2-RT-L	FAZ-C1/3-RT-L	FAZ-C1/4-RT-L
1.5	FAZ-C1.5/1-RT-L	FAZ-C1.5/2-RT-L	FAZ-C1.5/3-RT-L	FAZ-C1.5/4-RT-L
2	FAZ-C2/1-RT-L	FAZ-C2/2-RT-L	FAZ-C2/3-RT-L	FAZ-C2/4-RT-L
3	FAZ-C3/1-RT-L	FAZ-C3/2-RT-L	FAZ-C3/3-RT-L	FAZ-C3/4-RT-L
4	FAZ-C4/1-RT-L	FAZ-C4/2-RT-L	FAZ-C4/3-RT-L	FAZ-C4/4-RT-L
5	FAZ-C5/1-RT-L	FAZ-C5/2-RT-L	FAZ-C5/3-RT-L	FAZ-C5/4-RT-L
6	FAZ-C6/1-RT-L	FAZ-C6/2-RT-L	FAZ-C6/3-RT-L	FAZ-C6/4-RT-L
7	FAZ-C7/1-RT-L	FAZ-C7/2-RT-L	FAZ-C7/3-RT-L	FAZ-C7/4-RT-L
8	FAZ-C8/1-RT-L	FAZ-C8/2-RT-L	FAZ-C8/3-RT-L	FAZ-C8/4-RT-L
10	FAZ-C10/1-RT-L	FAZ-C10/2-RT-L	FAZ-C10/3-RT-L	FAZ-C10/4-RT-L
13	FAZ-C13/1-RT-L	FAZ-C13/2-RT-L	FAZ-C13/3-RT-L	FAZ-C13/4-RT-L
15	FAZ-C15/1-RT-L	FAZ-C15/2-RT-L	FAZ-C15/3-RT-L	FAZ-C15/4-RT-L
16	FAZ-C16/1-RT-L	FAZ-C16/2-RT-L	FAZ-C16/3-RT-L	FAZ-C16/4-RT-L
20	FAZ-C20/1-RT-L	FAZ-C20/2-RT-L	FAZ-C20/3-RT-L	FAZ-C20/4-RT-L
25	FAZ-C25/1-RT-L	FAZ-C25/2-RT-L	FAZ-C25/3-RT-L	FAZ-C25/4-RT-L
30	FAZ-C30/1-RT-L	FAZ-C30/2-RT-L	FAZ-C30/3-RT-L	FAZ-C30/4-RT-L
32	FAZ-C32/1-RT-L	FAZ-C32/2-RT-L	FAZ-C32/3-RT-L	FAZ-C32/4-RT-L
35 ②	FAZ-C35/1-RT-SP	FAZ-C35/2-RT	FAZ-C35/3-RT	FAZ-C35/4-RT
40 ②	FAZ-C40/1-RT-SP	FAZ-C40/2-RT	FAZ-C40/3-RT	FAZ-C40/4-RT
50	FAZ-C50/1-RT	FAZ-C50/2-RT	FAZ-C50/3-RT	FAZ-C50/4-RT
63	FAZ-C63/1-RT	FAZ-C63/2-RT	FAZ-C63/3-RT	FAZ-C63/4-RT

Notes

① Two-piece order. Quantities of two per box.

② 35A and 40A at 240 Vac were available prior to the creation of the FAZ-NA-L offering so the catalog numbers at these amperages exclude the "L" suffix.

1 FAZ-NA-L UL 489 Circuit Breakers at 240 Vac—10 kAIC D Curve

- UL approved (UL 489) and CSA Certified (CSA C22.2 No.5-02) as branch circuit breakers
- Interrupting capacity: 10 kA UL/CSA; 15 kA IEC 60947-2
- 48 Vdc for single-pole
- Current limiting device
- UL file number E235139

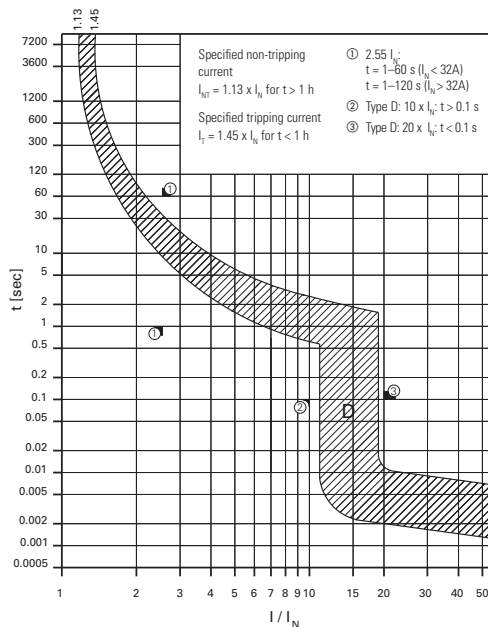

Single-Pole



Two-Pole



Three-Pole



Four-Pole



FAZ-NA-L UL 489 Circuit Breakers at 240 Vac—10 kAIC, 14 kAIC D Curve (13–20A)

Amps	Single-Pole ① Catalog Number	Two-Pole Catalog Number	Three-Pole Catalog Number	Four-Pole Catalog Number
D Curve (10–20X I_N Current Rating)				
0.5	FAZ-D0.5/1-NA-L	FAZ-D0.5/2-NA-L	FAZ-D0.5/3-NA-L	FAZ-D0.5/4-NA-L
1	FAZ-D1/1-NA-L	FAZ-D1/2-NA-L	FAZ-D1/3-NA-L	FAZ-D1/4-NA-L
1.5	FAZ-D1.5/1-NA-L	FAZ-D1.5/2-NA-L	FAZ-D1.5/3-NA-L	FAZ-D1.5/4-NA-L
2	FAZ-D2/1-NA-L	FAZ-D2/2-NA-L	FAZ-D2/3-NA-L	FAZ-D2/4-NA-L
3	FAZ-D3/1-NA-L	FAZ-D3/2-NA-L	FAZ-D3/3-NA-L	FAZ-D3/4-NA-L
4	FAZ-D4/1-NA-L	FAZ-D4/2-NA-L	FAZ-D4/3-NA-L	FAZ-D4/4-NA-L
5	FAZ-D5/1-NA-L	FAZ-D5/2-NA-L	FAZ-D5/3-NA-L	FAZ-D5/4-NA-L
6	FAZ-D6/1-NA-L	FAZ-D6/2-NA-L	FAZ-D6/3-NA-L	FAZ-D6/4-NA-L
7	FAZ-D7/1-NA-L	FAZ-D7/2-NA-L	FAZ-D7/3-NA-L	FAZ-D7/4-NA-L
8	FAZ-D8/1-NA-L	FAZ-D8/2-NA-L	FAZ-D8/3-NA-L	FAZ-D8/4-NA-L
10	FAZ-D10/1-NA-L	FAZ-D10/2-NA-L	FAZ-D10/3-NA-L	FAZ-D10/4-NA-L
13	FAZ-D13/1-NA-L	FAZ-D13/2-NA-L	FAZ-D13/3-NA-L	FAZ-D13/4-NA-L
15	FAZ-D15/1-NA-L	FAZ-D15/2-NA-L	FAZ-D15/3-NA-L	FAZ-D15/4-NA-L
16	FAZ-D16/1-NA-L	FAZ-D16/2-NA-L	FAZ-D16/3-NA-L	FAZ-D16/4-NA-L
20	FAZ-D20/1-NA-L	FAZ-D20/2-NA-L	FAZ-D20/3-NA-L	FAZ-D20/4-NA-L
25	FAZ-D25/1-NA-L	FAZ-D25/2-NA-L	FAZ-D25/3-NA-L	FAZ-D25/4-NA-L
30	FAZ-D30/1-NA-L	FAZ-D30/2-NA-L	FAZ-D30/3-NA-L	FAZ-D30/4-NA-L
32	FAZ-D32/1-NA-L	FAZ-D32/2-NA-L	FAZ-D32/3-NA-L	FAZ-D32/4-NA-L
35 ②	FAZ-D35/1-NA-SP	FAZ-D35/2-NA	FAZ-D35/3-NA	FAZ-D35/4-NA
40 ②	FAZ-D40/1-NA-SP	FAZ-D40/2-NA	FAZ-D40/3-NA	FAZ-D40/4-NA

Notes

① Two-piece order. Quantities of two per box.

② 35A and 40A at 240 Vac were available prior to the creation of the FAZ-NA-L offering so the catalog numbers at these amperages exclude the "L" suffix.

FAZ-NA-L UL 489 Circuit Breakers at 240 Vac—10 kAIC D Curve

- UL approved (UL 489) and CSA Certified (CSA C22.2 No. 5-02) as branch circuit breakers
- Interrupting capacity: 10 kA UL/CSA; 15 kA IEC 60947-2
- 48 Vdc for single-pole
- Current limiting device
- UL file number E235139

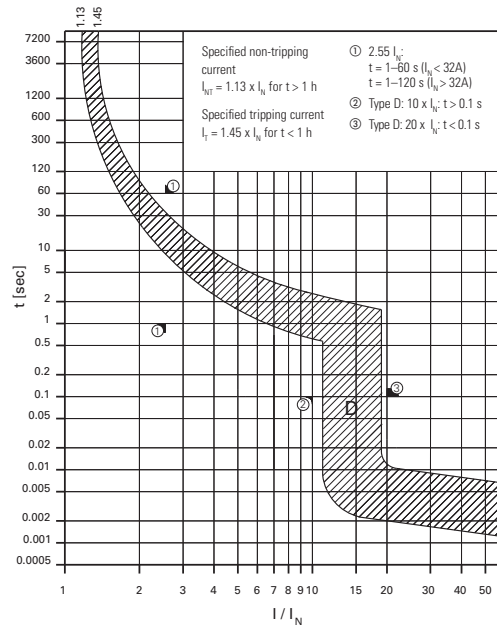

Single-Pole



Two-Pole



Three-Pole



Four-Pole



FAZ-RT-L UL 489 Circuit Breakers with Ring-Tongue Terminals at 240 Vac— 10 kAIC, 14 kAIC D Curve (13–20A)



Amps	Single-Pole ① Catalog Number	Two-Pole Catalog Number	Three-Pole Catalog Number	Four-Pole Catalog Number
D Curve with Ring-Tongue Terminals (10–20X I_n Current Rating)				
0.5	FAZ-D0.5/1-RT-L	FAZ-D0.5/2-RT-L	FAZ-D0.5/3-RT-L	FAZ-D0.5/4-RT-L
1	FAZ-D1/1-RT-L	FAZ-D1/2-RT-L	FAZ-D1/3-RT-L	FAZ-D1/4-RT-L
1.5	FAZ-D1.5/1-RT-L	FAZ-D1.5/2-RT-L	FAZ-D1.5/3-RT-L	FAZ-D1.5/4-RT-L
2	FAZ-D2/1-RT-L	FAZ-D2/2-RT-L	FAZ-D2/3-RT-L	FAZ-D2/4-RT-L
3	FAZ-D3/1-RT-L	FAZ-D3/2-RT-L	FAZ-D3/3-RT-L	FAZ-D3/4-RT-L
4	FAZ-D4/1-RT-L	FAZ-D4/2-RT-L	FAZ-D4/3-RT-L	FAZ-D4/4-RT-L
5	FAZ-D5/1-RT-L	FAZ-D5/2-RT-L	FAZ-D5/3-RT-L	FAZ-D5/4-RT-L
6	FAZ-D6/1-RT-L	FAZ-D6/2-RT-L	FAZ-D6/3-RT-L	FAZ-D6/4-RT-L
7	FAZ-D7/1-RT-L	FAZ-D7/2-RT-L	FAZ-D7/3-RT-L	FAZ-D7/4-RT-L
8	FAZ-D8/1-RT-L	FAZ-D8/2-RT-L	FAZ-D8/3-RT-L	FAZ-D8/4-RT-L
10	FAZ-D10/1-RT-L	FAZ-D10/2-RT-L	FAZ-D10/3-RT-L	FAZ-D10/4-RT-L
13	FAZ-D13/1-RT-L	FAZ-D13/2-RT-L	FAZ-D13/3-RT-L	FAZ-D13/4-RT-L
15	FAZ-D15/1-RT-L	FAZ-D15/2-RT-L	FAZ-D15/3-RT-L	FAZ-D15/4-RT-L
16	FAZ-D16/1-RT-L	FAZ-D16/2-RT-L	FAZ-D16/3-RT-L	FAZ-D16/4-RT-L
20	FAZ-D20/1-RT-L	FAZ-D20/2-RT-L	FAZ-D20/3-RT-L	FAZ-D20/4-RT-L
25	FAZ-D25/1-RT-L	FAZ-D25/2-RT-L	FAZ-D25/3-RT-L	FAZ-D25/4-RT-L
30	FAZ-D30/1-RT-L	FAZ-D30/2-RT-L	FAZ-D30/3-RT-L	FAZ-D30/4-RT-L
32	FAZ-D32/1-RT-L	FAZ-D32/2-RT-L	FAZ-D32/3-RT-L	FAZ-D32/4-RT-L
35 ②	FAZ-D35/1-RT-SP	FAZ-D35/2-RT	FAZ-D35/3-RT	FAZ-D35/4-RT
40 ②	FAZ-D40/1-RT-SP	FAZ-D40/2-RT	FAZ-D40/3-RT	FAZ-D40/4-RT

Notes



- ① Two-piece order. Quantities of two per box.
- ② 35A and 40A at 240 Vac were available prior to the creation of the FAZ-NA-L offering so the catalog numbers at these amperages exclude the "L" suffix.

Accessories

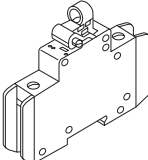
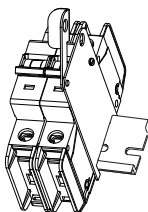
FAZ-NA and FAZ-NA-L UL 489 Breakers

	Description	Catalog Number
Contact	Two-pole contact or auxiliary contact/trip indicating contact	Z-NHK ①
		
Auxiliary Contact	Auxiliary contact	Z-IHK-NA
		
Shunt Trip	Shunt trip 110–415 Vac Shunt trip 12–110 Vac	FAZ-XAA-NA110-415VAC FAZ-XAA-NA12-110VAC
		
Padlock Hasp	Padlock hasp	Z-IS/SPE-1TE
		
Lockoff Device	UL lockoff device	FAZPLOFF
		

FAZ-NA and FAZ-NA-L UL 489 Breakers, continued

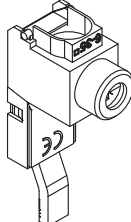
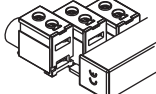
	Description	Catalog Number
Busbar	Busbar—single-pole, 6 terminals ②③④⑤	Z-SV/UL-16/1P-1TE/6
	Busbar—single-pole, 12 terminals ②③④⑤	Z-SV/UL-16/1P-1TE/12
	Busbar—single-pole, 18 terminals ②③④⑤	Z-SV/UL-16/1P-1TE/18
	Busbar—two-pole, 6 terminals ②③④⑤	Z-SV/UL-16/2P-2TE/6
	Busbar—two-pole, 12 terminals ②③④⑤	Z-SV/UL-16/2P-2TE/12
	Busbar—two-pole, 18 terminals ②③④⑤	Z-SV/UL-16/2P-2TE/18
	Busbar—three-pole, 6 terminals ②③④⑤	Z-SV/UL-16/3P-3TE/6
	Busbar—three-pole, 12 terminals ②③④⑤	Z-SV/UL-16/3P-3TE/12
	Busbar—three-pole, 18 terminals ②③④⑤	Z-SV/UL-16/3P-3TE/18
Busbar Shroud	Three-pole busbar shroud	ZV-BS-UL
		
Extension Terminal	Extension terminal— 35 mm ² (10–1/0 AWG)	Z-EK/35/UL
		
Bus Connector	Bus connector—conductors up to 50 mm ² (–1/0 AWG)	Z-EB/50/UL
		

Notes

- ① Voltage of FAZ-NA circuit breaker is limited to 300V with this auxiliary contact installed.
- ② Do not cut commoning link.
- ③ A maximum of three commoning links may be used in conjunction. Each breaker connected to the commoning link must have the same number of poles for proper use.
- ④ Not for use with ring-tongue circuit breakers.
- ⑤ Bus may be center fed for high current capacity.

Tripping Signal Switch Z-NHK, Z-IHK-NA

- Design according to IEC/EN 60947-5-1, IEC/EN 62019
- Field installable
- The specified minimum voltages are per contact—take into account particularly in case of series connection
- Self-cleaning contacts
- Contact material and design particularly suitable for extra low voltage
- Z-NHK: the function of one of the two change-over contacts can be switched from “auxiliary switch” to “tripping signal switch”
- Tripping signal contact transmits message of electric tripping, not mechanical switch-off
- Test key for contact function “electrical tripping”
- Z-IHK-NA: will allow for > 480Y/277 Vac rating

Connection Diagram

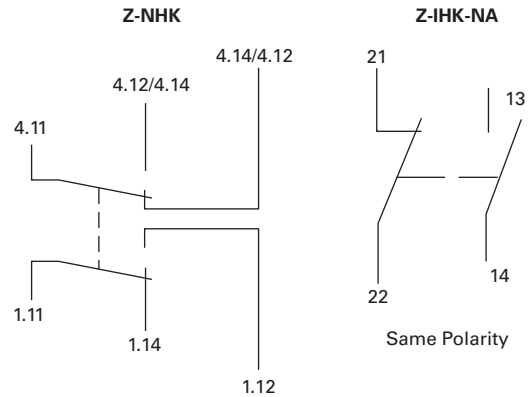

Busbar Connection Example

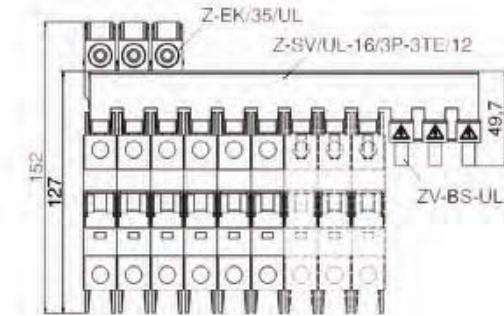

1

Z-NHK



Z-IHK-NA



Contact and Auxiliary Contact

Description	Z-NHK	Z-IHK-NA
Electrical		
Contact function	2CO	1NO + 1NC
Rated voltage	230V	250V
Frequency	50/60 Hz	50/60 Hz
Rated current	2A	6A
Rated thermal current I_{th}	2A	6A
Utilization category AC13 Rated operational current I_b	3A/250 Vac	3A/250 Vac
Utilization category AC15 Rated operational current I_b	2A/250 Vac	2A/250 Vac
Utilization category DC12 Rated operational current I_b	0.5A/110 Vdc	0.5A/110 Vdc 0.25A/220 Vdc
Rated insulation voltage U_i	250 Vac	250 Vac
Minimum operational voltage per contact U_{min}	5 Vdc	5 Vdc
Minimum operational current I_{min}	10 mA DC	10 mA AC/DC
Rated peak withstand voltage U_{imp} (1.2/50 μ)	2.5 kV	4 kV
Conditional short-circuit current I_k with backup fuse 6A	1 kA	1 kA
Max. backup fuse, overload and short circuit	6A gL	—
Mechanical		
Tripping indicator "electrical tripping"	Blue/white	—
Frame size	45 mm	45 mm
Device height	80 mm	80 mm
Device width	8.8 mm (0.5MU)	8.8 mm (0.5MU)
Mounting	Onto switching device	—
Degree of protection, built-in	IP40	IP40
Terminal protection	Finger and hand touch safe According to BGV A3, ÖVE-EN 6	Finger and hand touch safe According to BGV A3, ÖVE-EN 6
Terminals	Lift terminals	Lift terminals
Terminal capacity	20–14 AWG	0.5–2.5 mm ²
Terminal screws	M3 (Posidrive Z0)	M3 (Posidrive Z0)
Fastening torque of terminal screws	7 lb-in	Max. 1.2 Nm

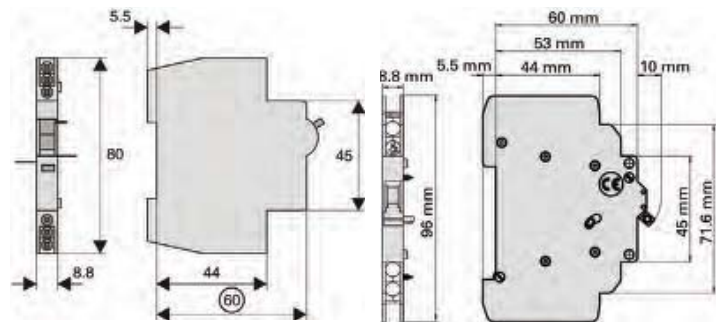

Shunt trip release FAZ-XAA-NA

- Remote release for subsequent mounting onto FAZ-NA/RT
- Additional installation of standard auxiliary switch is possible
- Position indicator red–green

Connection Diagram

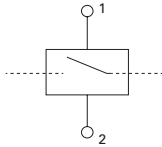

Shunt Trip Release FAZ-XAA-NA

Description	FAZ-XAA-NA12-110VAC	FAZ-XAA-NA110-415VAC
Electrical		
Can be mounted onto	FAZ-NA / FAZ-NA-DC / FAZ-RT	FAZ-NA / FAZ-NA-DC / FAZ-RT
Operational voltage range	12–110 Vac 12–60 Vdc	110–415 Vac 110–230 Vdc
Frequency	50/60 Hz	50/60 Hz
Mechanical		
Frame size	45 mm	45 mm
Device height	105 mm	105 mm
Device width	17.5 mm	17.5 mm
Mounting	Quick fastening with two lock-in positions on EN 50022	
Degree of protection, built-in	IP40	IP40
Terminal protection	Finger and hand touch safe according to BGV A3, ÖVE-EN 6	
Terminals	Open mouthed/lift	Open mouthed/lift
Terminal capacity One and two wires	18–10 AWG	18–10 AWG

Busbar block UL 489 (pin)

- Tested according to UL 489
- Do not cut
- Extension terminal 35 mm² Z-EK/35/UL for copper conductors
- Incoming terminal 50 mm² Z-EB/50/UL
- For covering of not used pins, use busbar tag shrouds ZV-BS-UL

Connection Diagrams

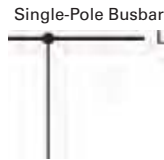
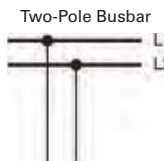
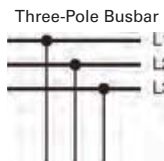

Busbar Block UL 489 (Pin)

Description	UL 489	IEC/EN 60947-2
Electrical		
Rated operational voltage	480/277 Vac 96 Vdc	—
Rated frequency	50/60 Hz	—
Rated voltage	480 Vac	690 Vac
Overvoltage category	—	III
Rated impulse withstand voltage U_{imp}	—	9.5 kV
Rated current	80A at 40°C	80A at 30°C
Rated conditional short-circuit current AC with 350A gG	—	15 kA
Short-circuit current	10 kA	—
Mechanical		
Busbar cross section	—	16 mm ² Cu
Flame class according to UL 94	V0	—
Pollution degree	—	2
Comparative tracking index	—	CTI 600
Minimum clearance (internal/external)	—	> 9.5/25.4 mm
Minimum creepage distance (internal/external)	—	> 12.7/50.8 mm
Resistance to climatic conditions	—	According to DIN/EN 60068

1

Technical Data and Specifications

Trip Curve Chart

Eaton FAZ-NA and FAZ-NA-L branch circuit breakers are available with "B," "C" and "D" tripping characteristics. B-curve devices are suitable for applications where low levels of inrush current are expected.

C-curve devices are suitable for applications where medium levels of inrush current are expected. Applications include small transformers, lighting, pilot devices, control circuits and coils. C-curve devices provide a medium magnetic trip point.

D-curve devices are suitable for applications where high levels of inrush current are expected. The high magnetic trip point prevents nuisance tripping in high inductive applications such as motors, transformers and power supplies.

Eaton FAZ-NA and FAZ-NA-L devices are current limiting, which means they interrupt fault currents within one half cycle of the fault. Current limiting devices offer superior protection by reducing peak let-through current and energy.

Tripping Characteristics

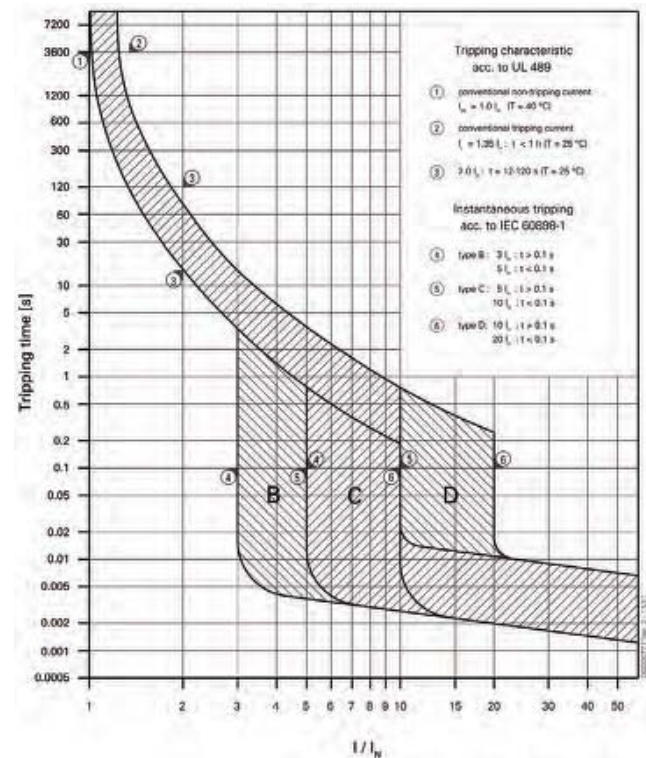

Connection Diagrams

Single-Pole



Two-Pole

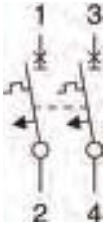

Three-Pole

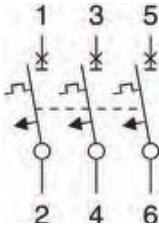

UL 489 Miniature Circuit Breakers Technical Data

Description	FAZ-NA	FAZ-NA-DC	FAZ-NA-L	
Electrical				
Design according to	UL 489, CSA C22.2 No.5, IEC 60947-2	UL 489, CSA C22.2 No.5, IEC 60947-2	UL 489, CSA C22.2 No.5, IEC 60947-2	
Rated voltage	Single-pole: 277 Vac 2-, 3- or 4-pole: 277/480 Vac	125 Vdc per pole 250 Vdc with 2-poles in connected series	Single-pole: 240 Vac 2-, 3- or 4-pole: 240 Vac	
	Single-pole: 48 Vdc per pole 2-pole in series: 96 Vdc	—	Single-pole: 48 Vdc per pole 2-pole in series: 96 Vdc	
Rated current	B: 1–32 A C & D: 0.5–32 A	C: 2–40 A	B: 1–63 A C: 0.5–63 A D: 0.5–40 A	
Characteristic	B, C, D	C	B, C, D	
Current interrupting rating	B curve—10 kA: 1–13 A, 30–32 A C curve—10 kA: 0.5–13 A, 30–32 A B & C curve—14 kA: 15–25 A D curve—10 kA: 0.5–10 A, 25–32 A D curve—14 kA: 13–20 A	10 kA	B curve—10 kA: 1–13 A, 30–32 A C curve—10 kA: 0.5–13 A, 30–32 A B & C curve—14 kA: 15–25 A D curve—10 kA: 0.5–10 A, 25–32 A D curve—14 kA: 13–20 A	
	Rated frequency	50/60 Hz	50/60 Hz	50/60 Hz
	Endurance	≥ 20,000 operations	≥ 20,000 operations	≥ 20,000 operations
	Line voltage connection	Suitable for reverse feed	Suitable for reverse feed	Suitable for reverse feed
	Mechanical			
Frame size	45 mm	45 mm	45 mm	
Device height	105 mm	105 mm	105 mm	
Device width	17.7 mm per pole	17.7 mm per pole	17.7 mm per pole	
Terminal protection	Finger and hand touch safe according to BGV A3, OVE-EN 6	Finger and hand touch safe according to BGV A3, OVE-EN 6	Finger and hand touch safe according to BGV A3, OVE-EN 6	
Mounting	Quick fastening with two lock-in positions on IEC/EN 60715	Quick fastening with two lock-in positions on IEC/EN 60715	Quick fastening with two lock-in positions on IEC/EN 60715	
Upper and lower terminals	Open mouth/lift terminals	Open mouth/lift terminals	Open mouth/lift terminals	
Terminal capacity	One wire: AWG 18–6 Two wires: AWG 18–10	One wire: AWG 18–6 Two wires: AWG 18–10	One wire: AWG 18–6 Two wires: AWG 18–10	
Terminal fastening torque	AWG 18–21: 21 lb-in AWG 10–8: 25 lb-in AWG 6: 36 lb-in	AWG 18–21: 21 lb-in AWG 10–8: 25 lb-in AWG 6: 36 lb-in	AWG 18–21: 21 lb-in AWG 10–8: 25 lb-in AWG 6: 36 lb-in	
Mounting	Independent of position	Independent of position	Independent of position	
Calibration temperature	UL 489, CSA C22.2 No.5	40°C	40°C	
	IEC 60947-2	30°C	30°C	

1.2

Miniature Circuit Breakers and Supplementary Protectors

UL 489 DIN Rail Miniature Circuit Breakers

1

Power Loss at I_n

I_n [A]	Characteristic B			Characteristic C			Characteristic D		
	Single-Pole P [W]	Two-Pole P [W]	Three-Pole P [W]	Single-Pole P [W]	Two-Pole P [W]	Three-Pole P [W]	Single-Pole P [W]	Two-Pole P [W]	Three-Pole P [W]
0.5	—	—	—	1.6	3.2	4.7	1.6	3.2	4.8
1.0	1.1	2.2	3.4	1.1	2.2	3.4	0.8	1.5	2.3
1.5	2.2	4.4	6.6	1.3	2.6	3.9	1.0	2.1	3.1
2.0	1.4	2.8	4.3	1.4	2.8	4.3	1.0	2.1	3.1
3.0	2.1	4.2	6.4	1.2	2.4	3.6	1.2	2.4	3.6
4.0	1.4	2.9	4.3	1.4	2.9	4.3	1.4	2.9	4.3
5.0	1.8	3.7	5.5	1.9	3.7	5.6	1.5	2.9	4.4
6.0	1.7	3.5	5.2	1.2	2.3	3.5	1.2	2.3	3.5
7.0	2.0	4.0	6.0	1.4	2.8	4.3	1.4	2.8	4.3
8.0	2.0	3.9	5.9	1.4	2.8	4.2	1.2	2.4	3.7
10.0	1.8	3.6	5.3	1.8	3.6	5.3	1.5	3.0	4.5
13.0	2.4	4.7	7.1	2.4	4.7	7.1	2.0	4.1	6.1
15.0	1.9	3.8	5.6	1.9	3.8	5.6	1.5	3.1	4.6
16.0	2.1	4.3	6.4	2.1	4.3	6.4	1.7	3.5	5.2
20.0	2.9	5.8	8.7	2.9	5.8	8.7	1.8	3.7	5.5
25.0	3.1	6.2	9.3	3.1	6.2	9.3	2.6	5.1	7.7
30.0	3.0	6.0	9.0	3.0	6.0	9.0	2.7	5.4	8.1
32.0	3.4	6.8	10.2	3.4	6.8	10.2	3.1	6.2	9.3
35.0	4.0	8.1	12.1	3.7	7.4	11.0	3.8	7.6	11.3
40.0	4.0	8.1	12.1	4.0	8.1	12.1	3.9	7.8	11.6

Let-Through Energy

Characteristic B (1–32A), 277V

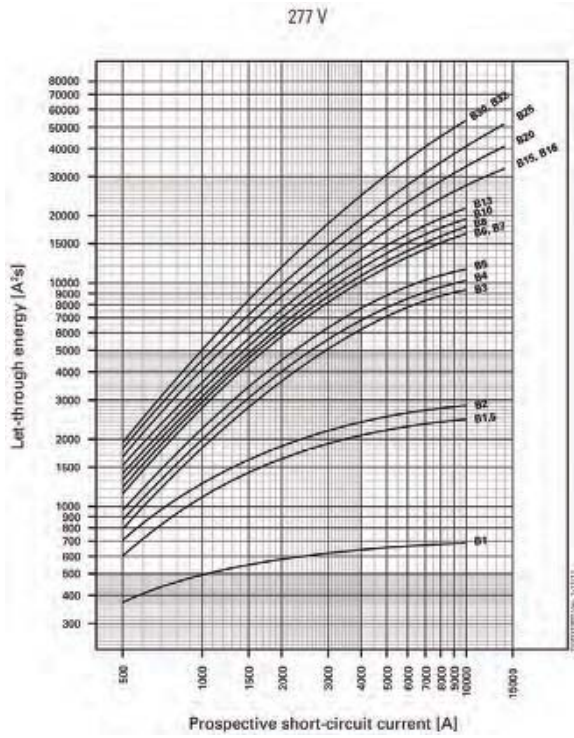

Characteristic B (35–63A), 240V

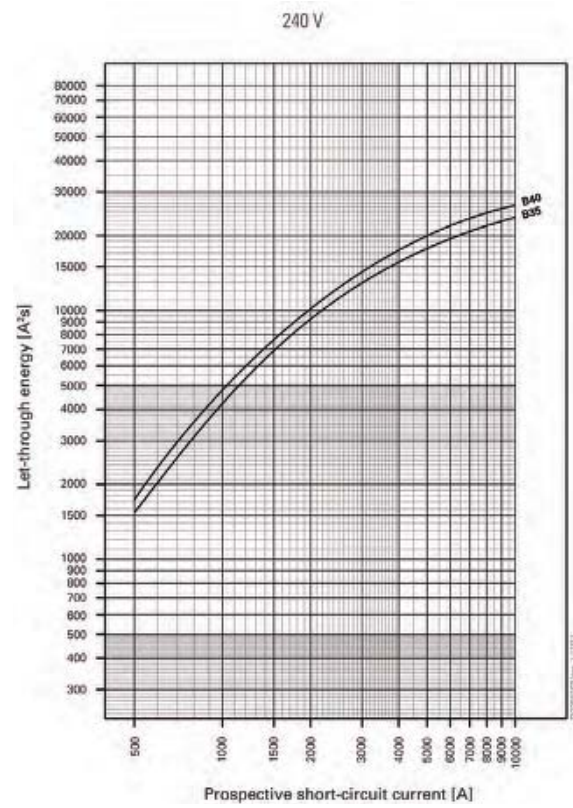

Characteristic C (0.5–32A), 277V

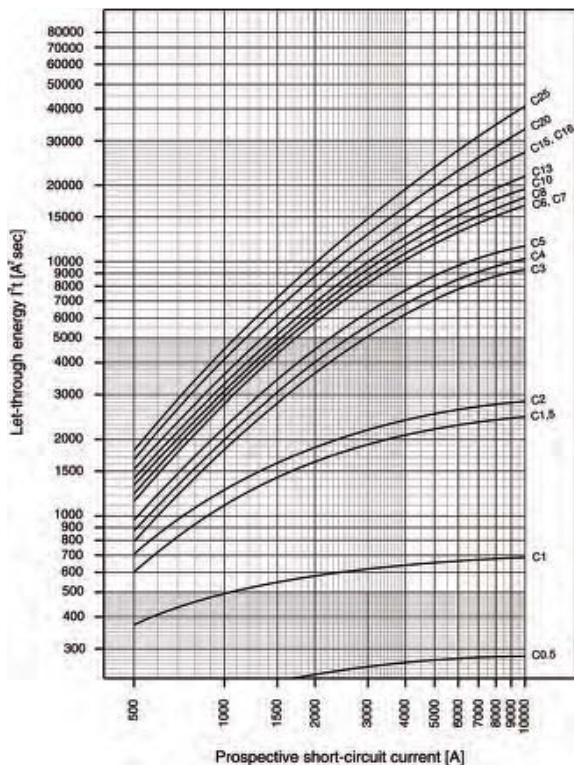

Characteristic C (35–63A), 240V

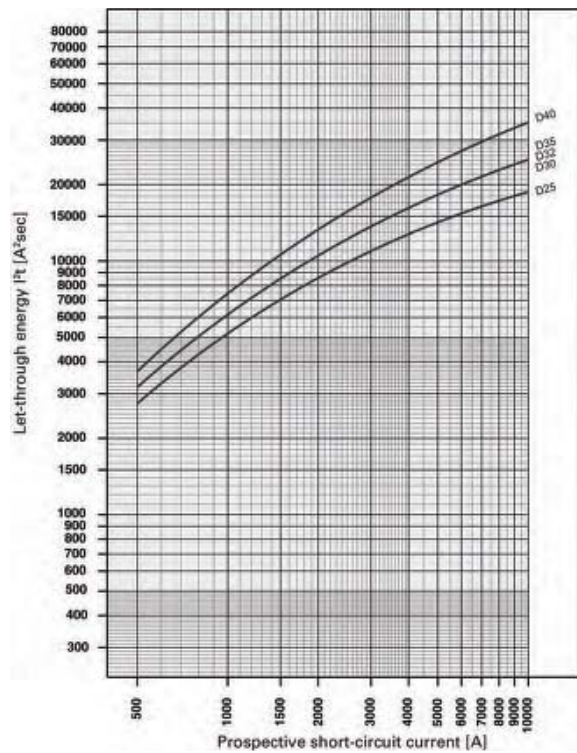

1.2

Miniature Circuit Breakers and Supplementary Protectors

UL 489 DIN Rail Miniature Circuit Breakers

1

Characteristic D (0.5–32A), 277V

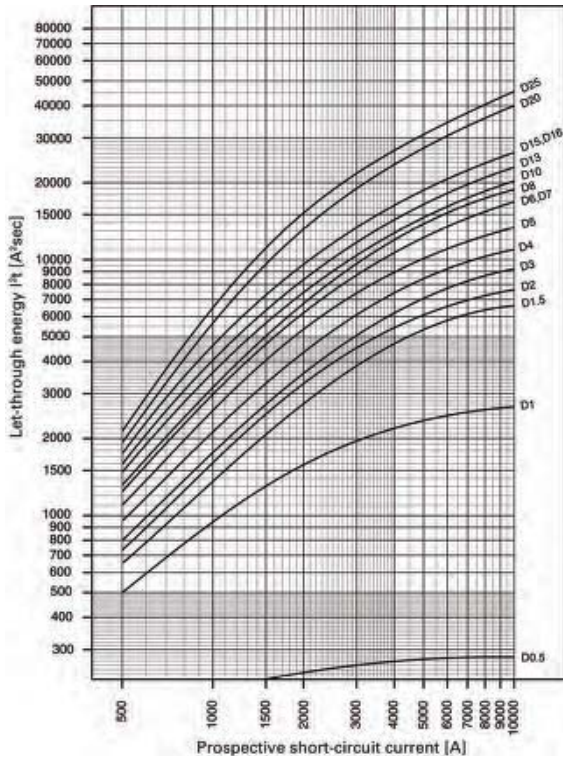

Characteristic D (35–63A), 240V

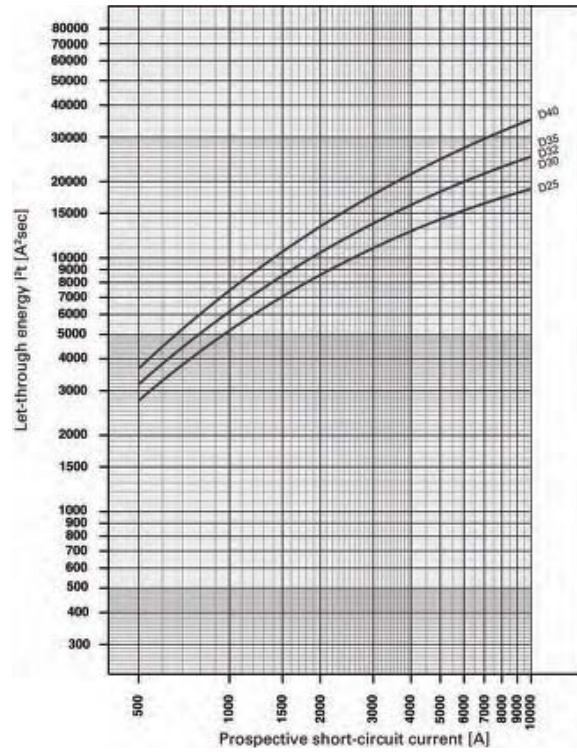

Influence of Ambient Temperature T on Load Carrying Capacity

Device Market Current Rating I_n (A) at 40°C	I_n (A) at Higher Ambient Temperature							
	15°C	20°C	25°C	30°C	40°C	50°C	55°C	60°C
0.5	0.6	0.5	0.5	0.5	0.5	0.5	0.5	0.5
1.0	1.1	1.1	1.1	1.0	1.0	1.0	0.9	0.9
1.5	1.7	1.6	1.6	1.6	1.5	1.4	1.4	1.4
2.0	2.2	2.2	2.1	2.1	2.0	1.9	1.9	1.8
3.0	3.3	3.2	3.2	3.1	3.0	2.9	2.9	2.8
4.0	4.4	4.3	4.2	4.2	4.0	3.8	3.8	3.7
5.0	5.5	5.4	5.3	5.2	5.0	4.8	4.7	4.6
6.0	6.6	6.5	6.4	6.2	6.0	5.8	5.6	5.5
7.0	7.7	7.6	7.4	7.3	7.0	6.7	6.6	6.4
8.0	8.8	8.6	8.5	8.3	8.0	7.7	7.5	7.4
10.0	11.0	10.8	10.6	10.4	10.0	9.6	9.4	9.2
13.0	14.3	14.0	13.8	13.5	13.0	12.5	12.5	12.0
15.0	16.5	16.2	15.9	15.6	15.0	14.4	14.1	13.8
16.0	17.6	17.3	17.0	16.6	16.0	15.4	15.0	14.7
20.0	22.0	21.6	21.2	20.8	20.0	19.2	18.8	18.4
25.0	27.5	27.0	26.5	26.0	25.0	24.0	23.3	23.0
30.0	33.0	32.4	31.8	31.2	30.0	28.8	28.2	27.6
32.0	35.2	34.6	33.9	33.3	32.0	30.7	30.1	29.4
40.0	44.0	43.2	42.4	41.6	40.0	38.4	37.6	36.8

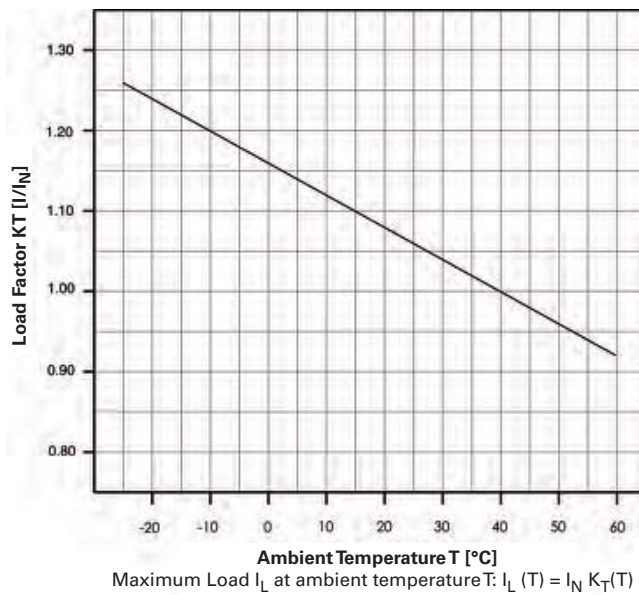

Load Carrying Capacity of Adjoining Miniature Circuit Breakers

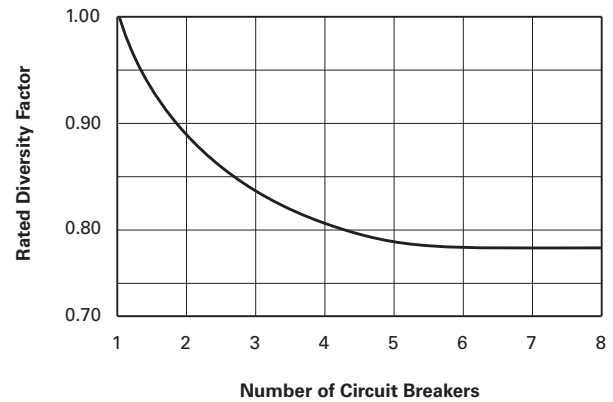

1.2

Miniature Circuit Breakers and Supplementary Protectors

UL 489 DIN Rail Miniature Circuit Breakers

1

Dimensions

Approximate Dimensions in Inches (mm)

Miniature Circuit Breakers

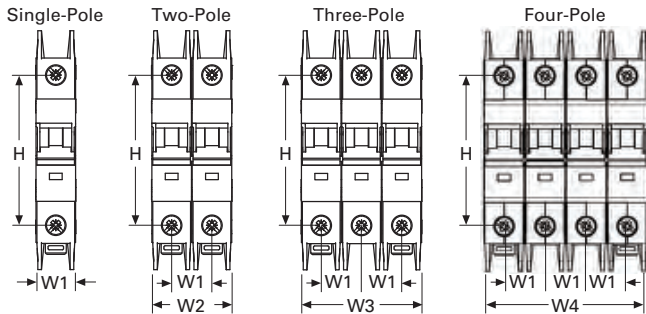

H	W1	W2	W3	W4
4.13 (105.0)	0.70 (17.7)	1.39 (35.3)	2.09 (53.1)	2.79 (70.8)

Lockout Attachment—Z-IS/SPE-1TE

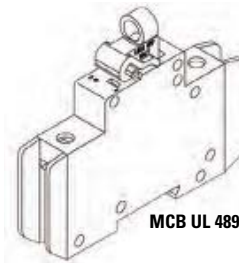

UL Lockoff Device—FAZPLOFF

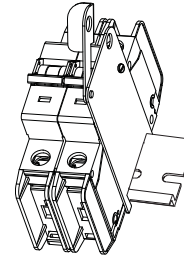

Accessories

Z-SV/UL-16/6

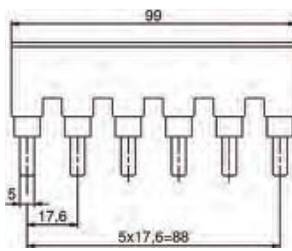

Z-SV/UL-18...12

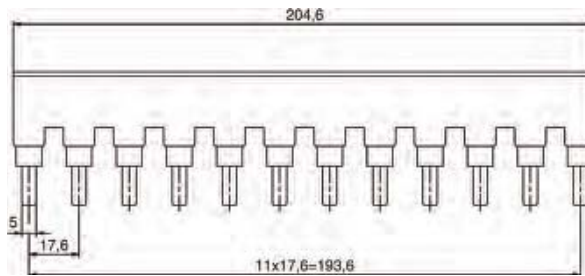

ZV-BS-UL

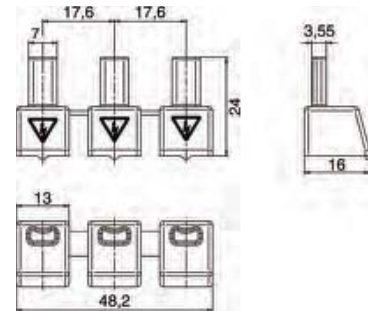

Z-SV/UL-16.../18

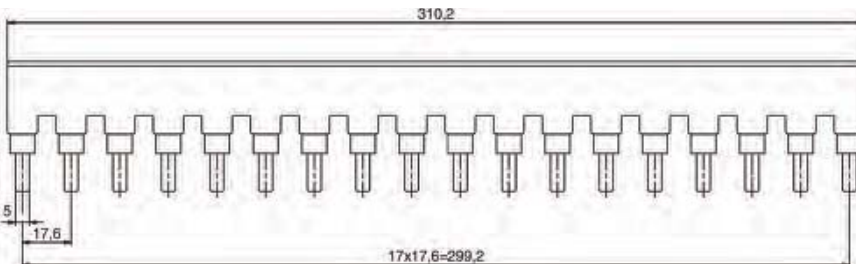

Z-EK/35/UL

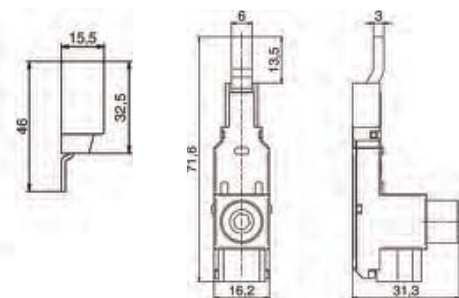

Z-EK/35/UL

Description	UL 489	IEC/EN 60947-2
U_e	480 Vac/96 Vdc	240/415 Vac
f	50/60 Hz	50/60 Hz
U_{imp}	—	9.5 kV
I_e	80A at 40°C	80A at 30°C
	10–1/0 AWG 60/75°C Cu	2.5–35 mm ² Cu
	0.56 in	14 mm

Z-EB/50/UL

Description	UL 489	IEC/EN 60947-2
U_e	480 Vac/96 Vdc	240/415 Vac
f	50/60 Hz	50/60 Hz
U_{imp}	—	9.5 kV
I_e	115A at 40°C	160A at 30°C
	#1–14 AWG 60/75°C Cu	1.5–50 mm ² Cu
	0.56 in	14 mm

Application Guidelines

Example of UL 489 and UL 1077 Application

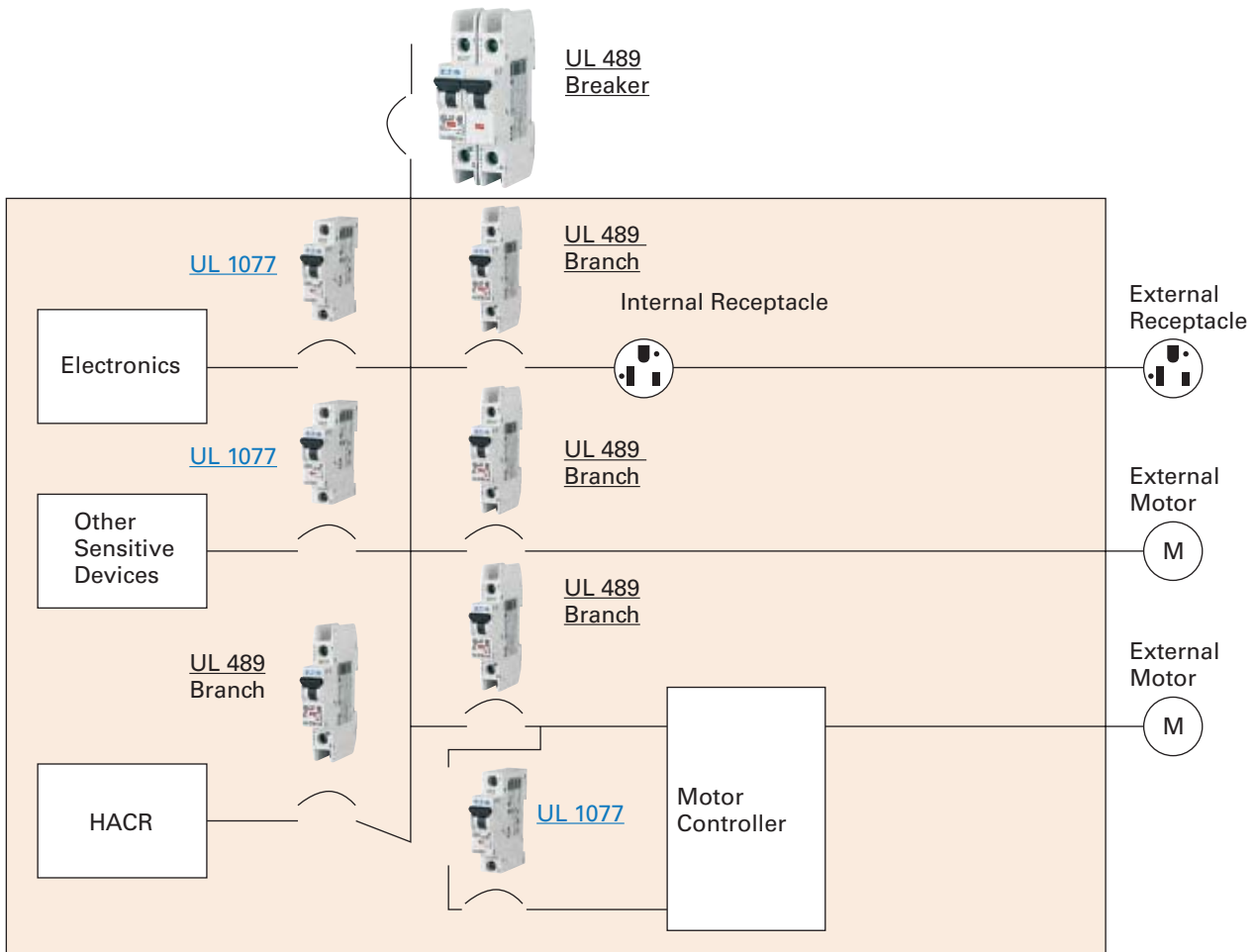

Example of UL 489 and UL 1077 Application

UL 489 circuit breakers

Used for branch circuit protection, internal/external receptacles, external motors and HACR equipment (heating, air conditioning and refrigeration).

UL 1077 supplementary protectors

Used for overcurrent protection within appliances or electrical equipment, where branch circuit protection is already provided or not required.

Note: UL 489 devices can be used in place of UL 1077; UL 1077 devices cannot be used in place of UL 489.