

SHARKBITE

THE MARK OF QUALITY

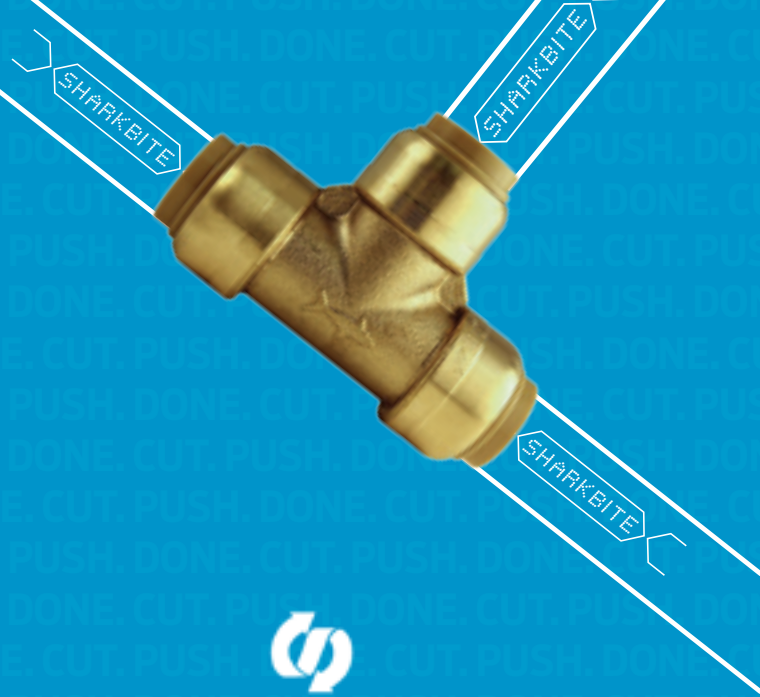

LEAD-FREE/SAFETY*

All SharkBite® fittings are made of Lead Free DZR brass and exceed ASSE 1061 Section IV, 4.1 Materials-Dezincification (DZR)-ISO 6509 standards.

**Reference Page 26 for additional information.*



VERSATILE

SharkBite fittings have the versatility to transition from Copper, PEX, CPVC, PE-RT, HDPE, Polybutylene and PVC.



PROVEN AND GUARANTEED

SharkBite's quality and performance is field-proven with more than 550 million connections. SharkBite owns the entire manufacturing process, from raw brass to finished product, making SharkBite the only push-to-connect brand that can ensure a clean, leak-free connection.



NO TOOLS

No glue, solder, clamps or unions required when using SharkBite fittings, providing a quick and efficient application that saves installers time, labor, and money.



FLEXIBILITY

SharkBite fittings can be rotated even after assembly allowing for easier installation in tight places.



BEHIND-THE-WALL

SharkBite fittings are approved to be used underground and behind walls without access panels.

CERTIFICATIONS

- Fittings are certified to 200 °F (93 °C) max and 200 psi max
- Design certified to NSF/ANSI 61 and ASSE 1061 product standard for use in potable water and hydronic heating water distribution

TABLE OF CONTENTS

SECTION 1: THE SHARKBITE CONNECTION SYSTEM	3
1-A: Core Fittings	3
1-B: Radiant Fittings	7
1-C: Transition Fittings	7
1-D: Fire Fittings	8
1-E: Flex Hoses	8
1-F: Stops & Fixture Supply Fittings	9
1-G: Additional Products	10
1-H: Kits	11
1-I: Tools	12
SECTION 2: SHARKBITE VALVES	13
2-A: Pressure Regulating Valves	13
2-B: Thermostatic Mixing Valves	13
2-C: Ball Valves	14
2-D: PVC Ball Valves	14
2-E: Check Valves	14
2-F: Temperature & Pressure Relief Valves	15
2-G: General Supply Valves	15
SECTION 3: SHARKBITE PEX BARB FITTINGS	15
3-A: PEX Barb Core Fittings	15
3-B: PEX Barb Transition Fittings	18
3-C: PEX Barb Poly Alloy Fittings	18
3-D: PEX Barb Fire Fittings	19
3-E: PEX Barb Stop & Fixture Supply Fittings	20
3-F: PEX Barb Additional Products	20
3-G: PEX Barb Accessories	21
3-H: PEX Barb Tools	22
BENEFITS OF SHARKBITE PEX	23
MADE IN THE USA	24
SECTION 4: SHARKBITE PEX PIPE	25
4-A: Potable Water PEX Pipe	25
4-B: Special Application PEX Pipe	26
LIMITED WARRANTY	28



VISIT US ONLINE OR ON THE GO
www.sharkbite.com

SHARKBITE

CONNECTION SYSTEM

REDEFINING EFFICIENCY

For more than 20 years and with over 250 million fittings installed, SharkBite has been at the forefront of innovating solutions for helping the plumbing trade improve efficiency with enhanced jobsite performance. Being a leader through continuous innovation and providing solutions that address the challenges that plumbing professionals face every day is who we are. Whether you are repairing a water line, installing a water heater, remodeling a home or plumbing a system in a new construction job, SharkBite provides proven solutions that save time, reduce cost, and have the versatility to overcome the most difficult situations.

TOTAL SYSTEM

The SharkBite system includes a wide range of plumbing fittings, valves, PEX pipe, outlet boxes and other plumbing accessories, making it the only system that is a total end-to-end plumbing solution from meter to fixture. This means compatibility and peace of mind quality that is backed by a single manufacturer.

www.sharkbite.com

All SharkBite fittings are made of Lead Free DZR brass and exceed ASSE 1061 Section 1V, 4.1 Materials-Dezincification (DZR) - ISO 6509 standards.



PRODUCT DESCRIPTION		PART NUMBER	QTY/BAG
SECTION 1: THE SHARKBITE CONNECTION SYSTEM			
1-A: CORE FITTINGS			
COUPLINGS			
1/4" (3/8" OD) X 1/4" (3/8" OD)		U004LF	6
3/8" (1/2" OD) X 3/8" (1/2" OD)		U006LF	6
1/2" X 1/2"		U008LF	12
3/4" X 3/4"		U016LF	12
1" X 1"		U020LF	6
LARGE DIAMETER	1-1/4" X 1-1/4" (For PEX applications, stiffeners are sold separately)	SB0135	1
	1-1/2" X 1-1/2" (For PEX applications, stiffeners are sold separately)	SB0141	1
	2" X 2" (For PEX applications, stiffeners are sold separately)	SB0154	1
REDUCING COUPLINGS			
1/4" (3/8" OD) X 1/2"		U050LF	6
3/8" (1/2" OD) X 1/2"		U009LF	6
3/4" X 1/2"		U058LF	12
1" X 3/4"		U060LF	6
LARGE DIAMETER	1-1/4" X 1" (For PEX applications, stiffeners are sold separately)	SB013528	1
	1-1/2" X 1" (For PEX applications, stiffeners are sold separately)	SB014128	1
	1-1/2" X 1-1/4" (For PEX applications, stiffeners are sold separately)	SB014135	1
	2" X 1-1/2" (For PEX applications, stiffeners are sold separately)	SB015441	1
SLIP FITTINGS			
SharkBite slip couplings and tees are ideal for repairing and tapping into existing rigid pipe lines. The slip feature ensures the pipe is fully engaged into the fitting when the pipe is in a fixed position. The slip end is only suitable for use with Copper and CPVC pipe.			
SLIP COUPLINGS (SLIP END ONLY SUITABLE FOR COPPER AND CPVC)			
Slip couplings are the most efficient way to repair a burst pipe or leak. Slip fittings simply repair by doing the job that two couplings and extra pipe used to do. Only one end of the coupling has a stop, allowing the opposite end to slide freely over the end of a pipe. The fittings can then be released with a disconnect tool and slid back onto the other end of the pipe for a successful connection and leak repair.			
1/2" X 1/2"		U3008LF	3
3/4" X 3/4"		U3016LF	3
1" X 1"		U3020LF	1
LARGE DIAMETER	1-1/4" X 1-1/4" (For PEX applications, stiffeners are sold separately)	SB0635	1
	1-1/2" X 1-1/2" (For PEX applications, stiffeners are sold separately)	SB0641	1
	2" X 2" (For PEX applications, stiffeners are sold separately)	SB0654	1
FEMALE CONNECTORS			
1/4" (3/8" OD) X 1/2" FNPT Reducing		U066LF	6
3/8" (1/2" OD) X 1/2" FNPT Reducing		U070LF	6
1/2" X 1/2" FNPT Straight		U072LF	12



SECTION 1: THE SHARKBITE CONNECTION SYSTEM

HOW TO INSTALL SHARKBITE PUSH-TO-CONNECT PRODUCTS



CUT:
Cut the pipe square removing rough edges and debris. Mark the pipe to the correct insertion depth.

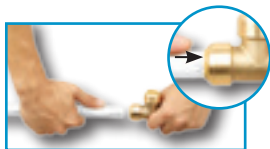

PUSH
Push pipe and fitting together up to the depth mark.



DONE.



Using the disconnect clip, fittings can be easily changed, removed and reused.



PRODUCT DESCRIPTION		PART NUMBER	QTY/BAG
1/2" X 3/4" FNPT Reducing		U068LF	6
3/4" X 1/2" FNPT Bullnose		U092LF	6
3/4" X 3/4" FNPT Straight		U088LF	6
1" X 1" FNPT Straight		U094LF	6
LARGE DIAMETER	1-1/4" X 1-1/4" FNPT (For PEX applications, stiffeners are sold separately)	SB113532F	1
	1-1/2" X 1-1/2" FNPT (For PEX applications, stiffeners are sold separately)	SB114140F	1
	2" X 2" FNPT (For PEX applications, stiffeners are sold separately)	SB115450F	1
MALE CONNECTORS			
1/4" X 1/2" MNPT Reducing		U110LF	6
3/8" (1/2" OD) X 1/2" MNPT Reducing		U118LF	6
1/2" X 1/2" MNPT Straight		U120LF	12
1/2" X 3/4" MNPT Reducing		U116LF	6
3/4" X 1/2" MNPT Bullnose		U138LF	12
3/4" X 3/4" MNPT Straight		U134LF	12
3/4" X 1" MNPT Straight		U139LF	6
1" X 3/4" MNPT Reducing		U142LF	6
1" X 1" MNPT Straight		U140LF	6
LARGE DIAMETER	1-1/4" X 1-1/4" MNPT (For PEX applications, stiffeners are sold separately)	SB113532M	1
	1-1/2" X 1-1/2" MNPT (For PEX applications, stiffeners are sold separately)	SB114140M	1
	2" X 2" MNPT (For PEX applications, stiffeners are sold separately)	SB115450M	1
SLIP MALE CONNECTORS			
1/2" x 1/2" MNPT		U3120LF	6
3/4" x 3/4" MNPT		U3134LF	6
1" x 1" MNPT		U3140LF	6
THREADED ADAPTERS			
3/4" CTS X 3/4" FNPT Threaded (CTS end inserts into any 3/4" SB fitting)		U766LF	6
1" CTS X 1" FNPT Threaded (CTS end inserts into any 1" SB fitting)		U772LF	6
90° ELBOWS			
1/4" (3/8" OD) X 1/4" (3/8" OD)		U244LF	6
3/8" (1/2" OD) X 3/8" (1/2" OD)		U246LF	6
1/2" X 1/2"		U248LF	12
3/4" X 3/4"		U256LF	6
1" X 1"		U260LF	6
LARGE DIAMETER	1-1/4" X 1-1/4" (For PEX applications, stiffeners are sold separately)	SB0235	1
	1-1/2" X 1-1/2" (For PEX applications, stiffeners are sold separately)	SB0241	1
	2" X 2" (For PEX applications, stiffeners are sold separately)	SB0254	1
45° ELBOWS			
1/2" x 1/2"		U648LF	12
3/4" x 3/4"		U656LF	6
1" x 1"		U660LF	12
LARGE DIAMETER	1-1/4" X 1-1/4" (For PEX applications, stiffeners are sold separately)	SB0535	1
	1-1/2" X 1-1/2" (For PEX applications, stiffeners are sold separately)	SB0541	1
	2" X 2" (For PEX applications, stiffeners are sold separately)	SB0554	1

PRODUCT DESCRIPTION		PART NUMBER	QTY/BAG
45° STREET ELBOWS			
1/2" x 1/2" CTS Tail Adapter (CTS end inserts into any 1/2" SB fitting)		U615LF	6
3/4" x 3/4" CTS Tail Adapter (CTS end inserts into any 3/4" SB fitting)		U620LF	6
LARGE DIAMETER	1-1/4" X 1-1/4" (For PEX applications, stiffeners are sold separately)	SB0735	1
	1-1/2" X 1-1/2" (For PEX applications, stiffeners are sold separately)	SB0741	1
	2" X 2" (For PEX applications, stiffeners are sold separately)	SB0754	1
FEMALE ELBOWS			
1/2" X 1/2" FNPT		U308LF	6
3/4" X 3/4" FNPT		U314LF	3
MALE ELBOWS			
1/2" X 1/2" MNPT		U280LF	6
3/4" X 3/4" MNPT		U286LF	6
REDUCING ELBOWS			
1/2" X 3/8" (1/2" OD)		U272LF	12
3/4" X 1/2"		U274LF	6
1" X 3/4"		U278LF	3
DROP-EAR ELBOWS			
3/8" (1/2" OD) X 1/2" FNPT		U332LF	6
1/2" X 1/2"		U249LF	12
1/2" X 1/2" FNPT		U334LF	6
3/4" X 3/4" FNPT		U340LF	6
HY-EAR EAR ELBOWS			
1/2" X 1/2" Hy-Ear		U335LF	6
DISHWASHER ELBOWS			
1/4" (3/8" OD) X 3/8" MNPT		U276LF	6
1/4" (3/8" OD) X 3/4" Garden Hose Nut		U2276LF	6
1/2" X 3/8" MNPT		U281LF	6
TEES			
1/4" (3/8" OD) X 1/4" (3/8" OD) X 1/4" (3/8" OD)		U358LF	6
3/8" (1/2" OD) X 3/8" (1/2" OD) X 3/8" (1/2" OD)		U360LF	6
1/2" X 1/2" X 1/2"		U362LF	12
3/4" X 3/4" X 3/4"		U370LF	6
1" X 1" X 1"		U374LF	3
LARGE DIAMETER	1-1/4" X 1-1/4" X 1-1/4"	SB0835	1
	1-1/2" X 1-1/2" X 1-1/2"	SB0841	1
	2" X 2" X 2"	SB0854	1
REDUCING TEES			
3/8" (1/2" OD) X 3/8" (1/2" OD) X 1/2"		U364LF	6
1/2" X 1/2" X 1/4" (3/8" OD)		U359LF	6
1/2" X 1/2" X 3/8" (1/2" OD)		U363LF	6
3/4" X 1/2" X 1/2"		U454LF	6
3/4" X 3/4" X 1/2"		U412LF	6
3/4" X 1/2" X 3/4"		U444LF	6
1" X 1" X 3/4"		U416LF	3





PRODUCT DESCRIPTION		PART NUMBER	QTY/BAG
LARGE DIAMETER	1-1/4" X 1-1/4" X 1/2"	SB08353516	1
	1-1/4" X 1-1/4" X 3/4"	SB08353522	1
	1-1/4" X 1-1/4" X 1"	SB08353528	1
	1-1/2" X 1-1/2" X 3/4"	SB08414122	1
	1-1/2" X 1-1/2" X 1"	SB08414128	1
	1-1/2" X 1-1/2" X 1-1/4"	SB08414135	1
	2" X 2" X 1"	SB08545428	1
	2" X 2" X 1-1/4"	SB08545435	1
	2" X 2" X 1-1/2"	SB08545441	1
FEMALE CENTER TEES			
3/4" x 3/4" x 3/4" (Utilizes a U766LF thread adapter)		U462LF	3
1" x 1" x 1" (Utilizes a U772LF thread adapter)		U464LF	3
SLIP TEES (SLIP END ONLY SUITABLE FOR COPPER AND CPVC)			
1/2" X 1/2" X 1/2"		U3362LF	3
3/4" X 3/4" X 3/4"		U3370LF	3
LARGE DIAMETER	1-1/4" X 1-1/4" (For PEX applications, stiffeners are sold separately)	SB0335	1
	1-1/2" X 1-1/2" (For PEX applications, stiffeners are sold separately)	SB0341	1
	2" X 2" (For PEX applications, stiffeners are sold separately)	SB0354	1
FEMALE CENTER SLIP TEES (SLIP END ONLY SUITABLE FOR COPPER AND CPVC)			
1/2" X 1/2" X 1/2" FNPT		U3482LF	3
3/4" X 3/4" X 3/4" FNPT		U3486LF	3
SERVICE SLIP TEE ADAPTER (SLIP END ONLY SUITABLE FOR COPPER AND CPVC)			
1/2" X 1/2" X 1/2" CTS Tail Adapter Service Line Tee (CTS end inserts into any 1/2" SB fitting)		U4482LF	6
REDUCING SLIP TEES (ONLY SUITABLE FOR COPPER AND CPVC-MIDDLE BRANCH MAY BE USED WITH PEX)			
LARGE DIAMETER	1-1/4" X 1-1/4" X 1/2" (For PEX applications, stiffeners are sold separately)	SB03353516	1
	1-1/4" X 1-1/4" X 3/4" (For PEX applications, stiffeners are sold separately)	SB03353522	1
	1-1/4" X 1-1/4" X 1" (For PEX applications, stiffeners are sold separately)	SB03353528	1
	1-1/2" X 1-1/2" X 3/4" (For PEX applications, stiffeners are sold separately)	SB03414122	1
	1-1/2" X 1-1/2" X 1" (For PEX applications, stiffeners are sold separately)	SB03414128	1
	1-1/2" X 1-1/2" X 1-1/4" (For PEX applications, stiffeners are sold separately)	SB03414135	1
	2" X 2" X 1" (For PEX applications, stiffeners are sold separately)	SB03545428	1
	2" X 2" X 1-1/4" (For PEX applications, stiffeners are sold separately)	SB03545435	1
	2" X 2" X 1-1/2" (For PEX applications, stiffeners are sold separately)	SB03545441	1
END CAPS			
3/8" (1/2" OD)		U512LF	6
1/2"		U514LF	12
3/4"		U518LF	6
1"		U520LF	6
LARGE DIAMETER	1-1/4" (For PEX applications, stiffeners are sold separately)	SB0435	1
	1-1/2" (For PEX applications, stiffeners are sold separately)	SB0441	1
	2" (For PEX applications, stiffeners are sold separately)	SB0454	1
FITTING REDUCERS (USE TO CONNECT TO SMALLER PIPE SIZES)			
3/8" (1/2" OD) X 1/2" CTS (CTS end inserts into any 1/2" SB fitting)		U719LF	6
3/8" (1/2" OD) X 3/4" CTS (CTS end inserts into any 3/4" SB fitting)		U721LF	6
1/2" X 1" CTS (CTS end inserts into any 1" SB fitting)		U722LF	6

PRODUCT DESCRIPTION	PART NUMBER	QTY/BAG
3/4" X 1" CTS (CTS end inserts into any 1" SB fitting)	U724LF	6
WATER SOFTENER FITTING		
3/4" X 1" FIP	U086LF	12

1-B: RADIANT FITTINGS		
RADIANT FITTINGS (NON-POTABLE WATER APPLICATION)		
Non-potable water application fittings are manufactured with standard DZR brass.		
5/8" X 5/8" Coupling	U012	6
3/4" X 5/8" Reducing Coupling	U057	6
5/8" X 3/4" MNPT Reducing Adapter	U126	6
5/8" X 5/8" Elbow	U252	6
3/4" X 5/8" Elbow	U273	6
5/8" X 5/8" X 5/8" Tee	U366	6
5/8" End Stop	U516	6

1-C: TRANSITION FITTINGS		
POLYBUTYLENE TRANSITION COUPLINGS		
1/2" PB X 1/2" CTS	U4008LF	6
3/4" PB X 3/4" CTS	U4016LF	6
PVC TRANSITION COUPLINGS		
SharkBite PVC transition fittings connect Copper, PEX, CPVC, or PE-RT pipe to PVC pipe (Sch. 40, 80 and 120) without soldering, clamps, unions, or glue.		
1/2" CTS X 1/2" PVC	UIP4008	6
3/4" CTS X 3/4" PVC	UIP4016	6
1" CTS X 1" PVC	UIP4020	3
PVC TRANSITION SLIP TEES		
1/2" CTS X 1/2" CTS X 1/2" PVC	UIP363	3
1/2" PVC X 1/2" PVC X 1/2" CTS	UIP364	3
3/4" CTS X 3/4" CTS X 3/4" PVC	UIP371	3
3/4" PVC X 3/4" PVC X 3/4" CTS	UIP372	3
1" CTS X 1" CTS X 1" PVC	UIP375	3
1" PVC X 1" PVC X 1" CTS	UIP376	3
PVC SLIP COUPLINGS		
1/2" PVC X 1/2" PVC	UIP3008	3
3/4" PVC X 3/4" PVC	UIP3016	3
1" PVC X 1" PVC	UIP3020	2
PVC MALE CONNECTORS		
1/2" PVC X 1/2" MNPT	UIP120	6
3/4" PVC X 3/4" MNPT	UIP134	6
1" PVC X 1" MNPT	UIP140	3
PVC CAPS		
1/2"	UIP514	12
3/4"	UIP518	12
1"	UIP520	12

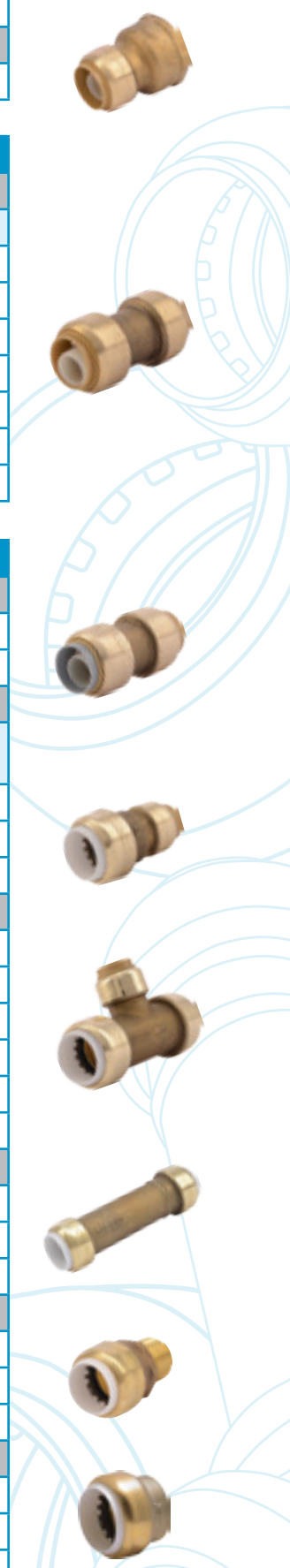



PRODUCT DESCRIPTION	PART NUMBER	QTY/BAG
PVC DEPTH GAUGE AND DISCONNECT CLIPS		
1/2"	UIP710	12
3/4"	UIP712	12
1"	UIP714	6



1-D: FIRE FITTINGS		
ONLY SUITABLE FOR USE WITH SHARKBITE PEX PIPE		
FIRE HORIZONTAL TEES		
3/4" x 3/4" x 1/2" FNPT	UF12128H	3
1" x 3/4" x 1/2" FNPT	UF16128H	3
1" x 1" x 1/2" FNPT	UF16168H	3
FIRE VERTICAL TEES		
3/4" x 3/4" x 1/2" FNPT	UF12128V	3
1" x 3/4" x 1/2" FNPT	UF16128V	3
1" x 1" x 1/2" FNPT	UF16168V	3
FIRE DROP-EAR ELBOWS		
3/4" x 1/2" FNPT	UF128U	3
1" x 1/2" FNPT	UF168U	3
FIRE THREADED FEMALE ADAPTERS		
3/4" x 1/2" FNPT	UF128S	3
FIRE ANGLED ADAPTERS		
3/4" x 3/4" x 1/2" FNPT	UF12128A	3
FIRE FEMALE ELBOWS		
3/4" x 1/2" FNPT Left	UF128L	3
3/4" x 1/2" FNPT Right	UF128R	3
1" x 1/2" FNPT Left	UF168L	3
1" x 1/2" FNPT Right	UF168R	3

1-E: FLEX HOSES

The SharkBite flexible connectors are used in residential and commercial applications to easily connect pipe in any combination. The SharkBite fitting allows the installer to connect to Copper, CPVC and PEX pipe eliminating the need for an additional transition fitting.

STAINLESS STEEL BRAIDED WATER HEATER CONNECTORS

The SharkBite water heater connectors are used in residential and commercial applications to connect the hot and cold supply lines to the water heater. The connectors are available in 12", 15", 18" and 24" lengths (with and without ball valve).

1/2" x 3/4" FIP, 12"	U3068FLEX12LF	12
1/2" x 3/4" FIP, 15"	U3068FLEX15LF	12
1/2" x 3/4" FIP, 18"	U3068FLEX18LF	12
1/2" x 3/4" FIP, 24"	U3068FLEX24LF	12
3/4" x 3/4" FIP, 12"	U3088FLEX12LF	12
3/4" x 3/4" FIP, 15"	U3088FLEX15LF	12
3/4" x 3/4" FIP, 18"	U3088FLEX18LF	12
3/4" x 3/4" FIP, 24"	U3088FLEX24LF	12
STAINLESS STEEL CORRUGATED WATER HEATER CONNECTORS		
3/4" x 3/4" FIP, 12"	SS3088FLEX12LF	12
3/4" x 3/4" FIP, 18"	SS3088FLEX18LF	12
3/4" x 3/4" FIP, 24"	SS3088FLEX24LF	12

PRODUCT DESCRIPTION	PART NUMBER	QTY/BAG
3/4" x 1" FIP, 24"	SS3086FLEX24LF	6
1" x 1" FIP, 24"	SS3094FLEX24LF	6
1" x 3/4" FIP, 24"	SS3096FLEX24LF	6
STAINLESS STEEL BRAIDED WATER HEATER CONNECTORS WITH BALL VALVES		
1/2" X 3/4" FIP, 18"	U3068FLEX18BVLV	12
3/4" X 3/4" FIP, 18"	U3088FLEX18BVLV	12
STAINLESS STEEL CORRUGATED WATER HEATER CONNECTORS WITH BALL VALVES		
1/2" X 3/4" FIP, 18"	SS3068FLEX18BV	12
3/4" X 3/4" FIP, 18"	SS3088FLEX18BV	12
STAINLESS STEEL CORRUGATED WATER HEATER CONNECTORS KIT		
Kit contains one 3/4" FIP x 3/4" SB x 18" hose, one 3/4" FIP x 3/4" SB ball valve x 18" hose, and one 3/4" disconnect clip	24680	3
STAINLESS STEEL BRAIDED WATER COUPLING HOSE		
1/2" X 1/2", 18"	U3008FLEX18LF	12
3/4" X 3/4", 18"	U3016FLEX18LF	12
STAINLESS STEEL BRAIDED WATER SOFTENER CONNECTOR		
The SharkBite water softener hose can be used for connection of new water softeners or replacement of existing connectors. The 3/4" SharkBite x 1" FIP swivel nut connectors makes for quick and easy installation.		
3/4" X 1" FIP, 24"	U3086FLEX24LF	6

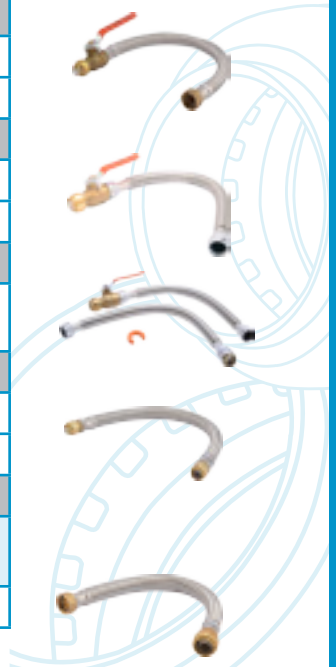

1-F: STOPS & FIXTURE SUPPLY FITTINGS

Connecting supply lines to fixtures and appliances using SharkBite stops & fixture supply fittings brings the speed and convenience of push-to-connect connections to the final phase of your plumbing jobs. Regular and chrome plated fittings are now available, including the newest 1/2" X 1/4" (3/8" OD) SharkBite stop valves. Stops in 1/2" X 3/8" or 1/4" compression sizes are also available. With these SharkBite push-to-connect fittings, stop valves and the 5' lengths or 50' coils of 1/4" (3/8" OD) PEX pipe, it's easy to make risers the exact length needed for connecting fixtures and appliances. No more problems with flexible lines that are too long or too short.

ANGLE STOPS

1/2" X 3/8" Compression	23036-0000LF	12
1/2" X 3/8" Compression Loose Key	24731LF	6
1/2" X 1/4" (3/8" OD)	23048-0000LF	6
1/2" X 1/4" (3/8" OD) Loose Key	24733LF	6
1/2" X 1/4" Compression	23336-0000LF	6
1/2" X 1/2" Compression	23489	6

STRAIGHT STOPS

1/2" X 3/8" Compression	23037-0000LF	12
1/2" X 3/8" Compression Loose Key	24732LF	6
1/2" X 1/4" (3/8" OD)	23049-0000LF	6
1/2" X 1/4" (3/8" OD) Loose Key	24734LF	6
1/2" X 1/4" Compression	23337-0000LF	6
1/2" X 1/2" Compression	23490	6

TEE STOPS

1/2" X 1/2" X 1/4" Compression	24983	6
1/2" X 1/2" X 3/8" Compression	24984	6
3/4" X 3/4" X 1/4" Compression	24985	6





PRODUCT DESCRIPTION	PART NUMBER	QTY/BAG
3/4" X 3/4" X 3/8" Compression	24986	6
1/2" X 1/2" X 1/4" (3/8" OD)	24987	6
DUAL OUTLET STOP		
1/2" Angle Stop X 3/8" X 3/8" OD Comp Dual Outlet Stop	25558LF	6
DUAL TEE STOP VALVE ADAPTERS		
Insert onto stub-out then fit any of the eight SharkBite stop valves to create any combination desired.		
1/2" CTS X 1/2" CTS X 1/2" (CTS ends insert into any 1/2" SB fitting. Recommended use with Angle/Straight Stops.)	U782LF	6
STOP VALVE CONNECTORS		
1/4" (3/8" OD) X 3/8" Compression Stop Valve Connector (Converts 3/8" comp stop to SharkBite)	U3523LF	6
1/4" (3/8" OD) X 1/4" Compression Nut	U3524LF	6
STOP VALVE TEE ADAPTERS		
1/4" (3/8" OD) X 1/4" (3/8" OD) X 3/8" Compression	U3358LF	6
1/4" (3/8" OD) X 1/4" (3/8" OD) X 1/4" (3/8" OD) Tube	U4358LF	6
FAUCET CONNECTORS		
1/4" (3/8" OD) X 1/2" NPSM	U3525LF	6
TOILET CONNECTORS		
1/4" (3/8" OD) X 7/8" Ballcock Threads Toilet Connector	U3531LF	6
1/4" (3/8" OD) X 7/8" Ballcock Threads Toilet Elbow	U3537LF	6
ANGLE STOP SUPPLY LINES		
1/2" X 7/8" Ballcock Click Seal® Toilet Connector x 12"*	24656	6
1/2" X 1/2" NPSM ClickSeal® Faucet Connector x 20"*	24657	6

1-G: ADDITIONAL PRODUCTS

MANIFOLDS WITH PUSH-TO-CONNECT BRANCHES

Manifolds are traditionally used in PEX systems, but this SharkBite manifold will also allow for easy incorporation into Copper or CPVC systems. Use SharkBite push-to-connect fittings to install these manifolds anywhere in a plumbing system. All manifolds have a 1" trunk with 3/4" tube inlets and outlets and 1/2" push-to-connect ports (2" on center).

Manifold Bracket Set (for 1"-1.5" diameter manifolds)	25484Z	1
3/4" x 1/2" Outlet 3-Port Manifold - Open	25552LF	3
3/4" x 1/2" Outlet 3-Port Manifold - Closed	25553LF	3
3/4" x 1/2" Outlet 4-Port Manifold - Open	25554LF	3
3/4" x 1/2" Outlet 4-Port Manifold - Closed	25555LF	3

RADIANT HEATING MANIFOLDS (1" FNPT X 1/2" SHARKBITE PEX LOOPS)

3 Loop	24930	1
4 Loop	24931	1
5 Loop	24932	1
6 Loop	24933	1
7 Loop	24934	1
8 Loop	24935	1
9 Loop	24936	1
10 Loop	24937	1
11 Loop	24938	1
12 Loop	24939	1
13 Loop	24940	1

*Click Seal® is a registered trademark of Fluidmaster, Inc.

PRODUCT DESCRIPTION	PART NUMBER	QTY/BAG
SHARKBITE RADIANT MANIFOLD ACTUATORS (4-WIRE, WITH END SWITCH)		
SharkBite Radiant Manifold Actuator	24963	1
WATER HAMMER ARRESTORS		
Provides maintenance-free, continuous protection against water hammer. Can be positioned vertically or horizontally and the SHARKBITE connectors allow the arrestor to be installed in seconds, even on wet pipe.		
1/2" Residential	22630LF	1
1/2" Commercial	22631LF	1
3/4" Residential	22632LF	1
1" Commercial	22633LF	1
STUB OUT ELBOWS		
The SharkBite stub-out elbows come with pre-fitted mounting brackets that provide four fixed installation positions on all wooden surfaces (studs, joists and subfloors) by simply rotating or repositioning the mounting bracket.		
1/2" SB X 1/2" Copper Tube 8" Length	U351LFA	6
PRESSURE GAUGES		
1/2" SB Tee with Pressure Gauge	24436	1
3/4" SB Tee with Pressure Gauge	24438	1
3/4" SB Pressure Gauge in Retail Packaging	24438A	5
1" SB Tee with Pressure Gauge	24440	1
1/2" CTS Pressure Gauge (inserts into any 1/2" SB fitting)	24442	1
3/4" CTS Pressure Gauge (inserts into any 3/4" SB fitting)	24444	1
TEMPERATURE GAUGES		
1/2" SB Tee with Temperature Gauge	24437	1
3/4" SB Tee with Temperature Gauge	24439	1
1" SB Tee with Temperature Gauge	24441	1
1/2" CTS Temperature Gauge (inserts into any 1/2" SB fitting)	24443	1
3/4" CTS Temperature Gauge (inserts into any 3/4" SB fitting)	24445	1
PUSH-TO-CONNECT HOME RUN MANIFOLDS		
12 Port with Brass Valves	PM012SB	1
24 Port with Brass Valves	PM024SB	1

1-H: KITS		
WATER HEATER INSTALLATION KITS (KITS INCLUDE 2 SHARKBITE CONNECTOR FITTINGS AND A DISCONNECT CLIP)		
1/2" X 3/4" FNPT	22604LF	12
3/4" X 3/4" FNPT	22441LF	12
CONTRACTOR KITS (KIT INCLUDES TOOLBOX)		
Kit Contains 2 each (U008LF, U016LF, U058LF, U072LF, U088LF, U120LF, U134LF, U248LF, U256LF) and 1 each (U362LF, U370LF, U514LF, U518LF, U710, U711, U713 and U702)	22486LF	1
Contractor Tool Box Only	U3001A	1
FAUCET CONNECTION KIT IN BAGGED PACKAGING (FAUCET KITS COME WITH 2 FAUCET CONNECTORS, 2 ANGLE STOPS, AND 1 COIL OF 10' 1/4" WHITE PEX PIPE)		
Faucet Connector with Angle Stop	25087	3
Faucet Connector with Straight Stop	25538	3
TOILET CONNECTION KIT IN BAGGED PACKAGING (TOILET KITS COME WITH 1 TOILET CONNECTOR, 1 ANGLE STOP, AND 1 COIL OF 5' 1/4" WHITE PEX PIPE.)		
Toilet Connector with Angle Stop	25088	6
Toilet Connector with Straight Stop	25539	3



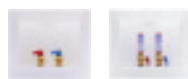

PRODUCT DESCRIPTION	PART NUMBER	QTY/BAG
ICE MAKER CONNECTION KIT IN BAGGED PACKAGING (ICE MAKER KITS COME WITH 1 SERVICE SLIP TEE, 1 ANGLE STOP, 1 VALVE CONNECTOR, 10' 1/4" WHITE PEX PIPE)		
Ice Maker Connector with Angle Stop	25024	1
DISHWASHER INSTALLATION KIT IN BAGGED PACKAGING (DISHWASHER KIT COMES WITH 1 DUAL OUTLET STOP, 1 STOP VALVE CONNECTOR, 1 DISHWASHER ELBOW, 1 GARDEN HOSE NUT)		
Dishwasher Installation Kit	25568	3
SHOWER/TUB INSTALLATION KIT IN BAGGED PACKAGING		
KIT Contains 2 Drop Ear Elbows, 2 Female Connectors, 2 Female Elbows and 1 Disconnect Clip	25567	3
WATER FILTER INSTALLATION KIT IN BAGGED PACKAGING (WATER FILTER KIT COMES WITH 1 SLIP COUPLING, 1 MALE CONNECTOR, AND 1 DISCONNECT CLIP)		
Kit Contains 1 - 3/4" Slip Connector, 1 - 3/4" Male Connector, and 1 - 3/4" Disconnect Clip	25561	6
Kit Contains 1 - 1" Slip Connector, 1 - 1" Male Connector, and 1 - 1" Disconnect Clip	25562	6
ICE MAKER OUTLET BOX		
1/2" SB X 1/4" Compression	25096	1
1/2" SB X 1/4" Compression with Water Hammer Arrestor	25097	1
WASHING MACHINE OUTLET BOX		
1/2" SB X 3/4" MHT	25098	1
1/2" SB X 3/4" MHT with Water Hammer Arrestor	25099	1
FACEPLATE REPLACEMENTS		
Ice Maker Box Replacement Faceplate for 25032, 25033, 25096, 25097	25478	1
Washing Machine Box Replacement Faceplate for 24763, 25031, 25098, 25099	25464	1
WASHING MACHINE VALVES		
1/2" X 3/4" MHT Straight Valve	25559LF	6
1/2" X 3/4" MHT Angle Valve	25560LF	6

1-I: TOOLS

DEBURR & GAUGE TOOLS			
	Use for 1/4", 3/8", 1/2", 5/8", 3/4" and 1" copper and CPVC pipe	U702	1
LARGE DIAMETER	Use for 1-1/4", 1-1/2", 2"	SBG03	1
DISCONNECT CLIPS			
	1/4"	U706	12
	3/8"	U708	24
	1/2"	U710	24
	5/8"	U3712	24
	3/4"	U712	24
	1"	U714	12
DISCONNECT TONGS			
	1/2"	U711	1
	3/4"	U713	1
	1"	U715	1
DE-MOUNT CLIPS			
LARGE DIAMETER	1-1/4"	SBDC35	1
	1-1/2"	SBDC41	1
	2"	SBDC54	1
	1-1/4", 1-1/2", 2" Kit	SBDC354154	1

PRODUCT DESCRIPTION		PART NUMBER	QTY/BAG
LARGE DIAMETER PEX STIFFENERS			
LARGE DIAMETER	1-1/4"	SBTL35	1
	1-1/2"	SBTL41	1
	2"	SBTL54	1
WRAP FOR FITTING BURIAL			
10' x 2" X 0.02" Silicone Wrap		25406	1

SECTION 2: SHARKBITE VALVES

2-A: PRESSURE REGULATING VALVES

The innovative, labor reducing EB45 and the EB25 pressure regulating valves are available with double union and direct SharkBite connectors. The EB45 is factory set at 45 or 60 psi and is adjustable to 10-70 psi. The EB25 is set at 45 psi and features a twist cap with a numerical pressure indicator for easy one-man adjustment.

EB45 LEAD FREE SHARKBITE CONNECTIONS (ALL EB45 VALVES FACTORY SET AT 45 PSI UNLESS SPECIFIED)

1/2" EB45-DSB Direct SharkBite	23807-0045	1
1/2" EB45-SDSB Slip Feature Direct SharkBite	24383-0045	1
1/2" EB45-DUSB Double Union SharkBite	23893-0045	1
3/4" EB45-DSB Direct SharkBite	23808-0045	1
3/4" EB45-SDSB Slip Feature Direct SharkBite	24384-0045	1
3/4" EB45-DUSB Double Union SharkBite	23894-0045	1
3/4" EB45 Double Union SharkBite (60 psi setting)	23896-0060	1
3/4" EB45-DUSB Double Union SharkBite with Gauge	24449-0045	1
1" EB45-DSB Direct SharkBite	22675-0045	1
1" EB45-DUSB Double Union SharkBite	23358-0045	1
1" EB45-DUSB Double Union SharkBite (60 psi setting)	23945-0060	1

EB25 LEAD FREE SHARKBITE CONNECTIONS

3/4" EB25-DUSB Double Union SharkBite	23955-0045	1
1" EB25-DUSB Double Union SharkBite	23956-0045	1

A-89 BOILER FEED VALVES

1/2" A-89 Direct SharkBite	25521Z	1
----------------------------	--------	---

2-B: THERMOSTATIC MIXING VALVES

Direct or double union SharkBite push-to-connect connectors provide a simplified, time and labor saving installation. Heatguard® valves deliver water at a safe 120°F (49°C) or lower from all outlets, while allowing the thermostat to be set at a germ-killing 140°F (60°C) or higher which aids in preventing the growth of legionella bacteria in the water heater. The higher tank temperature means hot water demands can be satisfied longer. Every valve is tested for performance and includes a unique adjuster tool that minimizes tampering with the valve setting. Rugged, simple construction incorporates a precise engineered polymer piston and the latest in thermostatic technology.

HG110-D LEAD FREE (ASSE 1017, 1069, & 1070, CSA B 125.3. DISTRIBUTION AND IN-LINE)

1/2" HG110-D with Integrated SharkBite Connections and Integral Checks	24548	1
3/4" HG110-D with Integrated SharkBite Connections and Integral Checks	24549	1
1/2" HG110-D with SharkBite Union Connections	24504	1
3/4" HG110-D with SharkBite Union Connections	24505	1

HG160 LEAD FREE (ASSE 1069 & 1070, CSA B 125.3. IN-LINE)

1/2" HG160 with SharkBite Connections	24529	1
3/4" HG160 with SharkBite Connections	24530	1





PRODUCT DESCRIPTION	PART NUMBER	QTY/BAG
HG110-HX		
3/4" HG110-HX with SharkBite Connections and Integral Checks	24867	1

2-C: BALL VALVES

BALL VALVES			
1/2" X 1/2"	22222-0000LF	12	
3/4" X 3/4"	22185-0000LF	12	
1" X 1"	22223-0000LF	6	
LARGE DIAMETER	1-1/4"	SBBV35	1
	1-1/2"	SBBV41	1
	2"	SBBV54	1
BALL VALVES WITH FNPT CONNECTORS			
1/2" X 1/2" FNPT	22182-0000LF	6	
3/4" X 3/4" FNPT	22186-0000LF	6	
1" X 1" FNPT	22187-0000LF	3	
BALL VALVES WITH DRAIN / VENT			
1/2" x 1/2" x 1/8" NPSM Drain Thread	22304-0000LF	12	
3/4" x 3/4" 1/8" NPSM Drain Thread	22305-0000LF	12	
1" x 1" 1/8" NPSM Drain Thread	22306-0000LF	6	
BALL VALVE WITH DRAIN / VENT AND MOUNTING BRACKET			
1/2" x 1/2" 1/8" NPSM Drain Thread	24615-0000LF	12	
3/4" x 3/4" 1/8" NPSM Drain Thread	24616-0000LF	6	
1" x 1" 1/8" NPSM Drain Thread	24617-0000LF	6	
1/8" NPSM	24377	1	
SLIP BALL VALVE (ONLY SUITABLE FOR COPPER AND CPVC)			
1/2" x 1/2"	24735LF	6	
3/4" x 3/4"	24736LF	6	
1" x 1"	24737LF	3	

2-D: PVC BALL VALVES

PVC BALL VALVES		
3/4" PVC X 3/4" CTS	25550LF	6
1" PVC X 3/4" CTS	25551LF	6

2-E: CHECK VALVES

CHECK VALVES		
1/2" X 1/2"	U2008-0000LF	6
3/4" X 3/4"	U2016-0000LF	6
1" X 1"	U2020-0000LF	3
DUAL CHECK VALVES (ASSE 1024 & CSA B64.6)		
3/4" BF1, Dual Check, SharkBite Inlet & Outlet	BF13434SB	1
1" BF1, Dual Check, SharkBite Inlet & Outlet	BF10101SB	1
1" X 3/4" BF5, Dual Check, Meter Swivel Nut Inlet, SharkBite Outlet	BF5M0134SB	1
1-1/4" X 1" BF5, Dual Check, Meter Swivel Nut Inlet, SharkBite Outlet	BF5M1401SB	1

PRODUCT DESCRIPTION	PART NUMBER	QTY/BAG
2-F: TEMPERATURE & PRESSURE RELIEF VALVES		
T&P RELIEF VALVES		
3/4" NCLX-5LX with SharkBite Outlet Connection	24609-0150	1

2-G: GENERAL SUPPLY VALVES		
GATE VALVE WITH DRAIN		
1/2" x 1/2"	24634LF	12
3/4" x 3/4"	24635LF	12
HOSE BIBBS		
1/2" x 3/4" MHT 90 Deg Hose Bibb – Quarter Turn	24620LF	6
3/4" x 3/4" MHT 90 Deg Hose Bibb – Quarter-Turn	24621LF	6
1/2" x 3/4" MHT 90 Deg Hose Bibb – Multi-Turn	24626LF	6
3/4" x 3/4" MHT 90 Deg Hose Bibb - Multi-Turn	24627LF	6
1/2" x 3/4" MHT No-Kink 45 Deg Hose Bibb – Quarter Turn	24630LF	6
3/4" x 3/4" MHT No-Kink 45 Deg Hose Bibb – Quarter-Turn	24631LF	6
1/2" x 3/4" MHT No-Kink 45 Deg Hose Bibb – Multi-Turn	24632LF	6
3/4" x 3/4" MHT No-Kink 45 Deg Hose Bibb - Multi-Turn	24633LF	6
GARDEN VALVES		
1/2" x 3/4" MHT	24622LF	6
3/4" x 3/4" MHT	24623LF	6
ANTI-SIPHON FROST-FREE SILLCOCK		
1/2" x 3/4" MHT 8"	24628LF	4
1/2" x 3/4" MHT 10"	24629LF	4
1/2" x 3/4" MHT 12"	24636LF	4
1/2" x 3/4" MHT 15"	24637LF	4
1/2" x 3/4" MHT 18"	24638LF	4

SECTION 3: SHARKBITE PEX BARB FITTINGS

3-A: PEX BARB CORE FITTINGS

The SharkBite PEX/Barb Connection System is the best option for connecting PEX pipe in water distribution systems when lower material cost is desired. Robustly constructed with Lead Free DZR brass, the SharkBite barb fittings are corrosion resistant. With a wide range of fittings, manifolds, valves, clamp rings, crimp rings, ball valves and tools available, the SharkBite PEX/Barb Connection System is perfect for your next plumbing project.

COUPLINGS			
3/8" x 3/8"	UC006LF	10	
1/2" x 1/2"	UC008LF	25	
5/8" x 5/8"	UC012LF	10	
3/4" x 3/4"	UC016LF	25	
1" x 1"	UC020LF	10	
LARGE DIAMETER	1-1/4"	UC0135	20
	1-1/2"	UC0141	20
	2"	UC0154	15
REDUCING COUPLINGS			
3/8" X 1/2"	UC009LF	10	
1/2" X 3/4"	UC058LF	25	





PRODUCT DESCRIPTION		PART NUMBER	QTY/BAG
3/4" X 5/8"		UC057LF	10
3/4" X 1"		UC060LF	25
LARGE DIAMETER	1-1/4" x 3/4"	UC013522	20
	1-1/4" x 1"	UC013528	20
	1-1/2" x 3/4"	UC014122	15
	1-1/2" x 1"	UC014135	20
	1-1/2" x 1-1/4"	UC014135	20
	2" x 1-1/2"	UC015441	20
THREADED FEMALE ADAPTERS			
1/2" X 3/4" FNPT		UC068LF	25
1/2" X 1/2" FNPT		UC072LF	25
3/4" X 3/4" FNPT		UC088LF	25
1" X 1" FNPT		UC094LF	10
THREADED MALE ADAPTERS			
3/8" X 1/2" MNPT		UC118LF	10
1/2" X 1/2" MNPT		UC120LF	25
1/2" X 3/4" MNPT		UC116LF	25
3/4" X 1/2" MNPT		UC138LF	25
3/4" X 3/4" MNPT		UC134LF	25
3/4" X 1" MNPT		UC139LF	10
1" X 3/4" MNPT		UC142LF	10
1" X 1" MNPT		UC140LF	10
SWEAT FEMALE ADAPTERS			
1/2" X 1/2"		UC600LF	25
3/4" X 3/4"		UC606LF	25
1" X 1"		UC605LF	10
SWEAT MALE ADAPTERS			
1/2" X 1/2"		UC607LF	25
3/4" X 3/4"		UC608LF	25
1" X 1"		UC609LF	10
ELBOWS			
3/8" X 3/8"		UC246LF	10
1/2" X 1/2"		UC248LF	25
3/4" X 3/4"		UC256LF	25
1" X 1"		UC260LF	10
1-1/4" x 1-1/4"		UC0235	10
1-1/2" x 1-1/2"		UC0241	10
2" x 2"		UC0254	10
REDUCING ELBOWS			
1/2" X 3/8"		UC272LF	10
1/2" X 3/4"		UC274LF	25
3/4" X 5/8"		UC273LF	10
DROP-EAR ELBOWS			
1/2" X 1/2" FNPT Drop Ear		UC334LF	25
3/4" X 3/4" FNPT Drop Ear		UC340LF	25
3/4" X 1/2" FNPT Drop Ear		UC342LF	25

PRODUCT DESCRIPTION		PART NUMBER	QTY/BAG
ADAPTER ELBOWS			
1/2" X 1/2" MNPT		UC280LF	25
1/2" X 3/4" MNPT		UC278LF	25
3/4" X 3/4" MNPT		UC286LF	25
3/4" X 3/4" Female Sweat		UC626LF	25
3/4" X 3/4" Male Sweat		UC628LF	25
TEES			
3/8" X 3/8" X 3/8"		UC360LF	10
1/2" X 1/2" X 1/2"		UC362LF	25
3/4" X 3/4" X 3/4"		UC370LF	25
1" X 1" X 1"		UC374LF	10
LARGE DIAMETER	1-1/4"	UC0835	10
	1-1/2"	UC0841	5
	2"	UC0854	5
BULLNOSE TEES			
1/2" X 1/2" X 3/4" Bull Nose		UC408LF	25
3/4" X 3/4" X 1" Bull Nose		UC413LF	10
REDUCING TEES			
3/8" X 3/8" X 1/2"		UC364LF	10
1/2" X 3/8" X 3/8"		UC452LF	10
1/2" X 1/2" X 3/8"		UC363LF	10
1/2" X 3/8" X 1/2"		UC434LF	10
3/4" X 3/4" X 3/8"		UC417LF	10
3/4" X 3/4" X 1/2"		UC412LF	25
3/4" X 1/2" X 1/2"		UC454LF	25
3/4" X 1/2" X 3/4"		UC444LF	25
1" X 3/4" X 3/4"		UC414LF	10
1" X 1" X 1/2"		UC415LF	10
1" X 1" X 3/4"		UC416LF	10
1" X 3/4" X 1"		UC418LF	10
LARGE DIAMETER	1-1/4" x 1" x 1"	UC08352828	10
	1-1/4" x 1-1/4" x 1/2"	UC08353516	10
	1-1/4" x 1-1/4" x 3/4"	UC08353522	10
	1-1/4" x 1-1/4" x 1"	UC08353528	10
	1-1/2" x 1-1/2" x 1"	UC08413528	5
	1-1/2" x 1-1/2" x 1/2"	UC08414116	5
	1-1/2" x 1-1/2" x 3/4"	UC08414122	10
	1-1/2" x 1-1/2" x 1"	UC08414128	5
	1-1/2" x 1-1/2" x 1-1/4"	UC08414135	5
	2" x 2" x 1/2"	UC08545416	5
	2" x 2" x 3/4"	UC08545422	5
	2" x 2" x 1"	UC08545428	5
	2" x 2" x 1-1/2"	UC08545441	5





PRODUCT DESCRIPTION		PART NUMBER	QTY/BAG
SWIVEL ADAPTERS			
3/8" X 3/8" NPSM		UC527LF	10
1/2" X 1/2" NPSM		UC526LF	25
1/2" X 3/4" NPSM		UC534LF	25
3/4" X 3/4" NPSM		UC530LF	25
3/4" X 1" NPSM		UC529LF	10
1" X 1" NPSM		UC594LF	10
SWIVEL ELBOWS			
3/8" X 1/2" NPSM		UC531LF	10
1/2" X 1/2" NPSM		UC532LF	25
SWIVEL TOILET CONNECTION ELBOWS			
1/2" X 7/8" BC Straight		UC528LF	10
3/8" X 7/8" BC Elbow		23068LF	6
1/2" X 7/8" BC Elbow		23067LF	6
PLUGS			
3/8"		UC512LF	10
1/2"		UC514LF	25
3/4"		UC518LF	25
1"		UC520LF	10
LARGE DIAMETER	1-1/4"	UC0435	40
	1-1/2"	UC0441	30
	2"	UC0454	20

3-B: PEX BARB TRANSITION FITTINGS

POLYBUTYLENE TRANSITION COUPLINGS (WITH PB CRIMP RING)

3/8"	UC4006LF	10
1/2"	UC4008LF	25
3/4"	UC4016LF	25

3-C: PEX BARB POLY ALLOY FITTINGS

The SharkBite PEX poly alloy fittings range is an advanced plumbing solution when corrosion may effect DZR brass products.

COUPLINGS

1/2" x 1/2"	UP008	25
3/4" x 3/4"	UP016	25
1" x 1"	UP020	25

REDUCING COUPLINGS

3/4" X 1/2"	UP058	25
1" X 3/4"	UP060	25

CONNECTORS

1/2" X 1/2" MNPT	UP120	25
3/4" X 3/4" MNPT	UP134	25
1" X 1" MNPT	UP140	25
3/4" X 1/2" MNPT	UP138	25



PRODUCT DESCRIPTION	PART NUMBER	QTY/BAG
ELBOWS		
1/2" x 1/2"	UP248	25
3/4" x 3/4"	UP256	25
1" x 1"	UP260	25
MALE ELBOWS		
1/2" X 1/2" MNPT	UP280	25
REDUCING ELBOWS		
3/4" X 1/2"	UP274	25
TEES		
3/8" x 3/8" x 3/8"	UP360	10
1/2" x 1/2" x 1/2"	UP362	25
3/4" x 3/4" x 3/4"	UP370	25
1" x 1" x 1"	UP374	25
REDUCING TEES		
1/2" X 1/2" X 3/4"	UP408	25
3/4" X 1/2" X 1/2"	UP454	25
3/4" X 3/4" X 1/2"	UP412	25
3/4" X 1/2" X 3/4"	UP444	25
1" X 3/4" X 3/4"	UP414	25
1" X 1" X 1/2"	UP415	25
1" X 1" X 3/4"	UP416	25
PLUGS		
1/2"	UP514	25
3/4"	UP518	25
1"	UP520	25
ADAPTERS		
1/2" x 1/2" NPSM	UP526	25
3/8" x 1/2" NPSM	UP527	10
1/2" x 1/2" NPSM Elbow	UP532	25



3-D: PEX BARB FIRE FITTINGS		
FIRE HORIZONTAL TEES		
3/4" x 3/4" x 1/2" FNPT	UCF12128H	1
1" x 3/4" x 1/2" FNPT	UCF16128H	1
1" x 1" x 1/2" FNPT	UCF16168H	1
FIRE VERTICAL TEES		
3/4" x 3/4" x 1" FNPT	UCF12128V	1
1" x 3/4" x 1/2" FNPT	UCF16128V	1
1" x 1" x 1/2" FNPT	UCF16168V	1
FIRE DROP-EAR ELBOWS		
3/4" x 1/2" FNPT	UCF128U	1
1" X 1/2" FNPT	UCF168U	1
FIRE THREADED FEMALE ADAPTERS		
3/4" X 1/2" FNPT	UCF128S	1



PRODUCT DESCRIPTION	PART NUMBER	QTY/BAG
FIRE ANGLED ADAPTERS		
3/4" X 3/4" X 1/2" FNPT	UCF12128A	1
FIRE FEMALE ELBOWS		
3/4" X 1/2" FNPT Left	UCF128L	1
3/4" X 1/2" FNPT Right	UCF128R	1
1" X 1/2" FNPT Left	UCF168L	1
1" X 1/2" FNPT Right	UCF168R	1



3-E: PEX BARB STOPS & FIXTURE SUPPLY FITTINGS		
PEX CHROME PLATED QUARTER TURN ANGLE STOPS		
1/2" X 3/8" OD Compression (Quarter Turn)	23058LF	24
1/2" X 1/4" OD Compression (Quarter Turn)	23056LF	6
PEX CHROME PLATED QUARTER TURN STRAIGHT STOPS		
3/8" X 3/8" (Quarter Turn)	23382LF	6
1/2" X 3/8" OD Compression (Quarter Turn)	23057LF	24
PEX CHROME PLATED STRAIGHT STOPS		
1/2" X 3/8" Compression	23059LF	24
1/2" X 3/8"	23062LF	6
1/2" X 1/2" MPT	23061LF	6
1/2" X 1/2"	23063LF	12
PEX CHROME PLATED ANGLE STOPS		
1/2" X 3/8" Compression	23060LF	12
1/2" X 3/4" MHT	23064LF	6
PEX CHROME PLATED ANGLE DUAL OUTLET STOPS		
1/2" X 3/8" X 3/8" Compression Angle Stop	23066LF	6

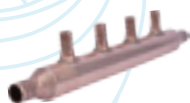

3-F: PEX BARB ADDITIONAL PRODUCTS		
COPPER STUBOUT ELBOWS (ALL COPPER STUBOUT ELBOWS ARE LEAD FREE)		
1/2" X Closed (4" X 8")	22791	12
3/8" X 1/2" (4" X 4")	23069	6
1/2" X 1/2" (4" X 4")	23070	6
COPPER MANIFOLDS WITH BARB BRANCHES (1" TRUNK WITH 3/4" BARB INLETS & OUTLETS AND 1/2" BARB PORTS - 2" ON CENTER) LEAD FREE		
Manifold Bracket Set (for 1"-1.5" diameter manifolds)	25484Z	1
3 Port Closed	22783	1
3 Port Open	22784	1
4 Port Closed	22785	1
4 Port Open	22786	1
6 Port Closed	22787	1
6 Port Open	22788	1
8 Port Closed	22789	1
8 Port Open	22790	1
WATER HAMMER ARRESTORS (PROVIDES MAINTENANCE-FREE, CONTINUOUS PROTECTION AGAINST WATER HAMMER. CAN BE POSITIONED VERTICALLY OR HORIZONTALLY)		
1/2" Residential	25401	1

PRODUCT DESCRIPTION	PART NUMBER	QTY/BAG
BARB HOME RUN MANIFOLDS		
Manifold 12 Port with Brass Ball Valves	RM22712	1
Manifold 24 Port with Brass Ball Valves	RM22724	1
Manifold 12 Port with Polly Ball Valves	PM012UP	1
Manifold 24 Port with Polly Ball Valves	PM024UP	1
BARB BALL VALVES		
1/2" x 1/2"	22461LF	12
3/4" x 3/4"	22462LF	12
1" x 1"	22463LF	6

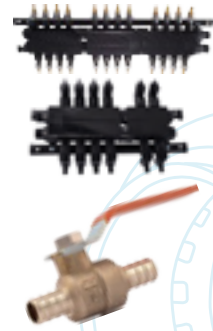

3-G: PEX BARB ACCESSORIES		
CLAMP RINGS (STAINLESS STEEL)		
3/8"	UC952	100
1/2"	UC953	100
5/8"	UC954	50
3/4"	UC955	100
1"	UC956	50
CRIMP RINGS (COPPER)		
3/8" (25 Pack)	23101CP25	6
3/8" (100 Pack)	23101CP100	6
1/2" (25 Pack)	23102CP25	24
1/2" (100 Pack)	23102CP100	6
3/4" (25 Pack)	23103CP25	12
3/4" (100 Pack)	23103CP100	6
1" (25 Pack)	23104CP25	6
CRIMP RINGS (COPPER)		
3/8"	23101	100
1/2"	23102	100
3/4"	23103	100
1"	23104	25
PEX BEND SUPPORTS, SUSPENSION CLAMPS AND INSULATORS		
3/8" J Hook PEX Pipe Clamp (10 Pack)	23065	12
1/2" J Hook PEX Pipe Clamp (10 Pack)	23220	12
1/2" J Hook PEX Pipe Clamp (100 Pack)	23220Z100	5
3/4" J Hook PEX Pipe Clamp (10 Pack)	23221	12
1/2" Insulated Suspension Clamp (10 Pack)	23071A10	6
3/4" Insulated Suspension Clamp (10 Pack)	23072A10	6
1" Insulated Suspension Clamp (10 Pack)	23073A10	6
1/2" Pipe Insulator (10 Pack)	23074A10	6
3/4" Pipe Insulator (10 Pack)	23075A10	6
1" Pipe Insulator (10 Pack)	23076A10	6
1/2" Polymer Bend Support with mounting bracket	23050	12
3/4" Polymer Bend Support	23051	6
1/2" Metal Pipe Support	23053	12
3/4" Metal Pipe Support	23054	12





PRODUCT DESCRIPTION	PART NUMBER	QTY/BAG
RADIANT INSTALLATION COMPONENTS		
1/2" PEX Wire Mesh Installation Clips (25 Pack)	25485Z25	1
1/2" PEX Foam Insulation Twist Clips (25 Pack)	25486Z25	1
1/2" PEX Conduit Slab Support	25490Z	10

3-H: PEX BARB TOOLS		
PEX CRIMP TOOLS		
1/2", 3/4" PEX Combo Crimp Tool	23251	1
3/8", 1/2", 3/4" PEX Pocket Crimp Tool	23383	1
PEX CRIMP TOOL KIT		
3/8", 1/2", 3/4", 1" PEX Crimp Ring Tool Kit (Crimp Ring Gauge included)	23100	1
1-1/4", 1-1/2", 2" Crimp Tool	24675	1
PEX CLAMP TOOLS		
PEX Clamp Tool One-hand Operation	UC961	1
PEX Clamp Tool Standard Handles	23081	1
PEX PIPE CUTTER		
PEX Pipe Cutter	U701	1
CRIMP RING GAUGE		
3/8", 1/2", 3/4", 1" PEX Crimp Ring Gauge	23080	6
CRIMP RING REMOVAL TOOL		
PEX Crimp Ring Removal Tool	23055	6
PEX DECOILER		
PEX Decoiler	UFH034	1

Benefits of SharkBite® PEX



Health/Safety

No glue, solder, or solvents required for the connection process, which keeps potentially dangerous chemicals out of plumbing systems. Additionally, SharkBite PEX Pipe eliminates the need for open flames in the house that could be a potential fire hazard. There is no risk of copper traces in water from breakdown of pipe that has been linked to heart disease and Alzheimer's.



Versatile

SharkBite PEX Pipe can be installed in dry or wet conditions. SharkBite PEX Pipe can lend itself to many applications due to its physical properties of flexibility, reliability and installation ease such as hydronic heating, fire protection, etc.



Chlorine Resistance

SharkBite PEX Pipe is tested to the highest level of chlorine resistance standards, testing at 100% chlorine at 140°F.



Proven and Guaranteed

SharkBite PEX Pipe has been around for more than 35 years with over 12 Billion feet of pipe installed worldwide.



Freeze Resistant

SharkBite PEX Pipe is freeze resistant as the pipe can expand and contract as water freezes and thaws within the pipe.



Flexibility

Able to bend pipe around corners which removes the need for 45° or 90° elbows in certain situations. SharkBite's new coiling process increases the flexibility of our coiled pipe even more.



Cost Effective

SharkBite PEX Pipe is substantially more cost effective than Copper pipe—SharkBite PEX Pipe costs a third of the price of Copper. SharkBite PEX Pipe is a fixed cost as prices don't fluctuate daily like Copper pipe.

PROUDLY AMERICAN MADE

SHARKBITE PEX – CERTIFICATIONS



NSF/ANSI 14
NSF/ANSI 61



ASTM F 877



AWWA C904



ASTM F 876



CSA B137.5



UL 1821

MADE IN THE USA

SharkBite PEX Pipe is a cost effective piping solution approved for use in both hot and cold plumbing installations. Meeting the highest chlorine resistance standards and utilizing the most energy efficient manufacturing processes, our PEX pipe is proudly produced in Alabama. We own our manufacturing process from start to finish, so every piece of SharkBite PEX Pipe is guaranteed from concept to delivery.

PEX pipe was introduced to North America in 1984 based on European market success, and was tested extensively for durability and material performance. All USA-installed PEX pipe must meet the qualification requirements as specified in the ASTM PEX Standards. SharkBite PEX Pipe can bend up to six times the outside diameter of the pipe—which is the maximum bend radius recommended by PEX pipe manufacturers.

SharkBite PEX Pipe can be used in a variety of applications including:

- Domestic plumbing
- Fire suppression systems (residential fire sprinklers)
- Municipal water service pipe for use in underground applications
- Radiant heating systems for suspended floor systems or in slab construction
- Snow and ice melt systems for sidewalks, driveways, entrances, and ramps
- Turf conditioning for greenhouses, golf courses, and sports fields
- Water reuse and reclamations systems

DISCOVER THE FLEXIBILITY OF SHARKBITE PEX PIPE.

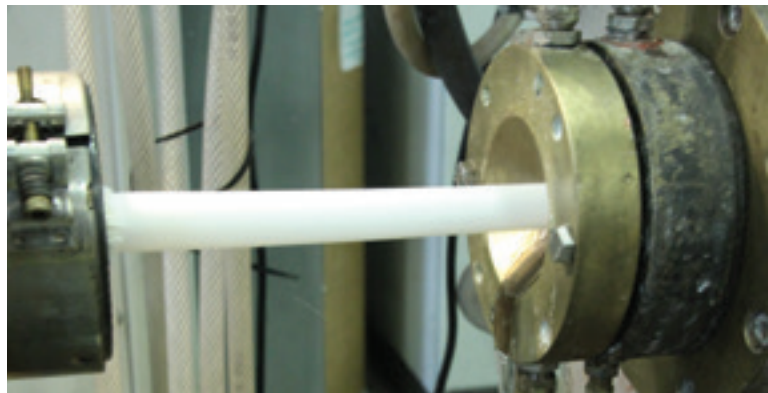

PRODUCT DESCRIPTION	PART NUMBER	PART NUMBER	PART NUMBER	PACK/ QTY	LIST PRICE
---------------------	-------------	-------------	-------------	--------------	------------

SECTION 4: SHARKBITE PEX PIPE

SharkBite PEX Pipe is a cross-linked polyethylene pipe for use in a wide range of residential and commercial plumbing applications. Manufactured without an oxygen barrier for potable water systems and with an oxygen barrier for radiant floor and hydronic heating applications. A repeating SharkBite imprint pattern provides a visual aid to determine if the pipe has been inserted all the way into the SharkBite push-to-connect fitting. This feature only works if the pipe is cut between the SharkBite imprint pattern.

APPROVALS: The SharkBite pipe with and without oxygen barrier is approved for use in all model codes in the US and Canada, for use in hydronic and potable water systems, and is certified to the following standards: ASTM F876, ASTM F877, CSA B137.5 and AWWA C904.

4-A: POTABLE WATER PEX PIPE

PEX PIPE (COILS)	WHITE	RED	BLUE		
1/4" (3/8" OD) 50'	U850W50			1	\$20.00
1/4" (3/8" OD) 100'	U850W100				\$40.00
3/8" 50'	U855W50			1	\$22.50
3/8" 100'	U855W100	U855R100	U855B100	1	\$45.00
1/2" 25'	U860W25W	U860R25W	U860B25W	1	\$12.50
1/2" 50'	U860W50W	U860R50W	U860B50W	1	\$25.00
1/2" 100'	U860W100W	U860R100W	U860B100W	1	\$50.00
1/2" 300'	U860W300W	U860R300W	U860B300W	1	\$150.00
1/2" 500'	U860W500W	U860R500W	U860B500W	1	\$250.00
1/2" 1000'	U860W1000W	U860R1000W	U860B1000W	1	\$500.00
3/4" 25'	U870W25W	U870R25W	U870B25W	1	\$22.50
3/4" 50'	U870W50W	U870R50W	U870B50W	1	\$45.00
3/4" 100'	U870W100W	U870R100W	U870B100W	1	\$90.00
3/4" 300'	U870W300W	U870R300W	U870B300W	1	\$270.00
3/4" 500'	U870W500W	U870R500W	U870B500W	1	\$450.00
1" 100'	U880W100W	U880R100W	U880B100W	1	\$160.00
1" 300'	U880W300W	U880R300W	U880B300W	1	\$480.00
1" 500'	U880W500W	U880R500W	U880B500W	1	\$800.00
1-1/4" 100'	U885W100			1	\$300.00
1-1/2" 100'	U890W100			1	\$450.00
2" 100'	U895W100			1	\$850.00
PEX PIPE (STRAIGHT LENGTHS)	WHITE	RED	BLUE		
1/4" (3/8" OD) 5'	U850W5			20	\$2.00
3/8" 5'	U855W5			10	\$2.25
3/8" 10'	U855W10			10	\$4.50
1/2" 2'	U860W2	U860R2	U860B2	60	\$2.00
1/2" 5'	U860W5	U860R5	U860B5	10	\$2.50
1/2" 10'	U860W10	U860R10	U860B10	10	\$5.00
1/2" 20'	U860W20	U860R20	U860B20	10	\$10.00
3/4" 2'	U870W2	U870R2	U870B2	30	\$3.60
3/4" 5'	U870W5	U870R5	U870B5	10	\$4.50
3/4" 10'	U870W10	U870R10	U870B10	10	\$9.00
3/4" 20'	U870W20	U870R20	U870B20	10	\$18.00
1" 5'	U880W5	U880R5	U880B5	5	\$8.00
1" 10'	U880W10	U880R10	U880B10	5	\$16.00

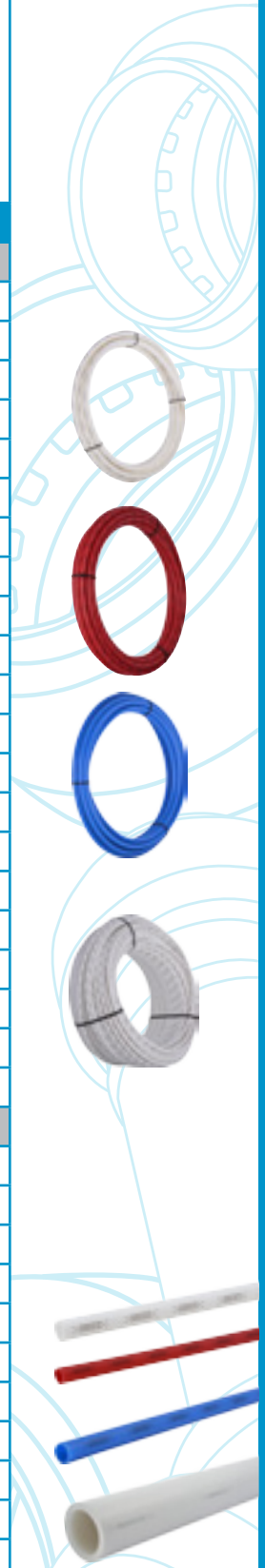

PRODUCT DESCRIPTION	PART NUMBER	PART NUMBER	PART NUMBER	PACK/ QTY	LIST PRICE
1" 20'	U880W20	U880R20	U880B20	5	\$32.00
1-1/4" 20'	U885W20			5	\$60.00
1-1/2" 20'	U890W20			5	\$90.00
2" 20'	U895W20			3	\$170.00

PRODUCT DESCRIPTION	PART NUMBER	PACK/ QTY	LIST PRICE
---------------------	-------------	--------------	------------

4-B: SPECIAL APPLICATION PEX PIPE

RECLAIMED WATER PEX PIPE (PURPLE COILS) FOR USE WITH NON-POTABLE WATER APPLICATIONS AND SHALL NOT BE INSTALLED IN UV-EXPOSED ENVIRONMENTS

RECLAIMED

SharkBite reclaimed water PEX is cross-linked polyethylene pipe for gray water, rainwater harvesting and reclaimed water systems only. Manufactured with a purple color background, the pipe meets color code requirements of national and state code bodies to clearly identify reclaimed water lines. SharkBite reclaimed water PEX is manufactured and available in 1/2" to 1".

1/2" 100'	U860P100	1	\$60.00
1/2" 300'	U860P300	1	\$180.00
3/4" 100'	U870P100	1	\$110.00
3/4" 300'	U870P300	1	\$330.00
1" 100'	U880P100	1	\$190.00
1" 300'	U880P300	1	\$570.00

OXYGEN BARRIER PEX PIPE (ORANGE COILS)

OXYGEN BARRIER

Use for radiant floor and hydronic heating applications. The oxygen diffusion barrier is applied to the exterior and limits oxygen permeation through the pipe wall in hydronic heating applications. This prevents corrosion of ferrous metal parts in the heating system.

3/8" 100'	U8550100	1	\$70.00
3/8" 300'	U8550300	1	\$210.00
3/8" 500'	U8550500	1	\$350.00
1/2" 100'	U8600100	1	\$70.00
1/2" 300'	U8600300	1	\$210.00
1/2" 500'	U8600500	1	\$350.00
1/2" 1000'	U86001000	1	\$700.00
5/8" 300'	U8650300	1	\$300.00
3/4" 100'	U8700100	1	\$130.00
3/4" 300'	U8700300	1	\$390.00
3/4" 500'	U8700500	1	\$650.00
3/4" 1000'	U87001000	1	\$1,300.00
1" 100'	U8800100	1	\$225.00
1" 300'	U8800300	1	\$675.00
1" 500'	U8800500	1	\$1,125.00

OXYGEN BARRIER PEX PIPE (ORANGE STRAIGHT LENGTHS)

OXYGEN BARRIER

1/2" 20'	U860020	10	\$14.00
3/4" 20'	U870020	10	\$26.00
1" 20'	U880020	5	\$45.00
1" 20'	U880020	5	\$45.00



SHARKBITE

PUSH-TO-CONNECT FITTINGS

- The SharkBite push-to-connect range is made from Lead Free DZR brass and all products were converted as of October 2012.
- The standard material versions of SharkBite push-to-connect fittings are no longer in production, but we do continue to offer a small range of 5/8" fittings in standard material, specifically intended for radiant heating applications. As a running change, these fittings will be converted to Lead Free in due course.
- Our SharkBite 2XL large Diameter fittings have been Lead Free since their introduction in February 2011.

SHARKBITE

PEX/BARB FITTINGS

- Our PEX/barb range is made from Lead Free DZR brass and all products were converted as of October 2012.
- We have also implemented an extended range of engineered polymer barb fittings.

LEAD FREE*



As of January 2014 a new Federal law came into effect that introduced a similar requirement across the whole country.

More information is available on our websites at:
www.cashacme.com
www.sharkbite.com

In this document, products are marked "Lead Free" or "Non-Potable" as applicable.

- "Lead Free" indicates that a product is suitable for use in an application that is anticipated or intended to deliver water for human consumption.
- "Non-Potable" designates that a product is only suitable for applications that are not anticipated or intended to deliver water for human consumption.

If a product is not marked "Lead Free" or "Non-Potable" it is either:

- Not designed to come into contact with water (e.g. tools, crimp rings, pipe hangers), or
- It is a replacement part or component for a valve or piece of Original Equipment, where it is necessary for the function of that valve or equipment to use the identical specification component with which it was originally designed and certified.

** A device is defined as Lead Free if its wetted surface has a weighted average lead content not exceeding 0.25%.*

LIMITED WARRANTY

SHARKBITE® AND CASH ACME® PRODUCTS

WHAT DOES THIS WARRANTY COVER?

Subject to conditions outlined in this statement, RWC (in the USA, Reliance Worldwide Corporation and in Canada, Reliance Worldwide Corporation (Canada) Inc.) warrants to owners of real property in the United States and Canada that SharkBite and Cash Acme products, when used and installed in accordance with the requirements set forth, shall be free from defects in material and workmanship for the applicable Warranty Period. This Limited Warranty is in effect for installations made after January 1, 2016 and is applicable to products installed in the country in which they were purchased.

Proof of purchase is required to validate the Warranty Period. If proof of purchase is not available, the Warranty Period commencement shall default to the date of manufacture for each product. If the product suspected of a defect does not have a clear date of manufacture on it, a proof of purchase will be required.

WHAT ARE THE CONDITIONS OF THIS WARRANTY?

1. All products must be installed in accordance with all then applicable codes, good plumbing practice, in accordance with any local, state, provincial or federal requirements, and installed in a potable water or radiant heating application unless a non-potable water service is specifically allowed for in the pertinent product literature.
2. The installer must use construction techniques compliant with then applicable codes to install the product and use the product within the design parameters specified in any installation guidelines and technical notes for the applicable system. This shall include field pressure testing prior to concealing with concrete or by other means and wrapping any brass fitting when buried. Failure to install RWC products according to manufacturer's installation instruction will void all applicable warranties and may result in severe water damage.
3. Products must at all times be used in a manner consistent with their intended use and be used in installations and environments acceptable to their material and design specifications, including not being installed in a system that may operate at temperatures or at pressures that exceed the approved ratings which can be found on the product, packaging or installation instructions.
4. Additional product specific conditions of this Limited Warranty and the Warranty Period are documented in the section entitled "HOW LONG DOES THE LIMITED WARRANTY COVERAGE LAST AND WHAT OTHER SPECIFIC CONDITIONS EXIST FOR EACH PRODUCT?". A condition for SharkBite Connection Systems is that the product must be installed by a licensed professional plumbing contractor.
5. Without limiting the foregoing, this Limited Warranty does not apply and you do not have a right of reimbursement if the product failure or resulting damage is caused by: (a) evidence of tampering, mishandling, neglect, abuse, accidental damage, freeze damage (it is expressly understood that failure as a result of any freezing fluids within the pipes does not constitute a defect in material or workmanship and shall not be covered by this warranty) or unauthorized modifications or repairs that cause damage to warranted products; (b) exposure to harmful, unauthorized, or unanticipated chemicals or substances or corrosive water conditions; (c) exposure to ultraviolet light; (d) faulty installation including failure to follow proper burial instructions; (e) damage from abnormal operating conditions including exposure pressures and temperatures beyond the specified operating range; (f) failure to properly test and pass common testing methods (including pressure testing) after the installation and before the product or system is put in service; (g) components not manufactured or sold by RWC; or (h) acts of nature such as earthquakes, fire, flood or lightning.
6. Although RWC provides a plumbing system to facilitate a complete installation, other manufacturers pipe and/or fittings may be installed in any given installation provided manufacturing of the pipe and/or fittings demonstrates compliance with the applicable ASTM/CSA standards, and the product has been certified by a recognized third-party testing agency. The RWC product in the given installation will continue to be covered under this Limited Warranty although limits on Warranty Period may apply. RWC will be responsible only for proven defects in material or workmanship in RWC products. Problems in products manufactured by another company should be reported to that manufacturer.

HOW DO YOU GET SERVICE?

In order to be eligible for service under this Limited Warranty you must return the defective product to RWC for inspection and testing within thirty (30) days after detection of alleged failure or defect occurring within applicable Warranty Period (with shipping charges prepaid) to the original place of purchase. If the alleged

defect involves a connection or joint with a RWC product, the fitting must be returned with a section of the pipe still inserted. You must include the model number of the product (if available), the original date of purchase, proof of purchase and the nature of the alleged product failure or defect. Products returned without shipping charges prepaid will be refused. For questions or inquiries, in the U.S. call 1(877)700-4242 and in Canada 1(888)820-0120.

WHAT WILL RWC DO?

If, after inspection, we find that a product covered by this Limited Warranty has failed due to a defect in material or workmanship during the specified Warranty Period, we will repair or replace, at our sole option, free of charge, the defective product during normal working hours and through a place of business as determined by RWC.

Notwithstanding anything to the contrary in this Limited Warranty, if RWC determines that any damages to the real property in which a defective product was installed were the direct result of a leak or failure caused by a defect in material or workmanship in any RWC product covered by this Limited Warranty and occurring within the first ten years after date of purchase or during the applicable Warranty Period, whichever is shorter, and if reasonable steps were taken to promptly limit or stop the effects of such leak or failure as soon as it was discovered, then RWC will reimburse the property owner for the reasonable costs of repairing or replacing such damaged real property to include flooring, drywall and painting and other real property damaged by the leak directly caused by the allegedly defective RWC product. Except as specified above or otherwise specifically authorized in writing by RWC, RWC shall not pay for any costs or expenses for transportation, relocation, labor, repairs or any other work associated with removing and/or returning failed or defective products or installing replacement products.

This shall constitute the sole and exclusive remedy for any defective product.

WHAT DOES THIS LIMITED WARRANTY NOT COVER?

RWC shall not be responsible for any other incidental, indirect, contingent, special or consequential damages, including without limitation, economic loss, lost profits or the cost of repairing or replacing other property which is damaged if these warranted products do not work properly, other costs resulting from labor charges, delays, vandalism, negligence, fouling caused by foreign material, damage from adverse water conditions, adverse chemical environments, or any other circumstances over which RWC has no control. This limitation applies even if RWC could have foreseen or has been advised of the possibility of these damages. This Limited Warranty shall be invalidated by any abuse, misuse, misapplication or improper installation of the product. Any remaining warranty coverage may not be assigned or transferred after the period ending ten years following the installation. RWC does not guarantee or in any way warrant the integrity or workmanship of the contractor/installer.

MISCELLANEOUS

Some States/Provinces do not allow limitations on how long an implied warranty lasts, and some States/Provinces do not allow the exclusion or limitation of incidental or consequential damages. Therefore, the above limitations may not apply to you. This Limited Warranty gives you specific legal rights, and you may have other rights that vary from State/Province to State/Province. You should consult applicable State/Provincial laws to determine your rights.

SO FAR AS IS CONSISTENT WITH APPLICABLE STATE/ PROVINCIAL/ FEDERAL LAW, THE EXPRESS WARRANTY SET FORTH HEREIN IS THE ONLY WARRANTY GIVEN BY RWC WITH RESPECT TO THE SHARKBITE® AND CASH ACME® PRODUCTS AND RWC MAKES NO OTHER WARRANTIES, EXPRESSED OR IMPLIED, AND HEREBY SPECIFICALLY DISCLAIMS ALL OTHER WARRANTIES, EXPRESSED OR IMPLIED, INCLUDING BUT NOT LIMITED TO THE IMPLIED WARRANTIES OF MERCHANTABILITY AND FITNESS FOR A PARTICULAR PURPOSE.

This Limited Warranty and any claims arising from breach of contract, breach of warranty, tort, or any other claim arising from sale or use of RWC's products shall be governed and construed under the laws of the State of Georgia. No action on the part of RWC under this Limited Warranty shall be construed as an admission of liability of that the product is not fit for its intended use.

HOW LONG DOES THE LIMITED WARRANTY COVERAGE LAST AND WHAT OTHER SPECIFIC CONDITIONS EXIST FOR EACH PRODUCT?

CLASSIFICATION	PRODUCT CATEGORY	LIMITED WARRANTY PERIOD	CONDITIONS
SharkBite Connection Systems	SharkBite Brass and Poly PEX Barb Fittings in conjunction with SharkBite PEX Pipe and SharkBite Rings/Clamps	Twenty-Five (25) Years	System must be installed by a licensed professional plumbing contractor and include: <ul style="list-style-type: none"> • SharkBite PEX Pipe Only - ASTM F876/CSA B137.5 • SharkBite Copper Crimp Rings – ASTM F1807 or F2159 • Stainless Steel Clamp Rings – ASTM F2098
SharkBite and Cash Acme Products	SharkBite Universal Push-to-Connect Fittings and SharkBite 2XL Large Diameter Push-to-Connect Fittings in Application with Copper, PEX, CPVC and/or PE-RT	Twenty-Five (25) Years	Must be used with: <ul style="list-style-type: none"> • Copper–ASTM B 88 hard drawn copper tube K, L, and M • PEX–ASTM F876/CSA B137.5 • CPVC–ASTM D2846 or CSA B137.6 • PE-RT–ASTM F2769
	SharkBite Universal Push-to-Connect Fittings and SharkBite 2XL Large Diameter Push-to-Connect Fittings in Application with HDPE	Five (5) Years	Must be used with: <ul style="list-style-type: none"> • HDPE SDR-9 ASTM D2737
	SharkBite PEX Pipe	Twenty-Five (25) Years	Must be used with: <ul style="list-style-type: none"> • ASSE 1061, ASTM F1807, ASTM F2098, and/or ASTM F2159 fittings
	SharkBite Brass PEX Barb Fittings/ Copper Manifold	Five (5) Years	Must be used with Non-SharkBite PEX Pipe and Clamps/Rings that conform to: <ul style="list-style-type: none"> • PEX – ASTM F876/CSA B137.5 • Copper Crimp Rings – ASTM F1807 • Stainless Steel Clamp Rings – ASTM F2098
	SharkBite Poly PEX Barb Fittings	Five (5) Years	Must be used with Non-SharkBite PEX Pipe and Clamps/Rings that conform to: <ul style="list-style-type: none"> • PEX – ASTM F876/CSA B137.5 • Copper Crimp Rings – ASTM F2159 • Stainless Steel Clamp Rings – ASTM F2098
	SharkBite Tools	One (1) Year	From date of purchase; used in accordance with instructions
	SharkBite and Cash Acme Thermostatic Mixing Valves	Five (5) Years	Must be installed per installation instructions
	Other SharkBite and Cash Acme Valves	Two (2) Years	Must be installed per installation instructions
	SharkBite Accessories (Ball Valves, Supply Hoses, Supply Stops, Supply Valve Box Systems, Kits, Manifolds, etc.)	Two (2) Years	Must be installed per installation instructions

Part Number	Page	Part Number	Page	Part Number	Page	Part Number	Page	Part Number	Page
22182-0000LF	13	23101CP100	19	24983	9	SB115450F	4	U3008LF	3
22185-0000LF	13	23102	19	24984	9	SB115450M	4	U308LF	5
22186-0000LF	13	23102CP25	19	24985	9	SBBV35	13	U3016FLEX18LF	9
22187-0000LF	13	23102CP100	19	24986	9	SBBV41	13	U3016LF	3
22222-0000LF	13	23103	19	24987	9	SBBV54	13	U3020LF	3
22223-0000LF	13	23103CP25	19	25024	11	SBDC35	12	U3068FLEX12LF	8
22304-0000LF	13	23103CP100	19	25087	11	SBDC354154	12	U3068FLEX15LF	8
22305-0000LF	13	23104	19	25088	11	SBDC41	12	U3068FLEX18BVLV	8
22306-0000LF	13	23104CP25	19	25096	11	SBDC54	12	U3068FLEX18LF	8
22441LF	11	23220	19	25097	11	SBG03	11	U3068FLEX24LF	8
22461LF	18	23221	19	25098	11	SRTL35	12	U3086FLEX24LF	9
22462LF	18	23251	20	25099	11	SRTL41	12	U3088FLEX12LF	8
22463LF	18	23336-0000LF	9	25401	18	SRTL54	12	U3088FLEX15LF	8
22486LF	11	23337-0000LF	9	25404	11	SS3068FLEX18BV	9	U3088FLEX18BVLV	8
22604LF	11	23358-0045	12	25406	12	SS3086FLEX24LF	8	U3088FLEX18LF	8
22630LF	10	23382LF	18	RM22716	18	SS3088FLEX18BV	9	U3088FLEX24LF	8
22631LF	10	23383	20	RM22720	18	SS3088FLEX18LF	8	U314LF	5
22632LF	10	23489	9	RM22724	18	SS3088FLEX24LF	8	U332LF	5
22633LF	10	23490	9	SB0135	3	U004LF	3	U334LF	5
22675-0045	12	23807-0045	12	SB013528	3	U006LF	3	U335LF	5
22783	18	23808-0045	12	SB0141	3	U008LF	3	U3358LF	10
22784	18	23893-0045	12	SB014128	3	U009LF	3	U3362LF	6
22785	18	23894-0045	12	SB014135	3	U012	7	U3370LF	6
22786	18	23896-0060	12	SB0154	3	U016LF	3	U340LF	5
22787	18	23945-0060	12	SB015441	3	U020LF	3	U3482LF	6
22788	18	23955-0045	12	SB0235	4	U050LF	3	U3486LF	6
22789	18	23956-0045	12	SB0241	4	U057	7	U351LFA	10
22790	18	24383-0045	12	SB0254	4	U058LF	3	U3523LF	10
22791	18	24384-0045	12	SB0335	6	U060LF	3	U3524LF	10
22995LF	10	24436	11	SB03353516	6	U066LF	4	U3525LF	10
22996LF	10	24437	11	SB03353522	6	U068LF	4	U3531LF	10
22997LF	10	24438	11	SB03353528	6	U070LF	4	U3537LF	10
22998LF	10	24439	11	SB0341	6	U072LF	4	U358LF	5
23036-0000LF	9	24440	11	SB03414122	6	U086LF	6	U359LF	5
23037-0000LF	9	24441	11	SB03414128	6	U088LF	4	U360LF	5
23048-0000LF	9	24442	11	SB03414135	6	U092LF	4	U362LF	5
23049-0000LF	9	24443	11	SB0354	6	U094LF	4	U363LF	5
23050	19	24444	11	SB03545428	6	U110LF	4	U364LF	5
23051	19	24445	11	SB03545435	6	U116LF	4	U366	7
23053	19	24449-0045	12	SB03545441	6	U118LF	4	U370LF	5
23054	19	24504	13	SB0435	6	U120LF	4	U3712	12
23055	20	24505	13	SB0441	6	U126	7	U374LF	5
23056LF	18	24529	13	SB0454	6	U134LF	4	U4008LF	7
23057LF	18	24530	13	SB0535	4	U138LF	4	U4016LF	7
23058LF	18	24615-0000LF	13	SB0541	4	U139LF	4	U412LF	5
23059LF	18	24616-0000LF	13	SB0554	4	U140LF	4	U416LF	5
23060LF	18	24617-0000LF	13	SB0635	3	U142LF	4	U4358LF	10
23061LF	18	24680	9	SB0641	3	U2008-0000LF	13	U444LF	5
23062LF	18	24731LF	9	SB0654	3	U2016-0000LF	13	U4482LF	6
23063LF	18	24732LF	9	SB0735	4	U2020-0000LF	13	U454LF	5
23064LF	18	24733LF	9	SB0741	4	U2276LF	5	U462LF	6
23066LF	18	24734LF	9	SB0754	4	U244LF	4	U464LF	6
23065	19	24735LF	13	SB0835	5	U246LF	4	U512LF	6
23067LF	16	24736LF	13	SB08353516	5	U248LF	4	U514LF	6
23068LF	16	24737LF	13	SB08353522	5	U249LF	5	U516	7
23069	18	24930	10	SB08353528	5	U252	7	U518LF	6
23070	18	24931	10	SB0841	5	U256LF	4	U520LF	6
23071A10	19	24932	10	SB08414122	5	U260LF	4	U701	20
23072A10	19	24933	10	SB08414128	5	U272LF	5	U702	11
23073A10	19	24934	10	SB08414135	5	U273	7	U706	12
23074A10	19	24935	10	SB0854	5	U274LF	5	U708	12
23075A10	19	24936	10	SB08545428	6	U276LF	5	U710	12
23076A10	19	24937	10	SB08545435	6	U278LF	5	U711	12
23080	20	24938	10	SB08545441	6	U280LF	5	U712	12
23081	20	24939	10	SB113532F	4	U281LF	5	U713	12
23100	20	24940	10	SB113532M	4	U286LF	5	U714	12
23101	19	24946	9	SB114140F	4	U3001A	11	U715	12
23101CP25	19	24947	9	SB114140M	4	U3008FLEX18LF	9	U719LF	6

Part Number	Page	Part Number	Page	Part Number	Page	Part Number	Page	Part Number	Page
U721LF	6	U8700300	23	UC118LF	14	UC961	20	UP412	17
U722LF	6	U8700500	23	UC120LF	14	UCF12128A	17	UP414	17
U724LF	6	U87001000	23	UC134LF	14	UCF12128H	17	UP415	17
U766LF	4	U870P100	23	UC138LF	14	UCF12128V	17	UP416	17
U772LF	4	U870P300	23	UC139LF	14	UCF128L	17	UP444	17
U782LF	9	U870R2	22	UC140LF	14	UCF128R	17	UP454	17
U850W5	22	U870R5	22	UC142LF	14	UCF128S	17	UP514	17
U850W50	22	U870R10	22	UC246LF	14	UCF128U	17	UP518	17
U850W100	22	U870R20	22	UC248LF	14	UCF16128H	17	UP520	17
U8550100	23	U870R25W	22	UC256LF	14	UCF16128V	17	UP526	17
U8550300	23	U870R50W	22	UC260LF	14	UCF16168H	17	UP527	17
U8550500	23	U870R100W	22	UC272LF	15	UCF16168V	17	UP532	17
U855B100	22	U870R300W	22	UC273LF	15	UCF168L	17		
U855R100	22	U870R500W	22	UC274LF	15	UCF168R	17		
U855W5	22	U870W2	22	UC278LF	15	UCF168U	17		
U855W10	22	U870W5	22	UC280LF	15	UF12128A	8		
U855W50	22	U870W10	22	UC286LF	15	UF12128H	8		
U855W100	22	U870W20	22	UC334LF	15	UF12128V	8		
U860B2	22	U870W25W	22	UC340LF	15	UF128L	8		
U860B5	22	U870W50W	22	UC342LF	15	UF128R	8		
U860B10	22	U870W100W	22	UC360LF	15	UF128S	8		
U860B20	22	U870W300W	22	UC362LF	15	UF128U	8		
U860B25W	22	U870W500W	22	UC363LF	15	UF16128H	8		
U860B50W	22	U880B5	22	UC364LF	15	UF16128V	8		
U860B100W	22	U880B10	23	UC370LF	15	UF16168H	8		
U860B300W	22	U880B20	23	UC374LF	15	UF16168V	8		
U860B500W	22	U880B100W	22	UC4006LF	16	UF168L	8		
U860B1000W	22	U880B300W	22	UC4008LF	16	UF168R	8		
U860O20	23	U880B500W	22	UC4016LF	16	UF168U	8		
U860O100	23	U880O20	23	UC408LF	15	UFH034	20		
U860O300	23	U880O100	23	UC412LF	15	UIP120	7		
U860O500	23	U880O300	23	UC413LF	15	UIP134	7		
U860O1000	23	U880O500	23	UC414LF	15	UIP140	7		
U860P100	23	U880P100	23	UC415LF	15	UIP3008	7		
U860P300	23	U880P300	23	UC416LF	15	UIP3016	7		
860R2	22	U880R5	22	UC417LF	15	UIP3020	7		
860R5	22	U880R10	23	UC418LF	15	UIP363	7		
860R10	22	U880R20	23	UC434LF	15	UIP364	7		
860R20	22	U880R100W	22	UC444LF	15	UIP371	7		
U860R25W	22	U880R300W	22	UC452LF	15	UIP372	7		
U860R50W	22	U880R500W	22	UC454LF	15	UIP375	7		
U860R100W	22	U880W5	22	UC512LF	16	UIP376	7		
U860R300W	22	U880W10	23	UC514LF	16	UIP4008	7		
U860R500W	22	U880W20	23	UC518LF	16	UIP4016	7		
U860R1000W	22	U880W100W	22	UC520LF	16	UIP4020	7		
U860W2	22	U880W300W	22	UC526LF	15	UIP710	7		
U860W5	22	U880W500W	22	UC527LF	15	UIP712	7		
U860W10	22	U885W20	23	UC528LF	16	UIP714	7		
U860W20	22	U885W100	22	UC529LF	15	UP008	16		
U860W25W	22	U890W20	23	UC530LF	15	UP016	16		
U860W50W	22	U890W100	22	UC531LF	15	UP020	16		
U860W1000W	22	U895W20	23	UC532LF	15	UP058	16		
U860W300W	22	U895W100	22	UC534LF	15	UP060	16		
U860W500W	22	UC006LF	14	UC594LF	15	UP120	16		
U860W1000W	22	UC008LF	14	UC600LF	14	UP134	16		
U8650300	23	UC009LF	14	UC605LF	14	UP138	16		
U870B2	22	UC012LF	14	UC606LF	14	UP140	16		
U870B5	22	UC016LF	14	UC607LF	14	UP248	16		
U870B10	22	UC020LF	14	UC608LF	14	UP256	16		
U870B20	22	UC057LF	14	UC609LF	14	UP260	16		
U870B25W	22	UC058LF	14	UC626LF	15	UP274	16		
U870B50W	22	UC060LF	14	UC628LF	15	UP280	16		
U870B100W	22	UC068LF	14	UC952	19	UP360	16		
U870B300W	22	UC072LF	14	UC953	19	UP362	16		
U870B500W	22	UC088LF	14	UC954	19	UP370	16		
U870O20	23	UC094LF	14	UC955	19	UP374	16		
U870O100	23	UC116LF	14	UC956	19	UP408	17		



CERTIFICATIONS

The SharkBite push-to-connect fittings have been certified and listed to ASSE 1061 and NSF/ANSI 61. The SharkBite push-to-connect fittings are listed by IAPMO and are certified for potable and hydronic heating water distribution (Note: Glycol mixture for hydronics is acceptable up to and including 100%). The SharkBite push-to-connect fittings have been certified for underground applications and as a manufactured joint without access panels and they meet UPC, IPC and cUPC requirements. Any SharkBite fitting listed as Lead Free is compliant with NSF/ANSI 372. Please consult with local plumbing codes concerning specific applications.

The SharkBite pipe without oxygen barrier is approved for all model codes in the US and Canada for use in potable water systems and is certified to the following standards: ASTM F 876, ASTM F 877, CSA B137.5 and AWWA C904.

The SharkBite pipe with oxygen barrier is approved for use in all model codes in the US and Canada for use in hydronic and potable water systems and is certified to the following standards: ASTM F 876, ASTM F 877, CSA B137.5 and AWWA C904.

Note: The SharkBite push-to-connect fittings are not approved for use with chrome-plated pipe. SharkBite Polybutylene couplings are designed to work with ASTM D3309 spec polybutylene, do not install onto damaged or decayed PB pipe.



Reliance Worldwide Corporation



MANUFACTURED AND DISTRIBUTED BY RELIANCE WORLDWIDE CORPORATION