

**Ultima™ Manual
Urinal Flush Valve, Piston-Type
3/4" Top Spud, 0.5 gpf**

MODEL NUMBERS

**6045.051
7015.051**

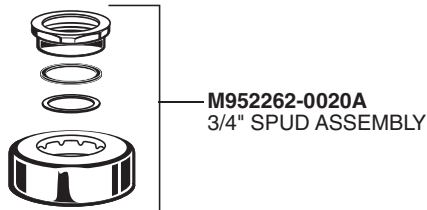
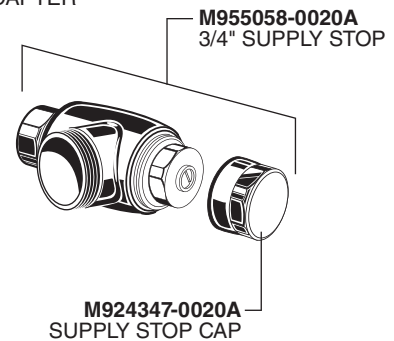
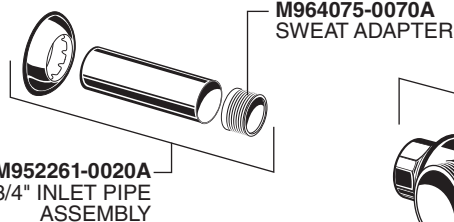
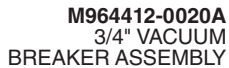
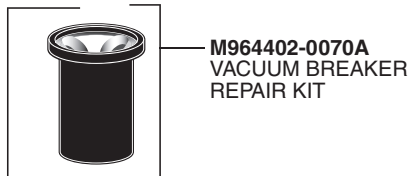
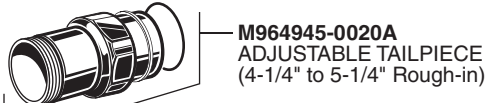
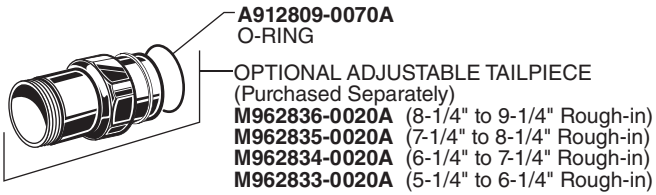
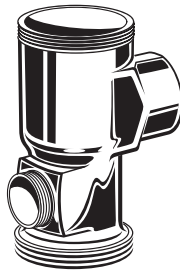
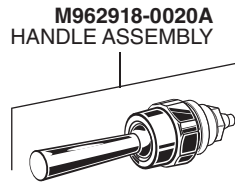
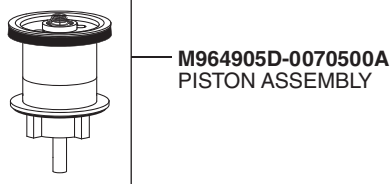
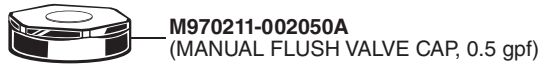

PART OF **LIXIL**



HOT LINE FOR HELP
For toll-free information and answers to your questions, call:
 (844) CRT-TEAM / (844) 278-8326
 Weekdays 8:00 a.m. to 6:00 p.m. EST
 IN MEXICO 01-800-839-1200
 IN CANADA 1-800-387-0369 (TORONTO 1-905-306-1093)
 Weekdays 8:00 a.m. to 7:00 p.m. EST

Product names listed herein are trademarks of AS America, Inc. ©2019

To learn more about American Standard Selectronic® Products visit our website at:
www.americanstandard-us.com or e-mail us at: CRTEAM@lixilamericas.com