



GE Evolve[®]

LED Roadway Lighting

ERL1-ERLH-ERL2



current
powered by GE



GE Evolve® LED Roadway Lighting ERL1-ERLH-ERL2



The **Evolve®** LED Roadway Luminaire is optimized for customers requiring a LED solution for local, collector and major roadways. GE's unique reflective optics are designed to optimize application efficiency and minimize glare. The modern design incorporates the heat sink directly into the unit for heat transfer to prolong LED life. This reliable unit has a 100,000 hour design life, significantly reducing maintenance needs and expense over the life of the fixture. This efficient solution lowers energy consumption compared to a traditional HID fixture for additional operating cost savings.

Features:

- Optimized roadway photometric distributions
- **Evolve®** light engine consisting of reflective technology designed to optimize application efficiency and minimize glare
- 70 CRI at 2700K, 3000K and 4000K typical.
- -40°C to 50°C UL Ambient Typical.
- ULOR = 0 (zero uplight)
- Designed & Assembled in USA

Applications:

- Local Roadways
- Collector Roadways
- Major Roadway/Streets



Compatible with **LightGrid** Outdoor Wireless Control System



To learn more about **GE Evolve® LED Roadway Lighting**, go to: www.currentbyge.com

GE Evolve®

LED Roadway Lighting

ERL1-ERLH-ERL2



Project name _____

Date _____

Type _____

Typical Specifications: ERL1-ERLH-ERL2

LED & Optical

- **Output Range:** 1900 – 30000 lm
- **Photometric Options:** Type II Narrow, Type II Wide, Type III, Type IV
- **System Efficacy:** 100 - 145 LPW
- **CCT:** 2700K, 3000K, 4000K; LEDs @ 70 CRI

Lumen Maintenance Tables

Projected Lxx per IES TM-21 at 25°C for reference:

ERL1 LUMEN OUTPUT CODES	LXX(10K)@HOURS		
	25,000 HR	50,000 HR	60,000 HR
02,03,04,05,06	L96	L95	L94
07,08,09	L95	L91	L89
10	L89	L80	L76

ERLH LUMEN OUTPUT CODES	LXX(10K)@HOURS		
	25,000 HR	50,000 HR	60,000 HR
10, 11	L97	L96	L96
13, 14	L95	L93	L92
15, 16	L94	L91	L91

ERL2 LUMEN OUTPUT CODES	LXX(10K)@HOURS		
	25,000 HR	50,000 HR	60,000 HR
16, 18, 19, 21, 23	L96	L94	L95
25, 27, 28	L95	L93	L92
30	L94	L91	L90

Note: Projected Lxx based on LM80 (10,000 hour testing). Accepted industry tolerances apply to initial luminous flux and lumen maintenance measurements.

Electrical

- **Input Voltage:** 120-277 volt and 347-480 volt
- **Input Frequency:** 50/60Hz
- **Power Factor (PF)*:** >90%
- **Total Harmonic Distortion (THD)*:** <20%

*Power factor and THD tolerance exceptions: ERL1 "02" Lumen output: PF and THD within tolerances above only at 120 volt. ERL1 "03" Lumen output: @120 volt PF~0.89; @ 480 volt THD~26% ERL1 "04" Lumen output: @480 volt THD~22%

Ratings

- **Surge Protection:** per ANSI C136.2-2015: (Driver Internal):
 - 6kV/3kA "Basic: (120 Strikes)" - Standard on ERL1 (02-06)
 - 10kV/5kA "Enhanced: (40 Strikes)" - Standard on ERL1 (07 - 10), ERLH, ERL2
- **(Additional Separate Secondary SPD)**
 - 10kV/5kA "Enhanced: (40 Strikes)" - Option "R"
 - 20kV/10kA "Elevated" (40 Strikes) - Option "T"
- **Safety:** UL/cUL Listed. UL 1598 listed, suitable for wet locations (UL) (UL)
- **Environmental:** Compliant with the materials restrictions of RoHS
- **EMI:** Title 47 CFR Part 15 Class A
- **Vibration:** 3G per ANSI C136.31-2010
- LM-79 testing in accordance with IESNA Standards
- Std. Optical enclosure rated per ANSI C136.25-2009:
 - ERL1/ERLH/ERL2 = IP65, Optional: IP66

Operating Temperature:

PRODUCT ID	LUMEN OUTPUT	AMBIENT READING
ERL1	02-10	-40°C to 50°C
ERLH	10-11, 13	-40°C to 50°C
ERLH	14-16	-40°C to 45°C
ERL2	16-28	-40°C to 50°C
ERL2	30	-40°C to 45°C

Delayed start may be experienced < -35°C

Construction & Finish

- **Housing:**
 - Die Cast Enclosure
 - Casting-integral heat sink for maximum heat transfer
- **Lensing:** Impact resistant tempered glass, standard
- **Paint:** Corrosion resistant polyester powder painted, minimum 2.0 mil. thickness.
 - Standard Colors: Dark Bronze, Black, & Gray
 - RAL & custom colors available
 - Optional coastal finish available.
- **Weight:** 12.4lbs (5.6kg) – 24lbs (10.9kg)

Warranty

- **System Warranty:** 5 Year Standard, 10 Year Optional

Controls

- **Dimming:**
 - Standard: 0-10V; Optional: DALI (120-277V Only)
- **Sensors:**
 - Photo electric sensors (PE) available.
- LightGrid™ compatible

Mounting

- Slipfitter with +/- 5 degree of adjustment for leveling.
- Integral die cast mounting pipe stop.
- Adjustable for 1.25 in. or 2 in. mounting pipe.

Suggested HID Replacement Lumen Levels

- ~4,000–5,000 lumens to replace 100W HPS Cobra-head
- ~7,000–8,800 lumens to replace 150W HPS Cobra-head
- ~8,500–11,500 lumens to replace 200W HPS Cobra-head
- ~11,500–14,000 lumens to replace 250W HPS Cobra-head
- ~21,000–30,000 lumens to replace 400W HPS Cobra-head

Note: Actual replacement lumens may vary based upon mounting height, pole spacing, design criteria, etc.

PREVIOUS	DESCRIPTION	CURRENT	DESCRIPTION
A1, B1	Extra Narrow/Narrow Asymmetric	A3	Type II Narrow
C1, E1	Asymmetric Short/Medium	B3	Type II Wide
D1, G1	Asymmetric Forward/Extra Wide	C3	Type III
F1	Asymmetric Wide	D3	Type IV
		E3	Type II Enhanced Back Light

**The information above is designed to provide a guideline to select the correct luminaire for a roadway application. The best and most accurate way to ensure the proper design is to do a lighting layout Utilizing AGI.



International Dark Sky Association listed. 2700K or 3000K must be selected to meet IDA certification and approval.

GE Evolve®

LED Roadway Lighting

ERL1-ERLH-ERL2



Project name _____
 Date _____
 Type _____

ERL 1

PROD. ID	VOLTAGE	LUMEN OUTPUT	DISTRIBUTION*	CCT	CONTROLS	COLOR	OPTIONS
E = Evolve	0 = 120-277V*	02 *	A3 = Type II Narrow	27 = 2700K <>	A = ANSI C136.41 7-pin	GRAY = Gray	A = 4 Bolt Slipfitter †
R = Roadway	1 = 120	03	B3 = Type II Wide	30 = 3000K <>	D = ANSI C136.41 7-pin with Shorting Cap	BLCK = Black	F = Fusing
L = Local	2 = 208	04	C3 = Type III	40 = 4000K	E = ANSI C136.41 7-pin with non-Dimming PE Control.*	DKBZ = Dark Bronze	G = Internal Bubble Level
1 = Single Module	3 = 240	05	D3 = Type IV	<> Select 2700K or 3000K CCT for IDA approved units.	*PE Control Only available for 120-277V or 480V Discrete. Not available for 347-480V or 347V Discrete.		I = IP66 Optical
	4 = 277	06	E3 = Type II Enhanced Back Light				L = Tool-Less Entry
	5 = 480	07	See Table				R = Secondary 10kV/5kA SPD
	D = 347	08	*Nominal IES Type classing subject to typical variation, individual units may differ.				T = Secondary 20kV/10kA SPD
	H = 347-480*#	09					U = DALI Programmable +^
	* Not available with Fusing. Must choose a discrete voltage with F option. # Not available with E controls option.	10					V1 = Variable Output via Field Adjustable Module**
							X = Single Package #
							Y = Coastal Finish*
							XXX = Special Options
							† Contact manufacturer for Lead-Time.
							# "X" option provides single pack box per fixture. Std Packaging = 20 units per Magna pak container.
							* Recommended for installations within 750 ft. from the coast. Contact Factory for Lead-Time.
							+ Compatible with LightGrid 2.0 nodes.
							^ Not available in 347V, 480V or 347-480V for Lumen Output Levels 07, 08, 09, and 10.
							** Not available with DALI (U) option.

LUMEN OUTPUT	DISTRIBUTION	TYPICAL INITIAL LUMENS			TYPICAL SYSTEM WATTAGE		BUG RATING			IES FILE NUMBER					
		4000K	3000K	2700K	120-277V	347-480V	4000K	3000K	2700K	4000K	3000K	2700K	120-277V	347-480V	120-277V
02	A3	2000	1900	1900	14	N/A	B1-U0-G1	B1-U0-G1	B1-U0-G1	ERL1_02A340_-120VIES	N/A	ERL1_02A330_-120VIES	N/A	ERL1_02A327_-120VIES	N/A
	B3						B1-U0-G1	B1-U0-G1	B1-U0-G1	ERL1_02B340_-120VIES	N/A	ERL1_02B330_-120VIES	N/A	ERL1_02B327_-120VIES	N/A
	C3						B1-U0-G1	B1-U0-G1	B1-U0-G1	ERL1_02C340_-120VIES	N/A	ERL1_02C330_-120VIES	N/A	ERL1_02C327_-120VIES	N/A
	D3						B0-U0-G1	B0-U0-G1	B0-U0-G1	ERL1_02D340_-120VIES	N/A	ERL1_02D330_-120VIES	N/A	ERL1_02D327_-120VIES	N/A
	E3						B1-U0-G1	B1-U0-G1	B1-U0-G1	ERL1_02E340_-120VIES	N/A	ERL1_02E330_-120VIES	N/A	ERL1_02E327_-120VIES	N/A
03	A3	3000	2900	2800	22	26	B1-U0-G1	B1-U0-G1	B1-U0-G1	ERL1_03A340_-120-277VIES	ERL1_03A340_-347-480VIES	ERL1_03A330_-120-277VIES	ERL1_03A330_-347-480VIES	ERL1_03A327_-120-277VIES	ERL1_03A327_-347-480VIES
	B3						B1-U0-G1	B1-U0-G1	B1-U0-G1	ERL1_03B340_-120-277VIES	ERL1_03B340_-347-480VIES	ERL1_03B330_-120-277VIES	ERL1_03B330_-347-480VIES	ERL1_03B327_-120-277VIES	ERL1_03B327_-347-480VIES
	C3						B1-U0-G1	B1-U0-G1	B1-U0-G1	ERL1_03C340_-120-277VIES	ERL1_03C340_-347-480VIES	ERL1_03C330_-120-277VIES	ERL1_03C330_-347-480VIES	ERL1_03C327_-120-277VIES	ERL1_03C327_-347-480VIES
	D3						B1-U0-G1	B1-U0-G1	B1-U0-G1	ERL1_03D340_-120-277VIES	ERL1_03D340_-347-480VIES	ERL1_03D330_-120-277VIES	ERL1_03D330_-347-480VIES	ERL1_03D327_-120-277VIES	ERL1_03D327_-347-480VIES
	E3						B1-U0-G1	B1-U0-G1	B1-U0-G1	ERL1_03E340_-120-277VIES	ERL1_03E340_-347-480VIES	ERL1_03E330_-120-277VIES	ERL1_03E330_-347-480VIES	ERL1_03E327_-120-277VIES	ERL1_03E327_-347-480VIES
04	A3	4000	3900	3800	31	34	B1-U0-G1	B1-U0-G1	B1-U0-G1	ERL1_04A340_-120-277VIES	ERL1_04A340_-347-480VIES	ERL1_04A330_-120-277VIES	ERL1_04A330_-347-480VIES	ERL1_04A327_-120-277VIES	ERL1_04A327_-347-480VIES
	B3						B1-U0-G1	B1-U0-G1	B1-U0-G1	ERL1_04B340_-120-277VIES	ERL1_04B340_-347-480VIES	ERL1_04B330_-120-277VIES	ERL1_04B330_-347-480VIES	ERL1_04B327_-120-277VIES	ERL1_04B327_-347-480VIES
	C3						B1-U0-G1	B1-U0-G1	B1-U0-G1	ERL1_04C340_-120-277VIES	ERL1_04C340_-347-480VIES	ERL1_04C330_-120-277VIES	ERL1_04C330_-347-480VIES	ERL1_04C327_-120-277VIES	ERL1_04C327_-347-480VIES
	D3						B1-U0-G1	B1-U0-G1	B1-U0-G1	ERL1_04D340_-120-277VIES	ERL1_04D340_-347-480VIES	ERL1_04D330_-120-277VIES	ERL1_04D330_-347-480VIES	ERL1_04D327_-120-277VIES	ERL1_04D327_-347-480VIES
	E3						B1-U0-G1	B1-U0-G1	B1-U0-G1	ERL1_04E340_-120-277VIES	ERL1_04E340_-347-480VIES	ERL1_04E330_-120-277VIES	ERL1_04E330_-347-480VIES	ERL1_04E327_-120-277VIES	ERL1_04E327_-347-480VIES
05	A3	5000	4900	4700	39	43	B1-U0-G1	B1-U0-G1	B1-U0-G1	ERL1_05A340_-120-277VIES	ERL1_05A340_-347-480VIES	ERL1_05A330_-120-277VIES	ERL1_05A330_-347-480VIES	ERL1_05A327_-120-277VIES	ERL1_05A327_-347-480VIES
	B3						B1-U0-G1	B1-U0-G1	B1-U0-G1	ERL1_05B340_-120-277VIES	ERL1_05B340_-347-480VIES	ERL1_05B330_-120-277VIES	ERL1_05B330_-347-480VIES	ERL1_05B327_-120-277VIES	ERL1_05B327_-347-480VIES
	C3						B1-U0-G2	B1-U0-G2	B1-U0-G2	ERL1_05C340_-120-277VIES	ERL1_05C340_-347-480VIES	ERL1_05C330_-120-277VIES	ERL1_05C330_-347-480VIES	ERL1_05C327_-120-277VIES	ERL1_05C327_-347-480VIES
	D3						B1-U0-G1	B1-U0-G1	B1-U0-G1	ERL1_05D340_-120-277VIES	ERL1_05D340_-347-480VIES	ERL1_05D330_-120-277VIES	ERL1_05D330_-347-480VIES	ERL1_05D327_-120-277VIES	ERL1_05D327_-347-480VIES
	E3						B2-U0-G2	B1-U0-G1	B1-U0-G1	ERL1_05E340_-120-277VIES	ERL1_05E340_-347-480VIES	ERL1_05E330_-120-277VIES	ERL1_05E330_-347-480VIES	ERL1_05E327_-120-277VIES	ERL1_05E327_-347-480VIES
06	A3	6000	5800	5700	47	52	B2-U0-G2	B2-U0-G2	B2-U0-G2	ERL1_06A340_-120-277VIES	ERL1_06A340_-347-480VIES	ERL1_06A330_-120-277VIES	ERL1_06A330_-347-480VIES	ERL1_06A327_-120-277VIES	ERL1_06A327_-347-480VIES
	B3						B1-U0-G2	B1-U0-G2	B1-U0-G2	ERL1_06B340_-120-277VIES	ERL1_06B340_-347-480VIES	ERL1_06B330_-120-277VIES	ERL1_06B330_-347-480VIES	ERL1_06B327_-120-277VIES	ERL1_06B327_-347-480VIES
	C3						B1-U0-G2	B1-U0-G2	B1-U0-G2	ERL1_06C340_-120-277VIES	ERL1_06C340_-347-480VIES	ERL1_06C330_-120-277VIES	ERL1_06C330_-347-480VIES	ERL1_06C327_-120-277VIES	ERL1_06C327_-347-480VIES
	D3						B1-U0-G2	B1-U0-G2	B1-U0-G2	ERL1_06D340_-120-277VIES	ERL1_06D340_-347-480VIES	ERL1_06D330_-120-277VIES	ERL1_06D330_-347-480VIES	ERL1_06D327_-120-277VIES	ERL1_06D327_-347-480VIES
	E3						B2-U0-G2	B2-U0-G2	B2-U0-G2	ERL1_06E340_-120-277VIES	ERL1_06E340_-347-480VIES	ERL1_06E330_-120-277VIES	ERL1_06E330_-347-480VIES	ERL1_06E327_-120-277VIES	ERL1_06E327_-347-480VIES
07	A3	7000	6800	6600	58	B2-U0-G2	B2-U0-G2	B2-U0-G2	ERL1_07A340_-120-277VIES	ERL1_07A340_-347-480VIES	ERL1_07A330_-120-277VIES	ERL1_07A330_-347-480VIES	ERL1_07A327_-120-277VIES	ERL1_07A327_-347-480VIES	
	B3					B1-U0-G2	B1-U0-G2	B1-U0-G2	ERL1_07B340_-120-277VIES	ERL1_07B340_-347-480VIES	ERL1_07B330_-120-277VIES	ERL1_07B330_-347-480VIES	ERL1_07B327_-120-277VIES	ERL1_07B327_-347-480VIES	
	C3					B1-U0-G2	B1-U0-G2	B1-U0-G2	ERL1_07C340_-120-277VIES	ERL1_07C340_-347-480VIES	ERL1_07C330_-120-277VIES	ERL1_07C330_-347-480VIES	ERL1_07C327_-120-277VIES	ERL1_07C327_-347-480VIES	
	D3					B1-U0-G2	B1-U0-G2	B1-U0-G2	ERL1_07D340_-120-277VIES	ERL1_07D340_-347-480VIES	ERL1_07D330_-120-277VIES	ERL1_07D330_-347-480VIES	ERL1_07D327_-120-277VIES	ERL1_07D327_-347-480VIES	
	E3					B2-U0-G2	B2-U0-G2	B2-U0-G2	ERL1_07E340_-120-277VIES	ERL1_07E340_-347-480VIES	ERL1_07E330_-120-277VIES	ERL1_07E330_-347-480VIES	ERL1_07E327_-120-277VIES	ERL1_07E327_-347-480VIES	
08	A3	8000	7800	7600	71	B2-U0-G2	B2-U0-G2	B2-U0-G2	ERL1_08A340_-120-277VIES	ERL1_08A340_-347-480VIES	ERL1_08A330_-120-277VIES	ERL1_08A330_-347-480VIES	ERL1_08A327_-120-277VIES	ERL1_08A327_-347-480VIES	
	B3					B2-U0-G2	B2-U0-G2	B2-U0-G2	ERL1_08B340_-120-277VIES	ERL1_08B340_-347-480VIES	ERL1_08B330_-120-277VIES	ERL1_08B330_-347-480VIES	ERL1_08B327_-120-277VIES	ERL1_08B327_-347-480VIES	
	C3					B1-U0-G2	B1-U0-G2	B1-U0-G2	ERL1_08C340_-120-277VIES	ERL1_08C340_-347-480VIES	ERL1_08C330_-120-277VIES	ERL1_08C330_-347-480VIES	ERL1_08C327_-120-277VIES	ERL1_08C327_-347-480VIES	
	D3					B1-U0-G2	B1-U0-G2	B1-U0-G2	ERL1_08D340_-120-277VIES	ERL1_08D340_-347-480VIES	ERL1_08D330_-120-277VIES	ERL1_08D330_-347-480VIES	ERL1_08D327_-120-277VIES	ERL1_08D327_-347-480VIES	
	E3					B2-U0-G2	B2-U0-G2	B2-U0-G2	ERL1_08E340_-120-277VIES	ERL1_08E340_-347-480VIES	ERL1_08E330_-120-277VIES	ERL1_08E330_-347-480VIES	ERL1_08E327_-120-277VIES	ERL1_08E327_-347-480VIES	
09	A3	9000	8800	8500	84	B2-U0-G2	B2-U0-G2	B2-U0-G2	ERL1_09A340_-120-277VIES	ERL1_09A340_-347-480VIES	ERL1_09A330_-120-277VIES	ERL1_09A330_-347-480VIES	ERL1_09A327_-120-277VIES	ERL1_09A327_-347-480VIES	
	B3					B2-U0-G2	B2-U0-G2	B2-U0-G2	ERL1_09B340_-120-277VIES	ERL1_09B340_-347-480VIES	ERL1_09B330_-120-277VIES	ERL1_09B330_-347-480VIES	ERL1_09B327_-120-277VIES	ERL1_09B327_-347-480VIES	
	C3					B1-U0-G2	B1-U0-G2	B1-U0-G2	ERL1_09C340_-120-277VIES	ERL1_09C340_-347-480VIES	ERL1_09C330_-120-277VIES	ERL1_09C330_-347-480VIES	ERL1_09C327_-120-277VIES	ERL1_09C327_-347-480VIES	
	D3					B1-U0-G2	B1-U0-G2	B1-U0-G2	ERL1_09D340_-120-277VIES	ERL1_09D340_-347-480VIES	ERL1_09D330_-120-277VIES	ERL1_09D330_-347-480VIES	ERL1_09D327_-120-277VIES	ERL1_09D327_-347-480VIES	
	E3					B2-U0-G2	B2-U0-G2	B2-U0-G2	ERL1_09E340_-120-277VIES	ERL1_09E340_-347-480VIES	ERL1_09E330_-120-277VIES	ERL1_09E330_-347-480VIES	ERL1_09E327_-120-277VIES	ERL1_09E327_-347-480VIES	
10	A3	9800	9600	9250	97	B2-U0-G2	B2-U0-G2	B2-U0-G2	ERL1_10A340_-120-277VIES	ERL1_10A340_-347-480VIES	ERL1_10A330_-120-277VIES	ERL1_10A330_-347-480VIES	ERL1_10A327_-120-277VIES	ERL1_10A327_-347-480VIES	
	B3					B2-U0-G2	B2-U0-G2	B2-U0-G2	ERL1_10B340_-120-277VIES	ERL1_10B340_-347-480VIES	ERL1_10B330_-120-277VIES	ERL1_10B330_-347-480VIES	ERL1_10B327_-120-277VIES	ERL1_10B327_-347-480VIES	
	C3					B2-U0-G2	B2-U0-G2	B2-U0-G2	ERL1_10C340_-120-277VIES	ERL1_10C340_-347-480VIES	ERL1_10C330_-120-277VIES	ERL1_10C330_-347-480VIES	ERL1_10C327_-120-277VIES	ERL1_10C327_-347-480VIES	
	D3					B1-U0-G2	B1-U0-G2	B1-U0-G2	ERL1_10D340_-120-277VIES	ERL1_10D340_-347-480VIES	ERL1_10D330_-120-277VIES	ERL1_10D330_-347-480VIES	ERL1_10D327_-120-277VIES	ERL1_10D327_-347-480VIES	
	E3					B2-U0-G2	B2-U0-G2	B2-U0-G2	ERL1_10E340_-120-277VIES	ERL1_10E340_-347-480VIES	ERL1_10E330_-120-277VIES	ERL1_10E330_-347-480VIES	ERL1_10E327_-120-277VIES	ERL1_10E327_-347-480VIES	

Photometrics:

Evolve® LED Streetlight (ERL1)

ERL1

Type II Narrow
(05A340)

5,000 Lumens
4000K
ERL1_05A340____.IES

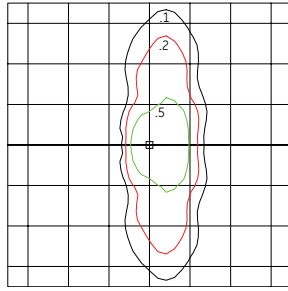

Grid Distance in Units of Mounting Height at 30'
Initial Footcandle Values at Grade

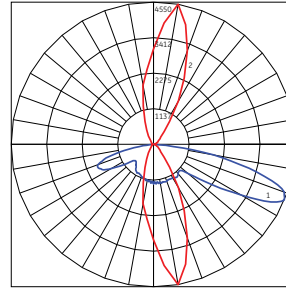

— Vertical plane through horizontal angle of Max. Cd at 80°
— Horizontal cone through vertical angle of Max. Cd at 67°

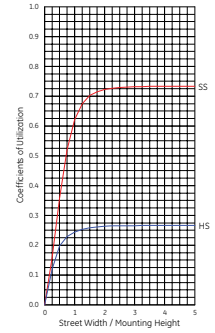

ERL1

Type II Wide
(05B340)

5,000 Lumens
4000K
ERL1_05B340____.IES

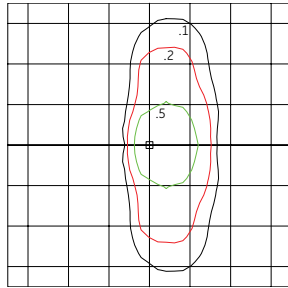

Grid Distance in Units of Mounting Height at 30'
Initial Footcandle Values at Grade

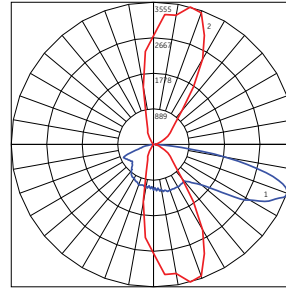

— Vertical plane through horizontal angle of Max. Cd at 75°
— Horizontal cone through vertical angle of Max. Cd at 69°

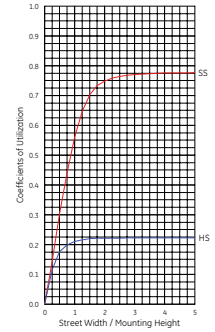

ERL1

Type III
(05C340)

5,000 Lumens
4000K
ERL1_05C340____.IES

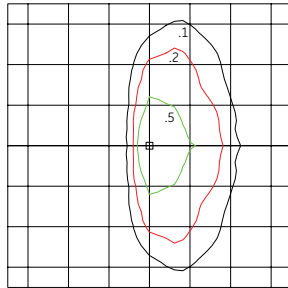

Grid Distance in Units of Mounting Height at 30'
Initial Footcandle Values at Grade

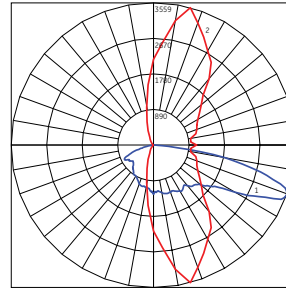

— Vertical plane through horizontal angle of Max. Cd at 75°
— Horizontal cone through vertical angle of Max. Cd at 70°

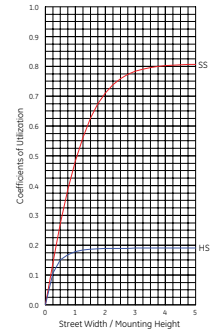

ERL1

Type IV
(05D340)

5,000 Lumens
4000K
ERL1_(05D340)____.IES

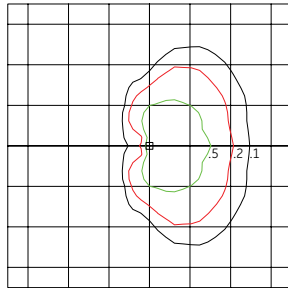

Grid Distance in Units of Mounting Height at 30'
Initial Footcandle Values at Grade

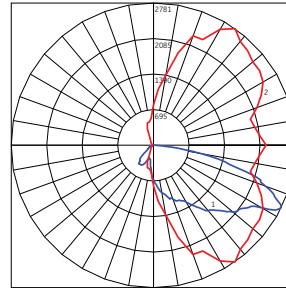

— Vertical plane through horizontal angle of Max. Cd at 55°
— Horizontal cone through vertical angle of Max. Cd at 64°

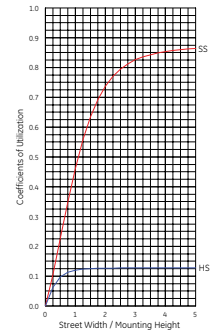

ERL1

Type II Enhanced Back Light
(05E340)

5,000 Lumens
4000K
ERL1_(05E340)____.IES

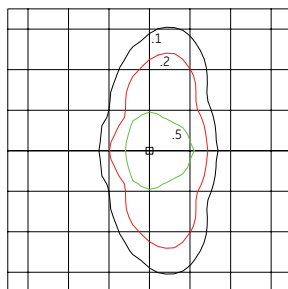

Grid Distance in Units of Mounting Height at 30'
Initial Footcandle Values at Grade

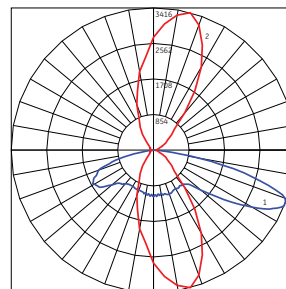

— Vertical plane through horizontal angle of Max. Cd at 75°
— Horizontal cone through vertical angle of Max. Cd at 67°

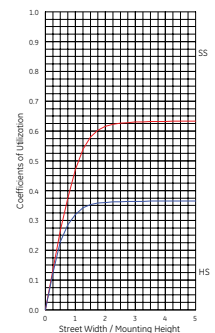

GE Evolve®

LED Roadway Lighting

ERL1-ERLH-ERL2



Project name _____

Date _____

Type _____

E R L H

PROD. ID	VOLTAGE	LUMEN OUTPUT	DISTRIBUTION*	CCT	CONTROLS	COLOR	OPTIONS
E = Evolve R = Roadway L = Local H = High Output	0 = 120-277V* 1 = 120 2 = 208 3 = 240 4 = 277 5 = 480 D = 347 H = 347-480*# * Not available with Fusing. Must choose a discrete voltage with F option. # Not available with E controls option.	10 11 13 14 15 16 See Table	A3 = Type II Narrow B3 = Type II Wide C3 = Type III D3 = Type IV E3 = Type II Enhanced Back Light See Table *Nominal IES Type classing subject to typical variation, individual units may differ.	27 = 2700K<> 30 = 3000K<> 40 = 4000K <> Select 2700K or 3000K CCT for IDA approved units.	A = ANSI C136.41 7-pin D = ANSI C136.41 7-pin with Shorting Cap E = ANSI C136.41 7-pin with non-Dimming PE Control.* *PE Control Only available for 120-277V or 480V Discrete. Not available for 347-480V or 347V Discrete. NOTE: Dimming controls wired for 0-10V standard unless DALI option "U" requested.	GRAY = Gray BLCK = Black DKBZ = Dark Bronze	A = 4 Bolt Slipfitter † F = Fusing G = Internal Bubble Level I = IP66 Optical L = Tool-Less Entry R = Secondary 10kV/5kA SPD T = Secondary 20kV/10kA SPD U = DALI Programmable +^ V1 = Variable Output via Field Adjustable Module** X = Single Package # Y = Coastal Finish* XXX = Special Options † Contact manufacturer for Lead-Time. # "X" option provides single pack box per fixture. Std Packaging = 20 units per Magna pak container. * Recommended for installations within 750 ft. from the coast. Contact Factory for Lead-Time. + Compatible with LightGrid 2.0 nodes. ^ Not available in 347V, 480V or 347-480V. ** Not available with DALI (U) option.

LUMEN OUTPUT	DISTRIBUTION	TYPICAL INITIAL LUMENS			TYPICAL SYSTEM WATTAGE		BUG RATING			IES FILE NUMBER		
		4000K	3000K	2700K	120-277V	347-480V	4000K	3000K	2700K	4000K	3000K	2700K
10	A3	10000	9600	9300	82	B2-U0-G2	B2-U0-G2	B2-U0-G2	ERLH_10A340	ERLH_10A330	ERLH_10A327	
	B3					B2-U0-G2	B2-U0-G2	B2-U0-G2	ERLH_10B340	ERLH_10B330	ERLH_10B327	
	C3					B2-U0-G3	B2-U0-G3	B2-U0-G3	ERLH_10C340	ERLH_10C330	ERLH_10C327	
	D3					B1-U0-G3	B1-U0-G3	B1-U0-G3	ERLH_10D340	ERLH_10D330	ERLH_10D327	
	E3					B3-U0-G3	B3-U0-G3	B3-U0-G3	ERLH_10E340	ERLH_10E330	ERLH_10E327	
11	A3	11500	11000	10700	98	B3-U0-G3	B2-U0-G2	B2-U0-G2	ERLH_11A340	ERLH_11A330	ERLH_11A327	
	B3					B2-U0-G2	B2-U0-G2	B2-U0-G2	ERLH_11B340	ERLH_11B330	ERLH_11B327	
	C3					B2-U0-G3	B2-U0-G3	B2-U0-G3	ERLH_11C340	ERLH_11C330	ERLH_11C327	
	D3					B1-U0-G3	B1-U0-G2	B1-U0-G2	ERLH_11D340	ERLH_11D330	ERLH_11D327	
	E3					B3-U0-G3	B3-U0-G3	B3-U0-G3	ERLH_11E340	ERLH_11E330	ERLH_11E327	
13	A3	13000	12500	12100	111	B3-U0-G3	B3-U0-G3	B3-U0-G3	ERLH_13A340	ERLH_13A330	ERLH_13A327	
	B3					B2-U0-G3	B2-U0-G3	B2-U0-G3	ERLH_13B340	ERLH_13B330	ERLH_13B327	
	C3					B2-U0-G3	B2-U0-G3	B2-U0-G3	ERLH_13C340	ERLH_13C330	ERLH_13C327	
	D3					B2-U0-G3	B2-U0-G3	B1-U0-G3	ERLH_13D340	ERLH_13D330	ERLH_13D327	
	E3					B3-U0-G3	B3-U0-G3	B3-U0-G3	ERLH_13E340	ERLH_13E330	ERLH_13E327	
14	A3	14000	13400	13000	122	B3-U0-G3	B3-U0-G3	B3-U0-G3	ERLH_14A340	ERLH_14A330	ERLH_14A327	
	B3					B2-U0-G3	B2-U0-G3	B2-U0-G3	ERLH_14B340	ERLH_14B330	ERLH_14B327	
	C3					B2-U0-G3	B2-U0-G3	B2-U0-G3	ERLH_14C340	ERLH_14C330	ERLH_14C327	
	D3					B2-U0-G3	B2-U0-G3	B2-U0-G3	ERLH_14D340	ERLH_14D330	ERLH_14D327	
	E3					B3-U0-G3	B3-U0-G3	B3-U0-G3	ERLH_14E340	ERLH_14E330	ERLH_14E327	
15	A3	15000	14400	13900	136	B3-U0-G3	B3-U0-G3	B3-U0-G3	ERLH_15A340	ERLH_15A330	ERLH_15A327	
	B3					B2-U0-G3	B2-U0-G3	B2-U0-G3	ERLH_15B340	ERLH_15B330	ERLH_15B327	
	C3					B2-U0-G3	B2-U0-G3	B2-U0-G3	ERLH_15C340	ERLH_15C330	ERLH_15C327	
	D3					B2-U0-G3	B2-U0-G3	B2-U0-G3	ERLH_15D340	ERLH_15D330	ERLH_15D327	
	E3					B3-U0-G3	B3-U0-G3	B3-U0-G3	ERLH_15E340	ERLH_15E330	ERLH_15E327	
16	A3	16000	15300	14900	149	B3-U0-G3	B3-U0-G3	B3-U0-G3	ERLH_16A340	ERLH_16A330	ERLH_16A327	
	B3					B3-U0-G3	B2-U0-G3	B2-U0-G3	ERLH_16B340	ERLH_16B330	ERLH_16B327	
	C3					B2-U0-G3	B2-U0-G3	B2-U0-G3	ERLH_16C340	ERLH_16C330	ERLH_16C327	
	D3					B2-U0-G3	B2-U0-G3	B2-U0-G3	ERLH_16D340	ERLH_16D330	ERLH_16D327	
	E3					B3-U0-G3	B3-U0-G3	B3-U0-G3	ERLH_16E340	ERLH_16E330	ERLH_16E327	

Photometrics:

Evolve® LED Streetlight (ERLH)

ERLH

Type II Narrow
(13A340)

13,000 Lumens
4000K
ERLH_13A340__IES

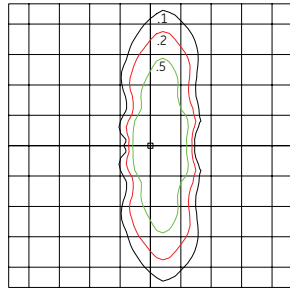

Grid Distance in Units of Mounting Height at 30'
Initial Footcandle Values at Grade

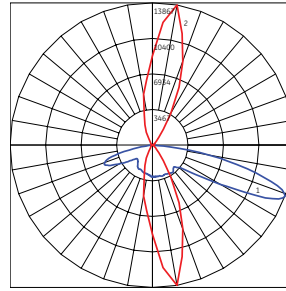

— Vertical plane through horizontal angle of Max. Cd at 80°
— Horizontal cone through vertical angle of Max. Cd at 69°

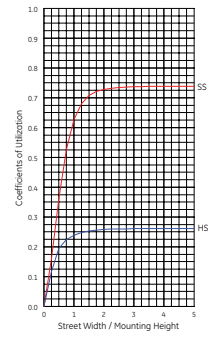

ERLH

Type II Wide
(13B340)

13,000 Lumens
4000K
ERLH_13B340__IES

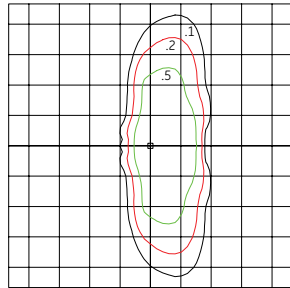

Grid Distance in Units of Mounting Height at 30'
Initial Footcandle Values at Grade

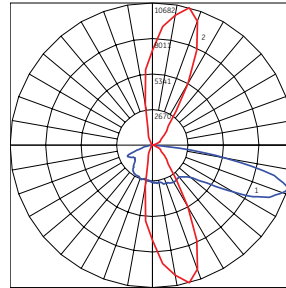

— Vertical plane through horizontal angle of Max. Cd at 75°
— Horizontal cone through vertical angle of Max. Cd at 72°

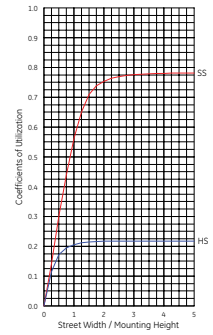

ERLH

Type III
(13C340)

13,000 Lumens
4000K
ERLH_13C340__IES

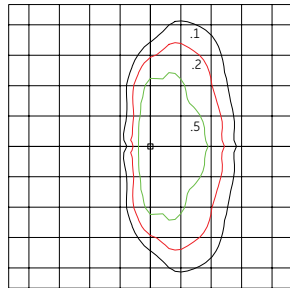

Grid Distance in Units of Mounting Height at 30'
Initial Footcandle Values at Grade

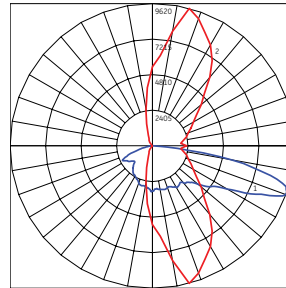

— Vertical plane through horizontal angle of Max. Cd at 75°
— Horizontal cone through vertical angle of Max. Cd at 71°

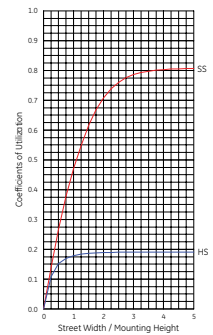

ERLH

Type IV
13D340

13,000 Lumens
4000K
ERLH_13D340__IES

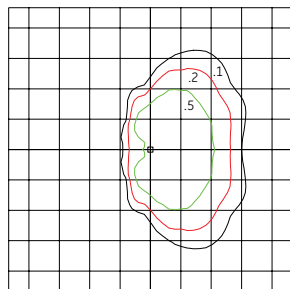

Grid Distance in Units of Mounting Height at 30'
Initial Footcandle Values at Grade

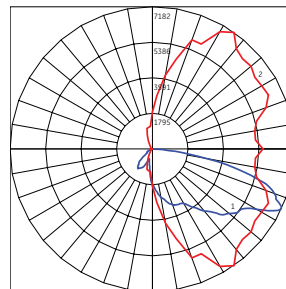

— Vertical plane through horizontal angle of Max. Cd at 55°
— Horizontal cone through vertical angle of Max. Cd at 65°

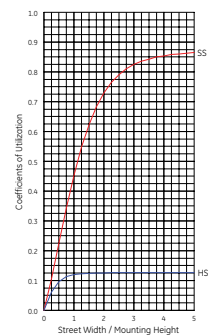

ERLH

Type II Enhanced Back Light
13E340

13,000 Lumens
4000K
ERLH_13E340__IES

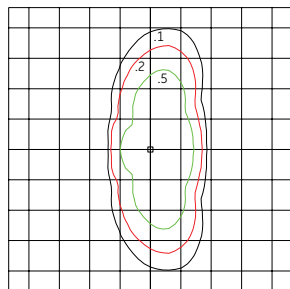

Grid Distance in Units of Mounting Height at 30'
Initial Footcandle Values at Grade

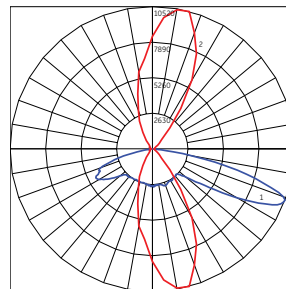

— Vertical plane through horizontal angle of Max. Cd at 75°
— Horizontal cone through vertical angle of Max. Cd at 69°

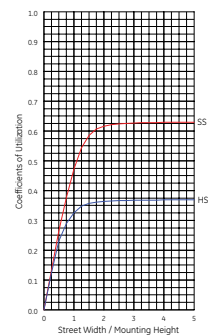



Project name _____

Date _____

Type _____

ERL2

PROD. ID	VOLTAGE	LUMEN OUTPUT	DISTRIBUTION*	CCT	CONTROLS	COLOR	OPTIONS
E = Evolve	0 = 120-277V*	16	A3 = Type II Narrow	27 = 2700K <>	A = ANSI C136.41 7-pin	GRAY = Gray	A = 4 Bolt Slipfitter †
R = Roadway	1 = 120	18	B3 = Type II Wide	30 = 3000K <>	D = ANSI C136.41 7-pin with Shorting Cap	BLK = Black	F = Fusing
L = Local	2 = 208	19	C3 = Type III	40 = 4000K	E = ANSI C136.41 7-pin with non-Dimming PE Control.*	DKBZ = Dark Bronze	G = Internal Bubble Level
2 = Double Module	3 = 240	21	D3 = Type IV	<> Select 2700K or 3000K CCT for IDA approved units.	*PE Control Only available for 120-277V or 480V Discrete. Not available for 347-480V or 347V Discrete.		I = IP66 Optical
	4 = 277	23	E3 = Type II Enhanced Back Light		NOTE: Dimming controls wired for 0-10V standard unless DALI option "U" requested.		L = Tool-Less Entry
	5 = 480	25	See Table				M1 = Magnapack***
	D = 347	27	*Nominal IES Type classing subject to typical variation, individual units may differ.				R = Secondary 10kV/5kA SPD
	H = 347-480*#	28					T = Secondary 20kV/10kA SPD
		30					U = DALI Programmable ^
	* Not available with Fusing. Must choose a discrete voltage with F option. # Not available with E controls option.	See Table					V1 = Variable Output via Field Adjustable Module**
							Y = Coastal Finish*
							XXX = Special Options

† Contact manufacturer for Lead-Time.
* Recommended for installations within 750 ft. from the coast. Contact Factory for Lead-Time.
+ Compatible with LightGrid 2.0 nodes.
^ Not available in 347V, 480V or 347-480V.
** Not available with DALI (U) option.
*** 20 fixtures per Magnapack.

LUMEN OUTPUT	DISTRIBUTION	TYPICAL INITIAL LUMENS			TYPICAL SYSTEM WATTAGE		BUG RATING			IES FILE NUMBER											
		4000K	3000K	2700K	120-277V	347-480V	4000K	3000K	2700K	4000K		3000K		2700K							
										120-277V	347-480V	120-277V	347-480V	120-277V	347-480V						
16	A3	16000	15300	14900	120		B3-U0-G3	B3-U0-G3	B2-U0-G3	ERL2_16A340_IES						ERL2_16A330_IES		ERL2_16A327_IES			
	B3									ERL2_16B340_IES						ERL2_16B330_IES		ERL2_16B327_IES			
	C3									ERL2_16C340_IES						ERL2_16C330_IES		ERL2_16C327_IES			
	D3									ERL2_16D340_IES						ERL2_16D330_IES		ERL2_16D327_IES			
	E3									ERL2_16E340_IES						ERL2_16E330_IES		ERL2_16E327_IES			
18	A3	18000	17300	16700	140		B3-U0-G3	B3-U0-G3	B2-U0-G3	ERL2_18A340_IES						ERL2_18A330_IES		ERL2_18A327_IES			
	B3									ERL2_18B340_IES						ERL2_18B330_IES		ERL2_18B327_IES			
	C3									ERL2_18C340_IES						ERL2_18C330_IES		ERL2_18C327_IES			
	D3									ERL2_18D340_IES						ERL2_18D330_IES		ERL2_18D327_IES			
	E3									ERL2_18E340_IES						ERL2_18E330_IES		ERL2_18E327_IES			
19	A3	19000	18200	17700	149		B3-U0-G3	B3-U0-G3	B2-U0-G3	ERL2_19A340_IES						ERL2_19A330_IES		ERL2_19A327_IES			
	B3									ERL2_19B340_IES						ERL2_19B330_IES		ERL2_19B327_IES			
	C3									ERL2_19C340_IES						ERL2_19C330_IES		ERL2_19C327_IES			
	D3									ERL2_19D340_IES						ERL2_19D330_IES		ERL2_19D327_IES			
	E3									ERL2_19E340_IES						ERL2_19E330_IES		ERL2_19E327_IES			
21	A3	21000	20100	19500	174	177	B3-U0-G3	B3-U0-G3	B2-U0-G3	ERL2_21A340_120-277VIES		ERL2_21A340_347-480VIES		ERL2_21A330_120-277VIES		ERL2_21A330_347-480VIES		ERL2_21A327_120-277VIES		ERL2_21A327_347-480VIES	
	B3									ERL2_21B340_120-277VIES		ERL2_21B340_347-480VIES		ERL2_21B330_120-277VIES		ERL2_21B330_347-480VIES		ERL2_21B327_120-277VIES		ERL2_21B327_347-480VIES	
	C3									ERL2_21C340_120-277VIES		ERL2_21C340_347-480VIES		ERL2_21C330_120-277VIES		ERL2_21C330_347-480VIES		ERL2_21C327_120-277VIES		ERL2_21C327_347-480VIES	
	D3									ERL2_21D340_120-277VIES		ERL2_21D340_347-480VIES		ERL2_21D330_120-277VIES		ERL2_21D330_347-480VIES		ERL2_21D327_120-277VIES		ERL2_21D327_347-480VIES	
	E3									ERL2_21E340_120-277VIES		ERL2_21E340_347-480VIES		ERL2_21E330_120-277VIES		ERL2_21E330_347-480VIES		ERL2_21E327_120-277VIES		ERL2_21E327_347-480VIES	
23	A3	23000	22100	21400	194	196	B3-U0-G3	B3-U0-G3	B2-U0-G3	ERL2_23A340_120-277VIES		ERL2_23A340_347-480VIES		ERL2_23A330_120-277VIES		ERL2_23A330_347-480VIES		ERL2_23A327_120-277VIES		ERL2_23A327_347-480VIES	
	B3									ERL2_23B340_120-277VIES		ERL2_23B340_347-480VIES		ERL2_23B330_120-277VIES		ERL2_23B330_347-480VIES		ERL2_23B327_120-277VIES		ERL2_23B327_347-480VIES	
	C3									ERL2_23C340_120-277VIES		ERL2_23C340_347-480VIES		ERL2_23C330_120-277VIES		ERL2_23C330_347-480VIES		ERL2_23C327_120-277VIES		ERL2_23C327_347-480VIES	
	D3									ERL2_23D340_120-277VIES		ERL2_23D340_347-480VIES		ERL2_23D330_120-277VIES		ERL2_23D330_347-480VIES		ERL2_23D327_120-277VIES		ERL2_23D327_347-480VIES	
	E3									ERL2_23E340_120-277VIES		ERL2_23E340_347-480VIES		ERL2_23E330_120-277VIES		ERL2_23E330_347-480VIES		ERL2_23E327_120-277VIES		ERL2_23E327_347-480VIES	
25	A3	25000	24000	23300	214		B3-U0-G3	B3-U0-G3	B2-U0-G3	ERL2_25A340_IES						ERL2_25A330_IES		ERL2_25A327_IES			
	B3									ERL2_25B340_IES						ERL2_25B330_IES		ERL2_25B327_IES			
	C3									ERL2_25C340_IES						ERL2_25C330_IES		ERL2_25C327_IES			
	D3									ERL2_25D340_IES						ERL2_25D330_IES		ERL2_25D327_IES			
	E3									ERL2_25E340_IES						ERL2_25E330_IES		ERL2_25E327_IES			
27	A3	27000	25900	25100	237		B3-U0-G3	B3-U0-G3	B2-U0-G3	ERL2_27A340_IES						ERL2_27A330_IES		ERL2_27A327_IES			
	B3									ERL2_27B340_IES						ERL2_27B330_IES		ERL2_27B327_IES			
	C3									ERL2_27C340_IES						ERL2_27C330_IES		ERL2_27C327_IES			
	D3									ERL2_27D340_IES						ERL2_27D330_IES		ERL2_27D327_IES			
	E3									ERL2_27E340_IES						ERL2_27E330_IES		ERL2_27E327_IES			
28	A3	28000	26900	26100	251		B3-U0-G3	B3-U0-G3	B2-U0-G3	ERL2_28A340_IES						ERL2_28A330_IES		ERL2_28A327_IES			
	B3									ERL2_28B340_IES						ERL2_28B330_IES		ERL2_28B327_IES			
	C3									ERL2_28C340_IES						ERL2_28C330_IES		ERL2_28C327_IES			
	D3									ERL2_28D340_IES						ERL2_28D330_IES		ERL2_28D327_IES			
	E3									ERL2_28E340_IES						ERL2_28E330_IES		ERL2_28E327_IES			
30	A3	30000	28800	27900	278		B4-U0-G4	B4-U0-G4	B3-U0-G3	ERL2_30A340_IES						ERL2_30A330_IES		ERL2_30A327_IES			
	B3									ERL2_30B340_IES						ERL2_30B330_IES		ERL2_30B327_IES			
	C3									ERL2_30C340_IES						ERL2_30C330_IES		ERL2_30C327_IES			
	D3									ERL2_30D340_IES						ERL2_30D330_IES		ERL2_30D327_IES			
	E3									ERL2_30E340_IES						ERL2_30E330_IES		ERL2_30E327_IES			

Photometrics: Evolve® LED Streetlight (ERL2)

ERL2

Type II Narrow
(23A340)

23,000 Lumens
4000K
ERL2_23A340___.IES

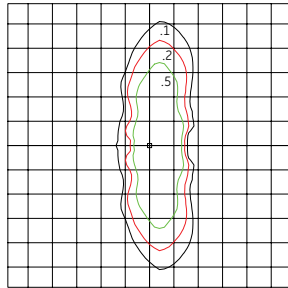

Grid Distance in Units of Mounting Height at 30'
Initial Footcandle Values at Grade

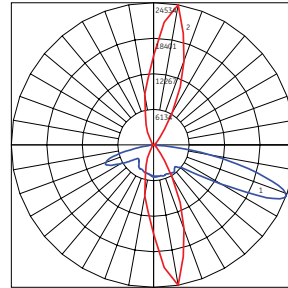

— Vertical plane through horizontal angle of Max. Cd at 80°
— Horizontal cone through vertical angle of Max. Cd at 69°

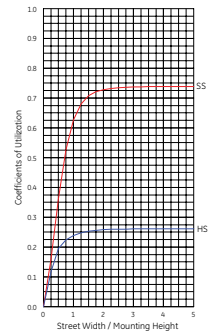

ERL2

Type II Wide
(23B340)

23,000 Lumens
4000K
ERL2_23B340___.IES

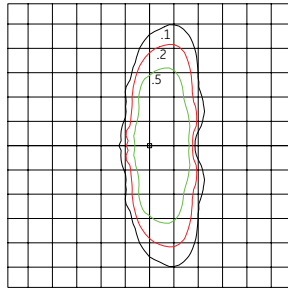

Grid Distance in Units of Mounting Height at 30'
Initial Footcandle Values at Grade

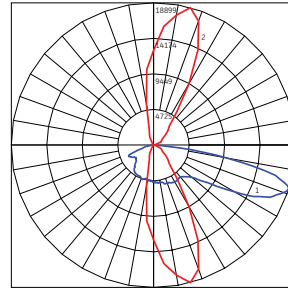

— Vertical plane through horizontal angle of Max. Cd at 75°
— Horizontal cone through vertical angle of Max. Cd at 72°

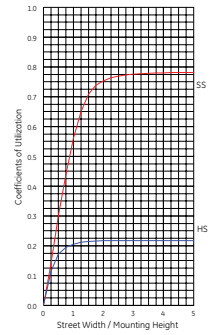

ERL2

Type III
(23C340)

23,000 Lumens
4000K
ERL2_23C340___.IES

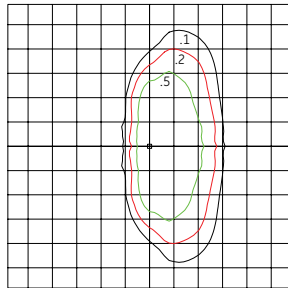

Grid Distance in Units of Mounting Height at 30'
Initial Footcandle Values at Grade

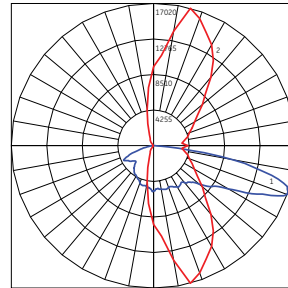

— Vertical plane through horizontal angle of Max. Cd at 75°
— Horizontal cone through vertical angle of Max. Cd at 71°

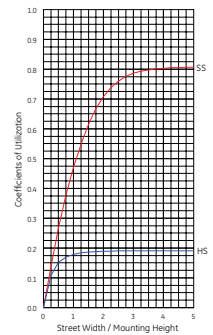

ERL2

Type IV
(23D340)

23,000 Lumens
4000K
ERL2_23D340___.IES

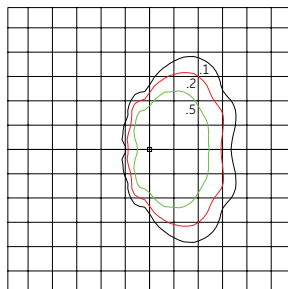

Grid Distance in Units of Mounting Height at 30'
Initial Footcandle Values at Grade

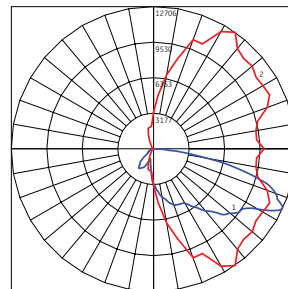

— Vertical plane through horizontal angle of Max. Cd at 55°
— Horizontal cone through vertical angle of Max. Cd at 65°

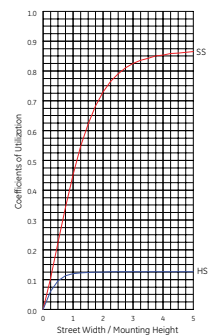

ERL2

Type II Enhanced Back Light
(23E340)

23,000 Lumens
4000K
ERL2_23E340___.IES

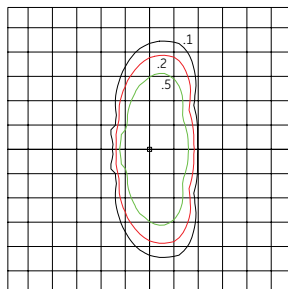

Grid Distance in Units of Mounting Height at 30'
Initial Footcandle Values at Grade

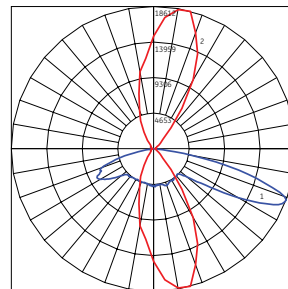

— Vertical plane through horizontal angle of Max. Cd at 75°
— Horizontal cone through vertical angle of Max. Cd at 69°

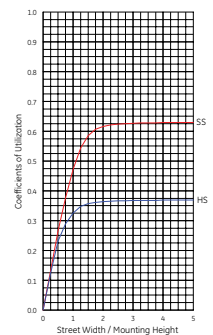

GE Evolve®
 LED Roadway Lighting
 ERL1-ERLH-ERL2

Product Dimensions:
 Evolve® LED Streetlight (ERL1)

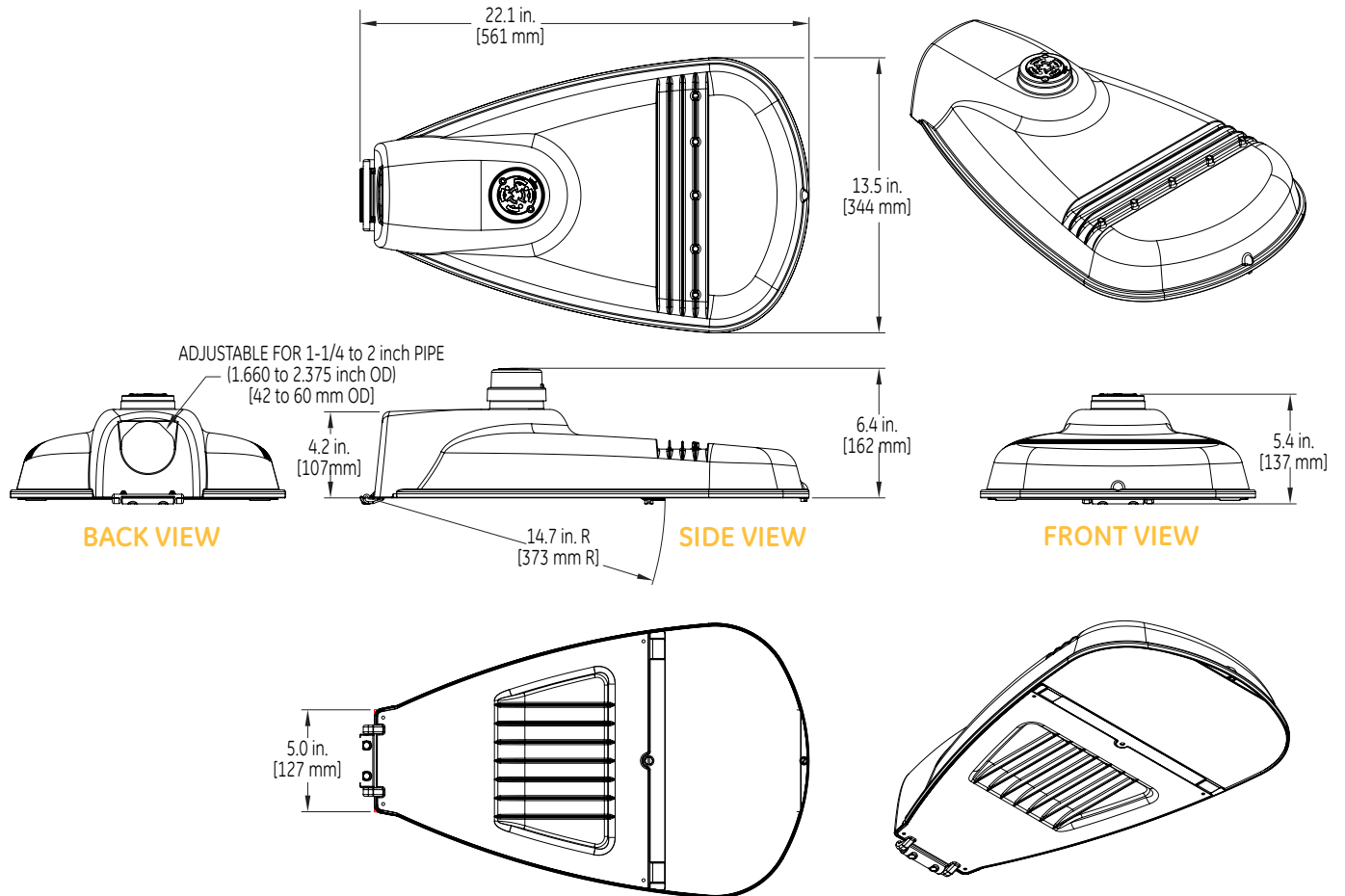

DATA

- Approximate net weight: 12.4 lbs (5.6kgs) -15.5 lbs (7.0kgs) with XFMR
- Effective Projected Area (EPA): 0.5 sq ft max (0.046 sq m)

GE Evolve®
 LED Roadway Lighting
 ERL1-ERLH-ERL2

Product Dimensions:
 Evolve® LED Streetlight (ERLH)

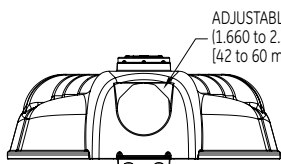
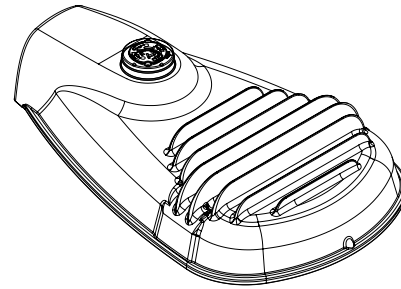
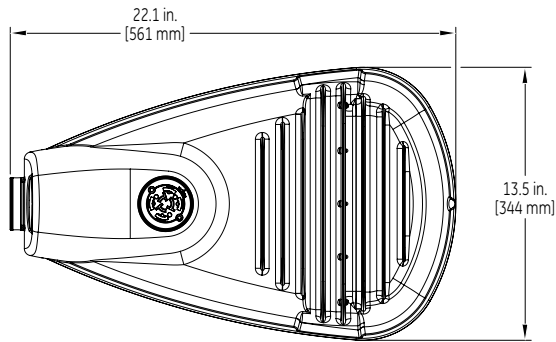

BACK VIEW

ADJUSTABLE FOR 1-1/4 to 2 inch PIPE
 (1.660 to 2.375 inch OD)
 (42 to 60 mm OD)

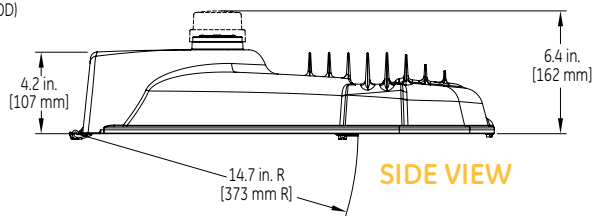

SIDE VIEW

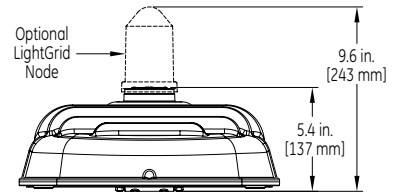

FRONT VIEW

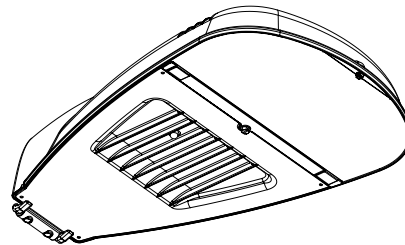
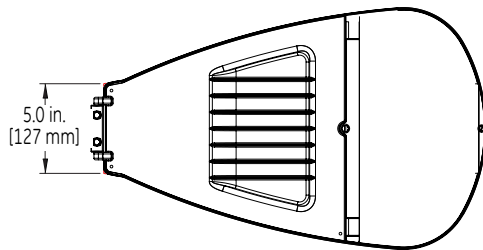

DATA	<ul style="list-style-type: none"> • Approximate net weight: 15.15 lbs (6.9 kgs) - 2 Bolt Slipfitter • Approximate net weight: 15.85 lbs (7.2 kgs) - 4 Bolt Slipfitter • Effective Projected Area (EPA): 0.5 sq ft max (0.046 sq m)
-------------	--

GE Evolve®
LED Roadway Lighting
 ERL1-ERLH-ERL2

Product Dimensions:
Evolve® LED Streetlight (ERL2)

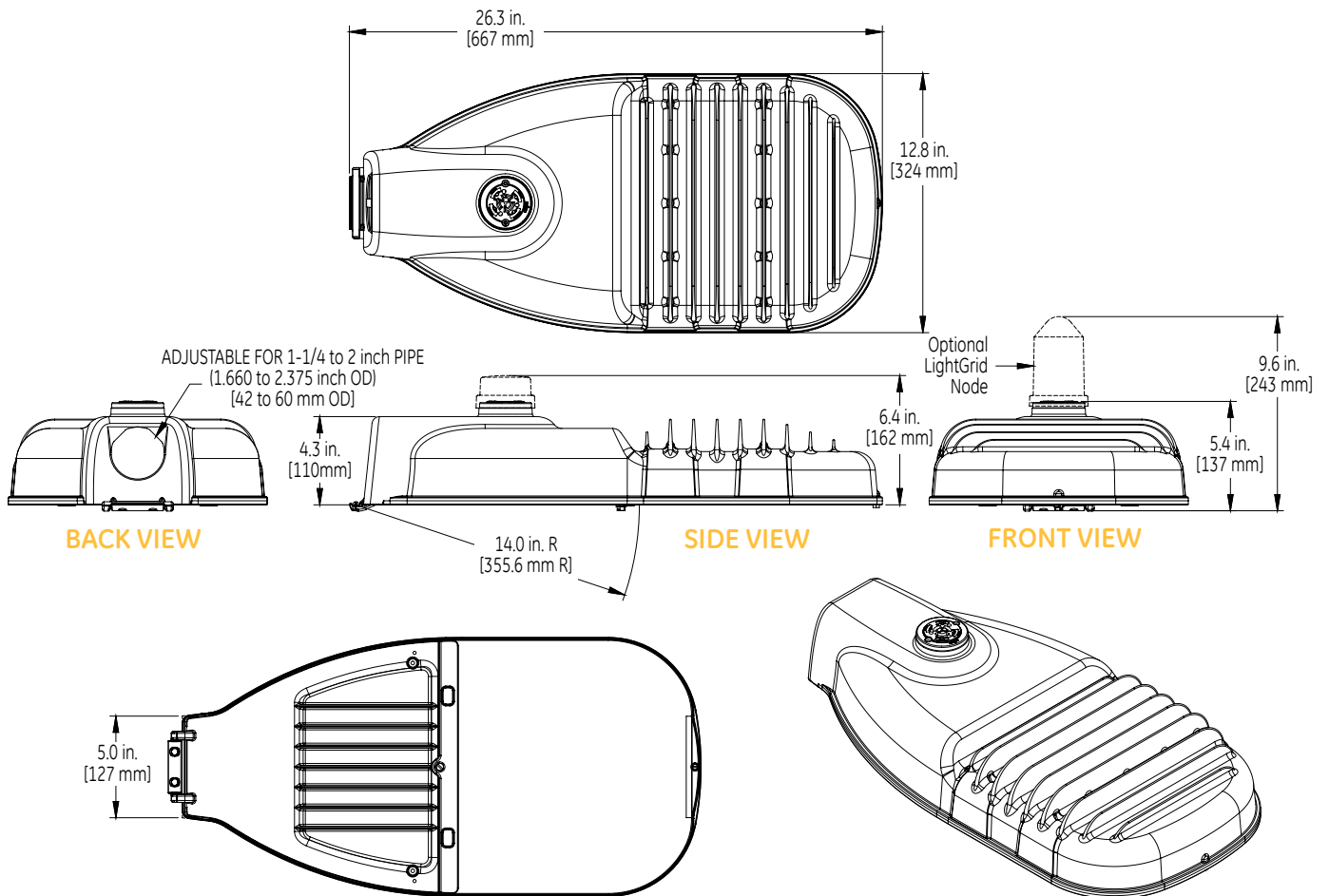

DATA

- Approximate net weight: 24.0 lbs (10.9 kgs)
 Contact manufacturer for specific configuration weight.
- Effective Projected Area (EPA): 0.57 sq ft max (0.053 sq m)

